

A. L. MABBET, REAL ESTATE,

Office, No. 32 Arcade (East Gallery), Rochester, N. Y.

Agency for the sale, purchase and care of REAL ESTATE. Real Estate collected, &c.

The Mutual Benefit Life Insurance Company

NEWARK, N. J.

ABNER GARDNER, Dist. Ag't, 32 Arcade.

LIFE AND ACCIDENT INSURANCE.

TRAVELERS' INSURANCE COMPANY,

HARTFORD, CONN.

PAID UP CASH CAPITAL, - - - \$600,0000

CASH ASSETS JAN. 1st, 1876, - - - \$3,701,3613

In Life Insurance, the acknowledged "leading Stock Company." All Cash Low Rates
In Accident, the original, largest, best. LOSSES PAID TO JAN. 1, 1876, \$25,102.39.

Rochester Office: No. 6 Elwood Block, State Street, cor. West Main.

G. HENRY ROBERTS, Manager.

CHARLES S. SIDDONS,

PLUMBER,

Gas, Steam and Water Pipe Fitter,

DEALER IN

FIRST CLASS SANITARY GOODS

OF EVERY DESCRIPTION.

FINE WORK A SPECIALTY.

Fountains, Vases and Aquarium Fountains,

96 EAST MAIN STREET,

CHAS. S. SIDDONS.

ROCHESTER, N. Y.

W. KING.

HEBARD'S STEAM MARBLE WORKS,

122 South St. Paul Street, Rochester, N. Y.

(ESTABLISHED 1831.)

Manufacturer and Dealer in
every variety of

Marble Work

INCLUDING

MONUMENTS,

Decorated Marble,

Slate and Marble Mantels,

Coal Grates, &c., &c.

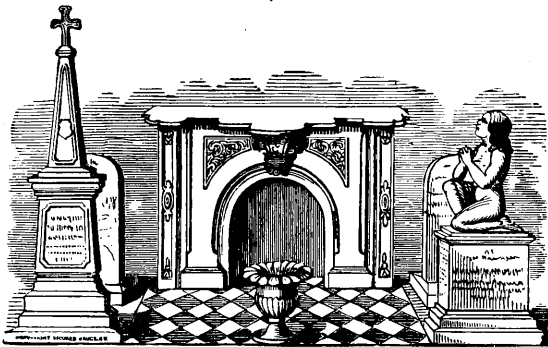

CEMETERY AND GARDEN IRON VASES.

HENRY S. HEBARD, Prop'r.

JOHN SIDDONS,

ARCHITECTURAL

Galvanized Iron Works,

IRON ROOFING, CORNICES,

Dormer Windows, Window Caps, Crestings, &c.

WORKER IN

HEAVY SHEET-IRON,

In all its Branches.

90 East Main Street,

2, 4, 6, 8 and 10 STONE STREET,

ROCHESTER, N. Y.

THE
DIRECTORY OFFICE,

(ESTABLISHED IN 1869.)

114 POWERS' BUILDINGS,

ROCHESTER, N. Y.

BRANCH OFFICE:
452 Main Street, Worcester, Mass. }

ROCHESTER DIRECTORY,
Price, \$3.

NEWTON DIRECTORY,
Price, \$1.50.

WORCESTER DIRECTORY.
Price, \$2.

*Besides the Publications issued from this office
are kept on hand*

DIRECTORIES OF THE PRINCIPAL CITIES

IN THE UNITED STATES,

For Sale at Publishers' Prices.

Persons who do not wish to be at the expense of buying Directories, will be furnished with Lists of Business Men in any trade or profession in any state, at reasonable rates.

☞ Circulars Printed, enclosed and Mailed.

CANVASSING

Done for Committees, Corporations and others, accurately and at short notice.

D., A. & Co. having been engaged for sixteen years in business of this nature, have facilities and experience for doing well whatever work is entrusted to them.

DREW, ALLIS & CO.,

Publishers and Statisticians,

CHARLES C. DREW, }
GARDNER S. ALLIS, }

114 Powers' Buildings.

MARTIN HUNTINGTON.

EDWIN HUNTINGTON.

M. & E. HUNTINGTON,

WHOLESALE AND RETAIL DEALERS IN

PAINTS, OILS, FINE COLORS,

Brushes, Artists' Materials, Wax Flower Materials,

PUTTY, VARNISHES, PLATE, SHEET AND ORNAMENTAL GLASS,
LARD AND SPERM OILS, SAND PAPER, &c.

ALSO, MANUFACTURERS OF

Doors, Sash, Blinds,

MOULDINGS and GLAZED WINDOWS,

Office and Salesroom, 36 E. Main St. Cor. Water St.

FACTORY, NORTH WATER STREET,

ROCHESTER, N. Y.

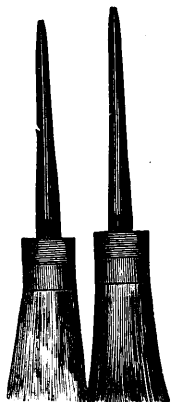

A. W. MUDGE,

FURNISHING

UNDERTAKER

COFFIN WAREROOMS,

No. 121 West Main Street,

ODD FELLOWS' TEMPLE.

RESIDENCE,

17 Atkinson Street,

ROCHESTER, N. Y.



DR. J. P. BRYANT, "The Magnetic Healer"

Offices, 148, 149 and 150 POWERS' BUILDINGS,
ROCHESTER, N. Y.

Known throughout the world for many years by his success in the cure of Disease by
Magnetic Treatment and Without Medicine.

The Most Successful Healer in the World!

The following diseases yield quickly to my method, and show its superiority over ALL OTHER modes of cure. viz :

Rheumatism,
Paralysis,
Female,
Spinal, Liver and
Kidney
Complaints,
Dropsy,
St. Vitus Dance,

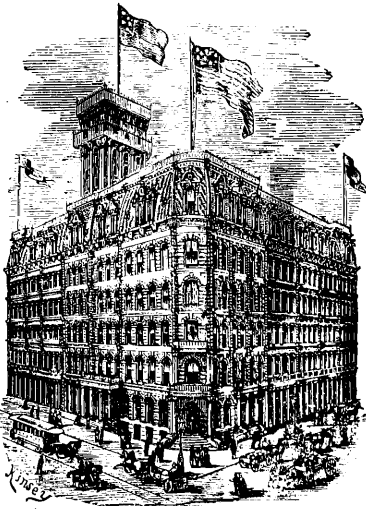

Enlarged and
Stiffened
Joints,
Contracted
Limbs and
Muscles,
&c., &c.

The SAFEST, QUICK-EST, MOST EFFECTUAL & AGREEABLE METHOD of treatment ever conceived of by the human mind.

Dr. Bryant's Magnetic Remedies,

SOLD BY ALL DRUGGISTS.

BRYANT'S RHUS WINE,

BEST TONIC FOR INVALIDS.

A new Therapeutic preparation for all Diseases of the Mucous Surfaces; the best known specific for Bronchitis, Diphtheria, and Dyspepsia; an invaluable remedy for Female Weaknesses, General Debility, Liver and Kidney Diseases, Rheumatism, and all Diseases of the NERVES AND BLOOD.

Endorsed by the Medical profession as the Best Wine for Invalids. A Healthful and Pleasant Beverage. Possesses the properties of both Rhus Glabrum and Citrate of Iron, and is admirably adapted for children and delicate females as a Blood Restorative and Tonic, and seldom fails to give strength to the weak.

— PRICE, \$1.50 PER BOTTLE. —

BRYANT'S MAGNETIC LINIMENT.—A certain cure for all kinds of Lameness, Weakness, Sprains, &c. Price, \$1.00 per bottle.

BRYANT'S LIVER PILLS.—The best Alternative in existence; and unlike the cheap Purgative Pills usually found at Drug stores. Price, \$1.00 per box.

All orders for these Medicines, addressed **DR. J. P. BRYANT, No. 150 Power's Building, Rochester, N. Y.**, will receive prompt attention.

BUFFALO
Steam Gauge & Lantern Co.,
Of Rochester, N. Y.

Office, No. 31 State Street.
Works, No. 11 Warehouse St., Rochester, N. Y.

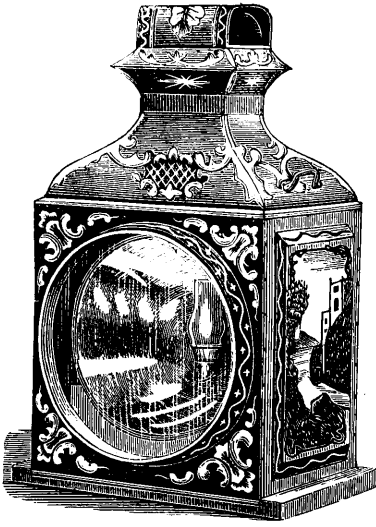

Locomotive Head Lights,
From 14 to 23 Inches.
A FULL STOCK OF GOODS ALWAYS ON HAND.
PATENT BOX OILERS.
STEAM GAUGES — High or Low Pressure,
Also, VACUUM GAUGES of any Dimension.

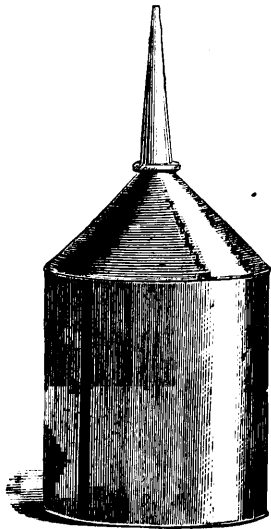
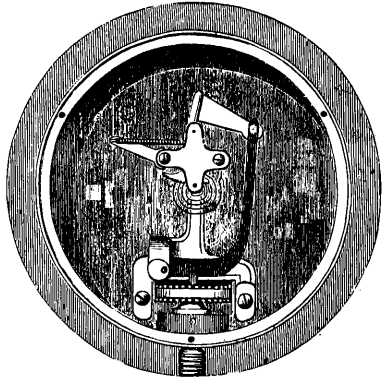
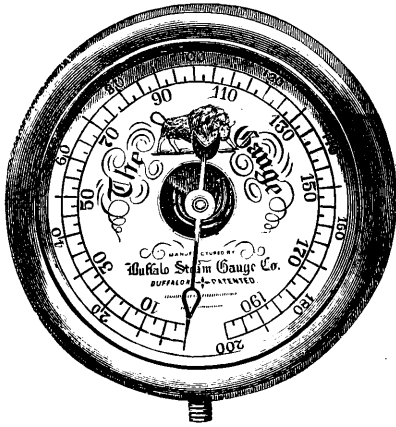

Railroad and Farmers' Lanterns.

— ALSO, —

Ship and Signal Lamps.

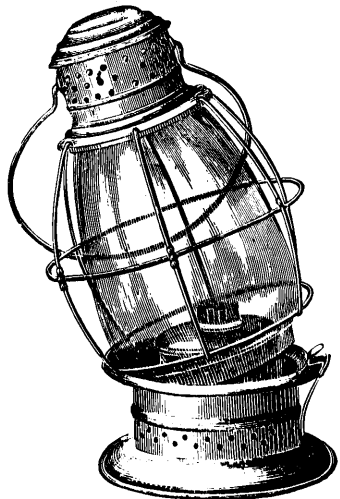

SARGENT & GREENLEAF,

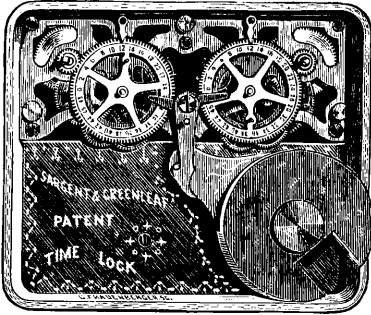

CUT OF BANK LOCK.

Patentees and Manufacturers of the

MAGNETIC, AUTOMATIC,

—AND—

CHRONOMETER BANK LOCKS,

COMBINATION SAFE LOCKS,

UNPICKABLE DRAWER,

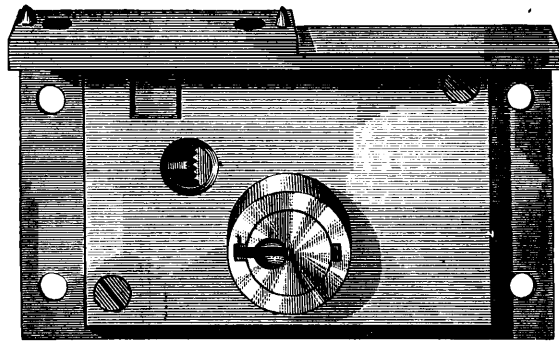

CUT OF DESK LOCK.

**TRUNK,
HOUSE,
STORE DOOR,**

AND OTHER

LOCKS, LATCHES, &C.,

With Small Flat Keys.

NICKEL PLATING

Done to Order.

Court Street, cor. Stone, Rochester, N. Y.

JAMES SARGENT.

H. S. GREENLEAF.

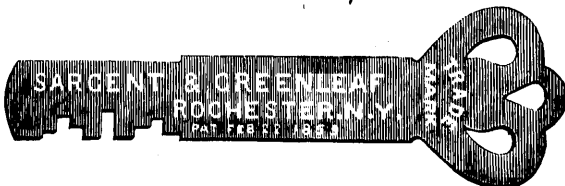

CUT OF STORE KEY.

THE

ROCHESTER DIRECTORY

CONTAINING A

GENERAL DIRECTORY OF THE CITIZENS,

A

BUSINESS DIRECTORY,

AND THE

CITY AND COUNTY REGISTER.



N^o. XXVII.

FOR THE YEAR COMMENCING JULY 1, 1876.

ROCHESTER:

DREW, ALLIS & CO., No. 114 POWERS' BUILDINGS.

1876.

PRICE, \$3.

Entered according to act of Congress, in the year 1876, by

DREW, ALLIS & CO.,

in the office of the Librarian of Congress, at Washington.

CONTENTS.

	Page.		Page.
ABBREVIATIONS.....	33	LIBRARIES.....	392
ADVERTISING DEPARTMENT.....	follows 500	MANUFACTURING COMPANIES.....	411
ADVERTISING INDEX.....	7	MASONIC SOCIETIES.....	445
ALDERMEN.....	418	METEOROLOGICAL RECORD.....	32
ASSEMBLY DISTRICTS.....	486	MILITARY.....	490
ASSESSORS.....	420	MONROE COUNTY INSANE ASYLUM.....	482
ASSOCIATIONS.....	437	MONROE COUNTY PENITENTIARY.....	482
ATHENÆUM.....	440	MONROE COUNTY POOR HOUSE.....	482
AUCTIONEERS.....	363	MONROE COUNTY REGISTER.....	481
BANDS.....	396	MORTALITY STATISTICS.....	8, 9
BANKS.....	436, 494	MOUNT HOPE CEMETERY.....	423
BLOCKS, BUILDINGS, &c.....	21	NEWSPAPERS.....	396
BOARD OF FIRE UNDERWRITERS.....	422	NEW YORK STATE GOVERNMENT.....	485
BUSINESS DIRECTORY.....	361	NOTARIES PUBLIC.....	486
CALENDAR.....	6	NUISANCES.....	450
CANALS.....	486	NURSES.....	397
CEMETERIES.....	423	ODD FELLOWS.....	445
CENSUS.....	8, 9, 10, 11, 13, 14, 15, 16	OMNIBUSES.....	436
CHURCHES IN ROCHESTER.....	424	PENAL ORDINANCES.....	450
CHURCHES IN THE UNITED STATES.....	14	PENITENTIARY.....	482
CIRCUIT COURTS.....	482	PHYSICIANS.....	400
CITIZENS' GAS CO.....	493	POLICE DEPARTMENT.....	420
CITY GOVERNMENT.....	418	POOR HOUSE.....	482
CITY HOSPITAL.....	423	POPULATION OF CONNECTICUT.....	20
CITY ORDINANCES.....	450	POPULATION OF MASSACHUSETTS.....	15
CLERGYMEN.....	424	POPULATION OF NEW YORK.....	16
COMMISSIONERS OF DEEDS.....	488	POPULATION OF RHODE ISLAND.....	19
COMMISSIONERS OF EXCISE.....	419	POPULATION OF ROCHESTER.....	10
COMMON COUNCIL.....	418	POPULATION OF THE UNITED STATES.....	19
CONSTABLES.....	420	POPULATION OF TOWNS AND CITIES.....	11
CONTRACTORS.....	374	POST OFFICE.....	447
CORONERS.....	481	POST OFFICES IN MONROE COUNTY.....	449
COUNTY OFFICERS.....	481	PUBLIC CHARITABLE INSTITUTIONS.....	423
COURTS.....	482	PUBLIC SCHOOLS.....	426
CUSTOM HOUSE.....	485	RAILROADS.....	435
DISTRICT COURT OF THE UNITED STATES.....	484	RATES OF POSTAGE.....	448
EXECUTIVE BOARD.....	421	READING ROOMS.....	404
EXPRESSES.....	379	ROCHESTER CITY HOSPITAL.....	423
FIRE DEPARTMENT.....	421	ROCHESTER GAS LIGHT COMPANY.....	492
FIRE ORDINANCES.....	454, 458	ROCHESTER THEOLOGICAL SEMINARY.....	428
FIRE UNDERWRITERS.....	422	SAFE DEPOSIT COMPANY.....	499
GAS LIGHT COMPANIES.....	492	SAVINGS BANKS.....	496
GOOD TEMPLARS.....	446	SCHOOLS.....	407, 426
GRAND ARMY REPUBLIC.....	438	SEXTONS.....	424
HACK FARES.....	456	SHERIFF AND DEPUTIES.....	481
HALLS.....	21	SOCIETIES.....	437
HEALTH DEPARTMENT.....	422	STAGES.....	436
HOLIDAYS.....	436	STATE OFFICERS.....	485
HOLY SEPULCHRE CEMETERY.....	423	STATISTICS.....	7, 8, 9, 10
HORSE CARS.....	436	STOCK COMPANIES.....	411
HOSPITAL.....	423	STREET CARS.....	436
HOTELS.....	388	STREET DIRECTORY.....	22
HOUSE FOR IDLE AND TRUANT CHILDREN.....	423	SUNDAY SCHOOL SUPERINTENDENTS.....	424
INCORPORATED COMPANIES.....	411	SUPERVISORS.....	481
INDEX TO OUT-OF-TOWN ADVERTISERS.....	7	SUPREME COURT.....	482
INDUSTRIAL SCHOOL.....	438	SURROGATE'S COURT.....	483
INSANE ASYLUM.....	482	TAX LEVY.....	7
INSPECTORS OF ELECTION.....	420	TEACHERS.....	407, 413, 426
INSURANCE AGENTS.....	361	TELEGRAPH OFFICES.....	414
INSURANCE COMPANIES.....	389	TEMPERANCE SOCIETIES.....	446
INTERNAL REVENUE.....	485	UNITED STATES COURTS.....	484
JAIL.....	482	UNITED STATES GOVERNMENT.....	484
JUSTICES OF THE PEACE.....	422	UNITED STATES INTERNAL REVENUE.....	485
KNIGHTS OF PYTHIAS.....	446	UNIVERSITY OF ROCHESTER.....	428
LAMPS.....	423	WATER WORKS COMMISSION.....	419
LAWYERS.....	390	WESTERN HOUSE OF REFUGE.....	423
LEGISLATIVE DEPARTMENT.....	484, 485	YOUNG MEN'S CHRISTIAN ASSOCIATION.....	442

CHANGES IN THE ROCHESTER DIRECTORY.

Names in Directory of 1875.....	30,013
Names erased in preparing Directory of 1876.....	5,161
Names added in preparing Directory of 1876.....	24,852
Names in Directory of 1876 (including 1,249 deaths and removals not heretofore given).....	7,102
Increase from 1875 to 1876.....	31,654
	1,941

CALENDAR, 1876-7.

1876. JULY.							NOVEMBER.							MARCH.						
Su.	Mo.	Tu.	W.	Th.	Fr.	Sa.	Su.	Mo.	Tu.	W.	Th.	Fr.	Sa.	Su.	Mo.	Tu.	W.	Th.	Fr.	Sa.
..	1	1	2	3	4	1	2	3
2	3	4	5	6	7	8	5	6	7	8	9	10	11	4	5	6	7	8	9	10
9	10	11	12	13	14	15	12	13	14	15	16	17	18	11	12	13	14	15	16	17
16	17	18	19	20	21	22	19	20	21	22	23	24	25	18	19	20	21	22	23	24
23	24	25	26	27	28	29	26	27	28	29	30	25	26	27	28	29	30	31
30	31
AUGUST.							DECEMBER.							APRIL.						
Su.	Mo.	Tu.	W.	Th.	Fr.	Sa.	Su.	Mo.	Tu.	W.	Th.	Fr.	Sa.	Su.	Mo.	Tu.	W.	Th.	Fr.	Sa.
..	..	1	2	3	4	5	1	2	1	2	3	4	5	6	7
6	7	8	9	10	11	12	3	4	5	6	7	8	9	8	9	10	11	12	13	14
13	14	15	16	17	18	19	10	11	12	13	14	15	16	15	16	17	18	19	20	21
20	21	22	23	24	25	26	17	18	19	20	21	22	23	22	23	24	25	26	27	28
27	28	29	30	31	24	25	26	27	28	29	30	29	30
..	31
SEPTEMBER.							1877. JAN.							MAY.						
Su.	Mo.	Tu.	W.	Th.	Fr.	Sa.	Su.	Mo.	Tu.	W.	Th.	Fr.	Sa.	Su.	Mo.	Tu.	W.	Th.	Fr.	Sa.
..	1	2	..	1	2	3	4	5	6	1	2	3	4	5
3	4	5	6	7	8	9	7	8	9	10	11	12	13	6	7	8	9	10	11	12
10	11	12	13	14	15	16	14	15	16	17	18	19	20	13	14	15	16	17	18	19
17	18	19	20	21	22	23	21	22	23	24	25	26	27	20	21	22	23	24	25	26
24	25	26	27	28	29	30	28	29	30	31	27	28	29	30	31
..
OCTOBER.							FEB.							JUNE.						
Su.	Mo.	Tu.	W.	Th.	Fr.	Sa.	Su.	Mo.	Tu.	W.	Th.	Fr.	Sa.	Su.	Mo.	Tu.	W.	Th.	Fr.	Sa.
1	2	3	4	5	6	7	1	2	3	1	2
8	9	10	11	12	13	14	4	5	6	7	8	9	10	3	4	5	6	7	8	9
15	16	17	18	19	20	21	11	12	13	14	15	16	17	10	11	12	13	14	15	16
22	23	24	25	26	27	28	18	19	20	21	22	23	24	17	18	19	20	21	22	23
29	30	31	25	26	27	28	24	25	26	27	28	29	30
..

J. B. SWEETING & BRO.,

JOBBERS, IMPORTERS AND RETAILERS OF

MILLINERY AND FANCY GOODS,

84 STATE STREET, ROCHESTER, N. Y.

The Largest and Best Selected Stock, at the **LOWEST NEW YORK PRICES**, constantly on hand.

THE WEALTH OF ROCHESTER.

The Assessors' Valuation of Rochester:

	1874.	1875.	1876.
Real Estate	\$13,352,600	\$59,121,800	\$53,686,475
Personal Estate	905,000	2,229,900	1,978,495
Total	\$14,257,600	\$61,351,700	55,664,970
Amount of City Taxes	762,614.17	804,960.50	1,010,660.75
*Rate of City Tax, per \$1,000.....	53.49	13.31	18.75
Amount of County and State tax	323,243.53	352,719.06	10.00
Rate of County and State Tax per \$1,000.....	20.68	5.75	

Previous to 1875, the assessors valuation was about one-fifth of cash value. For 1875 the valuation is intended to represent FULL cash value of property, both real and personal.

*Rate of Taxes for 1876, per \$1,000, in Wards 1-14, \$18.75; in Wards 15 and 16, \$10.00; in wards 15 and 16 for lighted streets the rate is \$11.49—for streets lighted and having water, the rate is \$17.98.

THE CITY DEBT.

THE CITY DEBT JUNE 15th, 1876, CONSISTS OF THE FOLLOWING LOANS:

Genesee Valley railroad loan	\$172,000 00	Steam fire engines	20,000 00
Roch. and State Line railroad	600,000 00	Relief of soldiers' families.....	60,000 00
Rochester, Nunda and Penn R. R.,	150,000 00	Monroe avenue cemetery	5,000 00
Arsenal	18,686 00	Monroe avenue school.....	15,000 00
Floating debt.....	270,000 00	City Hall commissioners.....	335,000 00
Deep Hollow	20,000 00	Free Academy site and building.....	140,000 00
Main street bridge	20,000 00	Deficiency, unpaid taxes.....	50,000 00
Andrews street bridge.....	18,000 00	Water Works.....	3,182,000 00
Court and Main street bridge	32,000 00	Funding Loan, 1875.....	410,000 00
Clarissa street bridge.....	15,000 00	Central School, No. 5.....	20,000 00
Andrews street improvement.....	17,000 00		
Main street widening.....	25,000 00	Total	\$5,594,686 00

TAX LEVY.

Lighting the city.....	\$75,000 00	Laying water pipe by Executive Board....	75,000 00
Support of the Police Department.....	65,000 00	City Property Fund.....	5,000 00
General Contingent Expenses.....	30,000 00	Maintenance of Public Parks.....	2,000 00
Support and Relief of the Poor.....	45,000 00	Payment of 20 bonds, due Jan. 1, 1876, issued for Main street bridge.....	20,000 00
Support of Board of Health.....	20,000 00	Payment of 20 bonds, due May 1, 1876, issued for Deep Hollow Improvement.....	20,000 00
Support of House of Truants.....	9,000 00	Payment of 3 bonds due April 15, 1876, issued for Floating Debt.....	3,000 00
Support of Common Schools, viz:		Local Assessments on city property.....	1,000 00
To lease, alter and improve school houses	\$5,000	Payment of notes given for deficiencies in funds for 1875	45,000 00
For the purchase and improvement of sites, and to build and enlarge school houses.....	15,000	Interest on Water Works loan	222,740 00
Wages of teachers and contingent expenses.....	108,286	Interest on all other bonded debt.....	152,787 00
	128,286 00	Total	\$1,010,660 75
Erroneous Assessments.....	1,847 75		
Executive Board.....	90,000 00		

OUT OF TOWN ADVERTISERS.

Agricultural Machinery.

Johnston Harvester Company, Brockport, N. Y. (See page 695)

Baking Powder.

Newman S. A., Fairport, N. Y. (See page 686)

Bark Mills.

Howard Iron Works, Buffalo, N. Y. (See page 696)

Boat Builders.

Doyle Joseph, Charlotte, N. Y. (See page 598)

Bolt Cutters.

Howard Iron Works, Buffalo, N. Y. (See page 696)

Book Binders' Machinery.

Howard Iron Works, Buffalo, N. Y.

Cream Tartar.

Newman S. A., Fairport, N. Y. (See page 585)

Elevators.

Howard Iron Works, Buffalo, N. Y. (See page 696)

Freight Elevators.

Howard Iron Works, Buffalo, N. Y. (See page 696)

Glass Stainers.

Booth, Riester & Co., Buffalo, N. Y. (See page 589)

Hotels.

Forest House. Ernest Franke (See page 696)

Lake Shore House. J. B. Siebel. Charlotte

Parker House. H. D. Parker & Co. Boston,

Mass.

Steam Boat House. C. O'Connor. Charlotte

United States Hotel. J. B. Siebel. Charlotte

Lubricating and Illuminating Oil.

Pease F. S., 65 Main Street, Buffalo, N. Y. (See page 584)

Moulding Machines.

Lee H. A., Worcester, Mass. (See page 586)

Paper Boxes.

Dennison & Co., Boston, Mass. (See page 689)

Railroads.

Northern Central Railroad (See page 435)

Saleratus Manufacturers.

DeLand H. A. & Co., Fairport, N. Y. (See page 584)

Soap Manufacturers.

Thompson H., Buffalo, N. Y. (See page 586)

Soda Manufacturers.

DeLand H. A. & Co., Fairport, N. Y. (See page 584)

Stained Glass.

Booth, Riester & Co., Buffalo, N. Y. (See page 586)

Steamboats.

Norseman. R. Crawford (See page 430)

Tags.

Dennison & Co., Boston, Mass. (See page 589)

Wood Working Machinery.

Lee H. A., Worcester, Mass. (See page 586)

Yacht Builders.

Doyle Joseph, Charlotte, N. Y. (See page 598)

For City Advertisers, see reference against name.

MORTALITY IN ROCHESTER

for the year ending March 31st, 1876.

	April '75	May	June	July	August	Sept.	October	Nov.	Dec.	January	Feb.	March '76	Total
Total	196	144	159	190	190	211	133	132	142	147	138	164	1,946
Sex.													
Males.....	115	80	74	104	92	108	70	72	61	60	70	86	892
Females.....	81	63	85	83	97	101	62	60	80	86	68	78	1,044
Sex not given.....	0	1	0	3	1	2	1	0	1	1	0	0	10
Color.													
Males, white.....	115	78	74	104	92	107	70	69	61	59	70	85	948
Females, ".....	79	63	85	83	97	101	62	57	79	85	66	76	933
Males, colored.....	0	2	0	0	0	1	0	3	0	1	0	1	8
Females ".....	2	0	0	0	0	0	0	3	1	1	2	2	11
Unknown.....	0	1	0	3	1	2	1	0	1	1	0	0	10
Condition.													
Males, married.....	34	18	20	15	21	19	19	19	15	16	15	27	238
Males, single.....	60	50	49	85	64	84	47	47	38	40	54	57	675
Females, married.....	22	19	18	10	15	17	15	12	12	18	11	17	186
Females, single.....	59	88	62	71	72	68	44	40	57	54	51	52	668
Widowers.....	9	7	5	3	7	5	4	6	8	3	1	2	60
Widows.....	10	10	5	2	10	16	3	8	11	14	6	9	104
Unknown.....	2	2	0	4	1	2	1	0	1	2	0	0	15
Nativity.													
American.....	61	100	115	151	142	166	95	100	100	116	109	129	1,384
German.....	77	22	22	18	22	22	16	16	16	14	14	15	274
Irish.....	42	11	15	10	15	14	10	7	16	10	9	13	172
English.....	5	3	1	2	4	4	7	4	3	1	2	5	41
French.....	0	1	1	0	1	0	0	0	0	0	1	0	4
Canadian.....	8	6	5	3	1	2	1	4	5	3	2	1	41
Holland.....	1	0	0	0	0	0	0	0	0	0	0	0	1
Swiss.....	2	0	0	1	1	2	1	1	2	1	0	1	12
Scotch.....	0	0	0	1	1	1	1	0	0	0	0	0	4
Welch.....	0	0	0	1	0	0	0	0	0	0	0	0	1
Pole.....	0	0	0	0	1	0	1	0	0	1	0	0	3
Nova Scotian and Chinese.....	0	0	0	0	0	0	1	0	0	1	0	0	2
Unknown.....	0	1	0	3	1	0	0	0	0	1	0	0	6
Danish.....	0	0	0	0	0	0	0	0	0	0	1	0	1
Parentage.													
United States.....	71	46	45	56	57	70	42	51	42	50	43	70	643
Foreign.....	120	96	114	134	133	141	91	81	100	97	95	94	1,296
Unknown.....	5	2	0	0	0	0	0	0	0	0	0	0	7
Ages.													
Stillborn and Premature.....	8	8	8	7	8	8	11	9	12	11	14	13	117
Under 1 year.....	43	22	16	79	62	65	26	18	21	13	29	29	423
Between 1 year and 5.....	36	31	31	38	40	35	36	26	37	34	28	32	404
Between 5 and 10.....	19	13	23	16	6	19	6	11	7	19	9	15	163
Between 10 and 20.....	10	9	12	6	9	8	5	9	6	14	8	13	107
Between 20 and 30.....	14	11	17	10	13	16	10	15	12	11	15	10	154
Between 30 and 40.....	15	7	11	12	5	7	10	10	6	8	6	10	107
Between 40 and 50.....	11	6	7	4	10	4	7	6	7	9	6	6	83
Between 50 and 60.....	10	10	8	2	11	13	4	6	13	13	5	11	106
Between 60 and 70.....	6	10	9	7	11	16	8	10	7	7	5	12	108
Between 70 and 80.....	12	10	13	5	8	12	9	9	8	6	5	11	108
Between 80 and 90.....	8	3	3	2	4	6	1	3	3	1	5	2	41
Between 90 and 100.....	1	0	1	0	0	0	0	1	2	1	0	0	6
Unknown.....	3	4	0	2	3	2	1	0	1	0	3	0	19

FAMILIES AND DWELLINGS IN ROCHESTER.

U. S. Census of 1870.

WARD	Population.	FAMILIES.		DWELLINGS.	
		NUMBER.	PERSONS TO A FAMILY.	NUMBER.	PERSONS TO A DWELLING.
WARD 1.....	2,314	442	5.24	419	5.52
" 2.....	3,680	622	5.92	583	6.31
" 3.....	4,954	974	5.09	990	5.00
" 4.....	3,487	699	4.99	639	5.46
" 5.....	5,718	1,035	5.52	980	5.83
" 6.....	4,044	823	4.91	753	5.37
" 7.....	3,446	720	4.79	735	4.69
" 8.....	6,757	1,232	5.48	1,260	5.36
" 9.....	5,941	1,088	5.46	1,105	5.38
" 10.....	3,310	649	5.10	610	5.43
" 11.....	5,247	1,046	5.02	977	5.37
" 12.....	4,451	969	4.59	886	5.02
" 13.....	5,046	1,031	4.89	903	5.59
" 14.....	3,991	883	4.52	809	4.93
TOTAL AND AVERAGE....	62,886	12,213	4.11	11,649	5.36

MORTALITY—NATIVITY.

TABLE OF MORTALITY IN ROCHESTER

	April	May	June	July	Aug.	Sept.	Oct.	Nov.	Dec.	Jan.	Feb.	Mar.	Total
1860-61.....	86	78	66	81	105	94	65	73	65	76	64	89	914
1861-62.....	72	77	80	80	106	100	82	86	82	74	72	89	1,000
1862-63.....	85	111	105	100	160	135	95	85	105	91	71	110	1,253
1863-64.....	84	91	62	78	155	120	87	85	103	78	83	93	1,119
1864-65.....	98	108	93	94	204	238	124	80	61	68	73	93	1,334
1865-66.....	69	77	79	92	119	138	124	78	69	63	66	70	1,034
1866-67.....	70	72	49	87	79	83	74	83	57	46	54	89	843
1867-68.....	84	47	82	81	112	97	112	77	91	89	94	96	1,112
1868-69.....	70	69	65	100	119	7	95	56	83	75	64	85	958
1869-70.....	77	84	73	101	117	140	113	107	76	75	64	85	1,112
1870-71.....	84	94	93	119	125	113	100	87	82	98	89	107	1,191
1871-72.....	86	87	69	123	132	90	89	68	75	105	111	153	1,188
1872-73.....	156	109	99	173	197	175	117	114	110	122	110	150	1,633
1873-74.....	117	117	104	152	158	140	114	85	117	104	87	110	1,400
1874-75.....	97	100	80	99	175	146	123	97	122	172	153	176	1,540

NATIVITY OF THE INHABITANTS OF ROCHESTER.

The following table shows the birthplace of the inhabitants of Rochester according to the United States census of 1870.

United States.	Not stated.....	37	Not specified.....	408		
	Total U. S.....	41,202	Total Germany	7,730		
	FOREIGN COUNTRIES.		G. BRITAIN AND IRELAND			
Alabama.....	3	Asia.....	4	England.....	2,530	
Arkansas.....	5	Australia.....	1	Ireland.....	6,078	
California.....	10	Austria.....	39	Scotland.....	428	
Connecticut.....	590	Belgium.....	4	Wales.....	31	
Delaware.....	13	Bohemia.....	7	Not specified.....	4	
Florida.....	1	<i>British America.</i>				
Georgia.....	4	Canada.....	2,604	Total G. B. and		
Illinois.....	65	New Brunswick...	15	Ireland.....	9,071	
Indiana.....	47	Newfoundland...	12	Holland.....	510	
Iowa.....	16	Nova Scotia.....	26	Hungary.....	7	
Kansas.....	5	Total Brit. Am.	2,658	India.....	2	
Kentucky.....	20	China.....	1	Italy.....	16	
Louisiana.....	25	Denmark.....	7	Luxemburg.....	29	
Maine.....	102	France.....	475	Norway.....	15	
Maryland.....	99	<i>Germany.</i>			Pacific Islands...	1
Massachusetts....	673	Baden.....	1,585	Poland.....	71	
Michigan.....	145	Bavaria.....	1,691	Portugal.....	2	
Minnesota.....	4	Brunswick.....	1	Russia.....	36	
Mississippi.....	4	Hamburg.....	26	South America...	2	
Missouri.....	20	Hanover.....	89	Spain.....	3	
New Hampshire...	186	Hessen.....	733	Sweden.....	20	
New Jersey.....	193	Lübeck.....	2	Switzerland.....	440	
New York.....	37,734	Mecklenburg.....	384	Turkey.....	1	
North Carolina...	13	Nassau.....	34	West Indies.....	9	
Ohio.....	191	Oldenburg.....	3	At sea.....	22	
Pennsylvania.....	363	Prussia.....	1,829	Not stated.....	5	
Rhode Island.....	73	Saxony.....	131	Total foreign...	21,184	
South Carolina...	6	Weimar.....	4	Total native....	41,202	
Tennessee.....	8	Württemberg.....	810	Aggregate pop.	62,386	
Texas.....	4					
Vermont.....	404					
Virginia & W. Va...	63					
Wisconsin.....	63					
Dist. of Columbia	25					
At sea in U.S. service	2					

Central Library of Rochester and Monroe County - City Directory Collection - 1876

POPULATION OF ROCHESTER.

WARDS.	1835.	1840.	1845.	1850.	1855.	1860.	1865.	1870.	Native.	Foreign.	White.	Colored.
WARD 1.....	2272	2816	3002	3053	2225	2474	2220	2314	1565	749	2285	29
“ 2.....	3314	4685	2768	3630	3656	3736	3468	3680	2401	1279	3680
“ 3.....	2892	4203	3730	4491	4386	4779	4820	4954	3651	1303	4860	94
“ 4.....	3013	3832	2828	3511	3323	3180	3236	3487	2592	895	3469	18
“ 5.....	2913	4655	4121	3705	4376	4594	4616	5718	3661	2057	5706	12
“ 6.....	3984	7061	5391	6054	3613	4044	2561	1483	4039	5
“ 7.....	1861	3336	4619	2274	2605	3446	2734	912	3396	50
“ 8.....	1975	2920	3951	4440	4480	6757	4445	2312	6644	113
“ 9.....	2696	4696	7218	4601	5084	5941	4060	1881	5926	15
“ 10.....	4732	5498	2732	3310	2237	1073	3278	32
“ 11.....	3684	4300	5247	3158	2089	5247
“ 12.....	2890	3245	4451	2933	1518	4414	37
“ 13.....	3228	5046	2765	2281	5042	4
“ 14.....	3293	3991	2639	1352	3973	18
TOTAL.....	14404	20191	26965	36403	43877	48204	50940	62386	41202	21184	61959	427

ROCHESTER founded, 1812.

Incorporated a Town, 1817.

Incorporated a City, 1834.

EARLY POPULATION.

1815, - - - -	331	1825, - - - -	5273
1818, - - - -	1049	1826, - - - -	7669
1820, - - - -	502	1830, - - - -	1083
1822, - - - -	2700	1834, - - - -	12252

Wards 1 2, 3, 4, 5, erected 1834.
 Wards 6, 7, 8, 9, erected 1845.
 Ward 10, erected 1853.
 Ward 11, erected 1858.
 Ward 12, erected 1859.
 Wards 13 14, erected 1865.

LARGE CITIES OF THE WORLD.

The following Table gives the name, country and population of all cities of Europe containing 50,000 inhabitants, and of all in the world whose population is 100,000—except cities in the United States, given on page 11—besides other places of note, of less population; compiled from latest censuses and authorities:

Aberdeen, Scotland,	88,125	Grätz, Austria,	80,732	Odessa, Russia,	121,335
Adrianople, Turkey,	150,000	Hague, Netherlands,	92,785	Oldham, England,	82,629
Agra, East India,	125,000	Halifax, England,	65,510	Osporto, Portugal,	89,321
Ahmedabad, East India,	130,000	Halifax, Nova Scotia,	29,582	Osaka, Japan,	530,885
Aix-la-Chapelle, Prussia,	74,238	Hamburg, Germany,	338,974	Ottawa, Canada,	21,545
Aleppo, Turkey,	100,000	Hamilton, Canada,	26,716	Padua, Italy,	66,100
Alexandria, Egypt,	238,888	Hankow, China,	800,000	Palermo, Italy,	219,938
Altona, Holstein,	74,131	Hanover, Prussia,	87,641	Palma, Spain,	53,019
Amiens, France,	61,063	Havana, Cuba,	169,184	Panama, Colombia,	11,000
Amoy, China,	250,000	Havre, France,	86,828	Paris, France,	1,851,792
Amrister, East India,	130,000	Hong Kong, China,	124,198	Patna, East India,	284,132
Amsterdam, Netherlands,	281,805	Huddersfield, England,	70,253	Pekin, China,	1,648,814
Angers, France,	54,791	Hull, England,	121,892	Pesth, Hungary,	200,476
Antwerp, Belgium,	126,663	Hyderabad, East India,	200,000	Plymouth, England,	68,758
Athens, Greece,	48,107	Ipswich, England,	42,947	Port-au-Prince, Haiti,	22,000
Augsburg, Bavaria,	51,284	Jakoba, Africa,	150,000	Portsmouth, England,	113,569
Bangalore, East India,	140,000	Jongping, China,	200,000	Posen, Hungary,	56,374
Bangkok, Siam,	500,000	Jeddo, Japan,	1,554,848	Prague, Austria,	157,713
Barcelona, Spain,	252,015	Jerusalem, Palestine,	18,000	Preston, England,	85,427
Barmen, Prussia,	74,496	Joudpore, East India,	150,000	Quebec, Canada,	59,699
Baroda, East India,	140,000	Kasan, Russia,	78,602	Quito, Ecuador,	76,000
Basel, Switzerland,	44,834	Kharkoff, Russia,	59,968	Rheims, France,	71,994
Bath, England,	52,557	Kagosima, Japan,	180,000	Riga, Russia,	102,043
Belfast, Ireland,	174,394	Kicheneff, Russia,	103,998	Río de Janeiro, Brazil,	260,000
Benares, East India,	200,000	Kieff, Russia,	70,591	Rochedale, England,	44,559
Berditchew, Russia,	53,787	Kingston, Jamaica,	35,000	Rome, Italy,	244,484
Berlin, Prussia,	826,341	Kingston-upon-Hull, Eng.,	121,892	Rotterdam, Netherlands,	125,983
Bern, Switzerland,	36,001	Kjōng, Korea,	190,200	Roubaix, France,	75,980
Beyrout, Turkey,	70,000	Königsberg, Prussia,	112,123	Rouen, France,	102,470
Bhurtpore, Hindostan,	100,000	LaPuebla, Mexico,	70,603	Salford, England,	124,801
Birkenhead, England,	45,418	Lausanne, Switzerland,	26,520	Santiago, Chili,	150,000
Birmingham, England,	343,787	Leeds, England,	259,212	Santiago deCuba, Cuba,	45,000
Blackburn, England,	76,339	Leghorn, Italy,	118,851	Saragossa, Spain,	82,189
Bogota, New Granada,	46,000	Leicester, England,	95,220	Saratoff, Russia,	93,218
Bologna, Italy,	115,957	Leyden, Netherlands,	39,574	Sevilla, Spain,	115,000
Bolton, England,	82,853	Leipsig, Saxony,	106,925	Shanghai, China,	320,000
Bombay, East India,	646,636	Lemberg or Leopold, Austria,	87,105	Sheffield, England,	239,946
Bordeaux, France,	194,241	Lidge, Belgium,	106,442	Smyrna, Turkey,	150,000
Borfdorf, England,	145,880	Lille, France,	158,117	Sochow, China,	2,000,000
Bremen, Germany,	82,970	Lima, Peru,	121,370	Southampton, England,	53,741
Breslau, Prussia,	208,025	Limerick, Ireland,	49,670	St. Etienne, France,	96,620
Brest, France,	79,847	Limoges, France,	55,134	Stettin, Prussia,	76,149
Brighton, England,	90,011	Lisbon, Portugal,	275,286	St. John, New Brunswick,	28,988
Bristol, England,	182,552	Liverpool, England,	493,405	St. John's, New Foundland,	22,583
Brün, Austria,	73,464	London, Eng., { City	74,897	Stockholm, Sweden,	138,512
Brunswick, Germany,	57,883	London, Eng., { Metro. Dis. 3,	2,668,987	Stockport, England,	53,014
Brussels, Belgium,	314,077	London, Canada,	18,113	Stratford, England,	23,286
Bucharest, Turkey,	141,754	Lubek, Germany,	39,743	Stratford-on-Avon, Eng.,	7,342
Buenos Ayres, Argen. Rep.,	177,787	Lucknow, East India,	303,900	St. Petersburg, Russia,	667,926
Cadiz, Spain,	71,914	Lyons, France,	323,054	Strasbourg, France,	84,167
Cairo, Egypt,	256,700	Madras, East India,	427,771	Stuttgart, Würtemberg,	91,623
Calcutta, East India,	447,601	Madrid, Spain,	332,294	Sunderland, England,	98,242
Cambridge, England,	30,078	Magdeburg, Prussia,	84,452	Swansea, England,	51,702
Carthagena, Spain,	54,315	Malaga, Spain,	113,050	Sydney, New South Wales,	134,755
Canton, China,	1,300,000	Malta Island,	146,852	Szegedin, Hungary,	62,700
Catania, Italy,	84,397	Manchester, England,	351,189	Tabreez, Persia,	150,000
Cawnpore, East India,	111,221	Manilla, Philippine Islands,	160,000	Taschkend, Russia,	100,000
Chemnitz, Saxony,	68,229	Marseilles, France,	312,864	Tauris, Persia,	210,000
Christiania, Norway,	66,657	Matanzas, Cuba,	30,000	Tchang-tchan-fu, China,	1,000,000
Cologne, Prussia,	129,233	Melbourne, Australia,	191,254	Tientsin, China,	200,000
Constantinople, Turkey,	1,075,000	Merthyr Tydfil, Wales,	97,020	Tiflis, Russia,	60,937
Copenhagen, Denmark,	180,866	Messina, Italy,	111,854	Tokat, Turkey,	150,000
Cork, Ireland,	78,382	Metz, France,	54,817	Toronto, Canada,	46,092
Crefeld, Prussia,	57,128	Mexico, Mexico,	210,328	Toulon, France,	77,126
Cron-tadt, Russia,	45,155	Milan, Italy,	199,009	Toulouse, France,	126,936
Damascus, Turkey,	150,000	Montevideo, Uruguay,	105,296	Trieste, Austria,	104,707
Dantzic, Prussia,	89,122	Montpelier, France,	55,606	Tschungking, China,	200,000
Delhi, East India,	152,406	Montreal, Canada,	107,225	Tula, Russia,	58,150
Derby, England,	49,810	Moorshedabad, East India,	146,963	Tunis, Tunis,	150,000
Dover, England,	28,506	Morocco, Morocco,	50,000	Turin, Italy,	207,770
Dresden, Saxony,	177,089	Moscow, Russia,	611,970	Frumtsi, China,	150,000
Dublin, Ireland,	245,722	Mulhouse, France,	52,825	Utrecht, Netherlands,	59,970
Dundee, Scotland,	118,474	Munich, Bavaria,	170,698	Valencia, Spain,	145,512
Dusseldorf, Prussia,	69,351	Munca, Spain,	109,446	Valladolid, Spain,	50,017
Edinburgh, Scotland,	196,500	Nagpore, East India,	111,231	Valparaiso, Chili,	70,438
Elberfeld, Prussia,	73,394	Nancy, France,	52,978	Venice, Italy,	128,901
Exeter, England,	34,650	Nantes, France,	118,517	Vera Cruz, Mexico,	12,200
Florence, Italy,	167,093	Naples, Italy,	428,443	Verona, Italy,	59,169
Foochow, China,	600,000	Newcastle-upon-Tyne, Eng.	128,143	Vienna, Austria,	578,525
Frankfort-on-Maine, Prus.,	90,922	Nice, France,	62,372	Vilna, Russia,	79,265
Geneva, Switzerland,	46,783	Nicolaeff, Russia,	57,977	Warsaw, Russia,	251,584
Genoa, Italy,	130,269	Nimes, France,	63,391	Wolverhampton, England,	68,291
Ghent, Belgium,	121,469	Ningpo, China,	500,000	Worcester, England,	33,226
Gibraltar,	25,216	Northampton, England,	41,168	Yorkland, China,	200,000
Glasgow, Scotland,	547,538	Norwich, England,	80,396	York, England,	43,796
Göteborg, Sweden,	59,329	Nottingham, England,	86,621	Yutschang, China,	200,000
Granada, Spain,	100,678	Nürnberg, Bavaria,	82,929	Zürich, Switzerland,	21,199

Central Library of Rochester and Monroe County - City Directory Collection - 1876

STATISTICS OF CHURCHES IN THE UNITED STATES. (U. S. CENSUS OF 1870.)

DENOMINATIONS.	Organ- iza't'ns.	Fdi- fices.	Sittings.	Property.	Ch'ch's in 1860.	* ORGANIZATIONS IN STATES AND TERRITORIES.
Baptist (regular).....	14,474	12,857	3,997,116	\$39,229,221	11,221	Ga. 1,364; Ky. 1004; N. C. 951; Tenn. 942; N. Y. 817; Va. 795; Mo. 792; Ala. 786; Ill. 677; Miss. 665; Ohio 555; Ind. 552; S. C. 518; Ark. 463; Penns. 395; Mich. 335; Io. 307; W. Va. 302; Tex. 275; Mass. 271; La. 237; N. J. 164; other States, 1055.
Baptist (other).....	1,355	1,105	363,019	2,378,977	929	Penns. 235; Maine 218; O. 158; N. Y. 85; N. H. 82; Ind. 68; Wis. 67; Vir. 54; Ill. 45; Io. 45; Tenn. 45; Md. 38; N. C. 34; R. I. 34; Mich. 31; W. Va. 23; Vt. 16; Mass. 15; Minn. 14; Mo. 13; Ark. 10; Conn. 5; Ga. 5; S. C. 5; N. J. 4; Ala. 3; Ore. 2; Kan. 1.
Christian.....	3,578	2,822	865,602	6,425,137	2,068	O. 681; Ken. 490; Ind. 455; Mo. 394; Ill. 350; Tenn. 203; Io. 113; Va. 100; Penn. 97; N. Y. 95; Ark. 90; N. C. 66; Me. 44; Mich. 38; W. Va. 36; Kan. 35; Ga. 34; Mass. 31; Cal. 30; Miss. 30; Ore. 26; Ala. 19; N. H. 19; Tex. 18; Vt. 14; Wis. 13; other States, 57.
Congregational.....	2,887	2,715	1,117,212	25,069,698	2,234	Mass. 50; Conn. 290; N. Y. 268; Me. 221; Ill. 212; O. 198; Io. 187; Vt. 133; N. H. 169; Wis. 157; Mich. 156; Minn. 57; Kan. 43; Cal. 40; Penn. 40; Mo. 37; R. I. 27; Ind. 18; N. J. 14; Ga. 10; Neb. 10; La. 9; Ore. 8; Ala. 4; Col. 4; Tenn. 3; D. C. 2; other States, 10.
Episcopal (Protestant).....	2,835	2,601	991,051	36,514,549	2,145	N. Y. 175; Penn. 238; Va. 185; Md. 153; Conn. 139; N. J. 128; O. 114; Mass. 107; Ill. 105; Mich. 100; Mo. 85; S. C. 82; Wis. 82; N. C. 77; Minn. 64; Io. 58; Ala. 50; Ind. 49; Cal. 45; R. I. 42; Ky. 38; La. 36; Ga. 35; Miss. 33; Tenn. 33; Vt. 33; other States, 293.
Evangelical Association.....	815	641	193,796	2,301,650	Penn. 256; Wis. 179; O. 157; Ill. 58; Ind. 47; I. 32; N. Y. 25; Minn. 20; Mich. 15; Ken. 5; Mo. 5; Neb. 5; Md. 3; Kan. 2; Ore. 2; W. Va. 2; Cal. 1; D. C. 1.
Friends.....	692	662	224,664	3,939,560	726	Penn. 114; O. 91; N. Y. 89; Io. 82; Ind. 81; N. J. 63; Mass. 29; N. C. 28; Md. 22; R. I. 17; N. H. 13; Va. 12; Mich. 10; Del. 8; Kan. 7; Ill. 5; Tenn. 5; Vt. 5; Cal. 5; Conn. 2; D. C. 2; Mo. 2; Wis. 2; S. C. 1.
Jewish.....	189	152	73,265	5,155,234	77	N. Y. 47; Me. 32; Penn. 13; Ill. 10; Va. 8; Cal. 7; Ga. 5; O. 5; Conn. 5; Ind. 5; Io. 5; La. 5; Md. 5; Tex. 5; other States, 10.
Lutheran.....	3,082	2,776	977,332	14,917,747	2,128	Tenn. 4; Wis. 4; Ky. 3; S. C. 3; Ala. 2; D. C. 2; Kan. 2; Ark. 2; Cal. 1; N. J. 1; N. C. 1; R. I. 1; W. Va. 1.
Methodist.....	25,278	21,337	6,528,209	69,854,121	19,883	Penn. 904; O. 477; Ill. 230; Ind. 195; N. Y. 190; Wis. 171; Minn. 135; Mich. 96; Mo. 94; Md. 88; Va. 80; Io. 79; N. C. 73; S. C. 49; Tex. 23; Tenn. 22; W. Va. 22; N. J. 19; Neb. 14; Ga. 11; D. C. 10; Miss. 10; Kan. 9; Ken. 7; Cal. 6; Conn. 4; Dak. 3; other States, 11.
Miscellaneous.....	27	17	6,935	135,650	2	O. 2,161; N. Y. 1,745; Ill. 1,426; Ind. 1,403; Tenn. 1,339; Penn. 1,286; Ga. 1,248; N. C. 1,193; Mo. 1,066; Va. 1,011; Io. 982; Ky. 978; W. Va. 879; Mich. 864; Miss. 787; Md. 771; S. C. 611; Ark. 583; N. J. 513; Wis. 508; Tex. 355; Me. 327; Mass. 297; other States, 2446.
Moravian (Unitas Fratrum).....	72	67	25,700	709,100	49	Cal. 9; Penn. 7; N. Y. 4; Conn. 3; Mass. 2; Ill. 1; S. C. 1.
Mormon.....	189	171	87,838	656,750	24	Penn. 15; Wis. 13; N. C. 10; Minn. 6; N. Y. 6; Io. 5; Ill. 4; N. J. 4; O. 4; Ind. 2; Md. 1; Mich. 1; Va. 1.
New Jerusalem (Swedenb'n).....	90	61	18,755	869,700	58	Utah 160; Io. 6; Ill. 5; Cal. 4; Mass. 4; Id. 2; Mo. 2; Flor. 1; Kan. 1; Me. 1; Neb. 1; Nev. 1; Wis. 1.
Presbyterian.....	6,262	5,683	2,198,900	47,828,732	5,061	Mass. 15; Ill. 13; Penn. 11; O. 8; N. J. 6; Wis. 5; Mo. 4; N. Y. 4; Me. 3; Md. 3; Mich. 3; R. I. 3; Va. 3; Cal. 1; Conn. 1; Del. 1; D. C. 1; Ga. 1; Ind. 1; La. 1; Minn. 1; N. H. 1.
Presbyterian (other).....	1,562	1,388	499,344	5,436,524	1,345	Penn. 739; N. Y. 672; O. 628; Ind. 333; Mo. 332; Ky. 289; Io. 270; Tenn. 262; N. J. 250; Va. 24; N. C. 185; Miss. 181; Mich. 177; S. C. 148; Ala. 145; Ga. 121; Ark. 106; Wis. 96; W. Va. 87; Tex. 86; Kan. 84; Cal. 79; Md. 77; Minn. 75; other States, 197.
Ref. Ch. in Am. (late Dut' h Ref).....	471	468	227,228	10,359,255	440	Tenn. 284; Penn. 288; O. 164; Ill. 156; Mo. 144; Io. 105; Miss. 81; Ala. 57; Ark. 65; N. Y. 54; Ind. 42; N. C. 19; Ky. 17; S. C. 16; Tex. 15; Ga. 13; Ore. 12; Kan. 10; Mich. 10; Vt. 2; W. Va. 2; Wis. 2; Minn. 1; N. J. 1; R. I. 1.
Ref. Ch. in U.S. (late Ger. Ref).....	1,256	1,145	431,700	5,775,215	676	N. Y. 304; N. J. 97; Mich. 28; Ill. 14; Penn. 10; Wis. 5; Io. 4; Ind. 2; Minn. 2; O. 2; S. C. 2; Conn. 1; Md. 1; Va. 1.
Roman Catholic.....	4,127	3,806	1,990,514	60,985,566	2,550	Penn. 712; O. 288; Md. 47; Ind. 34; Ill. 32; N. C. 31; Va. 24; Mich. 19; Wis. 18; Io. 13; Mo. 11; N. Y. 9; N. J. 6; Mass. 3; La. 2; Me. 2; W. Va. 2; Dak. 1; D. C. 1; Kan. 1.
Second Advent.....	225	140	34,555	306,240	70	N. Y. 455; Penn. 362; Wis. 329; O. 295; Ill. 290; Io. 216; Ind. 204; Mass. 196; Mo. 184; Mich. 167; Cal. 160; Minn. 154; N. Mex. 153; Ky. 130; N. J. 107; La. 103; Md. 103; Conn. 144; Vt. 40; W. Va. 40; Kan. 37; Tex. 36; Me. 32; Miss. 27; R. I. 22; other States, 242.
Shaker.....	18	18	8,850	86,900	12	Mich. 39; Io. 28; Me. 28; N. H. 21; N. Y. 17; R. I. 17; Mass. 15; Vt. 15; Wis. 10; Ill. 8; Conn. 7; Cal. 3; Penn. 3; W. Va. 3; Flor. 1; Mo. 1; O. 1; Wash. 1.
Spiritualist.....	95	22	6,970	100,150	17	Mass. 4; O. 4; N. Y. 3; Ky. 2; N. H. 2; Me. 2; Conn. 1.
Unitarian.....	331	310	155,471	6,282,675	264	Mich. 35; Mass. 19; Ill. 7; Cal. 6; Minn. 5; O. 4; Me. 3; N. Y. 3; Conn. 2; Mo. 2; N. J. 2; Ore. 2; Wis. 2; N. H. 1; R. I. 1; Vt. 1.
United Brethren in Christ.....	1,445	937	265,025	1,819,810	Mass. 180; Ill. 23; N. H. 23; N. Y. 22; Me. 18; Mo. 10; O. 8; Mich. 7; Wis. 7; Penn. 4; R. I. 4; Vt. 4; Io. 3; Neb. 3; Cal. 2; Kan. 2; Ore. 2; Conn. 2; Del. 1; D. C. 1; Ind. 1; Ky. 1; La. 1; Md. 1; N. J. 1; S. C. 1.
Universalist.....	719	602	210,894	5,692,325	664	O. 370; Penn. 201; Io. 188; Ind. 184; Ill. 125; W. Va. 94; Mich. 69; Va. 42; Mo. 38; Md. 36; Wis. 34; Kan. 24; Ore. 10; N. Y. 7; Tenn. 7; Minn. 5; Neb. 4; Cal. 3; Wash. 3; Mass. 1.
Unknown (union).....	409	552	153,202	965,295	1,366	N. Y. 124; Mass. 97; Me. 84; O. 75; Vt. 60; Ill. 52; Io. 35; Mich. 33; N. H. 24; Penn. 21; Ind. 18; Minn. 18; Conn. 14; Wis. 12; Ala. 6; Mo. 5; Ga. 5; N. J. 4; R. I. 4; W. Va. 4; Neb. 3; S. C. 3; Ky. 2; Md. 2; N. C. 2; Ark. 1; Cal. 1; Del. 1; D. C. 1; Kan. 1; Miss. 1; Ore. 1.
Unknown (local missions).....	26	27	11,925	687,800	N. Y. 93; Mass. 42; Va. 42; Ark. 3; O. 33; Me. 26; Penn. 26; Vt. 24; Ala. 13; Miss. 12; N. H. 12; W. Va. 11; Ill. 10; Ga. 6; Mo. 5; Ind. 4; Md. 4; Ky. 3; Mich. 3; N. J. 2; N. C. 2; Ore. 1; Tex. 1; Wis. 1.
Total Churches in U. S.	72,459	63,082	21,665,062	\$354,483,581	54,009	N. Y. 14; Ind. 4; O. 2; Ill. 1; N. H. 1; R. I. 1; N. C. 1; Va. 1; Wis. 1.

POPULATION OF MASSACHUSETTS.

New Braintree.....	606	Phillipston.....	665	Sterling.....	1,569	Westborough.....	6,251
Northborough.....	1,393	Princeton.....	1,063	Sturbridge.....	2,213	West Boylston.....	2,903
Northbridge.....	4,030	Royalston.....	1,260	Sutton.....	3,051	West Dookfield.....	1,900
North Brookfield.....	3,749	Rutland.....	1,030	Templeton.....	2,764	Westminster.....	1,717
Jakham.....	873	Shrewsbury.....	1,524	Upton.....	2,125	Winchendon.....	3,763
Oxford.....	2,938	Southborough.....	1,986	Uxbridge.....	3,029	*Worcester.....	49,317
Paxton.....	600	Southbridge.....	5,740	Warren.....	3,267		
Petersham.....	1,203	Spencer.....	3,451	Webster.....	5,004		210,295

POPULATION OF NEW YORK.

CENSUS OF 1875.

*Denotes cities.

Total.....4,705,208

Albany.		Carrollton.....	1,218	Ellery.....	1,717	Dannemora.....	1,294
*Albany.....	86,013	Cold Spring.....	924	Ellicott.....	9,026	Ellenburgh.....	3,186
Berne.....	2,567	Conewango.....	1,320	Ellington.....	1,589	Moers.....	4,543
Bethlehem.....	3,763	Dayton.....	1,402	French Creek.....	1,049	Peru.....	2,839
Coeymans.....	3,126	East Otto.....	1,185	Gerry.....	1,155	Pittsburgh.....	8,804
*Cohoes.....	17,516	Ellicottville.....	1,907	Hanover.....	4,155	Saranac.....	4,110
Guiderland.....	3,510	Farmersville.....	1,094	Harmony.....	3,622	Schuyler Falls.....	1,719
Knox.....	1,641	Franklinville.....	1,657	Kiantone.....	520	Asylums, Prisons, &c.....	21
New Scotland.....	3,268	Freedom.....	1,341	Min.....	1,195		
Rensselaerville.....	2,582	Great Valley.....	1,624	Poland.....	1,973		
Watervliet.....	20,734	Hinsdale.....	1,575	Pomfret.....	4,493	Columbia.	49,761
Westerlo.....	2,317	Humphrey.....	1,071	Portland.....	2,048	Ancram.....	1,715
Asylums, Prisons, &c.....	493	Ischua.....	910	Ripley.....	1,899	Austerlitz.....	1,388
	147,530	Leon.....	1,201	Sheridan.....	1,665	Canaan.....	1,702
Allegany.		Little Valley.....	1,147	Sherman.....	1,457	Chatham.....	4,501
Alfred.....	1,381	Lyndon.....	810	Stockton.....	1,835	Claverack.....	3,825
Allen.....	777	Machias.....	1,303	Villanova.....	1,438	Clermont.....	937
Alma.....	803	Mansfield.....	1,153	Westfield.....	3,679	Copake.....	1,884
Almond.....	1,612	Napoli.....	1,092	Part Catt. Ind. Res.....	6	Gallatin.....	1,361
Amity.....	2,021	New Albion.....	1,584	Asylums, Prisons, &c.....	42	Germantown.....	1,445
Andover.....	1,983	Olean.....	3,109			Ghent.....	2,963
Angelica.....	1,500	Otto.....	1,091	Chemung.	64,869	Greenport.....	1,354
Belfast.....	1,598	Perrysburgh.....	1,393	Ashland.....	1,080	Hillsdale.....	1,879
Birdsall.....	797	Persia.....	1,336	Baldwin.....	1,006	*Hudson.....	8,828
Bolivar.....	1,002	Portville.....	2,146	Big Flats.....	1,938	Kinderhook.....	4,060
Burns.....	1,613	Randolph.....	2,433	Calin.....	1,426	Livingston.....	1,960
Caneadea.....	1,732	Red House.....	453	Chemung.....	2,002	New Lebanon.....	2,459
Centerville.....	997	Salamanca.....	2,827	Elmira town.....	1,481	Stockport.....	1,648
Clarksville.....	797	South Valley.....	872	*Elmira.....	20,538	Stuyvesant.....	2,393
Cuba.....	2,260	Yorkshire.....	1,689	Erin.....	1,561	Taghkanick.....	1,401
Friendship.....	1,871	Indian Reservations.....	1,148	Horseheads.....	3,399	Asylums, Prisons, &c.....	53
Genesee.....	958	Asylums, Prisons, &c.....	25	Southport.....	3,285		
Granger.....	1,159		48,477	Van Etten.....	1,735	Cortland.	47,756
Grove.....	1,114	Cayuga.		Veteran.....	2,373	Cincinnati.....	1,079
Hume.....	1,932	*Auburn.....	18,359	Asylums, Prisons, &c.....	55	Cortlandville.....	6,140
Independence.....	1,217	Aurelius.....	1,982			Cuyler.....	1,253
New Hudson.....	1,148	Brutus.....	2,831	Chenango.	41,879	Freetown.....	866
Rushford.....	1,516	Cato.....	2,097	Afton.....	2,238	Harford.....	1,038
Scio.....	1,641	Conquest.....	1,728	Bainbridge.....	1,931	Homert.....	3,657
Ward.....	705	Fleming.....	1,262	Columbus.....	1,184	Lapeer.....	734
Wellsville.....	4,247	Genoa.....	2,419	Coventry.....	1,349	Marathon.....	1,518
West Almond.....	798	Ira.....	2,067	German.....	666	Preble.....	1,089
Willing.....	1,313	Ledyard.....	2,257	Greene.....	3,565	Scott.....	1,055
Wirt.....	1,204	Locke.....	1,131	Guilford.....	2,523	Solon.....	894
Asylums, Prisons, &c.....	25	Mentz.....	2,303	Lincklaen.....	855	Taylor.....	1,025
	41,721	Montezuma.....	1,398	Macdonough.....	1,277	Truxton.....	1,468
Broome.		Moravia.....	2,351	New Berlin.....	2,309	Virgil.....	1,859
Barker.....	1,441	Niles.....	1,877	North Norwich.....	1,027	Willett.....	863
Binghamton.....	2,434	Owasco.....	1,289	Norwich.....	5,935	Asylums, Prisons, &c.....	32
*Binghamton.....	15,550	Scipio.....	1,920	Orelie.....	1,567		
Chenango.....	1,630	Sempromius.....	1,123	Oxford.....	2,989	Delaware.	24,500
Colesville.....	3,327	Sennett.....	1,603	Pharsalia.....	1,106	Andes.....	2,711
Conklin.....	1,290	Springport.....	2,183	Pitcher.....	1,082	Bovina.....	983
Fenton.....	1,562	Sterling.....	3,046	Plymouth.....	1,348	Colchester.....	2,734
Kirkwood.....	1,379	Summer Hill.....	1,002	Preston.....	825	Davenport.....	2,195
Lisle.....	2,445	Throop.....	1,213	Sherburne.....	2,915	Delhi.....	2,945
Maine.....	2,071	Venice.....	1,757	Smithville.....	1,522	Franklin.....	3,002
Nanticoke.....	1,055	Victory.....	1,946	Smyrna.....	1,665	Hamden.....	1,648
Sandford.....	3,659	Asylums, Prisons, &c.....	61,213	Asylums, Prisons, &c.....	29	Hancock.....	3,176
Triangle.....	2,122					Harpersfield.....	1,154
Union.....	2,638	Chautauqua.		Clinton.	89,937	Kortright.....	1,679
Vestal.....	2,026	Arkwright.....	1,151	Altona.....	3,450	Masonville.....	1,660
Windoor.....	3,224	Busti.....	1,822	Asuable.....	3,207	Meredith.....	1,390
Asylums, Prisons, &c.....	60	Carroll.....	1,827	Beekmantown.....	2,383	Middletown.....	3,029
	47,913	Charlotte.....	1,706	Black Brook.....	3,443	Roxbury.....	2,311
Cattaraugus.		Chautauqua.....	3,153	Champlain.....	5,411	Sidney.....	2,381
Allegany.....	2,543	Cherry Creek.....	1,582	Chazy.....	3,074	Stamford.....	1,571
Ashford.....	1,891	Clymer.....	1,408	Clinton.....	2,377	Tompkins.....	4,138
		Dunkirk.....	7,655			Watson.....	3,367

POPULATION OF THE STATE OF NEW YORK.

Asylums, Prisons, &c.	35
Dutchess.	42,149
Amenia	2,795
Beekman	1,554
Clinton	1,693
Dover	2,180
East Fishkill	2,488
Fishkill	13,471
Hyde Park	2,771
La Grange	1,800
Milan	1,416
North East	2,266
Pawling	1,907
Pine Plains	1,414
Pleasant Valley	1,827
Poughkeepsie	4,294
*Poughkeepsie	19,859
Red Hook	4,229
Rhinebeck	3,777
Stanford	2,139
Union Vale	1,446
Washington	2,670
Erie.	76,056
Alden	2,582
Amherst	4,807
Aurora	2,577
Boston	1,577
Brandt	1,378
*Buffalo	134,573
Cheektowaga	2,298
Clarence	3,349
Colden	1,550
Collins	1,946
Concord	3,186
East Hamburg	2,392
Eden	2,320
Elma	2,812
Evans	2,786
Grand Island	1,072
Hamburg	3,096
Holland	1,636
Lancaster	4,227
Marilla	1,867
Newstead	3,493
North Collins	1,689
Sardinia	1,693
Tonawanda	4,278
Wales	1,439
West Seneca	3,446
Reservations	1,251
Asylums, Prisons, &c.	250
	199,570
Essex.	
Chesterfield	3,019
Crown Point	3,161
Elizabethtown	1,461
Essex	1,782
Jay	2,459
Keene	758
Lewis	1,744
Minerva	962
Moriah	7,898
Newcomb	183
North Elba	367
North Hudson	720
Schroon	1,514
St. Armand	414
Ticonderoga	3,401
Westport	1,981
Willsborough	1,764
Wilmington	876
Asylums, Prisons, &c.	10
	34,474
Franklin.	
Bangor	2,271
Bellmont	2,088
Bombay	1,397
Brandon	742
Brighton	247
Burke	2,116
Chateaugay	2,727
Constable	1,586
Dickinson	2,023
Duane	289
Fort Covington	2,421

Franklin	1,094
Harrietstown	491
Malone	7,335
Moirs	2,283
Westville	1,722
St. Regis Indian Res.	737
Asylums, Prisons, &c.	13
	31,581
Fulton.	
Bleecker	949
Broadalbin	2,409
Caroga	884
Ephratah	2,110
Johnstown	15,656
Mayfield	2,352
Northampton	1,993
Oppenheim	1,851
Perth	936
Stratford	1,031
Asylums, Prisons, &c.	17
	30,188
Genesee.	
Alabama	1,810
Alexander	1,550
Batavia	6,942
Bergen	1,971
Bethany	1,573
Byron	1,703
Darien	2,084
Elba	1,942
Le Roy	4,754
Oakfield	1,471
Pavilion	1,634
Pembroke	2,856
Stafford	1,818
P't Tona'da Ind. Res.	427
Asylums, Prisons, &c.	16
	32,551
Greene.	
Ashland	938
Athens	3,476
Cairo	2,246
Catskill	8,020
Coxsackie	4,000
Durham	2,214
Greenville	2,034
Halcott	391
Hunter	1,490
Jewett	1,119
Lexington	1,316
New Baltimore	2,669
Prattsville	1,123
Windham	1,492
Asylums, Prisons, &c.	16
	32,544
Hamilton.	
Arietta	231
Benson	356
Hope	705
Indian Lake	425
Lake Pleasant	332
Long Lake	299
Morehouse	163
Wells	970
Asylums, Prisons, &c.	1
	3,482
Herkimer.	
Columbia	1,590
Danube	1,239
Fairfield	1,573
Frankfort	3,425
German Flats	7,402
Herkimer	3,256
Litchfield	1,250
Little Falls	5,871
Manheim	2,179
Newport	1,792
Norway	1,054
Ohio	987
Russia	2,055
Salisbury	1,882
Schuyler	1,500
Stark	1,398
Warren	1,461
Wilmurt	185

Winfield	1,540
Asylums, Prisons, &c.	53
	41,692
Jefferson.	
Adams	3,334
Alexandria	3,476
Antwerp	3,393
Brownville	2,876
Cape Vincent	3,188
Champion	2,246
Clayton	4,215
Ellisburgh	4,819
Henderson	1,815
Hounsfield	2,552
Le Ray	2,733
Lorraine	1,377
Lyme	2,244
Orleans	2,307
Pamela	1,055
Philadelphia	1,709
Rodman	1,468
Rutland	1,849
Theresa	2,361
Watertown	1,279
*Watertown	10,041
Wilna	4,265
Worth	7,67
Asylums, Prisons, &c.	23
	65,362
Kings.	
*Brooklyn	484,616
Flatbush	4,968
Flatlands	2,654
Gravesend	2,182
New Lots	10,765
New Utrecht	3,805
Asylums, Prisons, &c.	236
	5,09,216
Lewis.	
Croghan	2,834
Denmark	1,984
Diana	1,925
Greig	1,633
Harrsburgh	1,014
High Market	1,068
Lewis	1,207
Leiden	1,975
Lowville	2,804
Lyonsdale	14,16
Martinsburgh	2,144
Montague	732
New Bremen	2,194
Osceola	649
Pinckney	1,145
Turin	1,396
Watson	1,265
West Turin	1,844
Asylums, Prisons, &c.	7
	29,236
Livingston.	
Avon	3,325
Caledonia	1,981
Conesus	1,377
Genesee	3,118
Groveland	1,373
Leicester	1,662
Lima	2,921
Livonia	2,898
Mount Morris	3,817
North Dansville	40,84
Nunda	2,703
Ossian	1,144
Portage	1,172
Sparta	1,141
Springwater	2,129
West Sparta	1,208
York	2,483
Asylums, Prisons, &c.	28
	38,564
Madison.	
Brookfield	3,516
Cazenovia	4,256
De Ruyter	1,613
Eaton	3,558
Fenner	1,268

Georgetown	1,427
Hamilton	3,725
Lebanon	1,475
Lenox	9,440
Madison	2,439
Nelson	1,662
Smithfield	1,252
Stockbridge	1,970
Sullivan	47,61
Part Oneida Reserv.	79
Asylums, Prisons, &c.	39
	42,490
Monroe.	
Brighton	2,964
Chili	2,287
Clarkson	1,922
Gates	1,997
Greece	4,860
Henrietta	2,325
Hamlin	2,322
Irondequoit	1,875
Mendon	2,988
Ogden	2,977
Parma	2,963
Penfield	2,880
Perrinton	8,873
Pittsford	2,215
Riga	1,999
*Rochester	31,673
Rush	1,699
Sweden	5,164
Webster	2,619
Wheatland	2,629
Asylums, Prisons, &c.	103
	134,534
Montgomery.	
Amsterdam	9,064
Canajoharie	4,248
Charleston	1,403
Florida	3,065
Glen	2,624
Minden	4,685
Mohavk.	2,887
Palatine	2,713
Root	2,292
St. Johnsville	2,199
Asylums, Prisons, &c.	20
	35,200
New York.	
*New York	1,046,037
Niagara.	
Cambria	2,022
Hartland	3,235
Lewiston	2,829
Lockport	2,842
*Lockport	12,624
Newfane	3,300
Niagara	6,876
Penfieldton	1,675
Porter	2,102
Royalton	4,990
Somerset	1,918
Wheatfield	4,168
Wilson	2,847
Reservations	414
Asvlms, Prisons, &c.	62
	51,904
Oneida.	
Annsville	2,634
Augusta	22,38
Ava	1,026
Boonville	4,118
Bridgewater	1,309
Camden	3,558
Deerfield	2,104
Florence	2,192
Floyd	1,141
Forestport	1,284
Kirkland	4,760
Lee	2,425
Marcy	1,232
Marshall	2,220
New Hartford	4,397
Paris	3,596
Remsen	1,173

POPULATION OF THE STATE OF NEW YORK.

*Rome	11,922
Sangerfield	2,921
Steuben	1,321
Trenton	3,134
*Utica	32,070
Vernon	3,013
Verona	5,487
Vienna	3,073
Western	2,250
Westmoreland	2,737
Whitestown	4,334
Part Oneida Ind. Res.	60
Asylums, Prisons, &c.	75

Onondaga.	
	113,967
Camillus	2,613
Cicero	2,803
Clay	3,025
De Witt	3,137
Elbridge	4,220
Fabius	1,961
Geddes	5,526
Lafayette	2,194
Lysander	4,999
Manlius	6,357
Marcellus	2,501
Onondaga	6,038
Otisco	1,534
Pompey	3,342
Salina	2,964
Skaneateles	5,049
Stafford	1,488
*Syracuse	48,315
Tully	1,473
Van Buren	3,183
Onondaga Ind. Res.	401
Asylums, Prisons, &c.	95

Ontario.	
	113,223
Bristol	1,597
Canadice	832
Canandaigua	7,765
East Bloomfield	2,420
Farmington	1,949
Geneva	7,557
Gorham	2,427
Hopewell	1,825
Manchester	3,744
Naples	2,488
Pelphs	5,267
Richmond	1,659
Seneca	2,681
South Bristol	1,251
Victor	2,648
West Bloomfield	1,570
Asylums, Prisons, &c.	50
	47,730

Orange.	
	2,465
Blooming Grove	2,256
Chester	3,615
Cornwall	1,988
Crawford	1,988
Deerpark	11,115
Goshen	4,065
Greenville	1,065
Hamptonburgh	1,152
Highlands	2,953
Minisink	1,495
Monroe	4,957
Montgomery	4,514
Mount Hope	1,700
Newburgh	3,542
*Newburgh	17,327
New Windsor	2,461
Walkill	10,579
Warwick	5,864
Wawayanda	2,057
Asylums, Prisons, &c.	82
	85,252

Orleans.	
	5,447
Albion	2,356
Barre	2,406
Carlton	1,760
Clarendon	2,156
Gaines	1,750
Kendall	1,750

Murray	2,649
Ridgeway	5,548
Shelby	3,874
Yates	2,012
Asylums, Prisons, &c.	19
	29,977

Oswego.	
	2,479
Albion	1,279
Amboy	1,132
Boylston	3,491
Constantia	4,173
Granby	3,254
Hannibal	2,931
Hastings	3,761
Mexico	1,728
New Haven	1,457
Orwell	2,978
Oswego	22,455
*Oswego	2,048
Palermo	2,062
Parish	1,304
Redfield	4,023
Richland	2,736
Sandy Creek	3,262
Schroepfel	3,120
Scriba	5,775
Volney	1,321
West Monroe	1,815
Williamstown	1,815
Asylums, Prisons, &c.	31
	78,615

Otsego.	
	1,130
Burlington	2,046
Butternuts	2,244
Cherry Valley	741
Decatur	1,751
Edmeston	1,326
Exeter	2,188
Hartwick	1,874
Laurens	2,365
Maryland	2,693
Middlefield	2,294
Milford	2,303
Morris	1,546
New Lisbon	3,995
Oneonta	1,972
Otego	4,470
Otsego	1,521
Pittsfield	1,182
Plainfield	2,151
Richfield	1,493
Roseboom	1,945
Springfield	2,547
Unadilla	1,256
Westford	2,417
Worcester	49,815
Asylums, Prisons, &c.	25

Putnam.	
	2,801
Carmel	1,403
Kent	1,526
Patterson	5,163
Phillipstown	1,845
Putnam Valley	3,066
South East	7
Asylums, Prisons, &c.	15,811

Queens.	
	15,367
Flushing	14,802
Hempstead	8,999
Jamaica	15,609
*Long Island City	10,631
Newtown	7,199
North Hempstead	11,462
Oyster Bay	62
Asylums, Prisons, &c.	84,131

Rensselaer.	
	2,252
Berlin	3,237
Brunswick	2,067
East Greenbush	1,625
Grafton	7,072
Greenbush	6,530
Hoosick	6,937
Lansingburgh	2,252

Nassau	3,940
North Greenbush	1,718
Petersburgh	3,967
Pittstown	1,727
Poestenkill	2,576
Sandlake	3,275
Shaghticoke	4,458
Schodack	2,048
Stephentown	48,821
*Troy	143
Asylums, Prisons, &c.	105,053

Richmond.	
	11,007
Castleton	8,351
Middletown	6,529
Northfield	4,448
Southfield	4,883
Westfield	23
Asylums, Prisons, &c.	35,241

Rockland.	
	4,535
Clarkstown	6,791
Haverstraw	7,208
Orangetown	5,119
Ramapo	3,274
Stony Point	2,274
Asylums, Prisons, &c.	26,951

St. Lawrence.	
	3,486
Brasher	6,018
Canton	85
Clifton	1,586
Colton	3,044
De Kalb	1,221
De Peyster	1,094
Edwards	760
Fine	1,633
Fowler	3,830
Gouverneur	1,815
Hammond	1,806
Herron	1,956
Hopkinton	2,641
Lawrence	4,211
Lisbon	2,039
Louisville	1,760
Macomb	1,968
Madrid	2,709
Massena	1,849
Morristown	2,476
Norfolk	13,204
*Oswegatchie	2,043
Parisville	2,310
Pierrepont	868
Pitcairn	7,417
Potsdam	1,765
Rossie	2,417
Russell	3,550
Stockholm	2,516
Waddington	2,516
Asylums, Prisons, &c.	84,124
*Includes city of Ogdensburg.	

Saratoga.	
	1,946
Ballston	1,589
Charlton	2,505
Clifton Park	1,660
Cornith	1,199
Day	1,435
Edinburgh	1,945
Galway	2,692
Greenfield	1,067
Hadley	3,188
Halfmoon	1,215
Malta	5,277
Milton	2,315
Moreau	1,694
Northumberland	1,133
Providence	4,522
Saratoga	10,775
Saratoga Springs	3,439
Stillwater	4,392
Waterford	1,218
Wilton	37
Asylums, Prisons, &c.	55,233

Schenectady.	
	2,930
Duanesburgh	2,835
Glenville	1,112
Niskayuna	892
Princtown	2,849
Rotterdam	12,748
*Schenectady	26
Asylums, Prisons, &c.	22,892

Schoharie.	
	1,170
Blenheim	1,705
Broome	1,634
Carlisle	3,160
Cobleskill	1,174
Conesville	1,315
Esperance	2,603
Fulton	2,171
Gilboa	1,536
Jefferson	3,268
Middleburgh	2,109
Richmondville	3,219
Schoharie	1,772
Seward	2,587
Sharon	1,467
Summit	1,504
Wright	25
Asylums, Prisons, &c.	32,419

Schuyler.	
	1,051
Catharine	669
Cayuta	4,218
Dix	4,970
Hector	1,885
Montour	1,942
Orange	1,715
Reading	1,964
Tyrone	18,928
Asylums, Prisons, &c.	2,097

Seneca.	
	3,371
Covert	1,313
Fayette	1,896
Junius	2,397
Lodi	2,073
Ovid	7,076
Romulus	1,218
Seneca Falls	1,313
Tyre	1,218
Varick	1,731
Waterloo	4,102
Asylums, Prisons, &c.	27,299

Steuben.	
	2,595
Addison	1,778
Avoca	6,660
Bath	991
Bradford	1,612
Cameron	2,990
Campbell	2,855
Canisteo	1,635
Caton	3,165
Cochocton	6,811
Corning	1,854
Dansville	2,024
Erwin	1,124
Fremont	1,321
Greenwood	964
Hartsville	1,317
Hornby	8,879
Hornellsville	2,137
Howard	1,482
Jasper	2,283
Lindley	1,444
Prattsburgh	1,393
Pultney	1,389
Thurston	2,316
Troupsburgh	1,480
Tuscarora	2,119
Urbana	2,627
Wayland	853
Wayne	1,329
West Union	1,368
Wheeler	1,978
Woodhull	

POPULATION OF THE STATE OF NEW YORK.

Asylums, Prisons, &c. 27	Tompkins.	Washington.	New Rochelle.....	4,698
Suffolk. 73,928	Caroline.....	Argyle.....	North Castle.....	1,966
Babylon.....	Danby.....	Cambridge.....	North Salem.....	1,587
Brookhaven.....	Dryden.....	Dresden.....	Ossining.....	7,203
East Hampton.....	Enfield.....	Easton.....	Pelham.....	1,540
Huntington.....	Groton.....	Fort Ann.....	Poundridge.....	1,012
Islip.....	Ithaca.....	Fort Edward.....	Rye.....	5,966
Riverhead.....	Lansing.....	Granville.....	Scarsdale.....	530
Shelter Island.....	Newfield.....	Greenwich.....	Somers.....	1,636
Smithtown.....	Ulyses.....	Hampton.....	Westchester.....	4,763
Southampton.....	Asylums, Prisons, &c. 18	Hartford.....	White Plains.....	2,727
Southold.....	32,915	Hebron.....	*Yonkers.....	17,269
Shinnecock Ind. Res. 185	Ulster.	Jackson.....	Yorktown.....	2,617
Asylums, Prisons, &c. 26	Denning.....	Kingsbury.....	Asylums, Prisons, &c. 196	
Sullivan. 52,088	Esopus.....	Putnam.....		100,660
Bethel.....	Gardiner.....	Salem.....	Wyoming.	
Callicoon.....	Hardenberg.....	White Creek.....	Arcade.....	2,039
Cohecon.....	Hurley.....	Whitehall.....	Attica.....	3,064
Delaware.....	Kingston.....	Asylums, Prisons, &c. 21	Bennington.....	2,486
Fallsburgh.....	*Kingston.....	48,167	Castile.....	2,277
Forestburgh.....	Lloyd.....	Wayne.	Covington.....	1,132
Fremont.....	Marbletown.....	Arcadia.....	Eagle.....	1,043
Highland.....	Marlborough.....	Butler.....	Gainesville.....	1,715
Liberty.....	New Paltz.....	Galen.....	Genesee Falls.....	909
Lumberland.....	Olive.....	Huron.....	Java.....	1,933
Mamakating.....	Plattekill.....	Lyons.....	Middlebury.....	1,734
Neversink.....	Rochester.....	Macedon.....	Orangeville.....	1,106
Rockland.....	Rosendale.....	Marion.....	Perry.....	2,421
Thompson.....	Saugerties.....	Ontario.....	Pike.....	1,727
Tusten.....	Shandaken.....	Palmyra.....	Sheldon.....	2,277
Asylums, Prisons, &c. 18	Shawangunk.....	Rose.....	Warsaw.....	3,441
Tioga. 34,935	Woodstock.....	Savannah.....	Wethersfield.....	1,259
Barton.....	Asylums, Prisons, &c. 93	Sodus.....	Asylums, Prisons, &c. 12	
Berkshire.....	88,271	Walworth.....		30,595
Candor.....	Warren.	Williamson.....	Yates.	
Newark Valley.....	Bolton.....	Wolcott.....	Barrington.....	1,440
Nichols.....	Caldwell.....	Asylums, Prisons, &c. 22	Benton.....	2,410
Owego.....	Chester.....	49,882	Italy.....	1,335
Richford.....	Hague.....	Westchester.	Jerusalem.....	2,507
Spencer.....	Horicon.....	Bedford.....	Middlesex.....	1,359
Tioga.....	Johnsburgh.....	Cortlandt.....	Milo.....	5,008
Asylums, Prisons, &c. 18	Luzerne.....	East Chester.....	Potter.....	1,918
31,744	Queensbury.....	Greenburgh.....	Starkey.....	2,448
	Stony Creek.....	Harrison.....	Torrey.....	1,232
	Thurman.....	Lewisburgh.....	Asylums, Prisons, &c. 9	
	Warrensburgh.....	Mamaroneck.....		19,686
	Asylums, Prisons, &c. 8	Mount Pleasant.....		
	23,295	New Castle.....		

Number of cities in New York State, 24 ; number of towns, 936 ; number of counties, 60.

POPULATION OF RHODE ISLAND.

*Denotes cities.

CENSUS OF 1875.

Total.			258,239.
Bristol.	Newport.	East Providence.	Washington.
Barrington.....	Jamestown.....	4,323	Charlestown.....
1,185	488	1,543	1,054
Bristol.....	Little Compton.....	Glocester.....	Exeter.....
5,829	1,156	2,098	1,355
Warren.....	Middletown.....	Johnston.....	Hopkinton.....
4,005	1,074	4,999	2,700
Kent.	*Newport.....	Lincoln.....	North Kingstown.....
11,019	1,028	21,565	3,505
Coventry.....	New Shoreham.....	North Providence.....	South Kingstown.....
4,580	1,147	1,203	4,240
East Greenwich.....	Portsmouth.....	North Smithfield.....	Richmond.....
3,120	1,893	2,797	1,730
West Greenwich.....	Tiverton.....	Pawtucket.....	Westerly.....
1,034	2,101	18,454	5,408
Warwick.....	21,887	*Providence.....	
11,614	21,887	100,675	
Providence.	Burrillville.....	Scituate.....	
20,348	5,249	4,101	
	Cranston.....	Smithfield.....	
	5,698	2,857	
	Cumberland.....	Woonsocket.....	
	5,673	13,576	
		184,924	

POPULATION OF THE UNITED STATES.

Alabama.....	996,961	Mississippi.....	834,170	Wisconsin.....	1,055,167
Arkansas.....	483,179	Missouri.....	1,715,000	Total States.....	33,108,659
California.....	560,285	Nebraska.....	123,000	Territories.	
Connecticut.....	537,418	Nevada.....	42,491	Arizona.....	9,658
Delaware.....	125,015	New Hampshire.....	318,300	Colorado.....	89,706
Florida.....	187,756	New Jersey.....	905,794	Dakota.....	14,181
Georgia.....	1,200,609	New York.....	4,380,322	Idaho.....	14,998
Illinois.....	2,536,638	North Carolina.....	1,089,614	Montana.....	20,594
Indiana.....	1,673,046	Ohio.....	2,669,214	New Mexico.....	81,852
Iowa.....	1,191,802	Oregon.....	90,922	Utah.....	66,790
Kansas.....	302,872	Pennsylvania.....	3,515,993	Washington.....	28,901
Kentucky.....	1,321,001	Rhode Island.....	217,356	Wyoming.....	9,118
Louisiana.....	732,731	South Carolina.....	728,000	Dist. of Columbia.....	181,706
Maine.....	626,463	Tennessee.....	1,257,983	Totals.....	38,551,159
Maryland.....	780,894	Texas.....	797,500		
Massachusetts.....	1,457,351	Vermont.....	380,552		
Michigan.....	1,184,290	Virginia.....	1,224,890		
Minnesota.....	436,511	West Virginia.....	445,616		

POPULATION OF CONNECTICUT.

CENSUS OF 1870.

Total		537,454	
Fairfield.			
Bethel	2,311	Cornwall	1,772
Bridgeport	19,835	Goshen	1,223
Brookfield	1,193	Harwinton	1,044
Danbury	8,753	Kent	1,744
Darien	1,808	Litchfield	3,113
Easton	1,288	Morris	701
Fairfield	5,645	New Hartford	3,078
Greenwich	7,644	New Milford	3,586
Huntington	1,527	Norfolk	1,641
Monroe	1,226	North Canaan	1,695
New Canaan	2,497	Plymouth	4,149
New Fairfield	870	Roxbury	919
Newtown	3,681	Salisbury	3,303
Norwalk	12,119	Sharon	2,441
Redding	1,624	Torrington	2,893
Ridgefield	1,919	Warren	673
Sherman	846	Washington	1,563
Stamford	9,714	Watertown	1,698
Stratford	3,032	Winchester	4,096
Trumbull	1,335	Woodbury	1,931
Weston	1,054		48,727
Westport	3,361	Middlesex.	
Wilton	1,994	Chatham	2,771
	95,276	Chester	1,094
Hartford.			
Avon	987	Clinton	1,404
Berlin	2,436	Cromwell	1,856
Bloomfield	1,473	Durham	1,086
Bristol	3,788	East Haddam	2,951
Burlington	1,319	Essex	1,669
Canton	2,639	Haddam	2,071
East Granby	853	Killingworth	856
East Hartford	3,007	Middlefield	1,053
East Windsor	2,882	Middletown	11,126
Enfield	6,322	Old Saybrook	1,215
Farmington	2,616	Portland	4,693
Glastonbury	3,560	Saybrook	1,267
Granby	1,517	Westbrook	987
Hartford	37,743		36,099
Hartland	789	New Haven.	
Manchester	4,223	Bethany	1,135
Marlborough	476	Branford	2,488
New Britain	9,480	Cheshire	2,344
Plainville	1,433	Derby	8,020
Rocky Hill	971	East Haven	2,714
Simsbury	2,051	Guilford	2,576
Southington	4,314	Hamden	3,028
South Windsor	1,688	Madison	1,814
Suffield	3,277	Meriden	10,495
West Hartford	1,533	Middlebury	696
Wethersfield	2,693	Milford	3,405
Windsor	2,783	Naugatuck	2,830
Windsor Locks	2,154	New Haven	50,840
	109,007	North Branford	1,035
Litchfield.			
Barkhamsted	1,439	North Haven	1,771
Bethlehem	750	Orange	2,634
Bridgewater	877	Oxford	1,338
Canaan	1,257	Prospect	551
Colebrook	1,141	Seymour	2,122
		Southbury	1,318
		Wallingford	3,676
		Waterbury	13,106
		Wolcott	491
		Woodbridge	880
			121,257
		New London.	
		Bozrah	984
		Colchester	3,383
		East Lyme	1,506
		Franklin	731
		Griswold	2,575
		Groton	5,124
		Lebanon	2,211
		Ledyard	1,392
		Lisbon	502
		Lyme	1,181
		Montville	2,495
		New London	9,576
		North Stonington	1,759
		Norwich	16,653
		Old Lyme	1,362
		Preston	2,161
		Salem	717
		Sprague	3,463
		Stonington	6,313
		Waterford	2,482
			66,570
		Tolland.	
		Andover	461
		Bolton	576
		Columbia	891
		Coventry	2,057
		Ellington	1,452
		Hebron	1,279
		Mansfield	2,401
		Somers	1,247
		Stafford	3,405
		Tolland	1,216
		Union	627
		Vernon	5,446
		Willington	942
			22,000
		Windham.	
		Ashford	1,241
		Brooklyn	2,354
		Canterbury	1,543
		Chaplin	704
		Eastford	984
		Hampton	891
		Killingly	5,712
		Plainfield	4,521
		Pomfret	1,488
		Putnam	4,192
		Scotland	643
		Sterling	1,022
		Thompson	3,804
		Voluntown	1,052
		Windham	5,412
		Woodstock	2,955
			38,518

BLOCKS, BUILDINGS, &c.

AGRICULTURAL BUILDINGS, 106 West Main
 ARCADE, 24 to 34 West Main
 ARNOLD'S BLOCK, 109 State
 ARSENAL BUILDINGS, Monroe avenue cor. S. Clinton
 BAKTZEL'S BLOCK, N. Clinton corner Marietta
 BAKER'S BLOCK, West Main corner Fitzhugh
 BRIGGS' BLOCK, West Main corner Plymouth av.
 BROWN BLOCK, rear State near Brown
 BUCKLAND BLOCK, 22 to 26 S. St. Paul
 CITY HALL, Fitzhugh corner Erie canal
 CRYSTAL PALACE, 79 to 85 East Main
 COCHRANE BLOCK, 318 State
 CORINTHIAN HALL BUILDING, Exchange Place
 COURT HOUSE, West Main corner Fitzhugh
 DAILY UNION BUILDINGS, 82 to 86 West Main
 ELWOOD BLOCK, West Main corner State
 FILON'S BLOCK, 139 East Main
 FISKE'S BUILDINGS, foot Furnace
 GOULD'S BLOCK, State corner Exchange place
 GREENWOOD'S BUILDING, 124 Mill near Furnace
 HAAG BLOCK, East Main corner Scio
 HAMILTON'S BLOCK, 79 State
 HART'S BLOCK, East Main corner North avenue
 HOLLISTER BUILDING, Exchange opposite Spring
 HOWE'S BUILDING, 38 to 45 Fitzhugh
 HYDRAULIC BUILDINGS, foot Mill
 JOHNSTON BLOCK, 28 to 34 South St. Paul
 JORDAN BLOCK, 133 to 135 East Main
 KOLB'S BLOCK, North Clinton corner Atwater

LAMPERT'S BLOCK, 73 to 91 North Water
 MASONIC HALL BUILDING, West Main cor. Exchange
 MCCLELLAN BLOCK, 33 Scio
 METROPOLITAN BLOCK, East Main cor. South St. Paul
 MUNGER BLOCK, South St. Paul cor. East Main
 ODD FELLOWS' HALL BUILDING, E. Main c. N. St. Paul
 ODD FELLOWS' TEMPLE, 117 West Main
 PAINES'S BUILDINGS, 20 and 22 West Main
 PALMER'S BLOCK, 136 to 144 East Main
 PHENIX BUILDING, 8 North Clinton
 PITKIN BLOCK, 14 to 18 West Main
 POWERS' COMMERCIAL FIRE PROOF BUILDINGS, West Main corner State (see page 500)
 ROCHESTER SAVINGS BANK BUILDING, West Main corner Fitzhugh
 SCHLEYER BLOCK, East Main corner Lancaster
 SHAWMUT BUILDING, Mill near Factory
 SIBLEY'S BLOCK, 175 to 205 East Main
 SMITH'S BLOCK, 55 to 69 West Main
 STILLSON BLOCK, 169 to 173 East Main
 TEMPERANCE BUILDINGS, 94 to 102 State c. Mumford
 TORONTO BLOCK, State corner Brown
 UNIVERSITY BLOCK, 184 West Main
 WALBRIDGE'S BLOCK, State corner Allen
 WASHINGTON HALL BUILDING, 128 to 132 East Main
 WAWERLEY BLOCK, 150 State corner Railroad av.
 YOUNG MEN'S CATHOLIC ASSOCIATION BUILDING, 118 West Main

HALLS.

ARION HALL, North Clinton cor. Marietta
 CORINTHIAN HALL, Exchange place
 EMPIRE HALL, West Main corner Sophia
 FLOUR CITY HALL, East Main corner Stone
 JENNY'S HALL, North Clinton corner Franklin
 LEONHARDT'S HALL, 61 Jay
 MÄNNERCHOR HALL, North Clinton corner Atwater
 MASONIC TEMPLE, 14 Exchange

ODD FELLOWS' HALL, East Main corner N. St. Paul
 SCHAAD'S HALL, South avenue corner Sanford
 SCHLITZER'S HALL, N. Clinton corner Franklin
 TREVOR HALL, East avenue corner Alexander
 GERMANIA HALL, 175 North Clinton
 WASHINGTON HALL, East Main corner N. Clinton
 SIBLEY HALL, Prince corner College avenue
 STONE'S HALL, South St. Paul

AREA OF ROCHESTER.

Area of Wards, 1 to 14 (not including river),.....	5,430 Acres.
Area of Ward 15.....	1,397 "
Area of Ward 16.....	3,834 "
Total.....	11,161 "

THE American Rural Home,

A First-Class Weekly Journal for Ruralists Everywhere.

A. A. HOPKINS and P. C. REYNOLDS,
 Editors and Proprietors, 31 Arcade, Rochester, N. Y.

THE RURAL HOME is confessedly the handsomest Sheet of its kind in the World, and
The only one published in Western New York.

TERMS.

Single Subscriptions, \$2.00. Two Copies for \$3.00.
 Liberal Inducements to Agents.

Address THE RURAL HOME,
 ROCHESTER, N. Y.

STREET DIRECTORY.

The Street Directory gives the location of each street, and shows what other streets or places run from it or across it, with the number at which they intersect.

From this list the location of any number on a street can be easily ascertained. As, for instance, wishing to know at what part of State street No. 265 comes, look at State street and you find that Brown street runs from 255 left side, and Jay street from 293, showing that No. 265 comes on the left side of State street between Brown and Jay.

Achilles, from 14 North, east, to 4 Stillson; wd. 14

Ackerman, fr Bay, south, to Plank road; wd 16

Adams, fr Genesee river w. to Frances; wds. 3, 8

Left. Rt.

— Exchange

— Fitzhugh

2 1 Plymouth av.

46 47 Caledonia av.

64 59 South Ford

— Gen. Val. canal

107 Prospect

126 123 Reynolds

— Frances

Aldern, from Perkins, north, to Deep Hollow; ward 9

Alexander, from 55 Mt. Hope av., northeast, to Bay; wards 7, 10, 12, 16

Left. Rt.

1 2 Mt. Hope avenue

6 Jefferson park

33 36 South avenue

50 Van

65 66 Pinnacle avenue

— Erie canal

77 78 Broadway

— Pearl

— Cobb

97 98 Monroe avenue

— Tracy Park

— 122 Park avenue

143 Gardiner park

165 164 East avenue

— Charlotte

187 Asylum

195 194 University av.

— Main

— Weld

— Ontario

— N. Y. Cen. R. R.

— Pennsylvania av.

— N. Union

— Central park

— German

— Dake

— Bay

Alexander Park, from 8 Comfort, south; ward 12

Allen, fr. 137 State, west, to 221 Brown; ws. 1, 2, 8

Left. Rt.

1 2 State

3 Pindell alley

7 North Fitzhugh

14 Frankfort alley

17 18 Montgomery al.

27 28 Sophia

29 Scott alley

— John

23 36 John

23 N. Washington

27 Elizabeth

42 Kent

— N. Y. Cen. R. R.

55 North Ford

56 Oak

Left. Rt.

64 Warehouse

79 72 Broad

— Erie canal

— Canal

95 96 Litchfield

105 King

117 118 Brown

Allen's Alley, from 8 South Clinton, west, to Stone; ward 4

Almeroth, fr. Henrietta avenue, east, to canal; ward 16

Almira, from Gorham, north, across Lowell; ward 5

Alphonse, from Thomas, east, to Carter; ward 16

Ambrose, from Genesee river, west, to Saratoga avenue; ward 9

Left. Rt.

— Cliff

— Lake avenue

— Jones avenue

21 20 Frank

49 48 Saratoga avenue

Anderson Avenue, from Goodman, easterly, to University av. ward 16

Ames, fr'm West avenue, north, to Jay; ward 15

Amity, from 41 North, west, to 8 South Chatham; ward 6

Andrews, from Genesee river, east, to 49 North; continuation of Munford; wards 5, 6

Left. Rt.

— North Water

15 14 North St. Paul

35 34 Franklin

39 — North Clinton

59 Franklin square

46 South Chatham

69 74 North

Anne, from Otis, north; ward 15

Anson Park, from 113 East avenue, south, to Gardiner park; ward 7

Aqueduct, from 17 Buffalo, south; ward 1

Arcade, from 28 Buffalo, north, to 11 Exchange place; ward 1

Arklow, fr. Terry, south-west, to New York; ward 8

Arlington, from University avenue, north, to Anderson ave.; wd 16

Arnold Park, from East avenue, south, to Park avenue; ward 7

Ashland, from 19 Munger, south, to 35 Sanford; ward 12

Left. Rt.

1 2 Munger

— Hickory

— Gregory

— Sanford

Asylum, from 45 Scio, east, to 187 Alexander; ward 10

Left. Rt.

1 2 Main

43 48 Union

73 74 Alexander

Atkinson, from 73 Plymouth avenue, west, to Reynolds; wards 3, 8

Left. Rt.

1 2 Plymouth av.

12 S. Washington

24 Greenwood

33 34 Eagle

38 Peach alley

46 Pear alley

47 48 Caledonia av.

63 64 South Ford

— Gen. Val. canal

156 Julia

— Prospect

— Reynolds

Atwater, fr. 159 North Water, east, to 103 North wards 5, 6

Left. Rt.

— North Water

— North St. Paul

11 Pitt

25 22 North Clinton

39 Joiner

45 49 St. Joseph

61 56 Chatham

77 Leopold

78 Rome

89 Oregon

97 94 North

Augusta, from Scio to North Union; ward 10

Averell, from Whalin, north-east, to 164 Monroe avenue; wards 7, 12

Left. Rt.

— Whalin

— Munger

— Bond

— Cayuga

— Erie canal

— Broadway

— Pearl

— Cobb

— Monroe avenue

Avenue A, from North St. Paul, below Clifford, east, to city line; wd. 5

Avenue B, from North St. Paul, below Clifford, east, to city line; wd. 5

Avenue C, from North St. Paul, below Clifford, east, to city line; wd. 5

Avenue D, from North St. Paul, below Clifford, east, to city line; wd. 5

Avenue E, from North St. Paul, below Clifford, east, to city line; wd. 5

Backus Avenue, from Bloss, north, by House of Refuge; ward 9

Left. Rt.

— Phelps avenue

— Bloss

Baden, from 106 St. Joseph, east, to 73 Hudson; ward 13

Left. Rt.

1 2 St. Joseph

14 Chatham

37 36 Hanover

67 66 Hudson

Bank Court, from 4 Exchange place, north, ward 1

Barth, fr. Vienna north; ward 13

Bartlett, from 181 Plymouth avenue, west, to Genesee; ward 8

Left. Rt.

— Plymouth av.

41 — Seward

77 — Reynolds

— Frances

— Genesee

Barton, fr. Plymouth av. near Cottage, west, to Genesee; ward 8

Bates, from Bowen, east, to Culver; ward 16

Bauer, fr. Sherman west; ward 15

Bay, from North avenue, east, to Culver; wards 14, 16

Left. Rt.

— North Avenue.

— Zimmer

— Miller

— First avenue

— Second avenue

— Third avenue

— Fourth avenue

— Fifth avenue

— Sixth avenue

— Seventh avenue

— Eighth avenue

Beach, from 272 N. St. Paul near City line, east, to Parkland; ward 5

Berlin, from Hudson near Clifford, west; ward 16

Bernard, from Maria east to Hudson; ward 16

Bethlehem Park, from Moulson, east; wd. 16

Bismarc, from Genesee west; ward 8

Bismarc Place, from 117 N. St. Paul, west, to the river; ward 5

Blumenthal, from North Clinton east; ward 16
 — — Goodman
 — — Culver (city line)
Bloomington Avenue, from North Clinton n. Hollenbeck, east; wd. 16
Bloss, from 36 Fulton av. west, to Vernon; wd. 9
Left. Rt.
 — — Fulton avenue
 — — Frank
 — — Backus avenue
 — — Vernon
Boardman, from Monroe avenue, south, to canal; ward 16
Bolivar, fr. 36 Jay, north west, to Lyell; ward 9
Left. Rt.
 1 2 Jay
 31 30 Smith
 77 Lind
 85 82 Lyell
Bond, from 66 Hamilton place, south, to 31 Grand; ward 12
Left. Rt.
 — — Hamilton place
 — — Averill
 — — Grand
Borchard, from North Clinton, east, to St. Joseph; ward 16
Bowen, from Monroe av. near canal, north, to East avenue; ward 16
Briggs' Place, from 187 West avenue, south to Chili road; ward 8
Brighton, from Henrietta avenue, south-west, to Pinnacle av.; wd. 16
Brighton Avenue, from Meigs near Park avenue, east, to Goodman; ward 7
Brisbane, from Burns, west, to Deep Hollow; ward 9
Left. Rt.
 — — Burns
 — — Lake avenue
 — — Fulton avenue
Broad, from Hill, north, to Warehouse; wds. 1, 2
Broadway, fr. 36 Howell, east, to Meigs; ward 7
Left. Rt.
 — — Howell
 — — Marshall
 — — Griffith
 13 Deming
 68 69 Alexander
 88 87 Averill
 130 131 Meigs
Brown, from Mill, south west, to 172 West avenue; wards 2, 8, 11
Left. Rt.
 1 2 Mill
 11 14 State
 27 30 Brown's alley
 45 50 Frank
 63 68 Jones
 — — Kent
 — — Oak
 101 — Warehouse
 135 138 Erie canal
 143 — Litchfield
 144 Magne
 201 King
 221 Allen
 238 Clark
 268 Wilder
 268 Tonawanda

Left. Rt.
 — — N. Y. C. R. R.
 255 East Maple
 257 North Frances
 290 West Maple
 293 Terry
 363 Wentworth
 501 512 West avenue
Brown's Alley, from Vought, north, to 5 Lyell; wards 2, 9
Left. Rt.
 — — Vought
 — — Brown
 43 44 Jay
 — — Smith
 — — Lyell
Brown's Race, fr. Centre, north, to Brown; ward 2
Left. Rt.
 — — Centre
 — — Furnace
 — — Platt
 — — Factory
 — — Brown
Brown's Square, bounded by Brown, Jay, Kent and Jones; ward 2
Buchan Park, from 229 North Clinton, east, to St. Joseph; ward 13
Buell Avenue, from McCracken, north, to sbtt. landing; ward 9
Buffalo, changed to West Main.
Burns, changed to Hastings.
Butler, fr. Magne, east, to Erie canal; ward 11
Cady, from Seward near Hunter, west, to Frances; ward 8
Left. Rt.
 — — Seward
 — — Reynolds
 — — Frances
Caledonia Avenue, fr. 227 West Main, south to 165 Plymouth avenue; ward 3
Left. Rt.
 1 2 Buffalo
 5 Child's alley
 21 22 Spring
 41 42 Troup
 49 Garden
 61 64 Atkinson
 77 76 Adams
 93 92 Tremont
 107 Edinburgh
 110 Hunter
 117 Glasgow
 — — Plymouth av.
Caledonia Square, on Plymouth avenue, between Edinburgh and Glasgow streets; wd. 3
Cameron, from Lyell near Sherman; wd. 11
Campbell, fr. 11 Grape, west, to Hague; wards 11, 15, 16
Left. Rt.
 — — Grape
 — — Walnut
 — — Saxton
 — — Orchard
 — — Whitney
 — — Childs
 — — Hague
Canal, from 62 West av. north, to Allen; ward 8
Left. Rt.
 2 1 West avenue

Left. Rt.
 20 — East Maple
 — — Allen
Carleton, fr. University av., north, to Anderson av.; ward 16
Caroline, from 117 South avenue, east, to Pinnacle av.; ward 12
Left. Rt.
 — — South avenue
 — — Mt. Vernon av.
 — — Meigs
 — — Pinnacle ave.
Carter, from North ave. near tollgate, north to Norton; ward 16
Carthage Alley, from Andrews, north, to River; ward 5
Caspar, from 95 North ave. east, to Zimmer; ward 16
Cataract, from 103 North St. Paul, west, to Genesee river; ward 5
Catharine, from 207 N. Clinton, east, to 101 St. Joseph; ward 13
Cayuga, changed to Pinnacle avenue.
Cayuga Place, from Grand, south, to Meigs; ward 12
Cedar, from 6 Sycamore, south, to 17 Elm; wd. 4
Central Park, from N. Union opp'site German, east to Goodman; wd. 16
Centre, fr. Genesee river, west, to John; ward 2
Left. Rt.
 — — Mill
 — — State
 21 22 Otsego
 30 Frank
 35 Sophia
 44 Jones
 — — John
Centre Park, from 21 Elizabeth, west, to 10 North Ford; ward 1
Centre Square, bounded by Allen, John, Centre, and Sophia; ward 2
Champion, from Burns, west, to Deep Hollow; ward 11
Left. Rt.
 — — Burns
 — — Lake avenue
 — — Fulton avenue
Champlain, from Olean, west, to S. York; wd. 8
Left. Rt.
 — — Olean
 — — Seward
 — — Reynolds
 — — Frances
Channing, from Hudson, east, to North avenue at C line; wards 13, 14
Le Rt.
 — — Hudson
 — — North
 — — Concord avenue
 — — North avenue
Chapin, changed to Frost avenue
Charles, from 69 Jay, south, to Butler; wd. 11
Charlotte, from 27 Scio, east, to 189 Alexander; ward 10

Left. Rt.
 1 2 Scio
 4 Mathews
 18 East
 49 38 South Union
 46 Lawrence
 71 56 Alexander
Chatham, from Franklin, north, to 14 Baden; wards 6, 13
Left. Rt.
 1 2 Franklin
 15 18 Andrews
 17 23 Clinton place
 29 36 Atwater
 66 Harrison
 57 Hamburg
 71 78 Holland
 83 90 Nassau
 99 106 Kelly
 121 124 Baden
Cherry, from 209 Main, north, to 54 University avenue; ward 14
Left. Rt.
 20 23 Main
 34 Selden
 42 47 University av.
Chestnut, from 23 East avenue, south, to 39 Monroe avenue; ward 4
Left. Rt.
 1 2 East avenue
 — 4 Sycamore
 5 Chestnut park
 10 Elm
 17 James
 22 Temple
 31 32 Court
 45 George
 69 72 Monroe avenue
Chestnut Park, from 7 Chestnut, east, to 8 William; ward 4
Childs, fr. Maple, north, to Lyell, forming west boundary; ward 11
Left. Rt.
 — — Maple
 — — Wilder
 — — Campbell
 — — Orange
 — — Jay
 — — Kondolf
 — — Smith
 — — Lime
Child's Alley, from 5 Caledonia avenue, east and south, to Spring; ward 3
Church, from Ely, south; ward 4
Clarissa, from 166 Plymouth avenue, east, to Mt. Hope av.; wds. 3, 8
Left. Rt.
 — — Plymouth av.
 — — Summer alley
 — — Greig
 — — Exchange
 — — Erie R. R.
 — — Genesee river
 — — Mt. Hope avenue
Clark, from 238 Brown, west, to 16 Grape; ward 11
Left. Rt.
 — — Brown
 — — Romeyn
 — — Grape
Clarkson, from Perkins, north, to Champlon; ward 9

Cliff, from 12 Lake avenue, north-east, to Ambrose; ward 9
Left. Rt.
 — — Lake avenue
 — — White
 — — Spencer
 — — Ambrose

Clifford, from 288 North St. Paul, east, to Hudson; wards 5, 13
Left. Rt.
 — — North St. Paul
 — — Conkey avenue
 — — Clinton
 — — St. Joseph
 — — Maria
 — — Thomas
 — — Henry
 — — Hudson

Clifton, fr. 32 Prospect, west, to Genesee; wd. 8
Left. Rt.
 2 1 Prospect
 16 15 Reynolds
 28 George's park
 36 37 Frances
 — — Tift
 — — Morgan
 — — Saxe
 — — Summer
 — — Genesee

Clinton, see North Clinton or South Clinton

Clinton Place, from 77 North Clinton, east, to 75 North; ward 6
Left. Rt.
 1 2 North Clinton
 11 St. Joseph
 18 Franklin square
 23 Chatham
 — — Franklin square
 35 Rome
 47 48 North

Cobb, from 86 Alexander east, to Averell; ward 7

Cole, from 36 Gorham, north, to 60 Lowell; ward 5

College, from Genesee west to Briggs' place, ward 8

College Avenue, from Prince, south-east, to Goodman; ward 10

Colvin, from West ave. north, to Campbell; ward 15

Comfort, from 33 Mt. Hope avenue, east, to 48 Pinnacle av; ward 12
Left. Rt.
 1 2 Mt. Hope avenue
 11 10 South avenue
 33 34 Pinnacle av.

Concord Avenue, from North opposite Woodbury, north, to Channing; ward 14
Left. Rt.
 — — North
 — — Draper
 — — Milo
 — — Channing

Conkey Avenue, from 13 Scrantom, north, to Clifford; ward 5

Costar, fr. Frank, west, to Erie canal; ward 9
Left. Rt.
 — — Frank
 — — Saratoga avenue

Left. Rt.
 — — Thompson
 — — Durkin alley
 — — West

Cottage, crossing Plymouth avenue near City line, west, to Genesee; ward 8

Court, from 85 Exchange, east to South Union; wards 3, 4, 7
Left. Rt.
 1 2 Exchange
 — — Genesee river
 — — South St. Paul
 19 Stone
 — — South
 31 30 South Clinton
 31 30 Lancaster
 37 34 Chestnut
 63 64 William
 78 Manhattan
 90 Savannah
 — — South Union

Crouch, from University avenue, north, to Leighton ave; ward 16

Culver, from Monroe av. at city line, north-east, to north line of city, forming the east'rly city boundary; ward 16
Left. Rt.
 — — Monroe av.
 — — Erie canal
 — — East av.
 — — N. Y. C. R. R.
 — — University av.
 — — East Main
 — — Bay

Culver Park, from Culver place, east; wd: 16

Culver Place, from University avenue, south; ward 16

Curtis, from Sherman, west; ward 15

Cypress, from 127 Mt. Hope avenue, east, to South avenue; ward 12

Dake, from Alexander to Hebard; ward 16

Date, from Davis near railroad, east, to North Union; ward 16

Davis, from 144 North, east, to boundary; wds. 10, 14
Left. Rt.
 — — North
 — — Finney
 — — Lewis
 — — Scio
 — — Hibbard

Dean, fr. 15 Frank, west, to Oak; ward 2
Left. Rt.
 — — Frank
 — — Jones
 — — John
 — — N. Y. Cen. R. R.
 — — Kent
 — — Oak

Delaware, from University avenue to Anderson avenue; ward 16

Delevan, from 82 North, east, to 68 Sciq; wd. 14
Left. Rt.
 — — North
 — — Gibbs
 67 66 Scio

Denning, from 13 Broadway, west, to Erie canal; ward 7

Diem, from Caroline, s., to Lewis; ward 12

Division, from 10 North St. Paul, east, to 12 North Clinton; ward 5

Dover, from Buchan park north; wd. 13

Draper, from 216 North, east, to Concord avenue; ward 14

Drayton, from 110 Hudson, to 235 North; ward 13

Dudley, from Weeger, to Clifford; ward 13

Durkin Alley, from 84 Lyell, north, to House of Refuge; ward 9
Left. Rt.
 — — Lyell
 — — Jones avenue
 — — Lorimer
 — — Costar

Dutton Park, from East avenue, north, to University avenue; ward 10

Eagle, from 43 Troup, south, to Atkinson; ward 3
Left. Rt.
 1 2 Troup
 — — 10 Garden
 — — Atkinson

Eagle Alley, changed to Clarkson

East, from 74 East avenue, north-east, to 18 Charlotte; ward 10
Left. Rt.
 1 2 East avenue
 14 Vine
 21 24 Charlotte

East Avenue, from 150 Main, east, to city line; wards 4, 7, 10
Left. Rt.
 2 1 Main
 18 23 Stillson
 42 Gibbs
 48 Swan
 54 Scio
 57 William
 64 Mathews
 74 East
 86 East park
 100 North Union
 101 South Union
 113 Anson park
 112 Lawrence
 — — Alexander
 224 Prince
 — — Sibley park
 261 Meigs
 — — Dutton park
 — — Arnold park
 — — Goodman
 — — Upton Park
 — — Wilder Place
 — — Hawthorn
 — — Vick Park
 — — Bowen
 — — Culver (city line)

East Main, from west end of Main st. bridge, east, to City line; wards 4, 5, 6, 10, 14
Left. Rt.
 39 North Water
 38 South Water

Left. Rt.
 43 Liberty
 57 North St. Paul
 54 North St. Paul
 76 Minerva alley
 94 Stone
 127 North Clinton
 116 South Clinton
 144 Lancaster
 155 North
 150 Elm
 152 East avenue
 — — Franklin
 167 170 Stillson
 205 196 Gibbs
 209 206 Swan
 213 Cherry
 231 230 Scio
 237 242 Asylum
 245 260 University av.
 — — North Union
 — — Alexander
 — — Prince
 — — N. Y. C. R. R.

East Maple, from 20 Canal, west, to 255 Brown; ward 8
Left. Rt.
 — — Canal
 — — Litchfield
 — — King
 — — Madison
 — — Brown

East Park, from 86 East av. near East; ward 10

Edinburgh, from Genesee river, west, to 107 Caledonia avenue; wd. 3
Left. Rt.
 — — Exchange
 — — Fitzhugh
 — — Plymouth av.
 — — Caledonia av.

Edinburgh Court, from 106 Caledonia avenue, west, to Tremont place; ward 3

Edmonds, from 208 Monroe avenue southerly to Erie canal; ward 7

Edward, from Herman, north, to Weeger; ward 13

Eighth Avenue, from Goodman, north, to Bay; ward 16

Elizabeth, from 232 West Main, north, to 27 Allen; ward 1
Left. Rt.
 1 2 West Main
 7 Hill
 15 Moore alley
 21 Centre park
 27 Hunter's alley
 29 38 Allen

Elizabeth Place, fr. 237 North Clinton, near Sellinger, east; ward 13

Elk, from University av. to Anderson av.; wd. 16

Elm, fr. 150 Main, south-east, to 10 Chestnut; ward 4
Left. Rt.
 1 2 Main
 3 Sycamore
 17 Cedar
 28 21 Chestnut

Elmwood Avenue, from Genesee River, at south line of city, east, to South avenue; ward 16

Ely, from 34 South St. Paul, east, to 14 Stone; ward 4

Emerald, from St. Joseph, east, to Hudson; ward 13

Emerson, fr. 115 Lake av. west, to City line; wd. 9

Emmett, from Hand, south, to Ward; ward 5

Erie, from 46 Kent, west to Warehouse; ward 2

Left. Rt.
 1 2 Kent
 5 6 Oak
 9 18 Warehouse

Erin, fr. Gorham, south, ward 5

Evergreen, from North St. Paul, east, to Conkey avenue; ward 5

Evergreen Park, from Evergreen, north; wd. 5

Exchange, from 37 West Main south, to Clarissa; wards 1, 3

Left. Rt.
 1 2 West Main
 47 48 Erie canal
 60 Spring
 85 Court
 114 Troup
 161 162 Adams
 195 — Edinburgh
 196 Glasgow
 224 Hubbell park
 — Greig place
 — Clarissa

Exchange Place, from 18 State, east, to 22 Front; ward 1

Left. Rt.
 2 1 State
 4 Bank Court
 11 Arcade
 12 Mill
 26 25 Front

Factory, from 228 State, east, to 149 Mill; ward 2

Fairmount, fr. University avenue, north, to Anderson avenue; wd. 16

Falls, fr. 2 Brown, south

Favor, from 1 West avenue, south, to 46 Troup; ward 3

Field, from Monroe av. south-west, to Pinnacle avenue; ward 16

Fifth Avenue, fr. Pennsylvania avenue, north, to Bay; ward 16

Finney, from Kirk to Tyler; ward 14

Left. Rt.
 — University av.
 — Delevan
 — Tappan
 — Weld
 — Kirk
 — Ontario
 — Lewis
 — Davis
 — Tyler

Finch, from Rowe, north, to McCracken; ward 15

Finney Alley, see Gibbs alley

First, from Glenwood av. north, to Rowe; wd. 9

First Avenue, fr. Pennsylvania av. north, to Bay; ward 16

Fitzhugh, from 7 Allen, south, to Edinburgh; wards 1, 3

Left. Rt.
 1 2 Allen
 — West Main
 — Erie canal
 59 60 Spring
 91 88 Troup
 — Adams
 — Edinburgh

Flint, fr. Genesee river, west, to Genesee; wd. 8

Left. Rt.
 — Mansion
 — Plymouth av.
 — Seward
 — Reynolds
 — Frances
 — Genesee

Flower, from N. Clinton near Clifford; ward 16

Foehner, from Hudson, east, to North; ward 13

Left. Rt.
 Hudson
 Frederic
 North

Ford, see North Ford, or South Ford

Fourth, from Glenwood avenue, north to Rowe; ward 9

Fourth Avenue, fr. Pennsylvania ave. north, to Bay; ward 16

Frances, from 121 West avenue, south, to Seward; ward 8

Left. Rt.
 — West avenue
 — West Troup
 — Clifton
 — Adams
 — Tremont
 — Penn
 — Marion
 — Hunter
 — Cadym
 — Champlain
 — Chapin
 — Bartlett
 — Strong
 — Flint
 — Magnolia
 — Seward

Frank, from 30 Centre, north, to Bloss; wds. 2, 9

Left. Rt.
 1 2 Centre
 15 Dean
 29 26 Platt
 39 Vought
 55 58 Brown
 79 82 Jay
 103 112 Smith
 147 142 Lyell
 148 White
 161 160 Spencer
 175 176 Ambrose
 — Jones avenue
 — Jones square
 — Lorimer
 — Montrose
 — Costar
 — Bloss

Frankfort Alley, fr. 14 Allen, opposite Fitzhugh, north, to Centre; ward 2

Franklin, from 167 Main, north-west, to 54 North St. Paul; wards 14, 6, 5

1 2 Main

Left. Rt.
 3 4 North
 10 South Chatham
 33 34 North Clinton
 — Andrews
 74 North St. Paul

Franklin Square, from 46 Andrews, north, to 18 Clinton place; ward 6

Frauenberger, from Lake avenue, east, to Genesee river; ward 15

Frederic, from Helena, north, to Foehner; ward 13

Front, from 2 Buffalo, north, to N. Y. C. R. R. depot; wards 1, 2

Left. Rt.
 2 1 Buffalo
 22 Exchange place
 56 Market
 104 93 Mumford

Frost Av., from 175 Plymouth avenue, west, to Frances; ward 8

Left. Rt.
 — Olean
 — Seward
 — Reynolds
 — Frances

Fullam's Park, from Griffith, to Erie canal; ward 7

Fulton, from Whitney, west, to Childs; wd. 11

Fulton Avenue, from Jones Avenue, north, to Brisbane; ward 9

Left. Rt.
 — Jones avenue
 — Lorimer
 36 Bloss
 — Phelps avenue
 — Emerson
 — Locust
 — Perkins
 — Champion
 — Brisbane

Furnace, from 186 State, east, to Brown's race; ward 2

Left. Rt.
 — State
 — Mill
 — Brown's race

Galusha, from Lowell, north, to Hart avenue; ward 5

Garden, from 10 Eagle, west, to 49 Caledonia avenue; ward 3

Left. Rt.
 — Eagle
 — Pear alley
 — Caledonia av.

Gardiner Park, from 143 Alexander, west, to 22 Union; ward 7

Left. Rt.
 — Alexander
 — Anson park
 — South Union

Gates Avenue, fr'm Otis, north, to city line; wd. 15

Genesee, from 177 West avenue, south to boundary; ward 8

Left. Rt.
 — West avenue
 — Clifton
 — Hunter

Left. Rt.
 — Strong
 — Flint
 — Magnolia
 — Cottage
 — Seward
 — Plymouth av.

Genesee Avenue, from 303 North St. Paul, near north boundary, to stbt. landing; ward 5

George, from 45 Chestnut, east, to 42 South Union; wards 4, 7

Left. Rt.
 1 2 Chestnut
 — 8 Jersey
 — William
 — Manhattan
 — Savannah
 — South Union

George's Park, from 28 Clifton, south; ward 8

German, from 51 North avenue, east, to Hebard; wards 10, 14

Left. Rt.
 — North avenue
 — Philander
 — Scio
 — Hebard

German Alley, changed to Sigel

Gibbs, from 42 East avenue, north, to Tappan; wards 10, 14

Left. Rt.
 — East avenue
 — Main
 — Grove
 27 28 Selden
 41 University av.
 — Delevan
 — Tappan

Gibbs Alley, from Gibbs; ward 14

Gilmore, from Hudson, west, to Henry; wd. 14

Glasgow, from Genesee river, west, to 117 Caledonia avenue; ward 3

Left. Rt.
 — Exchange
 — Plymouth av.
 — Caledonia av.

Glenwood Avenue, continuation of Brisbane, from First, west, to Fourth; ward 9

Gold, from Mt. Hope av. near Elmwood avenue, east, to South av.; wd. 16

Goodman, from Norton, south-east, to south line of city; wds. 10, 7, 12, 16

Left. Rt.
 — Norton
 — Bay
 — Central Park
 — Pennsylvania av.
 — Main
 — N. Y. C. R. R.
 — College Avenue
 — Anderson ave.
 — University av.
 — East avenue
 — Park avenue
 — Brighton avenue
 — Pearl
 — Harard
 — Monroe avenue
 — Erie canal
 — Pinnacle avenue
 — Caroline
 — Oakland

Gorham, from 144 North St. Paul, east, to 192 North Clinton; ward 5
Left. Rt.
 2 1 North St. Paul
 8 Martin
 — Almira
 36 Cole
 46 51 North Clinton

Graham, changed to Saratoga avenue; wd. 9

Grand, from 103 South avenue, east, to 114 Pinnacle avenue; ward 12
Left. Rt.
 — South avenue
 — Whalin
 — Viele
 31 Bond
 41 42 Pinnacle avenue

Granger, from 86 North Clinton, west, to 56 North St. Paul; ward 5

Grace, from 202 North, east, to Concord avenue; ward 14

Grape, from 8 Wilder, north, to Magne; wd. 11
Left. Rt.
 1 2 Wilder
 — Romeyn
 11 Campbell
 16 Clark
 27 26 Orange
 — Jay
 — Smith
 — Magne

Graves, from 5 Buffalo, to Millrace; ward 1

Green, from 2 Monroe avenue, south, to 29 Griffith; wards 4, 7
Left. Rt.
 — Jackson
 13 14 Howell
 — Marshall
 — Griffith

Green Alley, from Jay, north, to Smith; ward 9

Greenman Avenue, fr. Clifford, near Conkey av., north; ward 5

Greenwood Avenue, fr. 35 Troup, south, to 20 Atkinson; ward 3

Gregory, from 119 Mt. Hope avenue, east, to 100 South av.; ward 12
Left. Rt.
 1 2 Mt. Hope av.
 — Poplar
 33 34 Ashland
 69 76 South avenue

Greig Place, fr. 132 Plymouth av. south, to Clarissa; ward 3
Left. Rt.
 — Plymouth av.
 — Hubbell park
 — Clarissa

Griffith, from 164 South St. Paul, east, to 76 Monroe avenue; ward 7
Left. Rt.
 1 2 South St. Paul
 19 South
 29 26 Green
 45 48 Broadway
 60 Pearl
 — South Union
 — Monroe

Grove, from 34 North, east, to Gibbs; ward 14
Left. Rt.
 1 2 North
 15 16 Stillson
 21 Gibbs

Hague, from West ave. north, to West Maple; ward 15

Hamburgh, from 45 St. Joseph, east, to 57 Chatham; ward 6
Left. Rt.
 — St. Joseph
 — Chatham

Hamilton Place, from 67 Mt. Hope av. east, to 78 Pinnacle av.; ward 12
Left. Rt.
 1 2 Mt. Hope avenue
 41 44 South avenue
 65 Van
 71 70 Bond
 70 Pinnacle avenue

Hand, from 128 North St. Paul, east, to 170 North Clinton; ward 5
Left. Rt.
 — North St. Paul
 — Shamrock
 — Emmet
 — North Clinton

Hanover, from 61 Kelly, north, to 36 Baden; ward 13

Harris Avenue, fr. Clifford, north, to Tower; ward 5

Harrison, from 37 Hudson, west, to 66 Chatham; ward 6
Left. Rt.
 — Hudson
 — Oregon
 — Leopold
 — Chatham

Hart Avenue, from 228 North St. Paul, east, to Galusha; ward 5
Left. Rt.
 — North St. Paul
 — Martin
 — Galusha

Harvard, from Meigs, east, to Goodman; wd. 7
Left. Rt.
 — Meigs
 — Rowley
 — Goodman

Harvest, from Bay, north and south; ward 16

Hastings, from Perkins, north, to McCracken; ward 9
Left. Rt.
 — Perkins
 — Champion
 — Brisbane
 — Rowe
 — McCracken

Hawkins, from 30 Scrantom, south, to Oakman; ward 5

Hawthorn, from East av. northerly, to Culver place; ward 16

Hayward Park, from St. Joseph near Clifford, west; ward 16

Hebard, fr. Davis, north, to Bay, forming part of boundary; ward 10

Left. Rt.
 — Davis
 — Huron
 — German
 — Bay

Helena, from Hudson, east, to Concord avenue
Left. Rt.
 — Hudson
 — Putnam
 — Frederick
 — North
 — Concord avenue

Henion Place, from 163 West avenue, south, to Clifton; ward 8

Henrietta Avenue, from 225 Pinnacle av., at city line; ward 12

Henry, from 39 Herman, north, to City line; ward 13

Herman, from 132 St. Joseph, east, to Hudson; ward 13
Left. Rt.
 — St. Joseph
 — Hanover
 — Thomas
 — Hudson

Hickory, from 97 Mt. Hope avenue, east, to 88 South avenue; wd. 12
Left. Rt.
 — Mt. Hope avenue
 31 32 Ashland
 — 90 South avenue

High, from Ulm, east; ward 16

Hill, from 7 Elizabeth, west, to Broad; ward 1
Left. Rt.
 — Elizabeth
 — North Ford
 — Broad

Hoelfer, from 287 North Clinton, east, to St. Joseph; ward 13

Hoeltzer, from 271 North Clinton, east, to 167 St. Joseph; ward 13

Holland, from 56 St. Joseph, east, to 47 Hudson, south; ward 6
Left. Rt.
 — St. Joseph
 — Chatham
 — Hudson

Hollenbeck, from Norton, to boundary; wd. 5

Holley, changed to Pinnacle avenue

Hollister, fr. Channing, opposite Concord avenue, north, to City line; ward 14

Hope, from Hanover, east, to 73 Hudson

Howell, from 144 South St. Paul, east, to 50 Monroe av.; wds. 4, 7
Left. Rt.
 1 2 South St. Paul
 13 14 South
 23 24 Green
 36 Broadway
 39 William
 47 52 Monroe avenue

Hoyt, from Ulm, south; ward 16

Hubbell Park, from 224 Exchange, west, to Greig place; ward 3

Hudson, from 107 North, north, to city line; wards 6, 13
Left. Rt.
 1 2 North
 37 Harrison
 47 Holland
 53 Nassau
 66 Webster
 69 Kelly
 78 Woodbury
 73 Hope
 — Baden
 — Wilson
 — Vienna
 — Helena
 — Rhine
 — Herman
 — Foechner
 — Channing
 — Gilmore
 — Vose
 — Weeger
 — Clifford
 — Norton (city line)

Hume, fr. Genesee, west; ward 8

Hunter, from 110 Caledonia avenue, west, to boundary; wards 3, 8
Left. Rt.
 — Caledonia av.
 — Gen. Val. canal
 — Olean
 — Seward
 — May
 — Reynolds
 — Frances
 — Summer
 — Genesee
 — South York

Hunter's Alley, from 27 Elizabeth, west, to 16 North Ford; ward 1

Huntington, from Hudson, east; ward 13

Huron, from 177 Scio, east, to Hebard; wd. 10

Irondequoit, from North avenue, south; ward 16

Irving Place, from 69 W Main, south, to Erie canal; ward 1

Jackson, from 120 South St. Paul, east, to 14 Monroe avenue; ward 4
Left. Rt.
 1 2 South St. Paul
 15 14 South
 — Green
 — Monroe avenue

James, from 17 Chestnut, east, to 20 William; ward 4
 ward 15

Jay, from 293 State, west, to city line; wards 2, 9, 11, 16
Left. Rt.
 2 1 State
 10 11 Brown's alley
 19 20 Frank
 29 28 Jones
 36 Bollivar
 47 46 Kent
 57 56 Oak
 69 86 Charles
 69 — Magne
 85 — Grape
 103 106 Walnut
 117 118 Saxton
 135 136 Orchard
 — — Whitney
 — — Childs

Jefferson Park, from Alexander, south, to Hamilton place; ward 12
Jennings, from North av. east, to Goodman; ward 16
Jersey, from 8 George, south; ward 7
John, from 36 Allen, north, to 43 Platt; wd. 2
Left. Rt.
 — — Allen
 — — Centre
 — — Dean
 — — Platt
Johnson Park, from 31 Stone, east, to 30 South Clinton; ward 4
Joiner, from 39 Atwater, north, to 12 Kelly; wards 6, 13
Left. Rt.
 — — Atwater
 — — 68 Nassau
 — — 82 Kelly
Jones, from 44 Centre, north, to Lyell; wds. 2, 9
Left. Rt.
 1 2 Centre
 15 14 Dean
 29 30 Platt
 52 Brown
 72 Jay
 — — Smith
 — — Lyell
Jones Avenue, from 51 Lake avenue, west, to Erie canal; ward 9
Left. Rt.
 — — Lake avenue
 — — Fulton avenue
 — — Frank
 — — Saratoga avenue
 — — Thompson
 — — Durkin alley
 — — West
 — — Erie canal
Jones Square, bounded by Jones avenue, Saratoga avenue, Lorimer, and Frank; ward 9
Joslyn Park, from 75 Scio, east, to North Union; ward 10
Julia, from 57 West avenue, south, to 157 Atkinson; ward 8
Left. Rt.
 — — West avenue
 — — Troup
 — — Atkinson
Keeler, from Laburnam, north-east, to Monroe av. near canal; ward 16
Kelly, from 183 North Clinton, east, to 69 Hudson; ward 13
Left. Rt.
 1 2 North Clinton
 12 Joiner
 37 36 St. Joseph
 — — Chatham
 61 Hanover
 103 102 Hudson
Kent, from 42 Allen, north-west, to opposite 46 Jay; ward 2
Left. Rt.
 2 1 Allen
 18 21 Dean
 32 33 Platt
 46 Eric
 64 63 Brown

Left. Rt.
 88 87 Jay
Kent Alley, from 46 Jay, north, to Lind; ward 9
King, from 100 West av. north, to 201 Brown; ward 8
Left. Rt.
 — — West avenue
 — — Madison square
 — — East Maple
 — — N. Y. C. R. R.
 — — Allen
 — — Brown
Klinck, from Monroe av. north, to Erie canal; ward 16
Kirk, from 126 North, east, to 112 Scio; wd. 14
Left. Rt.
 1 2 North
 27 20 Finney
 61 68 Scio
Kondolf, from Whitney, west, to Childs, between Smith and Jay; ward 11
Lafayette, changed to Adams
Laburnam, from Monroe avenue, north, to Erie canal; ward 16
Laforce Park, from 305 N. Clinton, east; wd. 16
Lake Avenue, a continuation of State, north from Lyell and Vincent place, to City line; wd. 9
Left. Rt.
 1 — Lyell
 2 — Vincent place
 21 — 30 White
 41 44 Spencer
 49 50 Ambrose
 51 — Jones avenue
 71 — Lorimer
 93 — Phelps avenue
 115 — Emerson
 125 124 Perkins
 135 136 Champion
 141 142 Brisbane
 151 152 Rowe
 — — McCracken
 — — Lake View park
 — — Ridge road
 — — Little Ridge road
Lake View Park, from Lake avenue, near City line, west; ward 9
Lamberton Park, from 161 West av. south, to West Troup; ward 8
Lancaster, fr. 144 Main, south, to 21 Monroe av. ward 4
Left. Rt.
 — — Main
 — — Court
 — — Monroe avenue
Landing, from North, near City line, to North avenue; ward 14
Langham, fr. St. Joseph, n. Clifford, west; wd. 16
Lansing, from Hollister, west; ward 14
Lauer, from North ave. east; ward 14
Lawrence, from 112 East avenue, north, to 46 Charlotte; ward 10

Leavenworth Alley, fr. Perkins, north, to Brisbane; ward 9
Leighton Avenue, from Goodman, east, to Culver; ward 16
Leopold, from 77 Atwater, north, to Harrison; ward 6
Lewis, from Davis, east, to 131 N. Union; ward 14
Lewis, from Mount Vernon avenue, east to city line; ward 12
Liberty, from 43 Main, n., to Mortimer; wd. 5
Lime, from 5 Saxton, west, to Childs; ward 11
Left. Rt.
 — — Saxton
 — — Orchard
 — — Whitney
 — — Childs
Lincoln, from Channing, north, to City line; ward 14
Lind, from 77 Bolivar, north, to Oak; ward 9
Linden, from Mt. Hope avenue, east, to South avenue; ward 12
Litchfield, from 86 West avenue, north, to 61 Brown; ward 8
Left. Rt.
 — — West avenue
 — — 37 38 Maple
 — — N. Y. C. R. R.
 100 99 Allen
 — — Brown
Little Ridge Road, from Lake ave. north-west; ward 15
Livingston, from North St. Paul, opposite Gorham, west, to Genesee river; ward 5
Livingston Place, from 41 Spring, to 42 Troup; ward 3
Locust, from Varnum near Perkins; ward 9
Lorimer, from 71 Lake avenue, west, to West; ward 9
Left. Rt.
 — — Lake avenue
 — — Fulton avenue
 — — Frank
 — — Jones square
 — — Saratoga avenue
 — — Thompson
 — — West
Lorimer Place, fr. Lorimer, north; ward 9
Lowell, from 178 North St. Paul, east, to 223 North Clinton; ward 5
Left. Rt.
 1 2 North St. Paul
 7 8 Martin
 21 Galusha
 37 38 Almira
 60 Cole
 75 74 North Clinton
Lundy's Lane, from 53 Atwater, east, to N. Y. C. R. R.; ward 6
Lyell, from 349 State, west, to boundary; wards 9, 11
Left. Rt.
 1 2 State
 15 — Brown's alley

Left. Rt.
 29 28 Frank
 39 Jones
 55 Bolivar
 56 Spencer
 56 Saratoga avenue
 77 Oak
 78 Thompson
 81 Moore
 84 Durkin alley
 89 Saxton
 90 West
 — — Erie canal
 — — Magne
 — — Orchard
 — — Sherman
 — — Whitney
 — — Childs
 — — Cameron
 — — City line
Madison, from 114 West avenue, north, to East Maple; ward 8
Left. Rt.
 2 West avenue
 — — Madison square
 43 42 East Maple *
Madison Park, from King, west, to Madison; ward 8
Magne, from 60 Brown, north, to Lyell; ward 11
Left. Rt.
 1 2 Brown
 9 10 Romeyn
 13 Orange
 21 24 Jay
 43 Smith
 — — Grape
 — — Walnut
 — — Saxton
 — — N. Y. C. R. R.
 — — Lyell
Magnolia, fr. Genesee, east, to Seward; ward 8
Left. Rt.
 — — Genesee
 — — Frances
 — — Seward
Main, see East Main, or West Main
Manhattan, fr. 78 Court, south, to 59 Monroe av; ward 7
Left. Rt.
 1 2 Court
 35 24 George
 89 74 Monroe avenue
Mansion, from Magnolia north, to G. V. canal; ward 8
Left. Rt.
 — — Magnolia
 — — Flint
 — — Gen. Val. canal
Maple, see East Maple or West Maple
Maple Place, from 192 Monroe avenue; wd. 7
Maria, from Clifford, near St. Joseph, south; ward 13
Marietta, from 82 North St. Paul, east, to 110 North Clinton; ward 5
Left. Rt.
 — — North St. Paul
 — — Pitt
 — — North Clinton
Marion, from Reynolds, near Tremont, west, to Frances, near Penn; ward 8

Mark, from 140 Hudson, east, to North; ward 13
Market, from 58 State, east, to 58 Front; wd. 1
Left. Rt.
 2 1 State
 8 9 Mill
 24 21 Front
Marshall, fr. 154 South St. Paul, east, to 72 Monroe avenue; ward 7
Left. Rt.
 1 2 South St. Paul
 11 12 South
 25 22 Green
 — Broadway
 47 56 Monroe avenue
Martin, from 8 Gorham, north, to Hart avenue; ward 5
Left. Rt.
 — Gorham
 — Lowell
 — Hart avenue
Mary, fr. Clifford north; ward 16
Mason, from Thorn, west, to Third; ward 9
Mathews, from 64 East av., north, to 4 Charlotte; ward 10
Mauder's Park, from Oakman; ward 5
McCracken, from Buell avenue, west, to city line; wards 9, 15
McDonald Avenue, fr. 199 North Clinton, east, to 105 St. Joseph; wd. 13
McLean, from Genesee, west; ward 8
Mechanics' Square, changed to Madison square
Meigs, from 261 East avenue, south, to city line; wards 7, 12
Left. Rt.
 1 2 East avenue
 37 38 Park avenue
 — 42 Tracy Park
 — Brighton avenue
 — Harvard
 — Monroe avenue
 — Pearl
 — Broadway
 — Erie canal
 — Pinnacle avenue
 Caroline
Michael, from N. Clinton n. Scramton, west; wd 5
Michigan, fr. Erie canal, west, to city line; wd. 15
Mill, from 12 Exchange place, north, to Brown; wards 1, 2
Left. Rt.
 25 26 Market
 67 62 Mumford
 91 Railroad avenue
 97 96 N. Y. C. R. R.
 103 100 Centre
 117 116 Furnace
 131 138 Platt
 149 Factory
 — Brown
Miller, from Bay, north, to Jennings; ward 16
Miller's Alley, from 31 Atwater, east, to N. Y. C. R. R.; ward 6
Milo, from 58 North avenue, west, to Concord avenue; ward 14

Minerva Place, from 76 Main, south, to 4 Ely; ward 4
Monroe Avenue, from 59 South Clinton, south, east, to City line; wards 4, 7
Left. Rt.
 2 Green
 21 14 Lancaster
 39 Chestnut
 49 42 William
 50 Howell
 67 Manhattan
 87 Savannah
 70 Marshall
 105 86 South Union
 86 Griffith
 143 134 Alexander
 164 Averell
 193 178 Meigs
 192 Maple Place
 215 Rowley
 208 Edmonds
 241 242 Goodman
 — Boardman
 — Wilcox
 — Nichols Park
 — Bowen
 — Erie canal
 — Culver (city line)
Montgomery Alley, fr. Erie canal, north, to 6 Centre; wards 1, 2
Montrose, from Saratoga av., east, to Frank; wd. 9
Moore, from 81 Lyell, south, to Erie canal; ward 9
Moore's Alley, from 15 Elizabeth, west, to 8 North Ford; ward 2
Morgan, from Clifton, south, to Tremont; wd. 8
Morris, from 217 North Clinton, east, to St. Joseph; ward 13
Mortimer, from 20 North Clinton, west, to 33 North Water; ward 5
Left. Rt.
 — North Clinton
 — North St. Paul
 — North Water
Moulson, fr. Jay, north, to Lyell; ward 15
Mt. Hope Avenue, from South St. Paul street bridge, south, to City line; ward 12
Left. Rt.
 1 2 Erie canal
 7 Holley
 33 Comfort
 55 Alexander
 67 Jefferson
 83 Mungier
 97 Hickory
 109 110 Gregory
 — Clarissa
 127 Cypress
 — Linden
 — Mt. Hope Cem'y
 — Elmwood
Mt. Vernon Avenue, from Lewis to south, Cayuga place; wd. 12
Mumford, from 102 State, east, to Andrews street bridge; wards 1, 2
Left. Rt.
 1 2 State

Left. Rt.
 11 14 Mill
 27 26 Front
Munger, fr. 83 Mt. Hope avenue, east, to #2 Pinnacle avenue; ward 12
Left. Rt.
 1 2 Mt. Hope avenue
 15 18 Ashland
 41 44 South avenue
 — Whalin
 — 74 Bond
 — 88 Pinnacle avenue
 — Erie canal
Murray, from Jay, north, to Lyell; ward 16
Myrtle, fr. Lyell, north, to Otis; ward 15
Nassau, from 68 Joiner, east, to 58 Hudson; wards 6, 13
Left. Rt.
 1 2 Joiner
 17 16 St. Joseph
 29 28 Chatham
 73 70 Hudson
Nelson, changed to Meigs
New Main, see East Main
New York, from North Frances, west, to Wentworth; ward 8
Nichols, from Jennings, north and south; wd. 16
Nichols Park, from Monroe av. beyond Goodman, north-east, to Wilder place; wd. 16
Ninth, from Rowe, south, to Erie canal; ward 15
North, fr. 160 North ave. north-east, to City line; wards 13, 14
 162 North avenue
 173 Webster
 — Concord avenue
 181 Woodbury
 189 Wilson
 201 Helena
 202 Grace
 216 Draper
 — Foehner
 — Channing
North Avenue, from 155 E. Mam, north-east, to City line; wds. 6, 14, 16
Left. Rt.
 1 2 Main
 4 Franklin
 11 16 Achilles
 41 Amity
 34 Grove
 49 Andrews
 62 University av.
 75 Clinton place
 82 Delevan
 103 Atwater
 Tappan
 Hudson.
 107
 112 Weld
 126 Kirk
 144 Ontario
 144 Davis
 158 Tyler
 — N. Y. C. R. R.
 — North
 35 Syracuse
 51 German
 — Milo
 58 — Bay
 — Channing
 — Landing
 — Norton

North Clinton, from 127 Main, north, to City line; wards 5, 6, 13
Left. Rt.
 2 1 Main
 12 Division
 20 Mortimer
 34 Pleasant
 42 45 Franklin
 50 49 Andrews
 77 Clinton place
 86 Granger
 94 101 Atwater
 110 Marietta
 126 Ward
 170 Hand
 183 Kelly
 192 Gorham
 199 McDonald av.
 207 Catharine
 217 Morris
 229 Buchan park
 228 Lowell
 237 Elizabeth place
 240 Oakman
 249 Sellinger
 259 Rauber
 271 Hoeltzer
 272 Scramton
 300 299 Clifford
 — Norton (city line)
North Ford, fr. 20 West avenue, north, to 55 Allen; wards 1, 2
Left. Rt.
 — West avenue
 — Erie canal
 5 Hill
 8 Moore alley
 — N. Y. C. R. R.
 16 Hunter's alley
 19 22 Allen
North Frances, from 120 West avenue, north, to 247 Brown; ward 8
Left. Rt.
 — West avenue
 9 New York
 23 Terry
 49 50 East Maple
 — Brown
North Stillson, from 19 Weld, to Kirk; ward 14
North St. Paul, from 57 Main, north, to City line; ward 5
Left. Rt.
 1 2 Main
 19 18 Mortimer
 26 Pleasant
 33 36 Andrews
 53 River
 54 Franklin
 56 Granger
 65 64 Atwater
 82 Marietta
 96 Ward
 128 Hand
 144 Gorham
 — Livingston
 — Vincent Place
 178 Lowell
 228 Hart avenue
 264 Scramton
 — Evergreen
 288 Clifford
 — Avenue A
 — Avenue B
 — Avenue C
 — Avenue D
 — Avenue E
 — Parkland
 — Norton
 Ridge road

North Union, from 100 East avenue, north-east to City line; ward 10
Left. Rt.
 1 2 East avenue
 15 Vine
 31 30 Charlotte
 -7 44 Asylum
 5 56 University av.
 — Main
 .5 Joslyn park
 — Tappan
 — Weld
 — Ontario
 — N. Y. C. R. R.
 131 132 Lewis

North Washington, fr. 176 West Main, north, to 23 Allen; ward 1

North Water, from 39 Main, north, to 1 Atwater; ward 5
Left. Rt.
 2 1 Main
 — 33 Mortimer
 98 97 Andrews
 144 143 River
 160 159 Atwater
 162 161 N. Y. C. R. R.

North York, from 184 West avenue, north, to West Maple; ward 11

Norton, from North St. Paul, east, to City line; ward 5
Left. Rt.
 — North St. Paul
 — Parkland
 — Hollenbeck
 — North Clinton
 — St. Joseph
 — Hudson
 — Carter
 — North Avenue
 — Goodman

Oak, fr. 56 Allen, north, to 77 Lyell; wards 2, 9
Left. Rt.
 2 Allen
 4 Dean
 21 20 Platt
 33 32 Erie
 49 50 Brown
 80 Jay
 118 Smith
 — N. Y. C. R. R.
 — Lind
 — Lyell

Oakland, fr. South avenue, east, to Goodman; ward 12
Left. Rt.
 — South avenue
 — Mt. Vernon av.
 — Nelson
 — Goodman

Oakland Park, from Caroline, south to Oakland; ward 12

Oakman, from Galusha, east, to 240 North Clinton; ward 5
Left. Rt.
 — Galusha
 — Hawkins
 — North Clinton

Olean, fr. Frost avenue, north, to Hunter; wd 8
Left. Rt.
 — Frost avenue
 — Champlain
 — Cady
 — Hunter

Olive, from near Davis, east, to Union; wd. 14

Ontario, from 144 North, east, to Alexander; wards 14, 10
Left. Rt.
 — North
 22 23 Finney
 58 59 Scio
 — North Union
 — Alexander

Orange, from Magne, west, to Childs; ward 11
Left. Rt.
 — Magne
 — Grape
 — Walnut
 — Saxton
 — Orchard
 — Whitney
 — Childs

Orchard, from 50 West Maple, north, to Lyell; ward 11
Left. Rt.
 — West Maple
 — Wilder
 — Campbell
 — Orange
 — Jay
 — Smith
 — Lime
 — N. Y. C. R. R.
 — Lyell

Oregon, from 89 Atwater, north, to Harrison; ward 6

Otis, fr. Sherman, west, to city line; ward 15

Otsego, from 22 Centre, north, to 25 Platt; wd. 2

Paddy Lane, see Field

Park Avenue, from 122 Alexander, east, to Vick park; ward 7
 — Alexander
 — Meigs
 — Goodman
 — Wilder Place
 — Vick Park

Park Place, fr. 53 West ave. south, to Troup; ward 8

Parkland, from Beach, near City line, to Norton; ward 5

Peach Alley, from Garden, south, to Atkinson; ward 3

Pear Alley, from Garden, east, to 46 Atkinson; ward 3

Pearl, from 60 Griffith, east, to Meigs; ward 7
Left. Rt.
 1 2 Griffith
 17 South Union
 43 46 Alexander
 57 66 Averell
 93 94 Meigs

Penn, from Frances, near Tremont, west, to Summer; ward 8
Left. Rt.
 — St. Clair
 — Morgan
 — Saxe

Penney's Alley, from Scio, east, to Mathews; ward 10

Pennsylvania Avenue, from North Union east to Goodman, ward 16

Perkins, from Burns, to Deep Hollow; ward 9

Phelps Avenue, from 95 Lake avenue, west, to House of Refuge; wd. 9

Philander, from Syracuse, north, to German; ward 13

Phillips Alley, from 46 South Clinton, west, to 43 Stone; ward 4

Pindell Alley, from 70 W. Main, north, to 4 Allen; ward 1

Pine, fr. 5 Troup, north, to Erie canal; ward 3
Left. Rt.
 — Troup
 — Spring

Pinnacle Avenue, from 7 Mt. Hope av., south-east to City line; wd. 12
Left. Rt.
 1 2 Mt. Hope avenue
 — 48 Comfort
 89 72 Alexander
 — 78 Hamilton place
 — 92 Munger
 — Averell
 — 114 Grand
 171 172 Meigs
 225 Henrietta av.
 — City line

Pitt, from 11 Atwater, north, to Marietta; wd. 5

Platt, from Brown's race, west, to Warehouse; ward 2
Left. Rt.
 — Mill
 — State
 25 Otsego
 33 34 Frank
 39 40 Jones
 43 John
 — N. Y. C. R. R.
 51 Kent
 63 64 Oak
 — Warehouse

Pleasant, from 26 North St. Paul, east, to 34 North Clinton; ward 5

Plum Alley, from Ford east, to Eagle; ward 3

Plymouth Avenue, fr. 131 W. Main, south-west, to Genesee; wds. 1, 3, 8
Left. Rt.
 2 1 Buffalo
 — Erie canal
 32 35 Spring
 52 59 Troup
 — 71 Atkinson
 86 87 Adams
 — 107 Tremont
 126 123 Edinburgh
 130 129 Glasgow
 132 Greig place
 154 Summer alley
 166 Clarissa
 — 165 Caledonia av.
 — Gen. Val. canal
 — 173 Frost avenue
 179 Bartlett
 207 Strong
 — Flint
 — Magnolia
 — Cottage
 — Genesee

Pomeroy, from N. Y. C. R. R. north; ward 15

Poplar, from 20 Gregory, south, to Linden; wd. 12

Prince, from 224 East avenue, north-east, to Main; ward 10
Left. Rt.
 — East avenue
 — University av.
 — College Avenue
 — Main

Prospect, from 71 West avenue, south, to 107 Adams; ward 8
Left. Rt.
 — West avenue
 — Troup
 — Clifton
 — Atkinson
 — Adams

Putnam, from Helena, north, to Foechner; ward 13

Pryor, from St. Joseph, east, to Hanover; wd. 13

Race, from Aqueduct, east, to Graves; ward 1

Railroad Avenue, from 150 State, east, to N. Y. C. R. R. Depot; ward 2

Railroad Alley, chang'd to Silver

Rauber, from 259 North Clinton, east, to St. Joseph; ward 13

Reynolds, from 115 West avenue, south, to Seward; ward 8
Left. Rt.
 — West avenue
 — Troup
 — Clifton
 — Atkinson
 — Adams
 — Tremont
 — Hunter
 — Cady
 — Champlain
 — Frost Avenue
 — Bartlett
 — Strong
 — Flint
 — Seward

Rhine, from 54 Hanover, east, to Hudson; wd. 13

Richard, from Boardman, north-east, to Wilcox; ward 16

Ridge Road, from Lake avenue, west, to City line; ward 15. (see also Little Ridge)

Ringelstein Alley, fr. 154 North Clinton; wd. 5

Ritter, fr. 149 Exchange, east, to Erie Railway; ward 3

River, from 53 North St. Paul, west, to the river; ward 5

Rohr, from Bay, north; ward 16

Rome, from 35 Clinton place, to 78 Atwater; ward 6

Romeyn, from Magne, west, to Wilder; wd. 11

Rowe, from Hastings, west, to City line; wd. 9
Left. Rt.
 — Hastings
 — Lake avenue
 — Thorn

Rowley, from Park av. south, to 215 Monroe avenue; ward 7

Sanford, from 121 Mt. Hope avenue, east, to 114 South av.; ward 12

Saratoga Avenue, from Lyell, north-west, to House of Refuge; wd. 9
Left. Rt.

— — Lyell
— — Spencer
— — Ambrose
— — Jones avenue
— — Lorimer
— — Montrose
— — Costar

Sauer's Park, from 40 Sanford, south; wd. 12

Savannah, fr. 90 Court, south, to 87 Monroe av.; ward 7
Left. Rt.

— — Court
— — George
— — Monroe avenue

Saxe, fr. Clifton, south, to Penn; ward 8

Saxton, from 89 Lyell, south, to 166 Brown; ward 11
Left. Rt.

— — Lyell
— — N. Y. C. R. R.
5 — — Lime
— — Smith
— — Jay
— — Orange
— — Campbell
— — Wilder
— — West Maple
— — N. Y. C. R. R.
— — Brown

Schanck Avenue, fr. intersection of Goodman and Webster road. east-ly, to Culver; wd. 16

School Alley, fr. Spring, south, to Troup; ward 3

Scio, from 54 East avenue, north, to German; wards 10, 14
Left. Rt.

2 — — 1 East avenue
— — 27 Charlotte
44 — — 43 Main
— — 45 Asylum
58 — — 55 University av.
68 — — Delevan
— — 75 Joslyn park
80 — — 81 Tappan
98 — — 99 Weld
112 — — Kirk
124 — — 125 Ontario
138 — — Lewis
150 — — Davis
156 — — 157 Tyler
— — N. Y. C. R. R.
160 — — Syracuse
— — 177 Huron
208 — — 209 German

Scott Alley, from 144 West Main, north, to 29 Allen; ward 1

Serantom, fr. 264 North St. Paul, east, to 273 North Clinton; ward 5
Left. Rt.

1 — — 2 North St. Paul
13 — — Conkey avenue
— — 30 Hawkins
— — North Clinton

Seager, fr. Lewis, south; ward 16

Second, from Glenwood avenue, north, to Rowe; ward 9

Second Avenue, fr. Pennsylvania ave. north, to Bay; ward 16

Selden, from opposite 27 Gibbs, east, to opposite 35 Cherry; ward 14

Sellinger, fr. 249 North Clinton, east, to 147 St. Joseph; ward 13

Seventh Avenue, from Goodman, north, to Bay; ward 16

Seward, fr. Cady, south, to Genesee; ward 8
Left. Rt.

— — Cady
— — Champlain
36 — — Frost Avenue
— — Bartlett
— — Strong
— — Flint
— — Reynolds
— — Magnolia
— — Frances
— — Cottage
— — Genesee

Shamrock, from Ward, north, to Hand; ward 5

Sheridan Park, from 27 Martin, to Almira; wd. 5

Sherman, from Lyell, west, to Deep Hollow; ward 11

Sherman Place, fr. Sherman, east, to Erie canal; Ward 9

Sibley, from East avenue, south and east, to Culver; ward 16

Sigel, fr. German, north, to Bay; wds. 10, 14

Silver, fr. West Maple, west, to North York; ward 11

Sixth Avenue, fr. Pennsylvania ave. north, to Bay; ward 16

Smith, fr. 345 State, west, to Childs; wards 9, 11
Left. Rt.

1 — — 2 State
— — Brown's alley
15 — — 18 Frank
— — Jones
31 — — 36 Bolivar
— — N. Y. C. R. R.
— — 46 Kent alley
51 — — 52 Oak
— — Erie canal
— — Magne
— — Grape
— — Walnut
— — Saxton
— — Orchard
— — Whitney
— — Childs

Sophia, from 134 West Main, north, to 35 Centre; wards 1, 2
Left. Rt.

1 — — 2 West Main
45 — — 62 Allen
— — N. Y. C. R. R.
— — 66 Centre

South, from 30 Court, south, to 19 Griffith; wards 4, 7
Left. Rt.

2 — — 1 Court
— — Washington sq.
20 — — 21 Jackson
36 — — 37 Howell
44 — — 43 Marshall
— — Griffith

South Avenue, fr. South St. Paul street bridge, south, to City line; ward 12
Left. Rt.

1 — — 2 Mt. Hope avenue
7 — — Pinnacle avenue
— — Comfort
49 — — 50 Alexander
63 — — 64 Hamilton place
75 — — 76 Mungy
— — 88 Hickory
100 — — 100 Gregory
103 — — Grand
— — 114 Sanford
117 — — Caroline
— — Cypress
— — Linden
— — Oakland
— — Elmwood

South Clinton, from 116 Main, south, to 1 Monroe avenue; ward 4
Left. Rt.

1 — — 2 Main
— — 8 Allen's alley
30 — — Johnson park
39 — — 42 Court
59 — — Washington sq.
59 — — 60 Monroe avenue

South Ford, fr. 19 West avenue, south, to Erie canal; ward 3
Left. Rt.

— — West avenue
32 — — Spring
42 — — 49 Troup
— — Waverly place
— — Atkinson
— — Adams

South St. Paul, from 54 Main, south, to Erie canal; wards 4, 7
Left. Rt.

2 — — 1 Main
34 — — Ely
72 — — 75 Court
126 — — Jackson
144 — — Howell
154 — — Marshall
164 — — Griffith

South Union, from 101 East avenue, south, to 19 Pearl; ward 7
Left. Rt.

— — East avenue
— — Cotrnt
17 — — Gardner park
— — 42 George
81 — — 78 Monroe avenue
— — 80 Griffith
— — Pearl

South Washington, fr. 169 West Main, south, to 14 Atkinson; wards 1, 3
Left. Rt.

— — West Main
— — Erie canal
— — Spring
— — Troup
— — Atkinson

South Water, from 36 Main, south, to Erie canal; ward 4

South York, changed to Briggs' place

Spencer, from 56 Lyell, east, to the river; wd. 9
Left. Rt.

1 — — 2 Lyell
— — Frank
— — Lake avenue
— — Cliff

Sperry, from Genesee, east, to Cottage; wd. 8

Spring, fr. 60 Exchange, west, to S. Ford; ward 3
Left. Rt.

1 — — 2 Exchange
— — Pine alley
13 — — 14 Fitzhugh
25 — — 24 Plymouth av.
— — 28 Spring alley
33 — — 32 S. Washington
37 — — 36 West alley
41 — — Livingston place
49 — — 50 Caledonia av.
54 — — 55 Favor
60 — — 61 South Ford

Spring Alley, from 139 W. Main south to Troup; ward 3
Left. Rt.

— — West Main
— — Spring
— — Troup

Stanley, from Mt. Hope avenue, east, to city line; ward 16

State, from 40 West Main north, to 1 Lyell; wards 1, 2, 9
Left. Rt.

1 — — 2 West Main
— — 22 Exchange place
— — 58 Market
— — 102 Mumford
137 — — Allen
— — 150 Railroad avenue
— — N. Y. C. R. R.
155 — — 160 Centre
— — 186 Furnace
195 — — 208 Platt
209 — — Vought
— — 228 Factory
255 — — 256 Brown
293 — — Jay
345 — — Smith
— — 346 Vincent place
349 — — Lyell
351 — — 350 Lake avenue

St. Clair, from Clifton near S. Frances, south, to Tremont; ward 8

Stephens' Park, from 95 St. Joseph; ward 13

Stettheimer Park, from East aveque near Goodman; ward 10

Stevens, from North av. west; ward 14

Stewart, from North av. west; ward 16

Stevens' Alley, fr. West av. south, to Spring; ward 3

Stillson, from 10 East av. north, to 18 University avenue; wards 10, 14; (see also North Stillson)
Left. Rt.

2 — — 1 East avenue
6 — — 5 Main
— — Achilles
14 — — 15 Grove
42 — — 41 University av.

St. James Park, from 38 Sherman, east, to Erie canal; ward 11

St. Joseph, from 11 Clinton place, north, to City line; wards 6, 13
Left. Rt.

1 — — 2 Clinton place
19 — — 10 Atwater
— — N. Y. C. R. R.
45 — — 44 Hamburg
— — Holland

Left. Rt.
 67 68 Nassau
 85 84 Kelly
 95 Stepheny's park
 — 106 Baden
 105 McDonald av.
 101 Catharine
 — 114 Vienna
 — Buchan park
 — 132 Herman
 147 Sellinger
 167 Hoeltzer
 201 200 Clifford
 — Norton
Stone, fr. 94 Main, south,
 to 19 Court; ward 4
Left. Rt.
 7 Allen's alley
 14 Ely
 31 Johnson park
 — Court
St. Paul, see N. St.
 Paul or South St Paul
Straub Alley, fr. Rowe,
 to Lake View; ward 9
Strong, from 207 Plym-
 outh avenue, west, to
 Genesee; ward 8
Left. Rt.
 — Plymouth av.
 — Seward
 — Reynolds
 — Frances
 — Genesee
Summer, from Clifton,
 south, to Hunter; wd. 8
Summer Alley, from 139
 Caledonia av. south, to
 Clarissa; ward 3
Summer Park, fr. Mon-
 roe ave. beyond Good-
 man, south; ward 16
Swan, from 48 East ave-
 nue, north, to 206 Main;
 ward 10
Swinerton, fr. Jennings,
 north; ward 16
Sycamore, from 3 Elm,
 east, to 2 Chestnut; wd. 4
Left. Rt.
 1 2 Elm
 6 Cedar
 — Chestnut
Syke, from Childs, west;
 ward 15
Syracuse, from 35 North
 avenue, east, to 160 Scio;
 ward 14
Tappan, from 98 North,
 east, to North Union;
 wards 14, 10
Left. Rt.
 2 1 North
 25 Gibbs
 68 63 Scio
 — North Union
Temple, from 22 Chest-
 nut, west, to 41 Lanca-
 ster; ward 4
Terry, from 23 North
 Frances, west, to 293
 Brown; ward 8
Third, from Glenwood
 avenue, north to Rowe;
 ward 9
Third Avenue, fr. Penn-
 sylvania av. north to
 Bay; ward 16
Thomas, from Herman,
 north, to Clifford; ward
 13

Thompson, fr. 78 Lyell,
 north, to House of Refu-
 ge; ward 9
Left. Rt.
 — Lyell
 — Jones avenue
 — Lorimer
 — Costar
Thompson Alley, from
 Frank, to Brown's al-
 ley; ward 2
Thompson Avenue, near
 Leighton av.; wd. 16
Thorn, fr. Rowe, north,
 to McCracken; ward 9
Thorn Alley, from 218
 Exchange, west; ward 3
Thrush, from Glenwood
 Park, north, to Mc-
 Cracken; ward 15
Thurston, fr. Chili road,
 south, to Rapids road;
 ward 15
Tonawanda, from 114
 Brown, west, to West
 Maple; ward 11
Tower, from North St.
 Paul, opposite McCrac-
 ken, east, to City line;
 ward 5
Tracy Park, from 42
 Meigs, to Alexander;
 ward 7
Tremont, from 107 Plym-
 outh avenue, west, to
 Saxe; wards 3, 8
Left. Rt.
 — Plymouth av.
 — Caledonia av.
 — Tremont Place
 — Gen. Val. canal
 — Reynolds
 — Frances
 — St. Clair
 — Morgan
 — Saxe
Tremont Place, from 45
 Tremont, south to Edin-
 burgh Court; wd. 3
Troup, from 114 Ex-
 change, west, to Fran-
 ces; wards 3, 8
Left. Rt.
 — Exchange
 — Pine alley
 — South Fitzhugh
 — Plymouth av.
 — Spring alley
 21 22 S. Washington
 32 West alley
 29 Greenwood alley
 — Eagle
 — Livingston place
 — Caledonia av.
 44 Favor
 51 52 South Ford
 — Trowbridge
 — Gen. Val. canal
 — Julia
 — Prospect
 — Reynolds
Trowbridge, from Erie
 canal, south, to Troup;
 ward 3
Left. Rt.
 — West avenue
 — Troup
Tyler, from 160 North,
 east, to Hebard; wards
 14, 10
Left. Rt.
 — North
 21 Finney
 — Scio
 — N. Y. C. R. R.
 — Hebard

Ulm, from Bay, north, to
 Jennings; ward 16
Union, see North Union,
 or South Union
Union Alley, from Clin-
 ton place, south, to An-
 drews; ward 6
Union Park, from So.
 Union near Monroe av.
 east; ward 7
Unity, from Grace, north,
 to Draper; ward 14
University Avenue, fr.
 62 North, east, to Cul-
 ver (city line); wards
 14, 10, 16
Left. Rt.
 1 2 North
 18 Stillson
 27 20 Gibbs
 54 Cherry
 71 70 Scio
 95 96 Main
 113 116 North Union
 143 142 Alexander
 — Prince
 — Goodman
 — Arlington
 — Delaware
Upton Park, from East
 avenue, north, to Uni-
 versity ave. ward 16
Van, from 50 Alexander,
 south, to Jefferson;
 ward 12
Varnum, changed to Ful-
 ton avenue
Vernon, fr. Bloss, west,
 to Saratoga av.; ward 9
Vernon Park, from 336
 N. Clinton, east; wd. 16
Vick Park, from East
 avenue, beyond city line
 southwest
Victoria, fr. rear Brown,
 near West av. west, to
 North York; ward 11
Vienna, from 114 St. Jo-
 seph, east, to Hudson;
 ward 13
Left. Rt.
 — St. Joseph
 — Hanover
 — Hudson
Villa Place, from Gates
 avenue, west, to city
 line; ward 15
Vincent Place, from 346
 State, east, to North St.
 Paul; wards 9, 5
Vine, from 14 East, east,
 to 15 N. Union; ward 10
Violetta, from 215 Plym-
 outh avenue, east, to
 G. V. canal; ward 8
Vose, from 128 Hudson,
 west, to Henry; ward 13
Vought, from 209 State,
 west, to opposite 39
 Frank; ward 2
Left. Rt.
 — State
 — Brown's alley
 — Lyell
Wackerman, fr. Camp-
 bell, north to Jay;
 ward 15
Wadsworth, from Hud-
 son, east, to North;
 ward 13

Wadsworth Square, on
 Broadway, between Ho-
 well and Marshall; wd. 7
Wait, from Scio, to He-
 bard, near City line -
 ward 10
Walbridge Park, from
 Lake avenue, between
 Cliff and White; ward 9
Wall, from 137 West ave-
 nue, south, to 16 West
 Troup; ward 8
Walnut, from 69 Magne,
 south, to Wilder; wd. 11
Left. Rt.
 — Magne
 — Smith
 — Jay
 — Orange
 — Campbell
 — Wilder
Ward, from 96 North St.
 Paul, east, to 126 North
 Clinton; ward 5
Left. Rt.
 — Shamrock
 — Emmet
 — North Clinton
Warehouse, from 64 Al-
 len, west, to 65 Brown;
 ward 2
Left. Rt.
 — Allen
 — Broad
 — Platt
 — Erie
 — Brown
Waring Road, continua-
 tion of Culver, north, to
 Norton; ward 16
Warner, fr. Lyell, north,
 to Otis; ward 15
Washington, see North
 Washington, or South
 Washington
Washington Square, on
 Court, between S. Clin-
 ton and South; ward 4
Water, see North Water,
 or South Water
Waverley, from Julia,
 east; wards 8, 3
Waverley Place, from
 South Ford, east; wd. 3
Webster, from 66 Hud-
 son, east, to 173 North;
 ward 13
Weeger, from Hudson,
 west, to Thomas; wd. 13
Weld, from 116 North,
 east, to North Union;
 wards 14, 10
Left. Rt.
 — North
 71 62 Scio
 87 82 North Union
Wentworth, from 183
 West avenue, north, to
 363 Brown; ward 8
 — West avenue
 — New York
 — Brown
Wesley, from North ave-
 nue, west, to Concord
 avenue; ward 14
West, fr. 90 Lyell, north,
 to House of Refuge;
 ward 9
Left. Rt.
 — Lyell
 — Jones avenue
 — Lorimer
 — Costar

STREET DIRECTORY.

West Alley, from Erie canal, south, to 38 Troup; ward 3
Left. Rt.
 — — Erie canal
 — — Spring
 — — Troup
West Avenue, a continuation of West Main street from Erie canal to the City line; wards 3, 8, 11
 1 Favor
 13 South Ford
 13 North Ford
 27 30 Trowbridge
 — — Gen. Val. canal
 57 Julia
 62 Canal
 71 Prospect
 86 Litchfield
 100 King
 115 Reynolds
 116 Madison
 122 North Frances
 121 Frances
 137 Wall
 136 Wentworth
 172 Brown
 177 184 Genesee
 — — North York
 178 Briggs' place
West Main, from west end Main street bridge, west, to the Erie canal; ward 1
Left. Rt.
 2 Front
 27 Aqueduct

Left. Rt.
 28 Arcade
 40 State
 37 Exchange
 69 Irving place
 70 Pindell alley
 105 98 Fitzhugh
 115 116 Montgomery al.
 131 Plymouth av.
 134 Sophia
 139 Spring alley
 140 Scott alley
 176 N. Washington
 169 S. Washington
 227 Caledonia av.
 232 Elizabeth
 — — Erie canal
West Maple, from 290 Brown, west, to City line; ward 11
Left. Rt.
 — — Brown
 — — N. Y. C. R. R.
 — — Saxton
 30 Orchard
 — — North York
 — — Childs
 — — City line
West Orange, fr. Ames, west; ward 15
West Troup, from 7 Reynolds, west, to Lambertson park; ward 8
Left. Rt.
 6 — 9 Frances
 — — Wall
Whalin, from Munger, south, to Grand; wd. 12

White, from Frank, east, to Genesee river; ward 9
 — — Frank
 — — State
 — — Cliff
White Alley, from Perkins, north, to Brisbane; ward 9
Whitmore Park, from Mt. Vernon av., south, to 96 Meigs; wd. 12
Whitney, from Wilder, north, to Lyell; ward 11
Left. Rt.
 — — Wilder
 — — Campbell
 — — Orange
 — — Jay
 — — Kondolf
 — — Smith
 — — Lime
 — — N. Y. C. R. R.
 — — Lyell
Widman, from Herman, north; wd. 13
Wilcox, from Monroe av. north, to Richard; ward 16
Wilder, from 268 Brown, west, to Wackerman; wards 11, 16
Left. Rt.
 — — Tonawanda
 8 Grape
 — — Walnut
 — — Saxton

Left. Rt.
 — — Orchard
 — — Whitney
 — — Childs
 — — Wackerman
Wilder Place, from East ave., south, to Nichols park; ward 16
William, from 57 East avenue, south, to 41 Howell; wards 4, 7
Left. Rt.
 2 East avenue
 6 Chestnut park
 23 James
 20 Court
 49 52 George
 — — Monroe avenue
 — — Howell
Wilson, from Hudson, east, to North; ward 13
Wolcott, from Clarissa, south, to City line; wd. 8
Woodbury, from 80 Hudson, east, to 181 North; ward 13
Woodford Place, from Harris Avenue to Conkey Avenue; ward 5
York, see North York or New York
Zimmer, fr. Bay, north, to Caspar; ward 16

METEOROLOGICAL RECORD,

FOR YEAR ENDING MAY 31, 1876. HOURS OF OBSERVATION: 7; 7.33; 11.58 A. M., AND 2; 4.33; 9; 10.58 P. M.
 Furnished by U. S. Signal Service Office, 212 Powers' Buildings.

MONTH.	THERMOMETER.			BAROMETERS.			WIND.	AM'T OF RAIN AND MELTED SNOW.				
	Date.	Maximum.	Date.	Minimum.	MEAN.	Highest.		Lowest.	MEAN.	Prevaling Direction.	Maximum velocity (per mile)	Amo'nt in Inches.
1875.												
June, - - -	24	94	14	41	66	30.18	29.65	29.94	W.	38	3.33	16
July, - - -	25	86	2 19	53	69	30.30	29.66	29.93	W.	36	2.12	12
August, - -	11	85	24	49	68	30.36	29.59	29.98	S. W.	24	5.08	16
September, -	9	89	23	36	58	30.42	29.48	29.98	W.	42	2.87	19
October, - -	23	75	31	31	46	30.46	29.35	29.92	W.	32	2.41	19
November, -	12	60	30	1	34	30.66	29.52	30.06	W.	48	2.14	16
December, -	31	70	20	-8	31	30.59	29.20	29.91	W.	33	2.91	22
1876.												
January, - -	1	68	13	8	31	30.60	29.14	30.02	W.	48	4.27	28
February, - -	14	52	2 5	3	26	30.82	29.15	30.04	W.	37	5.40	23
March, - - -	7	66	19	7	30	30.55	29.13	29.97	W.	30	3.89	22
April, - - -	14	70	2	21	42	30.53	29.26	29.95	W.	42	1.99	19
May, - - -	21, 27 28, 31	83	1	30	55	30.36	29.66	29.99	W.	30	1.53	15
Means, -					46.3			29.97		Totals,	37.96	227

A. R. PRITCHARD & LIKLY,

SOLID RED CEDAR TRUNKS,
 No. 78 STATE STREET.

Adams Myron, house 25 South Union
 Adams Nancy, widow, house 36 Kent
 Adams Nathaniel, shoemaker, h. 7 Warehouse
 Adams Nellie, dressmaker, bds. 183 State
 Adams Rebecca, dressmaker, 2 Kelly, h. do.
 Adams Reuben A. physician, 31 Fitzhugh,
 house do.
 Adams Robert, moulder, bds. 5 Campbell
 Adams Samuel W. removed from city
 Adams Sophia Mrs. house 44 Sibley block
 Adams Thomas J. tinsmith, boards Brown's
 alley near Lyell
 Adams Walter W. lawyer, 78 Powers' bldgs.
 boards 19 Troup
 Adams William, laborer, house 36 Kent alley
 Adams Wm. F. upholsterer, bds. 100 Mill
 Adamson John, house 124 University avenue
 Adderly Sarah Mrs. bds. 126 Mt. Hope av.
 Adelaide Sister, removed to Geneva
 Adelman Francis A. cigar manufacturer, 306
 Brown, house do.
 Adelman Francis G. bookkeeper, Rochester
 Brewing Co. boards 306 Brown
 Ades Robert jr. nurseryman, house Goodman
 near Brighton ave. [corner Culver
 Adlam Walter, laborer, bds. University ave.
 Adler Abram (*Stein, Adler & Co.*), 14 Mum-
 ford, house 7 Franklin square
 Adler Barbara, widow, house 35 Atwater
 Adler Fannie, clerk, 13 E. Main, b. 19 Vienna
 Adler Julia, widow, house 19 Vienna
 Adler Levi (*Stein, Adler & Co.*), 14 Mum-
 ford, house 51 Atwater [19 Vienna
 Adler Moses A. clerk, 35 East Main, boards
 Adlington Joseph A. lawyer, 77 Powers'
 buildings, boards 128 Plymouth ave.
 Adreansen James, clerk, River near North
 Water, house 28 Lowell [Pryor
 Adreansen Magdalena, widow, house 15
 Adsit Franklin, flour, 70 West ave. house 25
 Canal
 Adsit Samuel, clergyman, house 23 Meigs
 Adwen Joseph, moulder, house 26 Alexander
 Adwen Joseph, jr. carriage painter, 31 Mum-
 ford, boards 26 Alexander
 Adwen Stephen W. grocer, Brighton lock,
 Erie Canal, house do. [ander
 Adwen William A. tinsmith, boards 26 Alex-
 Aebersold Charles H. machinist, boards
 North avenue near Jennings
 Aebersold Christian, farmer, house North
 avenue near Jennings
 Aebersold Jacob M. optician, 179 North St.
 Paul, boards North ave. near Jennings
 Agan Joseph, laborer, Olean opp. Frost ave.
 Agne John F. clerk, County Clerk's office,
 Court House, boards Whitcomb House
 Agnes Sister, Convent of Nazareth, Jay cor.
 Frank [Sibley
 Agral Joseph, coachman, bds. East av. cor.
 Aha Andrew, carpenter, house West Maple
 corner Ames
 Aha John, carpenter, house 30 Mark
 Aha John, laborer, boards 111 Orange
 Aha Victoria M. seamstress, bds. 111 Orange
 Ahnfeld Charles, laborer, house 27 Wads-
 worth [near Bay
 Ahnfeldt Frederick, laborer, house Third ave.

Ahrens William, coachman, Chili road near
 West avenue, house do.
 Aiken Courtney, joiner, house 19 Clarissa
 Aiken John M. clerk, boards 19 Clarissa
 Aikenhead James M. (*McIntosh, Aikenhead &*
Co.), 55 Front, house 61 Tappan
 Aikenhead Mary, widow, house 63 Tappan
 Aikenhead William (*McIntosh, Aikenhead &*
Co.), 55 Front, house 63 Tappan
 Aikin Maria, widow, boards 114 Frank
 Ainley Hannah, dressmaker, boards 26
 Caroline
 Ainley Henry, mason, house 26 Caroline
 Ainse John, laborer, house 96 Pinnacle ave.
 Ainsworth Perley, agent, house West avenue
 near St. Mary's Hospital
 Airle John, machinist, Brown corner Jones,
 house 120 Orange [Hamburg
 Airy George T. carpet layer, 37 State, house 5
 Airy Lizzie J. stitcher, boards 23 Otsego
 Aiton James, deceased June, 1875
 Aiton Robert, carpenter, house 11 N. Union
 Aiton Robert J. boards 11 North Union
 Akay Abraham, varnisher, 74 State, house 76
 Mungler
 Akay Jacob, laborer, house 14 Bond
 Akey Thomas, laborer, house 21 Lancaster
 Akin Eugene C. student, University of Roch-
 ester, boards 80 Court
 Albee Henry C. collector agent, 23 Powers'
 Buildings, boards 57 North avenue
 Albee Josephus H. agent, boards 57 North
 avenue [58 Kelly
 Albert Edward, shoemaker, 124 Front, house
 Albert George, shoemaker, 47 Cady, house do.
 Albert George J. cabinet maker, boards 101
 Chatham [St. Joseph near Norton
 Albert Gustav, butcher, 163 W. Main, house
 Albert James, laborer, Erie freight house, h.
 Montrose corner Frank
 Albert Joachim, grocer, 101 Chatham, h. do.
 Albert Magdalena, widow, bds. 19 Wilson
 Albertson Charles S. salesman, 14 Exchange,
 house at Churchville [Adams
 Albrecht Anthony, baker, bds. Reynolds cor.
 Albrecht Frederick, cutter, 76 Mill, house 28
 Ward [near Pennsylvania ave.
 Albrecht Frederick, laborer, house First ave.
 Albrecht Fridolin, (*Albrecht & Niedermaier*),
 house Clifford near Edward
 Albrecht & Niedermaier (*F. Albrecht and J.*
Niedermaier), carpenters, Clifford near
 Edward
 Albright Aquilla E. widow, h. 149 Alexander
 Albright Henry, fireman, house 26 Orchard
 Albright Samuel, boxmaker, foot Centre,
 boards 173 North
 Albro Elizabeth, widow, house 5 Wilson
 Albro Fred. B. engineer, N. Y. C. R. R. bds.
 5 Wilson [5 Wilson
 Albro Jerome, fireman, N. Y. C. R. R. bds.
 Albro Josephine E. packer, 38 Gorham,
 house 94 North avenue
 Albro Martin V. teamster, 56 Hudson, house
 4 Wilson
 Albro Mary A. widow, house 94 North ave.
 Albro Oliver W. clerk, 7 East Main, boards
 5 Wilson

- Alcantara Sister, teacher, bds. Jay cor. Frank
Alden Frank S. printer, 1 Aqueduct, boards
107½ East Main
- Alden John F. civil engineer, Leighton
bridge and iron works, h. 15 N. Clinton
- Aldrich Adam & Co. (*T. F. Aldrich*), fruit,
143 State, house 46 Lorimer
- Aldrich Evander, baggage-man, N. Y. C. R.
R. house North cor. Concord avenue
- Aldrich Frank, clerk, 143 State, boards 46
Lorimer [44 Lorimer
- Aldrich Theodore F. (*A. Aldrich & Co.*), h.
- A**LDRIDGE GEORGE W. carpenter and
builder, 51 Powers' building and 97 Ex-
change, house 20 Fitzhugh.—*See page*
632
- Aldridge George W. jr. 97 Exchange, boards
20 Fitzhugh
- Aldridge Sarah A. widow, h. 141 Lake ave.
- Aldridge Walter S. salesman, 15 Mill, boards
141 Lake avenue
- Alexander Barbara, widow, house 19 Atwater
- Alexander Catharine, widow, house Plymouth
avenue near Flint
- Alexander Charles W. canvasser, b. 1 South
Alexander Frank, printer, house 106½ West
Main
- Alexander Frederick W. clerk, North Clin-
ton corner Atwater, boards 19 Atwater
- Alexander James, printer, 82 West Main,
house 84 Bartlett [h. 7 West Troup
- Alexander John, bookkeeper, 113 W. Main,
Alexander John H. tailor, 18 E. Main, house
160 Plymouth avenue
- Alexander J. Vincent, clerk, 1 Powers' build-
ings, boards 7 West Troup
- Alexander Robert W. groom, State corner
Centre, house 104 Allen
- Alexander Thomas, laborer, bds. 6 Hebard
- Alexander William B. hotel keeper, boards
275 North
- Alhart George, drover, house 202 North
- Allan Frances, widow, house 24 Savannah
- Allee Geo. wire weaver, 79 State, house 124
Adams [hattan
- Allen Alaschor T. carpenter, house 9 Man-
- Allen Albert S. carpenter, 114 North Water,
boards 100 Allen [23 Marietta
- Allen Andrew, engineer, N. Y. C. R. R. h.
- Allen Anna E. widow, bds. 21 North Frances
- Allen Anson C. (*Allen, Straus & Co.*), house
12 East Main
- Allen Bridget, domestic, b. 235 East Main
- Allen Bros. (*C. M. & H. N. Allen*), lawyers,
113 Powers' buildings
- Allen Calvin, removed to Lakeside
- Allen Charles M. (*Allen Bros.*), 113 Powers'
buildings, house 160 Exchange
- Allen Charles N. removed to Colorado
- Allen Charles W. millwright, paper mills,
house Bloss corner Backus avenue
- Allen Charles & T. W. looking glasses, 105
State, house 36 Elizabeth
- Allen Daniel P. house 186 East Main
- Allen David, carpenter, house 54 Lorimer
- Allen Eliza, house 7 Prospect
- Allen Elizabeth, widow, bds. 12 East Main
- Allen Elvira N. widow, boards 81 Fitzhugh
- Allen Eugene H. jeweller, 30 West Main, h.
7 Marshall
- Allen Frances, widow, boards 36 Elizabeth
- Allen Frances M. widow, house 39 Savannah
- Allen Francis H. 62 E. Main, b. 4 Park av.
- Allen Frank, peddler, 144 East Main
- Allen Frank B. policeman, City Hall, house
95 South avenue [boards 28 Asylum
- Allen Frank D. clerk, 128 Powers' bldgs.
- Allen Frank P. (*Allen & Wegman*), 62 East
Main, house 4 Park avenue
- Allen Frederick P. teller, Traders' National
Bank, 35 West Main, h. 19 South Union
- Allen Hannah B. widow, house 7 Dover
- Allen Geo. A. clerk, 178 State, b. Bloss c.
Backus avenue
- Allen Geo. E. clerk, 114 Powers' bldgs. bds.
28 Court [house 48 Kirk
- Allen George H. carpenter, 13 South Water,
- Allen George W. steward, Waverly House,
house 5 Shamrock
- Allen Gordon F. carpenter, h. 25 Evergreen
- Allen Henry N. (*Allen Bros.*), 115 Powers'
bldgs., house 16 Adams
- Allen Howard O. removed to Mendon
- Allen James D. clerk, 29 Powers' buildings,
boards 166 Exchange
- Allen James H. house 20 Asylum
- Allen John, flagman, Allen street crossing,
house 69 Orange [14, b. 4 Tappan
- Allen John G. principal, Riley School, No.
- Allen John W. carriage maker, h. 38 Gibbs
- Allen Lafayette, peddler, 144 East Main
- Allen Lauren P. removed from city
- Allen Levi, mason, house 31 Monroe avenue
- Allen Margaret, dressmaker, bds. 8 Hickory
- Allen Martha, widow, house 6 Concord av.
- Allen Mary Miss, boards 6 Smith
- Allen Mary, widow, boards 6 Smith
- Allen Milton, agent, boards 11 Centre park
- Allen Montlebert, painter, boards 28 Asylum
- Allen Nellie M. teacher, Oakman School,
No. 20, b. Evergreen n. Conkey avenue
- Allen Newell (*Proctor & Allen*), 14 State, h.
84 Plymouth avenue
- Allen Oliver E. boards Congress Hall
- Allen Orlando, boards 146½ West Main
- Allen Peter A. clerk, 53 E. Main, h. 74 Mt.
Hope avenue
- Allen Rebecca P. widow, house 100 Allen
- Allen Robert, railroad agent, h. 48 Lake av.
- Allen, Straus & Co. (*A. C. Allen, D. and S.*
Straus), clothiers, 24 West Main
- Allen Susan, widow, house 28 Asylum
- Allen Thomas B. ice dealer, h. Lewis n. Scio
- Allen Thomas B. engineer, boards Evergreen
near Conkey av. [house 6 Smith
- Allen Thomas H. fireman, N. Y. C. R. R.
- Allen Thomas W. (*C. & T. W. Allen*), 105
State, house 36 Elizabeth
- Allen Weston E. cutter, bds. 11 Centre park
- Allen Wm. railroad agent, 164½ State, house
11 Smith [9 South Ford
- Allen William, laborer, 187 West Main, bds.
- Allen William A. carpenter, 114 N. Water,
house 102 Allen
- Allen William A. laborer, b. 3 George's park
- Allen William B. painter, house 45 Cady

Allen William F. painter, boards 45 Cady
 Allen ——— widow, house 290 State
A LLEN & WEGMAN (*F. P. Allen and A. J. Wegman*), rubber hand stamp manufs. and steam job printers, 62 East Main.—*See opposite page 592*
 Allen, see Alleyn, Allyn and Alling
 Alley Eliza J. teacher, House of Refuge, boards 64 Lake av.
 Alley Emma S. Miss, teacher, Franklin School, No. 6, boards 64 Lake avenue
 Alley Hannah, clerk, boards 64 Lake av.
 Alley Rebecca W. Miss, house 64 Lake av.
 Alley R. Maria, teacher, House of Refuge, boards 64 Lake avenue
A LLING BROTHERS (*S. Y. and L. H. Alling*), tanners and leather dealers, 51 North Water.—*See page 665*
 Alling Charles E. bookkeeper, b. 28 Andrews
 Alling David C. carpenter, 28 Andrews, h. do.
 Alling Edward D. removed to Michigan
A LLING FRED. D. ink manufacturer, 19 Mill, h. 157 Plymouth av.—*See page 593*
 Alling Joseph T. student, Rochester University, b. 74 Fitzhugh [99½ Fitzhugh
 Alling Kenneth Y. clerk, 51 N. Water, bds.
 Alling Lewis H. (*Alling Brothers*), house 62 Plymouth avenue
 Alling Ophelia M. widow, house 13 Howell
 Alling Stephen Y. (*Alling Brothers*), house 99½ Fitzhugh [Fitzhugh
 Alling William (*Alling & Cory*), house 74
A LLING & CORY (*William Alling and D. Cory*), paper warehouse, 10 and 12 Exchange.—*See page 528*
 Allis Gardner S. (*Drew, Allis & Co.*), 114 Powers' buildings, boards 33 Greig
 Allis Hubbard S. house 23 East av.
 Allis James W. bookkeeper, 12 State, b 5 Oak
 Allis William D. shipping clerk, Rochester Paper Co. lower falls, house 5 Oak
 Allison John A. clerk, Leighton bridge and iron works, East Main, b. 15 N. Clinton
 Allman Annie M. dressmaker, boards 9 Jay
 Allman Mary, clerk, boards 9 Jay
 Allmeroth Henry, mason, house 41 Sanford
 Allmeroth Henry, mason, house Henrietta av. near Pinnacle avenue
 Allmeroth Henry J. mason, boards Henrietta av. near Pinnacle avenue
 Allmeroth William, mason, h. 43 Sanford
 Allseits Xavier, tailor, boards 40 East Main
 Allshouse George W. bookkeeper, foot of Centre, house 5 Vought
 Allyn Alonzo S. marbleworker, 33 S. St. Paul boards 15 Mortimer
 Allyn Athean C. clerk, 31 Reynolds' Arcade, house 78 Tappan [b. 15 Mortimer
 Allyn Cyrus, marble works, 33 S. St. Paul,
 Allyn Lewis, real estate, 16 East av. bds. 20 Elm
 Almeyda Eliza G. Mrs. boards 194 Oak
 Almstead Charles, clerk, bds. Stanley near reservoir
 Almstead David S. superintendent, reservoir, house Stanley near reservoir
 Almy Elmer E. boards 1 East avenue
 Almy Mary E. widow, house 1 East avenue

Aloysius Sister, removed to Geneva
 Alpeter Henry, finisher, h. Bay n. Fourth av.
 Alphonsus Sister, Convent Nazareth, Jay c. Frank [N. Stillson
 Alpsteg John R. clerk, 20 West Main, h. 1
 Alt George, machinist, house 61 Nassau
 Alt Jacob, cigar manuf. 6 E. Main, house 99 Caledonia av.
 Altheimer Samuel, market, 49 Clinton place, h. 39 University av.
 Altman William, clerk, 104½ Hudson, h 74 do. [103 Chatham
 Altpeter Christian, cabinetmaker, 74 State, h.
 Altpeter Jacob H. finisher, 73 State, h. Bay near Hebard [b. Bay n. Fourth av.
 Altpeter John, sawyer, River n. N. St. Paul,
 Altpeter John J. sawyer, house 9 Miller
 Altpeter Martha E. widow, house 137 Scio
 Aman Anton, cutter, 74 Mill, house 5 Pitt
 Aman Geo. laborer, h. Thomas near Bernard
 Aman Geo. jr. mason, h. Thomas n. Bernard
A MAN HENRY, druggist, 139 E. Main, h. 62 N. Clinton.—*See page 569* [nard
 Aman John, carpenter, h. Thomas near Ber-
 Aman Oscar A. clerk, 38 E. Main, b. 9 Pitt
 Aman Vincent, foreman, 74 Mill, h. 9 Pitt
 Amann Feltz, brewer, 139 N. St. Paul, h. 10 Galusha
 Amberg Samuel, removed to Germany
 Amborn Christian, baker, 102½ East av. h. do. [house 63 Hudson
 Ambrose Edward T. fireman, N. Y. C. R. R.
 Ambrose Margaret, widow, h. 41 S. Wash- ington
 Amelia Mary, teacher, bds. Jay c. Frank
 American Express Co. 83 State
A MERICAN TRACT SOCIETY, 75 State. —*See page 519* [Pinnacle av.
 Ames Edwin, teamster, h. Henrietta av. near
 Ames Gustavus, pulp, house 22 S. Clinton
 Ames John, peddler, house 28 Wilder
 Amesbury Robert, foreman, 11 Mumford, h. 11 White
 Amich Kate, domestic, boards 12 Gibbs
 Amidon Joseph, cabinetmaker, Court corner Stone, boards 48 Caledonia avenue
 Amidon Nelson, street car driver, b. 25 Allen
 Amiet Amelia Mrs. dry goods, 5 Lowell, h. do.
 Ammering Jacob, shoemaker, h. 126 Orange
 Ammering Louis, shoemaker, 124 Front, h. 9 Tonawanda [Water, h. 11 Tyler
 Amos Frederick A. shoe finisher, 73 North
 Amos William H. cutter, 55 Mill, house 81 South avenue
A MSDEN CHRISTOPHER T. & SON, (*F. J. Amsden*), insurance agents, Powers' bldgs. (*basement*), h. 16 Prince.—*See page 505* [Prince
 Amsden C. Henry, teller, 25 State, house 12
A MSDEN FRANK J. banker, Powers' bldgs. (*basement*), and (*C. T. Amsden & Son*), h. 20 Meigs.—*See page 505*
 Amsden Henry F. (*J. F. Amsden & Son*), bds. Whitcomb House
 Amsden Joel F. & Son (*H. F. Amsden*), dry goods, 36 State, boards Whitcomb House
 Amsden Louis A. student, University of Rochester, boards 16 Prince

HENRY C. WISNER,

PARIAN BUSTS AND FIGURES,
 No. 33 STATE STREET.

Amsler John G. carpenter, 193 N. Clinton,
h. Alexander near Bay
Anderson Ann, widow, house 74 Kent
Anderson Chas. E. removed to Pontiac, Ill.
Anderson Delia, vestmaker, h. 121 Frank
Anderson Edmund, trunkmaker, 78 State,
house 33 Andrews
Anderson Elizabeth P. widow, h. 13 Lyell
Anderson George W. painter, 50 West ave.
boards 74 Kent
Anderson Henry, waiter, 8 E. Main, b. do.
Anderson Henry, whitewasher, h. 82 Tremont
Anderson Jacob, candle manuf. 101 Ex-
change, house do.
Anderson Jeremiah N. removed to Canada
Anderson John, blacksmith, 12 Division, h.
24 Hickory
Anderson John D. collarmaker, b. 13 Lyell
Anderson Joseph M. umbrella repairer, h 25
Gibbs
Anderson Martin, deceased Dec. 1875.
Anderson Martin B. president University of
Rochester, h. University av. c. Prince
Anderson Riley, car driver, h. 18 Costar
Anderson Rosetta, whipmaker, b. 121 Frank
Anderson William, scavenger, h. 66 Troup
Anderson William A. agent, h. 109 Adams
Anderson Wm. C. student, University of
Rochester, boards East avenue
Anderson Wm. C. teamster, bds. 121 Frank
Anderson Wm. E. machinist, 87 N. Water,
boards 109 Adams
Anderson Wm. H. burnisher, 87 N. Water,
boards 33 Andrews
Anderson Wm. H. steward, h. 1 School alley
Anderson Wm. H. porter, 17 N. St. Paul,
boards do.
Andrew Mary, nurse, boards 43 Davis
Andrews Adna G. shoecutter, 55 Mill, house
27 Comfort
Andrews Ann Mrs. boards 50 S. Ford
Andrews Anthony E. saloon, 49 Front, h. do.
Andrews Bradford L. bootfitter, 55 Mill, h.
110 Plymouth avenue
Andrews Caspar, sawyer, house 26 Hawkins
Andrews Clarence E. agent, 53 E. Main, h.
123 Tremont [Caledonia av.
Andrews Emory P. music teacher, house 48
ANDREWS EZRA R. printer, 1 Aque-
duct and (Clague, Randall & Co.), and
(Benford & Andrews), house 226 Ex-
change.—See opp. page 512.
Andrews Frank F. clerk, 4 Exchange, bds.
32 Tremont
Andrews George, shoemaker, house 2 Huron
Andrews George C. shoemaker, boards 28
Hawkins [Mill, h. do.
Andrews George C. physician, Market cor.
Andrews George E. musician, bds. 48 Cale-
donia ave. [Jones, bds. 155 Wilder
Andrews Georgea H. machinist, Brown cor.
Andrews George W. salesman, 2 West Main,
boards 18 Joslyn Park
Andrews Hannah E. widow, h. 56 Chatham
Andrews Hiram L. laborer, bds. 27 Comfort
Andrews Ira W. pressman, b. 56 Chatham
Andrews James, blacksmith, 55 Fitzhugh,
boards Bantel Hotel

Andrews James S. bds. 33 N. St. Paul
Andrews Jefferson J. cigarmaker, 45 E. Main,
boards 246 W. Main
Andrews John, whitewasher, h. rear 24 Favor
Andrews Joseph, shoemaker, 15 Mill, bds.
27 Galusha [Caledonia ave.
Andrews Joseph E. clerk, 6 State, bds. 48
Andrews Julius, shoemaker, 642 West ave.
house 504 Brown
Andrews Julius T. 25 Andrews, boards
Osburn House
Andrews J. Sherlock, lawyer, 42 Powers'
bldgs. boards 33 N. St. Paul
Andrews Luther P. salesman, 65 N. Water,
h. 34 Meigs
Andrews Monroe, waiter, boards 34 Meigs
Andrews Newton E. machinist, Brown cor.
Jones, house 155 Wilder
Andrews Nicholas, mason, h. 28 Hawkins
Andrews Otto, boards 49 Front [house do.
Andrews Randall, shoemaker, 147 Frank,
Andrews Samuel G. Mrs. h. 33 N. St. Paul
Andrews Severe, upholsterer, 7 N. Water, b.
27 Galusha [32 Tremont
Andrews Sophronia W. dressmaker, house
Andrews Thomas, market, 92 Plymouth av.
house 20 Adams
Andrews Thomas, waiter, Osburn House
Andrews Wakeman Y. insurance surveyor,
under Powers' bank, h. 97 North av.
Andrews Willis, carpenter, 117 W. Main, h.
111 Meigs
Andrus Duane P. student, bds. 89 S. Union
Andrus Hiram O. clerk, 120 W. Main, bds.
16 Howell
Andrus Joseph D. house 16 Howell
Andyke Henry, cabinetmaker, h. 17 Webster
Andyke Henry F. clerk, 49 N. Clinton, bds.
17 Webster [bds. 3 Gibbs
Angel Charles H. perfumery manuf. 50 Mill,
Angel John, wheelman, house 4 Rhine
Angel Joseph F. carpenter, h. 33 Wardsworth
Angele Anthony, carriagemaker, 101 North
av. house 99 do. [99 do.
Angele Louis, blacksmith, 101 North av. b.
Angele Willibold, carver, 133 N. Water, h.
9 Langham [Tremont
Angell Andrew S. clerk, 44 Front, house 151
Angell Edward B. student, University of
Rochester, boards 42 Court [av.
Angell Welcome H. machinist, h. 102 West
Anger Peter, carpenter, 14 St. Joseph, house
26 Hebard [1 King
Angevine Edward, city clerk, City Hall, h.
Angevine George O. bookkeeper, 90 E. Main,
house 6 Vine
Angevine Mary, widow, house 2 Sophia
Angevine Oliver L. fire marshal, 130 Powers'
buildings, house 29 Frank
Angle Abram C. expressman, 35 Exchange,
house 93 Atkinson [Centre park
Angle James L. lawyer, 31 State, house 6
Angle Lovisie M. widow, house 23 1/2 Frank
Angles Sally Mrs. house 2 Atwater
Anguish Chas. baggageman, h. 42 North av.
Anker Otto, shoemaker, River n. North St.
Paul, boards 60 N. St. Paul
Annett Grace, stitcher, boards 8 St. Clair

Annett Hugh, carriagemaker, 3 Canal, bds. 8 St. Clair [St. Clair
 Annett James A. machinist, 3 Canal, bds. 8
 Annett John R. blacksmith, 3 Canal, bds. 8 St. Clair
 Annin J. Byron, deceased Oct. 1875
 Annis Cortlandt, ins. agt. 5 Powers' bldgs. h. 211 Monroe avenue
 Auscomb Thomas, house 2 Alexander
 Ansell Edmund, box maker, ft. Centre, h. 23 Otsego [Ambrose
 Ansell Henry, clerk, 76 Front, h. Frank cor.
 Ansell Jane, widow, boards 72 Platt
 Anstice Henry, rector St. Luke's church, h. 99 Fitzhugh
 Anstice Josiah, clerk, bds. 99 Fitzhugh
 Antes Susan, housekeeper, bds. 57 William
 Anthony Anthony, whitewasher, h. 16 South Ford
 Anthony Bros. (*D. M., G. and W. G. Anthony*), bakers, 139 N. Water
 Anthony Daniel M. (*Anthony Bros.*), h. 101 West av.
 Anthony Gideon (*Anthony Bros.*), house at Irondequoit
 Anthony Huldah, widow, h. 8 Trowbridge
 Anthony Leonard, teamster, b. 67 West av.
 Anthony Lucy, widow, boards 7 Madison
 Anthony Margaret, widow, b. 67 West av.
 Anthony Mary S. principal, Madison pk. school No. 2, boards 7 Madison
 Anthony Susan B. Miss, bds. 7 Madison
 Anthony William G. (*Anthony Bros.*), house 30½ Marshall
 Antoinette Sister, teacher, b. Jay c. Frank
 Antre Sophia, spectacle maker, 179 N. St. Paul, boards 26 Hawkins
 Antrim Jane, dressmaker, 85 West av. h. do.
 Anwander Thaddeus pastor, St. Joseph's church, house 24 Franklin
 Apfel Gottlieb, gardener, h. Miller near Bay
 Apfel John, car coupler, b. Miller near Bay
 Apfel J. Adam, gardener, b. Miller near Bay
 Apfel J. Geo. switchman, b. Miller n. Bay
 Apgar Peter L. clerk, 17 Powers' bldgs. bds. 5 Livingston place
 Appel Barbara, widow, house 47 Scrantom
 Appel John, agent, h. Lincoln c. Channing
 Appel John, machinist, house 17 Rhine
 Appel John, brewer, N. Clinton n. Clifford, house 302 North Clinton
 Appel John N. butcher, b. 434 Brown
 Appel Joseph A. drover, house 434 Brown
 Appel Margaret, stitcher, boards 47 Scrantom
 Appel Mary Miss, tailoress, 48 Martin, b. 47 Scrantom
 Appel Philip, mason, h. Thomas c. Bernard
 Appel William, student, Rochester Theological Seminary, b. 118 Alexander
 Apple John W. gate tender, N. Y. C. depot, house 253 North Clinton
 Apple William, machinist, b. 253 N. Clinton
 Appy Ernest, piano tuner, 86 State, bds. 48 Caledonia avenue [75 do.
 Appy Henri, music teacher, 68 E. Main, h.
 Aquey Louis, teamster, boards 332 State
 Aquinas Mary, teacher, b. Jay cor. Frank
 Archer Elizabeth, widow, b. 27 N. St. Paul

ARCHER GEORGE W. dental chair manufacturer, 7 North Water, house 27 North St. Paul.—See page 621
 ARCHER JOHN W. carpenter and cistern builder. 114 North Water near Andrews, house 31 Pearl.—See page 643
 Archer Ralph, carriage painter, 245 E. Main, boards 11 Chestnut park
 Archer R. W. Mrs. house 2 N. Washington
 Archer Wm. W. physician, 32 East av. h. do.
 Arden Milton, mason, house 104 Mill [do.
 Ardrey James G. publisher, 96½ E. Main, b.
 Ardrey Robert M. collector, b. 96½ E. Main
 Arend John, carriage painter, 148 Plymouth avenue, house do. [avenue
 Arens Frederick C. laborer, b. 196 Pinnacle
 Arens John, laborer, house 196 Pinnacle av.
 Arensmeier Gottfried, clerk, 25 West Main, b. 311 North Clinton [ton, c. avenue A.
 Arensmeier John, blacksmith, h. North Clinton
 Arensmeyer Henry, shoemaker, h. 97 North Clinton [North Clinton
 Arensmeyer Herman A. cigarmaker, bds. 97
 Arensmeyer John, cigarmaker, b. 97 North Clinton
 Arink Gerard, physician, 35 Andrews, h. do.
 Arkland Ezra, clerk, 144 North av. boards Miller's alley near Atwater
 Arkland Henry D. freight conductor, N. Y. C. R. R. h. Miller's alley, near Atwater
 Arkland John B. chairmaker, house Hastings near McCracken [McCracken
 Arkland John H. laborer, b. Hastings near
 Armatage Myron H. bookkeeper, 61 State. b. 133 Adams n. Frances
 Armatage Philo D. salesman, 61 State, house 133 Adams near Frances
 Armatage S. student, bds. 68 South St. Paul
 Armbruster Caspar, carpenter, h. 68 Weld
 Armbruster Charles, clerk, 151 East Main, b. 68 Weld
 Armbruster Frances, widow, house 43 Weld
 Armbruster Frederick, clerk, 148 East Main, boards 68 Weld
 Armbruster Lorenzo, deceased May 7, 1875
 Armbruster Max, brewer, b. 171 N. St. Paul
 Armfield Frederick G. morocco manuf. 321 North St. Paul, h. St. Paul opp. Norton
 Armitage William H. bookkeeper, 76 State, boards 5 Stillson
 Armitage William J. Mrs. house 5 Stillson
 Armour William, removed to Hamlin
 Armstrong Charles B. painter, h. 103 Hudson
 Armstrong Charles G. engine driver, No. 3, boards Magne near Jay [York city
 Armstrong Charles W. removed to New
 Armstrong Duane, salesman, 73 North Water, boards 27 North Clinton
 Armstrong Edmund W. physician, 14 North Washington, house do.
 Armstrong Ella, stitcher, boards 14 Lind
 Armstrong George, lawyer, 71 Powers' bldgs. boards 60 South St. Paul [Hudson
 Armstrong Henry A. painter, house 108
 Armstrong John, teamster, h. 272 N. St. Paul
 Armstrong John W. fireman, house 125 Scio
 Armstrong Joseph W. tallyman, Erie railway freight house, house 59 Court

HENRY C. WISNER,

KEROSENE CHANDELIERS, BRACKETS, AND LAMPS--No. 33 STATE STREET.

- Armstrong Luman W. laborer, house 1
Kondolf
- Armstrong Margaret A. boarding house, 9
South Ford, house do.
- Armstrong Melinda, widow, bds. 2 Pleasant
- Armstrong Peter, shoemaker, house 14 Lind
- Armstrong Peter N. pressman, bds. 14 Lind
- Arnett John, farmer, b. Genesee cor. Strong
- Arnold Abram (*C. Arnold & Co.*), house 4
Schleyer's block [18 East avenue
- Arnold Alfred W. salesman, 17 State, boards
- Arnold Boniface, peddler, house 25 Delevan
- Arnold C. & Co. (*A. Arnold*), fish market, 41
Front, house 134 East Main
- Arnold Daniel, shoemaker, h. 18 East av.
- Arnold Edward C. dentist, h. 63 Savannah
- Arnold Elias, salesman, house 101 Reynolds
- Arnold Elizabeth, widow, boards 6 Mill
- Arnold Eugene H. salesman, 17 State, bds.
82 West avenue
- Arnold Francis E. student, Roch. Theologi-
cal Seminary, boards Trevor Hall
- Arnold Frank, deceased April 9, 1876
- A** **RNOLD GEORGE**, sign and banner
painter, 109 State, house 15 Frank.—*See*
page 644
- Arnold George P. removed to Oakland, Cal.
- Arnold George W. finisher, h. 13 Sheridan
park [site Glasgow, h. 239 Exchange
- Arnold Henry A. machinist, Exchange oppo-
- Arnold Henry C. author, h. 63 Savannah
- A** **RNOLD HOBART G.** sash locks and real
estate, house Harvard corner Rowley.—
See page 507
- Arnold James carpenter, 46 Meigs, house do.
- Arnold James W. agent, boards 27 Adams
- Arnold John, laborer, h. 83 Pinnacle avenue
- Arnold John, painter, 111½ North Water, b.
8 Wilder
- Arnold John, laborer, house 20 Caroline
- Arnold Lauren B. water wheels, 1 Baker's
block, house at Gates
- Arnold Lydia L. widow, b. Pearl n. Edmonds
- Arnold Margare, widow, b. 114 N. St. Paul
- Arnold Mary, boarding house, 8 Wilder, h.
do.
- Arnold Minnie, clerk, boards 12 Evergreen
- Arnold Nathaniel, removed from city
- Arnold Philip (*Lynch & Arnold*), 11 South
avenue, house 15 Caroline
- Arnold Seth J. & Co. (*G. D. Warren and T.
J. Hurley*), dry goods, 101 State, house 45
Sophia [h. 13 Sheridan pk.
- Arnold William, varnisher, 7 North Water,
- Arnold William E. land agent, h. 30 Meigs
- Arnold W. Frank, removed to Mt. Morris
- Arnoldt George, civil engineer, 139 North St.
Paul, house 32 Strong cor. Seward
- Arnoldt Johanna Miss, boards 32 Strong
- Arnoldt Richard V. removed to Buffalo
- Arnot Elizabeth N. tailoress, boards 23 West
Troup
- Arnott Hezekiah, brass moulder, Court cor.
Stone. house 124 South avenue
- Aronson Mitchell, clerk, 3 East Main, boards
78 Atwater [78 Atwater
- Aronson Rudolph, clothing, 3 East Main, h.
- Arroll Ann, Mrs. house 3 Cliff
- Arroll James, shoemaker, State cor. Centre,
boards 33 Frank
- Arrows Sebastian, laborer, b. 105 Campbell
- Arrowsmith Frank, conductor, bds. 39 Madi-
son [roe av.
- Arrowsmith Nelson, gardener, h. 113 Mon-
- Arth Elizabeth, widow, house 27 Ward
- Arth George W. clerk, boards 27 Ward
- Asart Frank, waiter, Brackett House, boards
166 Exchange [h. 60 do.
- Ashby Edward, harness maker, 46 West av.
- Ashdown Jemima, widow, house 22 Magne
- Ashdown John, moulder, 20 Court, boards
40 Broadway
- Ashdown Thomas, gas inspector, 15 North
St. Paul. house 273 State
- Ashdown William H. laborer, at Citizens'
Gas Company, boards 22 Magne
- Ashley Clarence, house 14 Asylum
- Ashley Egbert F. clerk, 31 West Main, bds.
14 Asylum
- Ashley Eliza, widow, house 52 Franklin
- Ashley George W. clerk, boards 52 Franklin
- Ashley Isaac & Co. (*R. B. Ashley*), proprietors
Clinton Hotel, 28 Exchange, house do.
- Ashley Lorenzo B. boards Clinton Hotel
- Ashley Roscoe B. (*Isaac Ashley & Co.*), house
20 North Washington [8 Stillson
- Ashley William H. cashier, 83 State, house
- Ashley William J. discount clerk, City Bank,
34 State, and secretary Safe Deposit Co.
31 State, boards 28 Spring
- Ashley William M. house 15 Glasgow
- Ashman Charles W. tallow melter, house
Rowe near city line
- Ashton Charles, teamster, h. 11 Montrose
- Ashton George, paper box manuf. 91 North
Water, house at Brighton
- Ashton George F. printer, 25 West Main, h.
110 Frank [Troup, h. 26 Olean
- Ashton George H. teamster, Exchange opp.
- Ashton James S. machinist, Mill c. Factory,
boards 65 Champlain
- Ashton Jennie M. Mrs. dressmaker, house 24
Orange [4 Bolivar
- Ashton John H. shoemaker, 4 Allen, house
- Ashton Joseph, carpenter, h. 14 Hayward pk.
- Ashton Samuel, gardener, h. r. 65 Fulton av.
- Ashton Thomas (*Wilson & Ashton*), 125 N.
Water, house 103 Frank
- Ashton Thomas, teamster, h. 65 Champlain
- Ashton Thomas, coremaker, h. 20 Brown's
alley [h. 29 Jones av.
- Ashton T. Augustus, printer, 25 West Main,
- Askew Robert A. removed to England
- Asmuth Philip, butcher, 226 East Main, h.
33 Herman
- Aspall James R. conductor, N. Y. C. R. R.
boards Brackett House
- Aspenleiter Joseph, tailor, house 111 Scio
- Astles John W. foreman, 111 State, house
Frost av. cor. Reynolds
- Atchinson Geo. A. student, Roch. Theologi-
cal Seminary, h. 4 Ambrose [h. do.
- Atchison Eliza, dressmaker, 153 Fitzhugh,
- Atherall Isaac, boards 26 Oak [do.
- Atherton Mary, dressmaker, 45 S. Ford, h.
- Athridge Wm. G. clerk, 168 State, b. 65 Frank

Atkin Jane, widow, house 92 Caledonia av.
 Atkin William, gardener, house 96 Tremont
 Atkins Alvin S. clockmaker, h. 7 Maple pl.
 Atkins Esther A. dressmaker, 7 Maple place,
 house do.
 Atkins Jane, dressmaker, boards 12 Comfort
 Atkins John R. removed to Philadelphia
 Atkins Mary, boards 12 Comfort
 Atkins Richard, deceased April, 1st. 1876
 Atkins Richard H. harness maker, 65 State,
 boards 12 Comfort
 Atkinson Alice, widow, house 49 Tremont
 Atkinson Charles H. salesman, 17 Front, b.
 Strong near Genesee [bds. 49 Tremont
 Atkinson George, lockmaker, Court c. Stone,
 Atkinson Hobart F. 49 Powers' buildings, h.
 East avenue near Meigs
 Atkinson Thomas, house Strong n. Genesee
 Atkinson Thos. W. machinist, b. 49 Tremont
 Atkinson Wm. grocer, Clifton c. Summer,
 house do. [bldgs. house 8 Gibbs
 Atkinson William A. salesman, 17 Powers'
 Atlantic & Pacific Telegraph Co. 7 Arcade
 Atson Joseph, sawyer, N. St. Paul, Middle
 Falls, house 14 Hayward pk.
 Attridge Arthur, laborer, house 11 Penn
 Attridge Arthur F. laborer, Brown c. canal,
 house 10 Romeyn
 Attridge Chester, laborer, bds. 24 Campbell
 Attridge Henry, clerk, N. Y. C. R. R. freight
 house, Platt cor. Kent, b. 56 Litchfield
 Attridge Henry, fireman, house 22 Bolivar
 Attridge James, laborer, house North avenue
 near Norton [h. 9 Orange
 Attridge John, boilermaker, Brown c. Jones,
 Attridge John, glazier, Aqueduct, house 24
 Whitney [12 Orange
 Attridge John, boilermaker, 138 Mill, house
 Attridge Joseph, laborer, house 101 Smith
 Attridge Joseph, carpenter, house 154 Brown
 Attridge Mary, widow, house 56 Litchfield
 Attridge Richard, laborer, b. 24 Campbell
 Attridge Samuel, boilermaker, 138 Mill, h.
 12 Orange [h. 100 East av.
 Attridge Samuel, shoemaker, 2 N. Union,
 Attridge Thomas, carpenter, bds. 12 Orange
 Attridge Thomas, clerk, 6 S. St. Paul, bds.
 11 Orange [h. 11 Orange
 Attridge William, blacksmith, Pratt c. Kent,
 Attridge William, conductor, b. 56 Litchfield
 Attridge William, carpenter, h. 24 Campbell
 Attridge Wm. 2nd, carpenter, b. 22 Bolivar
 Attridge Wm. jr. machinist, b. 24 Campbell
 Attridge William J. machinist, bds. 99 Jay
 Atwater Mary W. widow, h. 8 Arnold park
 Atwell Austin, clerk, 52 State, boards 11
 Fitzhugh [avenue
 Atwood Amasa S. engineer, h. 108 North av.
 Atwood Charles E. removed to New York
 city [bds. 108 North av.
 Atwood Charles H. hairdresser, Congress Hall,
 Aubel Henry C. framemaker, 38 Gorham, b.
 17 Elizabeth place
 Aubel John H. whitener, house 27 Rauber
 Aubel Mary B. widow, h. 17 Elizabeth place
 Auer Henry, saugage, 32 Front, house do.
 Auer Henry, removed to Milwaukee, Wis.
 Auer Sebastian, saloon, 67 Front, house do.

Augenstein Charles, baker, 128 South avenue,
 house do.
 August Gottfried, house 72 Andrews
 Augustin J. Jacob, framemaker, 155 North
 Water, house 11 Elizabeth place
 Augustine Andrew, blacksmith, 3 Canal, h.
 83 Orange [Jay corner Frank
 Augustine Sister, teacher, Nazareth Convent,
 Auman Henry, tailor, house 7 Hanover
 Aumock Kate, widow, house 20 Channing
 Austin Andrew L. foreman, Erie railway de-
 pot, house 154 Exchange
 Austin A. Judson, machinist, Mill corner
 Factory, boards 66 Sophia
 Austin Caroline, widow, house 66 Sophia
 Austin Charles K. stockkeeper, 24 State, bds.
 126 Fitzhugh
 Austin Eugene C. packer, 177 East Main, h.
 19 Weld [Saratoga avenue
 Austin Frank D. baggageman, house 7
 Austin Frank E. Miss, boards 24 Centre
 Austin Franklin J. saloon, 77 Front, b. do.
 Austin James, butcher, 191 North, house do.
 Austin James G. market, 191 North, b. do.
 Austin Justus E. machinist, house 26 Stone
 Austin Margaret Mrs. hairworker, 26 Stone,
 house do.
 Austin Mary A. widow, house 46 Monroe ave.
 Austin Orville, removed from city
 Auten Charles, teamster, house Mt. Vernon
 avenue near Cayuga place
 Averell Isaac S. treasurer Ontario Iron Co.,
 90 Mill, boards 29 Plymouth avenue
 Averell William H. secretary Ontario Iron
 Co., 90 Mill, boards 29 Plymouth ave.
 Averill Henry, sailmaker, 46 Exchange, h.
 36 Caledonia avenue
 Avery Bridget, widow, h. 12 Vincent place
 Avery Charles B. removed from city
 Avery Cortland, clerk, 100 State, bds. Whit-
 comb House
 Avery Frederick W. (Creed & Avery), 29 W.
 Main, h. Francis near Troup
 Avery John S. sailmaker, 42 Exchange, h.
 7 Ashland
 Avery Mary J. Mrs. house 22 Caledonia ave.
 Avery Sidney S. (Steele & Avery), 44 State, h.
 14 Prince
 Avery Susan, tailoress, house 35 Tremont
 Avril August, cutter, house 319 N. Clinton
 Axt Rudolph, shoemaker, Andrews cor. N.
 Water, house 51 Oakman
 Axtell John S. painter, house 49 Cypress
 Ayer Sylvester, shoemaker, 124 Front, house
 125 State
 Ayers Charles B. Mrs. librarian Athenæum,
 Court House, boards 141 Lake avenue
 Ayers Frank J. house 44 Jones
 Ayers Frederick D. yard master, N. Y. C. R.
 R. boards 44 Jones [Mathews
 Ayers Henry P. miller at C. B. Hill's, house 5
 Ayers' Hotel, 82 Mill
 Ayers John B. saddler, boards 167 State
 Ayers L. C. Mrs. milliner, h. 171 Alexander
 Aylsworth Abel, machinist, Brown c. Jones,
 house 39 Oak
 Aylsworth Alice M. clerk, boards 78 Kent
 Aylsworth Isaac L. machinist, b. 78 Kent

Aylsworth Mary E. widow, house 78 Kent
 Aylsworth Norman, foreman, North Water,
 boards 78 Kent
 Ayrault Anna, widow, house 93 Fitzhugh

BABBAGE EDWARD F. removed to Natick,
 Mass [14 Allen

Babbage Edwin F. physician, 136 State, bds.
 Babbage John, sexton, Brick Church, house
 14 Allen

Babbage William W. book agent, b. 14 Allen
 Babbett Caroline Miss, dressmaker, boards 15
 William

Babbitt Charles R. civil engineer, 100 Powers'
 buildings, bds. 44 Caledonia avenue

Babcock Albert A. switchman, Erie R. R. h.
 1 Edinburgh [avenue

Babcock Almon B. tinsmith, h. 89 Mt. Hope
 Babcock Burdett, mason, h. 1 Chestnut park
 Babcock Butler, horse breaker, 11 Sibley's
 block, house do.

BABCOCK CHARLES H. coal, 57 Fitz-
 hugh, house 66 Plymouth avenue.—*See*
page 601

Babcock Elizabeth, widow, house 30 Fœhner
 Babcock Elizabeth A. widow, house 1 Jef-
 ferson park

Babcock Frances J. widow, bds. 51 Griffith
 Babcock Frank, clerk, bds. 16 Pinnacle ave.

Babcock George S. house 17 Mathews
 Babcock Harrison A. house 49 S. Clinton

BABCOCK HENRY H. agent, Anthracite
 Coal Association, 28 West Main and 51
 Hudson, house 91 Hudson.—*See page*
601

Babcock Horace J. removed to Lockport
 Babcock James, teamster, house Henrietta
 avenue near Allmeroth

Babcock John H. removed to Cleveland
 Babcock John W. bookkeeper, 36 E. Main,
 boards 37 Munger

Babcock Maggie Mrs. house 33 Stillson
 Babcock Nellie F. saloon, 188 West Main,
 house do. [block, house do.

Babcock Nellie T. dressmaker, 11 Sibley's
 Babcock Orrville C. saloon, 188 West Main,
 house do.

Babcock Polly, widow, bds. 1 Chestnut park
 Babcock Ulysses D. removed to San Fran-
 cisco, Cal.

Babcock William, boatman, house 37 Munger
 Babcock William A. tinsmith, 90 East Main,
 boards 30 Fœhner

Babcock Wm. J. treasurer, Rochester Opera
 House, boards 33 Stillson

Babcock William R. machinist, 10 S. Water,
 boards 54 South St. Paul

Babst Peter, clerk, 175 E. Main, h. 21 Weld
 Babst Peter G. machinist, Mill cor. Factory,
 bds. 21 Weld

Bach Frederick, varnisher, 71 North St. Paul,
 h. 18 Elizabeth place

Bach George, toolmaker, h. 62 Herman
 Bach John, removed to Holley

Bach John jr. shoemaker, 77 North Water,
 boards 95 North Union

Bach John, mason, house 95 North Union
 Bach John C. carpenter, b. 18 Elizabeth pl.

Bach William, gardener, house Goodman
 near Harvard [near Meigs

Bacher Peter, stonecutter, h. Cayuga place
 Bachmann August, trunk maker, bds. Ever-
 green near Conkey avenue

Bachmann Conrad, shoemaker, 73 North
 Water, house 33 Scrantom

Bachmann Frederick, blacksmith, h. Ever-
 green near Conkey avenue

Bachmann George, shoemaker, h. 31 Scrantom
 Bachmann George jr. shoemaker, 73 North
 Water, house 29 Scrantom

Bachmann Helena, widow, h. 82 N. Clinton
 Bachmann John C. shoemaker, 15 Mill, h. 21
 Vienna [Joseph

Bachmann Leander, blacksmith, house 74 St.
 Bachmann Simon, removed to Munchen,
 Germany

Back Arthur T. house 37 Greig [Bay
 Backman John, gardener, h. Goodman near
 Backus Albert, clerk, 69 West Main, house
 29 Phelps avenue cor. Backus avenue

Backus Azel, physician, 38 Troup, house do.
 Backus Charles E. (*Whybrew & Backus*), 6
 State, house 42 Gregory

Backus Edward (*Child & Backus*), 117 West
 Main, house 11 North Washington

Backus Elizabeth Mrs. cook, bds. 61 East av.
 Backus Harriet H. Miss, milliner, 40 State,
 boards 3 East avenue [Fitzhugh

Backus James M. grocer, 69 W. Main, h. 80
 Backus Ogden, student, boards 38 Troup

Backus Orrin foreman, South St. Paul near
 Griffith, house 28 Hamilton place

Bacon Charles H. laborer, house 26 Hill
 Bacon Franklin W. photographer, 55 E. Main,
 house 9 Grove [bds. 9 Grove

Bacon George W. photographer, 55 E. Main,
 Bacon Julia, widow, house 5 Briggs' blk.

Bacon Roger W. painter, b. 115 Plymouth av.
 Bacon Sarah Mrs. dressmaker, 25 Chestnut,
 house do. [ings, house 14 Gibbs

Bacon Theodore, lawyer, 74 Powers' build-
 Bacon Wm. B. carpenter, h. 115 Plymouth av.

Badger Annie, teacher, Concord School,
 No. 18, boards 8 Atkinson

Badger A. M. Mrs. widow, h. 8 Atkinson
 Badger B. H. salesman, 64 Mill, house at
 Fond du Lac, Wis.

Badger George E. machinist, b. 41 South av.
 Badger Grace A. teacher, Tremont School,
 No. 3, boards 8 Atkinson

Badger James G. painter, 41 South av. h. do.
 Badhorn Joseph, market, Jay cor. Childs, h.
 175 Jay [ington

Baehler Peter B. clergyman, house 13 Hunt-
 Baemler Charles, laborer, house Wackerman
 near Jay

Baer Louis, printer, boards 17 Leopold
 Baer Max A. clerk, 133 E. Main bds. 150 do.

Baer Seligman, cutter, 66 Mill, h. 17 Leopold
 Baetzel Anna M. widow, house N. Clinton
 near Clifford

Baetzel Jacob, shoemaker, 79 N. Water, h. N.
 Clinton n. Clifford

Baetzel Jacob (*J. G. Baetzel & Bro.*), North
 Clinton near Clifford, house near North
 Clinton near Vernon park

Baetzel J. George & Brother (*Jacob Baetzel*),
brewers, N. Clinton near Clifford, h. do.
Baeuerle John A. mason, house 57 Hanover
Baeuerlin Peter, laborer, house 11 Vose
Baeuerlin Philip, hairdresser, 1 S. St. Paul,
boards 11 Vose
Baeurle Jacob, grocer, 108 East av. house do.
Baggs William, gardener, house Culver near
Leighton avenue
Bagley Amos, carpenter, house 44 Scio
Bagley Betsey, widow, boards 18 Lake av.
Bagley Geo. W. C. clerk, b. 22 Anderson av.
Bagley Henric S. student, b. 12 Broadway
BAGLEY JACKSON, carriage maker, 17
North av. h. 85 Hudson.—*See page 603*
Bagley James E. carpenter, h. 22 Brown's al.
Bagley Johnson, house 250 East Main
Bagley Wm. peddler, house 68 Champlain
Bahan John, laborer, boards foot Cliff
Bahan Mary A. weaver, boards foot Cliff
Bahan Patrick, laborer, house foot Cliff
Baier John, cabinet maker, house 24 Syke
Bailey Augusta, milliner, boards 22 Lyell
Bailey Betsey M. Mrs. widow, b. 12 James
Bailey Charles H. lawyer, 106 Powers' bldgs.
house at Henrietta
Bailey Francis W. 22 East Main, boards
Whitcomb House
Bailey George, miller, Central Mills, house
28 Romeyn [York House
Bailey George P. letter cutter, 128 State, bds.
Bailey George W. removed to Mishawaka,
Ind. [Erie canal, bds. 12 James
Bailey George W. clerk, Alexander corner
Bailey Jacob G. removed from city
Bailey John, gardener, house St. Joseph n.
Norton [8 Wilson
Bailey John F. fireman, N. Y. C. R. R. house
Bailey John R. bookkeeper, 52 West Main,
boards 101½ Exchange [N. St. Paul
Bailey Joseph, porter, 68 Mill, h. Clifford n.
Bailey Joseph E. engineer, N. Y. C. R. R.
house 2 Helena
Bailey Lewis A. student, University of Roch-
ester, b. 58 Monroe avenue
Bailey Lucy, widow, h. 2 Oak
Bailey Richard C. porter, Osburn House, h.
14 Lawrence
BAILEY WELLS S. coal dealer, Alexan-
der corner Erie Canal, house 12 James.—
See page 599
Bailey William, bricklayer, boards 9 Stone
Bailey William C. agent, 32 Arcade, house
26 Adams [boards 2 Helena
Bailey William T. engineer, N. Y. C. R. R.
Bailey W. S. Mrs. dressmaker, 12 James,
house do. [Prince, h. 74 Weld
Bailly Jules, osteologist, College ave. near
Bainbridge Erasmus D. deputy sheriff, Court
House, house 14 William
Bainbridge Harry H. pavement, h. 144 Alex-
ander [change, bds. 134 E. Main
Bainbridge James P. flour and feed, 43 Ex-
Baine Archibald, bookkeeper, Andrews cor.
N. Water, boards 250 N. St. Paul
Baine William C. accountant, house 250 N.
St. Paul
Baird Alexander, carpenter, boards 14 Vine

Baird Alice, widow, house 14 Vine
Baird Hugh H. carpenter, 147 W. Main, bds.
12 N. Washington
Baird James, removed to Geneva, N. Y.
Baird John A. miller, Model Mills, S. Water,
house 17 N. Union
Baird Susan F. widow, house 144 North ave.
Baird William, carpenter, h 16 Vincent pl.
Baist George J. cutter, 36 Mill, h. 27 Catharine
Baker Abram V. salesman, 69 State, bds. 10
George's park
Baker Alfred A. shoemaker, 91 North Water,
house 25 Hand
Baker Alonzo D. peddler, boards 21 Ward
Baker Annie Miss, perfumer, 205 Plymouth
avenue, boards 28 Julia
Baker Asa S. Rev. house 162 West avenue
Baker A. Mrs. widow, house 24 Tappan
Baker A. E. Mrs. music teacher, 16 Mathews,
house do.
Baker Benjamin M. 12 Baker's block, house
76 Fitzhugh
BAKER BROS. (*G. and H. Baker, jr.*),
market, 258 State.—*See page 557*
Baker Caroline, widow, house 41 N. St. Paul
Baker Charles, teamster, Model Mills, boards
41 N. St. Paul [h. 38 St. Joseph
Baker Charles E. shoemaker, 44 Exchange,
Baker Charles E. clerk, 17 East Main, bds.
15 South Union [Main
Baker Charles F. clerk, 127 Mill, bds. 33 E.
BAKER CHARLES S. lawyer, 116 Pow-
ers' bldgs. h. 105 Lake av.—*See page 512*
Baker Charles S. machinist, bds. 31½ North
avenue [av. boards do.
Baker Charles W. physician, 87 Plymouth
Baker Delia Miss, house 51 Griffith
Baker Eliza B. widow, house 39 Alexander
Baker Elizabeth C. widow, house 25 Adams
Baker Ellen S. Miss, teacher, Genesee School
No. 4, boards 49 Clifton
Baker Emma L. widow, house 15 S. Union
Baker Erastus A. cigar manufacturer, 117
State, house do.
Baker Frank, removed from city
Baker Frank A. asst. superintendent, House
of Refuge, b. do.
Baker Franklin, clerk, 13 E. Main, bds. rear
8 Atwater
Baker Frederick, laborer, house 101 Lyell
Baker George, machinist, Brown c. Jones, h.
33 North avenue [avenue
Baker George (*Baker Bros.*), b. 102 Pinnacle
Baker Geo. carpenter, 3 Canal, h. 8 Waverley
Baker George L. (*Ranney & Baker*), house at
Gates
Baker George O. bookkeeper, b. 15 S. Union
Baker George Stuart, removed to Batavia
Baker George S. cartman, h. 97 Atkinson
Baker George W. deceased March 24, 1876
Baker Harmon P. carpenter, b. 39 Alexander
Baker Harriet, widow, house rear 8 Atwater
Baker Henry, butcher, h. 102 Pinnacle av.
Baker Henry, car driver, h. 21 Vincent pl.
Baker Henry, jr. (*Baker Bros.*), boards 102
Pinnacle avenue [Ontario
Baker Henry C. policeman, City Hall, h. 34
Baker Henry J. removed to Garbuttville

HENRY C. WISNER,

DECORATED CHINA, SILVER SETS,
No. 33 STATE STREET,

Baker Homer B. box maker, foot Centre, b. N. Union c. Lewis
 Baker Hudson T. shoemaker, h. Richards c. Boardman [av. h. do.
 Baker Isaac C. portrait painter, 13 Lake
 Baker Isaac F. shoemaker, 91 N. Water, h. 235 North corner Dayton [141 do.
 Baker James, grocer, 144 North ave. house
 Baker James, mason, boards 67 Adams
 Baker James F. deceased April 25, 1876
 Baker James F. Mrs. widow, house 101 Lake avenue
 Baker John, truckman, house 34 Champlain
 Baker John, engineer, house 20 North ave.
 Baker John, bone gatherer, h. N. Clinton n. city line
 Baker John, teamster, boards 60 Tremont
 Baker John, scavenger, house 3 Thorn alley
 Baker John, clerk, 144 North av. b. 3 Ontario
 Baker John, engineer, N. Y. C. R. R. house 31 North Frances [h 39 Alexander
 Baker John E. restaurant, 4 Railroad avenue,
 Baker John E. insurance agent, 47 Troup, house do.
 Baker John H. tanner, boards 75 Atkinson
 Baker John H. boat builder, boards 80 Pearl
 Baker John W. finisher, boards 93 Adams
 Baker John W. truckman, house 28 Julia
 Baker Joseph, carpenter, Exchange opp. Glasgow, house 29 Adams
 Baker Judah, widow, boards 2 Pleasant
 Baker Louis, shoemaker, 91 N. Water, bds. 235 North [Co. N. Y.
 Baker Lucius B. removed to St. Lawrence
 Baker Marcus L. overseer Penitentiary, h. South corner Stanley
 Baker Margaret, widow, house 75 Atkinson
 Baker Mary Miss, packer, 182 State, boards 60 Tremont [13, bds. 72 Hickory
 Baker Mary C. teacher, Munger School No.
 Baker Michael, laborer, h. 6 Marion
 Baker Michael, stonemason, 22 West av. h. 1 East Maple
 Baker Michael J. laborer, house 119½ Adams
 Baker Philo, teamster, b. 3 Thorn alley
 Baker Richard, house 3 Ontario
 Baker Richard, cartman, house 60 Tremont
 Baker Richard, switchman, Brown st. crossing, house 34 Litchfield [Atkinson
 Baker Robert, driver, 45 Fitzhugh, house 31
 Baker Robert, house 67 Adams
 Baker Robert C. removed from city
 Baker Rosa Miss, forewoman, 11 E. Main, b. rear 8 Atwater
 Baker Solon F. agent, house 83 East Main
 Baker Susanna, widow, house 58 Griffith
 Baker Tallman P. shoemaker, 83 N. Water, house 51 Sanford [Adams
 Baker Thomas, driver, 33 West av. bds. 119½
 Baker Thomas, carpenter, h. 35 Prospect
 Baker Walter C. S. machinist, h. 318 State
 Baker Wm. butcher, 258 State, b. 102 Pinnacle av.
 Baker William F. produce, h. 18 Jackson
 Baker William H. lawyer, 62 Arcade, boards 20 North avenue
 Baker William Y. house 32 Fitzhugh
 Baker, see Becker

Baldock Eliza, widow, boards 77 Allen
 Baldwin Caroline Miss, bds. 51 S. Clinton
 Baldwin Chas. J. pastor, First Baptist church, h. 58 Plymouth avenue
 Baldwin David S. expressman, h. 14 Nassau
 Baldwin Enos. cashier Safe Deposit Co. 31 State, h. 141 University avenue
 Baldwin Franklin L. h. 135 Lake avenue
 Baldwin F. W. salesman, 73 E. Main, bds. 146½ W. Main
 Baldwin John, deceased Aug. 25, 1875
 Baldwin Joseph, teamster, bds. 32 Franklin
 Baldwin Laura Miss, house 9 Greenwood av.
 Balfe Edward, carpenter, bds. 4 N. Stillson
 Balfour George, tailor, house 12 Wait
 Balkam Henry G. reporter, 28 Arcade, bds. 124 Fitzhugh
 Balkam William F. supt. Mecantile Agency J. M. Bradstreet & Son, 28 and 30 Arcade, boards Whitcomb House
 Balke Christian, baker, 95 N. Clinton, h. do.
 Balke Christian jr. baker, 95 N. Clinton, boards do.
 Balkhaus Frederick, tailor, h. 224 W. Main
 Ball Benjamin, cigarmaker, bds. 75 Manhattan [47 Savannah
 Ball Charles L. coachman, 145 E. Main, h.
 Ball Frank Mrs, boards 1 Grace
 Ball George S. wagonmaker, 100 S. St. Paul, house 33 Delevan [18, bds. 1 Grace
 Ball Hattie L. teacher, Concord School No.
 Ball Henry E. agent, 132 Powers' bldgs, h. 10 Hawthorn
 Ball James, laborer, house 1 Grace
 Ball Morris, painter, house 42 Lancaster
 Ball Patrick, laborer, Smith near R. R. h. 5 Garden
 Ball Rachel P. widow, bds. 19 Ambrose
 Ball Thomas H. button manuf. h. 19 Ambrose
 Ball William, 2½ Mill, h. r. 45 South avenue
 Ball William E. laborer, bds. 111 E. Main
 Ballantine Margaret A. portrait painter, 195 Powers' bldgs, b. 51 Spring
 Ballantine M. Jeanette, stenographer, 133 Powers' bldgs. boards 9 Franklin
 Ballard Elizabeth Mrs. h. 19 Mt. Hope av.
 Ballard Hiram, gardener, h. Stewart near North avenue
 Balliett Mary Miss, boards 58 Hunter
 Balling John, varnisher, 6 Front, bds. Ulm near Bay
 Balling Mary A. widow, h. Ulm near Bay
 Ballinger Jacob, laborer, house Caroline near Meigs [11 Eagle
 Ballinger John C. bookbinder, 55 State, h.
 Ballman Henry, laborer, house 7 Joiner
 Ballou George H. salesman, bds. 62 S. Union
 Ballou Henry S. grocer, 161 East Main, h. 62 S. Union
 Ballway Floren, widow, h. 26 Tappan
 Balscr John, teamster, house Mt. Hope av. n. Nursery
 Balthesberger John, tailor, h. 88 Pinnacle av.
 Baltman Leander, helper, 3 Canal, bds. 64 St. Joseph
 Balzer Augustus, house 40 Grand
 Balzer Valentine J. carver, Rowe n. Lake av. bds. 40 Grand

A. R. PRITCHARD & LIKLY,

SOLID RED CEDAR TRUNKS,
 No. 78 STATE STREET.

Bamann Frederick, salesman, 103 State. h. 84 Atwater
 Bamber Henry, tinsmith, 11 Monroe av. h. 52 Savannah
BAMBER JOHN, stoves, tinware, &c. 11 Monroe, av. h. 8 Edmonds.—See p. 593
 Bancker John, real estate, 163 E. Main, h. 198 do. [bds. 122 North av.
 Bancker John J. (*Westfall & Co.*), 28 E. Main, Bandel Chas. tailor, bds. 4 Thomas
 Banford Mary Miss, stitcher, b. 93 Atkinson
 Banghard Oswald, bookkeeper, 106 Lake av. house 52 Lowell
 Bangs Henry E. salesman, house 1 Pearl
 Banham Frederick, printer, 23 W. Main, h. 49 Colvin
 Banham Josiah, tailor, house 41 Charlotte
 Bank of Monroe, 22 Exchange

BANK OF ROCHESTER, 41 State.—See page 501.

Banker Benajah, laborer, h. 69 Pinnacle av.
 Banker Burlington, painter, b. 69 Pinnacle avenue [13 Selden
 Banker Edwin O. foreman, 3 Aqueduct, h.
 Banker Geo. W. painter, h. 43 Monroe av.
 Banker Jennie Mrs. widow, bds. 13 Selden
 Banker John W. machine operator, 83 North Water, house 90 South avenue
 Banks Louise N. widow, bds. Briggs' place
 Banning Albert R. (*W. A. Banning & Bro.*), boards 31 Meigs
 Banning Charlotte, widow, bds. 31 Meigs
 Banning William A. & Bro. (*A. R. Banning*), painters, 14 Stone, h. 31 Meigs
 Bannister Lawrence S. house 30 Comfort
 Bannister Lucy, widow, house 66 Asylum
 Bannister Lucy Miss, hairworker, boards 66 Asylum [Brown's race, b. 35 Cherry
 Bannister Marshall, bookkeeper, foundry,
 Bansbach Charles, papermaker, h. Vernon park [Vernon park
 Bansbach John, shoemaker, 87 N. Water, b.
 Banta Aaron, shoemaker, 124 Front, house 23 Caroline [West Troup
 Banta Andrew J. salesman, 16 State, house 1
 Banta Ann E. seamstress, boards 23 Caroline
 Banta Edwin R. clerk, 124 Front, house 8 Oakland park
 Banta Ida M. teacher, Madison park school, No. 2, boards Brisbane near Fulton av.
 Banta Lucinda L. widow, house Brisbane n. Fulton av. [Smith, house do.
 Banta Olivia M. Mrs. boys clothing, State c. house do. [Lake avenue
 Bantel George, sales stable, rear 142 Lake av. [Lake avenue

Bantel Joseph, market, 126 Lake av. b. 142
BANTLEON DAVID, turning and sawing, 123 North Water, h. 144 Scio.—See p. 649
 Bantleon Margaret Miss, boards 144 Scio
 Bantleon Sophia, teacher, St. John's German school, Buchan park, boards 144 Scio
 Barbeau Harriett, widow, boards 12 Glasgow
 Barber Albert D. & Son, (*A. H. Barber*), wood, 10 Spring, house 9 do. [Spring
 Barber Albert H. (*A. D. Barber & Son*), b. 9
 Barber Albert L. salesman, 53 E. Main, h. 6 Joslyn park [nia
 Barber Augustus H. removed to Califor-

Barber Charles R. student, University of Rochester, boards 6 Charlotte
 Barber Dolphus S. foreman news room, 23 West Main, house 39 Greig
 Barber George, boards 16 East avenue
 Barber George H. boards 10 Greig
 Barber Gilbert P. clerk, 10 Spring, b. 9 do.
 Barber Robert, watchmaker, Court c. Stone, house 43 Chestnut
 Barber Samuel A. machinist, b. 10 Greig
 Barber Samuel B. marble worker, h. 10 Greig
 Barber William, carpenter, 87 Exchange, b. 146½ West Main
 Barbour Thomas S. student, Rochester Theological Seminary, boards Trevor Hall
 Barbrick Agnes, widow, b. Bay c. Ulm
 Barclay Richard H. tool temperer, 136 Mill, house 6 Jay
 Bardeen Amy Mrs. physician, Reynolds cor. Clifton, house do.
 Bardeen Ferdinand, physician, Reynolds c. Clifton, house do.
 Bardeen Malancy, widow, house 50 Pearl
 Bardell Margaret, widow, bds. Frances near Hunter
 Bardwell Butler, house 74 North Clinton
 Bardwell John M. boards 23 South avenue
 Bardyn Coleman, pastor, Bith Israel Congregation, house 10 Joiner
 Bardyn Israel, tailor, boards 10 Joiner
 Barend John, mason, h. Eighth n. Emerson
 Barg Christian, laborer, house 43 Hoeltzer
 Barg Frederick, laborer, house 35 Hoeltzer
 Barg Frederick jr. mason, house 35 Hoeltzer
 Barg Frederick C. tailor, boards 43 Hoeltzer
 Bargo Warner B. laborer, h. Rapids road n. Genesee
 Barhydt Eliza, widow, house 19 Hill
 Barhydt James A. removed from city
 Barhydt Joseph, laborer, house 50 Hebard
 Barhydt Lavinia Mrs. boards 2 Oak
 Barhydt Rachel M. Miss, artist, h. 444 Brown
 Barker Benedict F. fireman, house Childs n. Jay [h. 49 Caledonia av.
 Barker Cyrus W. carpenter, 187 West Main,
 Barker Edmund, painter, boards 76 Frank
 Barker Hiram L. lawyer, 14 State, boards 16 Monroe avenue
 Barker Ida M. Miss, removed to Greece
 Barker John, house 19 Kent
 Barker John, engineer, house 63 Frank
 Barker John H. engineer, N. Y. C. R. R. b. 319 East Main
 Barker Kate Mrs. house 16 Spring
 Barker Malley, widow, house 76 Frank
 Barker Mandeville J. bookkeeper, 144 East Main, house 13 Grove
 Barker Mary Mrs. boards 52 Munger
 Barker Mary A. Miss, boards 76 Frank
 Barker Orrin, house 16 Monroe avenue
 Barker Wm. C. boards 63 Frank
 Barkery Margaret, waiter, Whitcomb House
 Barlow Ambrose S. house 26 South Union
 Barlow Ann, widow, house 1 Warehouse
 Barlow Betsey, widow, boards 7 Tappan
 Barlow Wm. fireman, boards 13½ Marietta
 Barnard Charles, express messenger, house 41 Vienna

Barnard Charles G. boards 48 Allen
 Barnard Delia, widow, b. 315 East Main
 Barnard Elbert J. removed to Dubuque, Ia.
 Barnard George B. shoemaker, 15 Mill, house
 66 Hickory [h. 152 Exchange
 Barnard George T. conductor, Erie Railway,
 Barnard Henry jr. bookkeeper, City Bank,
 34 State, house 24 Meigs
BARNARD JOHN C. paints and oils, ar-
 tists' materials, 23 Front, b. 315 E. Main.
 —See page 625
 Barnard John M. house 48 Allen
 Barnard Lucina Mrs. boards 16 Chatham
 Barnard Lucretia E. dressmaker, h. 53 Court
 Barnard Mary, widow, house 29 Stone
 Barnard Sarah Miss, boards 29 Stone
 Barnard William, contractor, b. 66 South av.
 Barnard Wm. C. (*Tice & Barnard*), 26 Allen,
 house 62 Platt [b. York house
 Barnard Wm. W. teamster, 65 North Water,
 Barnehl Sophia, widow, boards 46 Kirk
 Barnes Albert M. brakeman, b. 100 Mill
 Barnes Alexander, music teacher, h. 4 Erie
 Barnes Alonzo, removed to Brockport
 Barnes Edward, clerk, boards 35 Spencer
 Barnes Eliza (*Caowhra & Barnes*), Lake av.
 c. White, house foot of White
 Barnes Ezra L. carpenter, house Evergreen
 near Evergreen park
 Barnes Henry, carriage painter, boards foot
 White near Cliff [44 Tremont
 Barnes Henry F. carpenter, 3 Canal, house
 Barnes Hiram M. removed toodus
 Barnes James, clerk, 41 Monroe avenue, b.
 35 Spencer [h. 315 do.
 Barnes John E. carriage maker, 277 State,
 Barnes Miles S. salesman, 17 State, house 53
 Frank [10 Champlain
 Barnes Oscar R. clerk, 53 East Main, house
 Barnes Thomas, millinery, house 29 Court
 Barnes Thomas L. millinery, b. 29 Court
 Barnes William E. foreman, h. 35 Spencer
 Barnes Wilsey G. (*Barnes & Co.*), 14 East
 Main, b. 66 University av.
 Barnes & Co. (*W. G. Barnes*), patent medi-
 cines, 14 East Main
 Barnett Thomas, laborer, house 23 Goodman
 Barnett Byron W. framemaker, 123 State, h.
 53 Bolivar
 Barnett George J. clerk, 38 Gorham, house
 Av. A near Conkey av.
 Barnett John, gardener, h. r. 10 Brighton av.
 Barney Andrew F. shoemaker, 55 Mill, h. 84
 Cypress [b. 84 Cypress
 Barney Charles H. machinist, Shawmut bldg.
 Barney Peter, boatman, b. Perkins c. White al.
 Barnhardt Michael, laborer, foot Rowe, h.
 126 Lake avenue
 Barnhart Amanda, dressmaker, h. 2 Charlotte
 Barnhart Emma C. Miss, boards 31 Ambrose
 Barns Charles, cutter, 73 E. Main, house 8
 Woodbury
 Barns Charles jr. cutter, boards 8 Woodbury
 Barns John, painter, 188 State, bds. Orange
 corner Grape
 Barnum Alfred, carriage painter, 31 Mum-
 ford, house 15 North Washington
 Barnum Elizabeth, seamstress, b. 44 S. Union

Barnum Esther, widow, house 44 S. Union
 Barnum George A. printer, 1 Aqueduct, b.
 15 North Washington
 Barnum Harriet A. widow, h. 8 Gardiner pk.
 Barnum John T. bds. East av. n. Vick pk.
 Barnum Julia C. Mrs. house East av. near
 Vick park
 Barnum Juliette Miss, bds. 44 South Union
 Barnum Nathaniel C. clerk, 17 West Main,
 boards East avenue near Vick park
 Barnum Richard, teamster, paper mill, h. 18
 Champion [8 Gardiner pk.
 Barnum William R. clerk, 22 W. Main, bds.
 Barons George, wagon maker, h. 100 Strong
 Barons Hugh, cooper, boards 6 Sherman
 Barons James, cabinetmaker, b. 6 Sherman
 Barons Michael T. cooper, Smith corner Erie
 canal, boards 6 Sherman [Sherman
 Barons Patrick, cooper, 1 St. James pk. h. 6
 Barons Thomas C. boarding house, 28 Vin-
 cent place, house do.
 Barons William, sawyer, bds. 170½ W. Main
 Barons, see Barron
 Barr Isabella Mrs. removed to Albion
 Barr Joseph A. removed to N. Y. city
 Barr Max, bartender, bds. Farmers Hotel
 Barr William jr. gasfitter, 81 East Main, b.
 18 Allen [1 Tonawanda
 Barraud Pierre, cabinetmaker, 184 State, h.
 Barrett A. Judson, clergyman, house 55 Ful-
 ton avenue [h. do.
 Barrett Delia Mrs. dressmaker, 127 E. Main,
 Barrett Edmund, boat builder, h. 14 Hamil-
 ton place [ton place
 Barrett Edmund T. mason, house 12 Hamil-
 Barrett Edward, brakeman, house 87 Davis
 Barrett Edward S. draughtsman, 73 Arcade,
 boards 12 Hamilton place
 Barrett Frank C. machinist, Brown corner
 Jones, boards Myrtle near Lyell
 Barrett John, constable, house Monroe av.
 near toll gate
 Barrett John R. house 46 Clifton
 Barrett Martin J. boiler washer, Brown cor.
 Jones, house Myrtle near Lyell
 Barrett Patrick, stonecutter, h. 20 Seward
 Barrett Philander, horse dealer, h. 57 Uni-
 versity avenue
 Barrett Robert, boat builder, house 112 Oak
 Barrett Robert jr. boards 112 Oak
 Barrett Thomas, laborer, bds. 153 N. Union
 Barrett Thomas E. boat builder, b. 112 Oak
 Barrett Ward F. bookkeeper, 36 State, b. 46
 Clifton [av. cor. Field
 Barringer George, gardener, house Pinnacle
 Barron A. J. Miss, teacher, Concord School,
 No. 18, boards 1 Draper
 Barron Lawrence, saloon, 11 West av. h. do.
 Barron Marion, saloon, 172 E. Main, h. do.
 Barron Martin, coal, 138 Oak, h. 47 Frank
 Barron Robert, musician, bds. 39 Jones av.
 Barron, see Barons
 Barrows Helen M. widow, house 40 Lyell
 Barrows Henry H. foreman, house 25 Jones
 Barrows Howard A. bookkeeper, 74 Mill,
 boards 7 Meigs
 Barrows James J. conductor, Erie railway,
 boards at Dansville

- Barrows Melvin, house 7 Meigs [av.]
 Barry Ann, finisher, paper mill, h. 134 Lake
 Barry Charles A. blacksmith, 3 Canal, boards
 9 Prospect
 Barry Charles P. 134 Mt. Hope av. boards
 Mt. Hope avenue near Linden
 Barry David, watchman, house 2 Kent alley
 Barry David jr. carpenter, bds. 2 Kent alley
 Barry Fanny, widow, house 70 Chestnut
 Barry James, waiter, Osburn House
 Barry John, policeman, City Hall, house 32
 University avenue
 Barry John, grocer, 76 South av. house do.
 Barry John, laborer, house 55 Litchfield
 Barry John, laborer, boards 70 Chatham
 Barry John A. tucker, house 170 Jay
 Barry John H. (*Bennett & Barry*), lumber,
 140 Lake av. house 117 do.
 Barry Kate, milliner, b. Fulton av. c. Perkins
 Barry Kate, domestic, boards 44 East av.
 Barry Kate, domestic, boards 46 Spring
 Barry Michael, boat builder, h. 71 South av.
 Barry Patrick (*Ellwanger & Barry*), house
 Mt. Hope avenue near Linden
 Barry Patrick, fireman, house 52 Jay
 Barry Patrick, marble polisher, 122 South
 St. Paul, house 9 Bond [field
 Barry Robert, laborer, 92 Allen, b. 55 Litch-
 Barry Robert, removed to Vermont [kins
 Barry Thomas, tanner, h. Fulton av. c. Per-
 Barry Thomas F. deceased
 Barry William C. 134 Mt. Hope av. house
 Mt. Hope av. near cemetery
 Barry Wm. H. laborer, boards 70 Chestnut
 Barson Phenice, teamster, house 56 Gregory
 Bartell Henry, grocer, 178 West av. h. do.
 Bartels Frederick, harness maker, 98 East
 Main, boards 23 Hoeltzer
 Bartels Frederick T. laborer, h. 23 Hoeltzer
 Bartels Henry, carpenter, house 21 Baden
 Bartels Mary, removed from city
 Barth Frank, tailor, 4 Mill, h. 35 Hollister
 Barth George, carpenter, house 37 Vienna
 Barth Jenny, boards 1 Thompson
 Barth John A. porter, 44 Mill, house 21
 Thompson
 Barth Leonard, boards 16 Almira
 Barth Philip, laborer, house Hollenbeck
 Barth Peter (*Barth & Zeislein*), house 1 Cata-
 ract near North St. Paul
BARTH & ZEISLEIN (*P. Barth and G.
 Zeislein*), cabinet manufacturers, 69 North
 St. Paul.—*See page 620*
 Barthel Bernard, shade painter, 9 W. Main,
 house 216 North Clinton
 Barthelman Barbara, widow, boards West
 Maple near Ames
 Barthelman Lawrence, blacksmith, Brown
 corner Jones, house W. Maple n. Ames
 Barthelme Ignatz, turner, 2 Hill, h. Waker-
 man near Jay
 Barthelme Peter A. cabinetmaker, 2 Hill, b.
 8 Wilder [Joseph
 Bartold George, shoemaker, boards 197 St.
 Bartold Nicholas, mason, h. 197 St. Joseph
 Barthold Ferdinand, shoemaker, 87 North
 Water, house 262 St. Joseph
 Barthold see Berthold
 Bartholf Edwin, salesman, C. B. Hill's bds.
 Clinton Hotel
 Bartholf Stephen, house 29 Pearl
 Bartholick George A. physician, 12 Glasgow,
 house do. [Miller
 Bartholoma Frank, teamster, house Bay near
 Bartholoma George, deceased, Dec. 21, 1875
 Bartholomay Brewing Co. 139 North St. Paul
 Bartholomay Cornelius, optician, 179 North
 St. Paul, bds. 156 North Clinton
 Bartholomay Frederick, blacksmith, Scran-
 tom near Clinton, h. 65 Scramtom
 Bartholomay Henry, brewer, 139 North St.
 Paul, house do. [Paul, boards do.
 Bartholomay William, brewer, 139 North St.
 Bartholomew Conrad, carpenter, house 40
 Catherine [Wilder
 Bartholomew Elizabeth, widow, b. Saxton n.
 Bartholomew Frederick (*Veyhl & Bartholo-
 mew*), 9 Front, house 11 Morris
 Barthorn Leo, brewer, h. 175 North St. Paul
 Bartl Elizabeth, widow, house Wilder cor.
 Whitney [Whitney cor. Wilder
 Bartl George C. trimmer, 3 Canal, boards
 Bartl Joseph F. blacksmith, 3 Canal, house
 10 Whitney
 Bartlett Arden C. grocer, 164 State, house do.
 Bartlett Arthur H. painter, 22 South St. Paul,
 house Mansion near Magnolia
 Bartlett Ezra A. removed to Albany
 Bartlett George W. bookkeeper, 20 E. Main,
 house 149 Plymouth avenue
 Bartlett George W. painter, house Jennings
 near North avenue
 Bartlett Jennie D. Mrs. house 164 State
 Bartlett Thomas E. solecutter, 124 Front, h.
 25 Oak
 Bartley Frank, carpenter, boards 20 Pryor
 Bartley Joseph R. agent, 42 State, house 20
 Manhattan
 Barton Alvin L. lawyer, 117 Powers' bldgs.
 house 16 Canal
 Barton Andrew, carpenter, h. 27 W. Maple
 Barton Ann, widow, h. 16½ Hamilton place
 Barton Anna, dressmaker, 9 N. Clinton, bds.
 16½ Hamilton pl.
 Barton Charles, foreman, 91 State, house
 Pinnacle avenue near Field
 Barton Charles C. president D. R. Barton
 Tool Co., Mill cor. Furnace, h. 26 Spring
BARTON D. R., TOOL COMPANY, edge
 tool manufs. 120 Mill corner Furnace.—
See page 676
 Barton Edward M. tool temperer, 120 Mill, b.
 40 North Clinton
 Barton Emma C. house 127 West Main
 Barton Fanny A. widow, house 16 Canal
 Barton George P. removed to Chicago
 Barton Henry E. removed to Burlington, Ia.
 Barton James, grocer, 73 Lake ave. h. do.
 Barton Sarah M. widow, h. 40 N. Clinton
 Barton Spencer, clerk, 53 East Main, h. 70
 Mt. Hope avenue [Kent
 Barton William H. II. clerk, 17 State, h. 20
 Bascom Chauncey H. removed to Burling-
 ton, Vermont
 Bascom William H. tinsmith, 65 Exchange,
 house Tremont n. Genesee Valley canal

HENRY C. WISNER,

WHITE CHINA DINING and TEA SETS,
 No. 33 STATE STREET.

Basler August, porter, 36 Exchange, bds. 20 Prospect
 Basnip Edward, flour packer, Flour City Mills, house 150 North St. Paul
 Basnip Emma, dressmaker, boards 150 North St. Paul [Paul
 Basnip William E. teamster, b. 150 North St.
 Bassett Albert G. druggist, 350 State, h. 70 Jones [Adams
 Bassett Arthur M. clerk, 28 Arcade, bds. 13
 Bassett Egbert B. clerk, 12 State, boards 49 Clifton [house do.
 Bassett Henriette Mrs. stamping, 140 State,
 Bassett Mary E. Mrs. teacher, Madison park school, No. 2, house 49 Clifton
 Bassett William, foreman, 97 Exchange, h. 47 William [Exchange, h. 13 Adams
 Bassett William T. (Williams & Bassett), 85
 Bassett William T. plumber, 66 East Main, boards 47 William [42 Allen
 Bastable Charles, salesman, 73 East Main, b.
 Bastable Charles, machinist, 10 South Water, house 28 Chestnut
 Bastable Charles B. boards 28 Chestnut
 Bastable Fred. J. machinist, Brown c. Jones. boards 189 West avenue [42 Allen
 Bastable James (Bastable & McDonald), house **DASTABLE & McDONALD** (J. Bastable and J. McDonald), grocers, 42 Allen.— See page 537
 Bastian Fred. B. baker, house rear 159 South avenue [50 Caledonia avenue
 Bastian George H. baker, 90 West avenue, h.
 Bastian Henry, shoemaker, 142 Jay, h. do.
 Bastman John, laborer, N. Y. C. depot, h. 10 Helena [3 Grand
 Bata Pionia Sister, St. Boniface school, bds.
 Bates Arthur, clerk, bds. 5 N. Washington
 Bates Arthur H. salesman, h. 4 S. Clinton
 Bates Arthur R. tinsmith, 16 South St. Paul, boards 130 East Main [house 1 Olean
 Bates Ezra, teamster, Frost avenue c. Olean,
 Bates Frank deW. physician, 27 Fitzhugh, boards 31 do.
 Bates Hannah, widow, house 28 Elm
 Bates Harriet I. Miss, bds. 28 Elm
 Bates Joseph N. printer, bds. 4 Fehner
 Bates Thomas C. boards Osburn House
 Bates William, house 5 Vernon
 Bates William, mason, house 41 Romeyn
 Bates William M. (Bates & Pike), 61 Powers' buildings, house 68 Clifton
 Bates & Pike (Wm. M. Bates and J. B. Pike), lawyers, 61 Powers' buildings
 Bathgate Margaret, nurse, h. 218 W. Main
 Bathorn Leo, brewer, 139 N. St. Paul, house N. St. Paul cor. Vincent pl.
 Batt Margaret, widow, boards 15 Marion
 Batt Peter V. produce, house 15 Marion
 Battelle Ernest L. clerk, 61 E. Main, boards 13 Oak
 Battelle William H. & Co. druggists, 61 East Main, house 13 Oak
 Batterson George W. kindling wood, foot N. Water, house 125 Broadway
 Batterson Isaac, shoemaker, h. 129 Broadway
 Batterson John, shoemaker, 73 N. Water
 Batterson Theodore E. house 10 Hickory

Batterson William L. tuner, house 62 Mount Hope avenue
 Battz Peter, optician, 179 N. St. Paul, boards Bay n. North av
 Baty Sarah L. Mrs. house 97 Broadway
 Batz George, cooper, 180 Jay, house Hague
 Bauch John, laborer, house 25 Broadway
 Bauch John, laborer, house 5 Hoeltzer
 Bauer August F. L. blacksmith, 3 Canal, h. 43 Hand
 Bauer Charles F. laborer, h. 56 Hoeltzer
 Bauer Christina, widow, house 21 Hoeltzer
 Bauer Elizabeth Miss, bds. 48 N. Clinton
 Bauer Ferry, laborer, house 29 Davis
 Bauer Francis J. music teacher, 54 Andrews, house do. [house Edward
 Bauer Frederick, shoemaker, 77 N. Water,
 Bauer George, driver, boards 3 Achilles
 Bauer George, butcher, h. 204 Jay
 Bauer Jacob, cooper, h. 6 Walnut n. Magne
 Bauer John, clerk, 144 East Main, house 16 Buchan park
 Bauer John, teacher, St. Joseph's School, b. 18 Franklin
 Bauer John, laborer, house 35 Cole [Gregory
 Bauer John, wagonmaker, 3 Canal, house 38
 Bauer John, laborer, 139 N. St. Paul, bds. 171 do.
 Bauer John, driver Steamer No. 2, Stillson cor. E. Main, house 3 Achilles
 Bauer John jr. marblecutter, 122 S. St. Paul, boards 3 Achilles
 Bauer John A. saloon, 21 Tonawanda, h. do.
 Bauer John G. tailor, house 23 Woodbury
 Bauer Louis, house 126 West avenue
 Bauer Marcellus, sausage manuf. 52 Front, house do.
 Bauer Margaret, widow, boards 6 Campbell
 Bauer Michael, confectioner, 88 St. Joseph, house do.
 Bauer Theodore, saloon, 198 St. Joseph, h. do.
 Bauer William, fisherman, house Maria near Cliford
 Bauer, see Bower
 Bauerschmidt Adam, sausage manufacturer, and (Bauerschmidt & Fromm), 34 Front, house do.
 Bauerschmidt & Fromm (A. Bauerschmidt & C. Fromm), market, 34 Front
 Bauly Kate, sewing, boards 13 Anson park
 Baum Charles, clerk, 97 East Main, boards 99 Caledonia avenue [c. Adams
 Baum George H. butcher, boards Reynolds
 Baum George P. blacksmith, h. 104 Hunter
 Bauman Barnhardt, finisher, 184 State, bds. 3 Hope [nacle avenue
 Bauman Catharine, tailoress, boards 204 Pin-Bauman Frederick, farmer, h. Waring road near Norton
 Bauman Frederick J. grocer, Monroe avenue corner South Union, h. Pearl n. Meigs
 Bauman Henry J. peddler, house Second av. near Bay [avenue
 Bauman Henry J. mason, h. Seward n. Frost
 Bauman Jacob, tailor, house 102 Campbell
 Bauman John, grocer, 146 Plymouth av. house do.
 Bauman Mary, widow, house 3 Hope

- Bauman Michael, cutter, 24 State, house 26 Bartlett [242 North
Bauman Samuel, cabinetmaker, 123 Mill, h.
Baumann Louis, machinist, Brown c. Jones, house 114 Campbell [Ames
Baumeister Maria, widow, h. Orange n.
Baumer Clara, dressmaker, b. 41 Hudson
Baumer George, laborer, h. 278 N. St. Paul
Baumer John C. upholsterer, 107 State, bds. York House
Baumer Mary Miss, dressmaker, h. 5 Leopold
Baumgart Henry, cabinetmaker, boards 63 Sanford
Baumgart Peter, laborer, house 63 Sanford
Baumstark Elizabeth, widow, h. 95 Hudson
Baumstark Kunigunda, widow, h. 168 N. Clinton [house 95 Hudson
Baumstark William, clerk, 3 West Main,
Baunach Michael, laborer, house Maria near Clifford
Baur Augustine, foreman, house 26 Orange
Bausch Edward, spectacle maker, boards 5 *St. Joseph [205 N. St. Paul
Bausch Edward E. (*Bausch & Dransfield*), h.
Bausch George, optician, 179 N. St. Paul, b. 10 Catharine [b. 5 St. Joseph
Bausch Henry, machinist, 179 N. St. Paul,
Bausch Jacob, optician, 179 N. St. Paul, b. 10 Catharine
Bausch John G. (*Bausch & Lomb Optical Co.*), 179 N. St. Paul, h. 10 Catharine
Bausch John J. supt. B. & L. O. Co. 179 N. St. Paul, house 5 St. Joseph
Bausch William, optician, 179 N. St. Paul, boards 5 St. Joseph
BAUSCH & DRANSFIELD (*Edward E. Bausch & Thomas Dransfield*), opticians, 20 Arcade.—*See page 515*
Bausch & Lomb Optical Company, (*J. G. Bausch and H. Lomb*), manuf. optical instruments, 179 N. St. Paul
Bausum Geo. F. student, Fitzhugh cor. W. Main, boards 27 Chestnut [House
Bawden John, hostler, 4 Otsego, b. Collins'
Baxendale Margaret F. boards 93 Frank
Baxendale Thomas, machinist, h. 93 Frank
Baxendale Thomas R. machinist, h. 93 Frank
Baxendale William J. machinist, b. 93 Frank
Baxter Mary, widow, house 38 Tremont
Baxter Wm. H. peddler, 144 E. Main, boards 9 Lancaster [66 Joiner
Bay George, cutter, Mill c. Mumford, house
Bayer John, engineer, 123 Mill, h. 3 Hanover
Bayer John jr. deceased Aug. 1875 [Norton
Bayer Joseph H. boards rear N. Clinton n.
Bayer Lioba Mrs. grocer, 306 North Clinton, house do.
Bayer Wendell, saloon, 56 Front, house do.
Baylies Alfred, house 23 S. Union
Baylies Catharine, widow, house Conkey av. near Clifford [Prince, h. 36 Hickory
Bayliss George C. coachman, East ave. cor.
Bayliss Henry W. boards 32 Stone
Bayliss James H. plumber, bds. 36 Hickory
Beach Albert H. dentist, 87 E. Main, b. do.
Beach Chas. agent, boards 64 Chatham
Beach Chas. H. tallyman, Platt cor. Kent, h. 42 Chestnut
Beach Charles R. printer, 23 W. Main, house 35 Broadway [145 Alexander
Beach Daniel B. lawyer. 105 Powers' bldgs. h.
Beach Fred. H. printer, 23 W. Main, house 6 Fulton av. [house do.
Beach George L. physician, 48 South avenue,
BEACH JOSEPH S. plumbing and gas fitting, 17 Mill, house 6 Union park.—*See page 625*
Beach Lafayette, clerk, boards 65 Lyell
Beach Orrin W. shoemaker, 124 Front, house 35 Kelly
Beach Samuel G. agent, house 33 Pearl
Beach Sarah A. widow, house 65 Lyell
Beach Wm. shoemaker, h. r. 37 Monroe av.
Beach William H. boards 6 Fulton avenue
Beagle Maria Mrs. house 63 Monroe avenue
Beahan Catharine, widow, house 19 Romeyn
Beahan James, physician, 139 West av. h. do.
Beal Annis Miss, house 15 Mathews
Beal Ferdinand, tailor, house 23 Hudson
Beam George A. salesman, 7 West Main, h. at Dundee
Bean John, laborer, boards 8 Otis
Bean Mary J. widow, h. rear 43 Monroe av.
Beans Barney, laborer, house Henrietta av. near Allmeroth [52 Jones
Beard Frederick E. salesman, 53 E. Main, b.
Beard Harry K. removed to Canada
Beard William, painter, h. 187 Alexander
Beardslee George E. expressman, h. 19 Jones avenue [buildings, h. 9 Glasgow
Beardsley Cyrus, civil engineer, 100 Powers'
Beatrice Mary Sister, teacher, St. Bridget's School, bds. Jay cor. Frank
Beattie George, broom maker, 5 North Ford, house 9 do.
Beattie Martin, produce, house 91 Lake av.
Beattie Paul T. broom maker, 5 North Ford, boards 9 do.
Beatty Alexander, waiter, Osburn House
Beauchamp Joseph, machinist, Clinton Mills, house 4 Lake av. [Lake av. h. do.
Beauchamp Martha Mrs. confectionery, 4
Beaudoin Alphonse, carpenter, boards 28 Lancaster [bds. 114 W. Main
Beaumont John, waiter, 25 Exchange place,
Beaumont Rosa, widow, bds. 15 Fitzhugh
Beaumont Wm. butcher, 61 Lyell, boards do.
Beazley James J. wood worker, b. 29 Canal
Beazley John, carpenter, house 29 Canal
Bebee Maria A. Miss, boards 10 Adams
Bebee Mary M. widow, house 10 Adams
Bebee, see Beebee
Bechteler John B. produce, 55 Hudson, h. do.
Bechtold Henry, wagon maker, 277 State, house 404 Brown
Bechtold Valentine, laborer, house 3 Caspar
Beck Anna Sister, Notre Dame, Hudson cor. Clifford
Beck Anthony, nailer, h. N. Clinton n. Norton
Beck Christine, house 174 State
Beck David, clerk, 76 Mill, boards 31 Rhine
Beck Edwin B. (*L. P. Beck & Bro.*), 87 East Main, house 72 Scrantom
Beck Fidel, tailor, house 17 Oakman
Beck Francis, hay market, 213 State, h. do.
Beck Frank, farmer, h. Eleventh n. Emerson

Beck Frederick, bartender, boards 174 State
 Beck Frederick A. tailor, house 11 Holland
 Beck Frederika, widow, house 14 Grape
BECK GEORGE, native wine manuf. re-
 moved to Charlotte.—*See page 580*
 Beck John, stone cutter, house 37 Lowell
BECK LOUIS P. & BRO. (*E. B. Beck*),
 boots and shoes, 87 East Main, house 7
 Selden.—*See page 540*
 Beck Ludwina, tailoress, bds. 50 Sanford
 Beck Margaret, widow, house 50 Sanford
 Beck Martin, removed to Dayton, O.
 Beck Marx, stone cutter, house 5 Gregory
 Beck Wm. laborer, b. N. Clinton n. city line
 Beck Wm. E. printer, 33 Exchange, boards
 34 Charlotte
 Becker George G. carver, 2 Hill, h. 10 Wait
 Becker Gottfried, carpenter, h. 20 Edward
 Becker Henry L. lunch room, Exchange pl.
 corner Mill, bds. 28 Ward
 Becker John, machinist, house 8 Bartlett
 Becker John E. machinist, 124 Mill, house 13
 Flower [Plymouth n. Magnolia
 Becker Joseph, laborer, 178 Plymouth av. h.
 Becker Louis, turner, 111½ North Water, bds.
 82 St. Joseph
 Becker Louisa B. tailoress, bds. 52 Caroline
 Becker Mary T. tailoress, house 52 Caroline
 Becker Philippine Mrs. peddler, house 25
 McDonald avenue
 Becker Wilhelmina, widow, b. 119 South av.
 Becker William M. salesman, 123 State, house
 34 Grape
 Becker, see Baker
 Becket Elizabeth J. widow, h. 1 Hamilton pl.
 Beckett Thomas H. removed from city
 Beckler Delia, widow, boards 13 Galusha
 Beckler Marks, shoemaker, 87 North Water,
 bds. 111 W. Maple [b. 111 W. Maple
 Beckler Martin, shoemaker, 87 North Water,
 Becklie Chas. cabinetmaker, b. Ames n. R. R.
 Beckman Wm. G. moulder, house 9 Jackson
 Beckmann Charles, laborer, house 16 Hoeltzer
 Beckwith Francis X. removed to Gates
BECKWITH H. & J. K. nurserymen, bet.
 East avenue and Monroe av. at Brighton.
 —*See page 527* [Rowe cor. Third
 Beckwith Thomas D. clerk, 112 State, house
 Beckwith Wm. clerk, University avenue c.
 railroad, h. do. [mouth avenue
 Beckwith William T. agent, boards 122 Ply-
 Bedard William, tailor, house 89 Smith
 Beddie Alice A. boards 21 Swan
 Bedford Henry R. miller, house 11 Romeyn
 Bedner Lena, widow, house 14 Rhine
 Bedwin Ann, widow, h. Plymouth av. n. Flint
 Bedwin Charles A. cutter, 77 North Water,
 bds. Plymouth avenue near Flint
 Bedwin Thomas, shoe cutter, 83 N. Water,
 bds. Plymouth avenue near Flint
 Bedwin William J. gilder, 110 Front, house
 Mansion near Flint
 Beebe Julia, widow, bds. 73 Plymouth av.
 Beebe Martin, plasterer, house 149½ E. Main
 Beebee Ashman, house 19 Park avenue
 Beebee Elijah (*Hoves & Beebee*), 111½ North
 Water, house at Albion
 Beebee, Beebe and Beebe

BEEMER MARTIN V. gents' furnishing
 goods, 18 West Main, house 83 East
 avenue.—*See page 541*
 Beers Almira F. Mrs. boards 88 Fitzhugh
 Beers Horace J. salesman, 37 State, h. 10 Oak
 Beesch Jacob, foreman, 87 East Main, house
 10 Wilson
 Beeso Frank, laborer, house 28 Magne
 Beeton William, clerk, bds. 27 Platt
 Begy Christina Miss, bds. 4 Gorham
 Begy Frank J. saloon, 21 Exchange place,
 house 4 Gorham
 Begy George A. supt. of carriers, Post
 Office, house 7 East Maple
 Begy Joseph, cooper, Smith n. Erie canal,
 house 3 Tonawanda
 Begy Joseph A. removed from city
 Beha John, cabinet maker, 117 North Water,
 house 143 St. Joseph
 Behan Elizabeth, widow, house 52 Frank
 Behan Thomas J. removed to Buffalo
 Behmer John H. finisher, 22 S. St. Paul,
 bds. 23 Herman
 Behmer John P. polisher, house 23 Herman
 Behn Joachim J. cigarmaker, 21. Front,
 house 3 Gorham [house 17 Maria
 Behner Gustave E. boot crimper, 87 Front,
 Behnke Henry, saddlemaker, b. 6 Widman
 Behnke William, laborer, house 57 Herman
 Behnke William C. laborer, house 6 Widman
 Beideck William, tailor, house 86 Champlain
 Beikirch Albert, shoemaker, h. 153 Pinnacle
 avenue
 Beikirch Jacob, grocer, 186 Pinnacle av. h. do.
 Beikirch John, shoemaker, 157 Pinnacle av.
 house do.
 Beikirch William, tailor, b. 186 Pinnacle av.
 Beilby Henry carpenter, house 39 Oakman
 Beilby Thomas F. carpenter, h. 5 Thorn
 Beilman Henry J. painter, 3 Canal, b. 9 Ford
 Beimer Herman, porter, 76 Mill, bds. 60½
 Andrews [18 Chestnut
 Beir Albert, salesman, 46 East Main, boards
 Beir Asher, 46 East Main, house 18 Chestnut
 Beir David, clerk, bds. 18 Chestnut
 Beir Edward A. bookkeeper, 25 Mill, bds.
 18 Chestnut
 Beir Isaac, clerk, house 11 Kelly
 Beir Isaac J. (*Beir & Co.*), 12 Arcade, bds.
 59 Atwater
 Beir Joseph (*Beir Stern & Co.*), and (*Beir &*
Co.), house 59 Atwater
 Beir Lena, carpets, 46 East Main, house 18
 Chestnut [Atwater
 Beir Sigmund S. salesman, 74 Mill, bds. 59
 Beir, Stern & Co., (*J. Beir, A. and I. Stern*),
 dry goods, 66 Mill [12 Arcade
 Beir & Co. (*I. J. and J. Beir*), tobacconists,
 Beirds Maggie J. bds. 44 N. Union
 Beirlee Gottlieb, laborer, house 307 North
 St. Paul [South, bds. do.
 Beirnes Isabel, janitor St. Mary's school, 15
 Beisheim August, machinist, bds. 105 Meigs
BEISHEIM HENRY machinist and air
 gun manuf. 145 N. Water, h. 102
 Meigs.—*See page 674*
 Beisheim Jacob, moulder, 150 North Water,
 house 105 Meigs

A. R. PRITCHARD & LIKLY,

TRUNKS AND BAGS, WHOLESALE AND
 RETAIL, No. 78 STATE STREET.

Beisheim Justus, patternmaker, ft. Platt, house 72 Hickory
 Beisiegel Jacob, removed to Cincinnati, O.
 Beisiegel John jr. trunkmaker, boards St. Joseph near Norton
 Beisiegel John, house St. Joseph n. Norton
 Beiter Elizabeth, widow, house 34 Catharine
 Beiter Euseb, brewer, Hudson c. Channing, house Channing n. Hudson
 Beiter John, scroll sawyer, bds. 34 Catharine
 Belden Amos, photographer, 18 West Main, bds. 150 Alexander
 Belden Caroline E. widow, h. 150 Alexander
 Belden Hattie W. clerk, bds. 57 North av.
 Belden Janette C. Mrs. house 57 North av.
 Belden Joseph J. merchant, b. 30 South av.
 Belden Louis, whitewasher, house 90 Front
 Belding Almon V. removed to Tonawanda
 Belding Emerson E. engineer, h. 230 North
 Belding Harriet, widow, bds. 15 Goodman
 Belding Homer, dentist, 45 E. Main, house 4 Joslyn park
 Belding Laurinda W. widow, h. 15 Goodman
 Belding Lorinda Mrs. removed to Tonawanda
 Belding Merritt J. fireman, N. Y. C. R. R. bds. 137 Hudson
 Belding Samuel C. salesman, h. 104 Tremont
 Belgrave Eliza, laundress, h. 5 Tonawanda
 Belisle John, driver, house 213 State
 Belknap George, brakeman, bds. 104 Scio
 Belknap George E. builder, h. 11 Cliff
 Belknap Isadora A. dressmaker, 11 Cliff, h. do.
 Belknap Mary, widow, boards 151 Jones
 Belknap William S. clerk, 25 East Main, h. 151 Jones
 Bell Alfred, house East avenue c. Goodman
 Bell David, carpenter, h. 135 Monroe av.
 Bell David S. carpenter, 3 Sycamore, house 13 Maple place
 Bell Eliza A. widow, b. 18 Kelly
 Bell Emma, teacher, Glenwood school, No. 7, bds. 1 Spencer
 Bell Frederick A. b. East av. cor. Goodman
 Bell George, carpenter, house Central park n. First avenue
 Bell Henry, painter, 14 Stone, bds. 32 do.
 Bell Henry, carpenter, house 38 Stillson
 Bell Herman, carpenter, house 20 Pryor
 Bell Hugh V. removed to Philadelphia
 Bell Jacob D. & Son (*W. G. Bell*), planing mill, Court street bridge, h. 1 Spencer
 Bell James H. painter, b. 110 Plymouth av.
 Bell John, carpenter 40 Jay, h. 35 Sherman
 Bell Mary F. Miss, boards 20 Spencer
 Bell Matilda, boards East av. cor. Alexander
 Bell Patrick, laborer, h. Field n. Pinnacle av.
 Bell Robert, civil engineer, b. 109 Caledonia avenue
 Bell Thomas, carpenter, 93 Exchange, house 109 Caledonia av. [Meigs]
 Bell Thomas, janitor, Smith's block, h. 44
 Bell Thomas, waiter, Clinton Hotel, bds. do.
 Bell Thomas E. pastor Frank st. church, h. 34 Lyell
 Bell William, carpenter, house 66 N. Union
 Bell William G. confectioner, 110 Plymouth avenue, house do. [151 $\frac{1}{2}$ South av.
 Bell William G. (*J. D. Bell & Son*), house

Bellamy Frank J. student, University of Rochester, b. 35 Howell [Joiner
 Bellamy Joseph W. machinist, 69 State, h. 82
 Beller Etterick, tailor, b. 5 North York
 Bellew Francis, house Lyell near Cameron
 Bellgrave Nelson, shoemaker, 2 Mumford, boards 2 Sophia [30 Ward
 Bellinger Thomas, clerk, 46 East Main, h.
 Bellinger Charles F. harnessmaker, 5 Market, b. 94 Chatham [h. 94 Chatham
 Bellinger John P. harnessmaker, 5 Market,
 Bellman Geo. shoemaker, 79 North Water, house 19 Rauber
 Bellow Austin, tea dealer, boards 9 Franklin
 Bellows James, house 59 Plymouth avenue
 Bellows Mary Mrs. house 59 Plymouth av.
 Bellows Sarah, widow, b. 262 North St. Paul
 Belmont Leopold, saloon, 130 East Main, b. 7 North avenue [n. Norton
 Belmont Louis, measurer, h. North Clinton
 Bem John, laborer, house 122 Wilder
 Bemmel Frederick, house 48 Ambrose
 Bemis Frank, policeman, City Hall, h. John corner R. R. [State, h. 21 Elizabeth
 Bemis Henry (*Bingham, Bemis & Rogers*), 87
 Bemis Samuel, house 21 Elizabeth
 Bemish Edward, machinist, boards 19 Grape
 Bemish Geo. T. clerk, b. 23 Buchan park
 Bemish Mary, widow, house 4 Clarissa
 Bemish Mary J. widow, h. 23 Buchan park
 Bemish Richard, deliverer, 104 West Main, boards 19 Grape [23 Buchan park
 Bemish Richard W. bookkeeper, 40 Allen, b. house 23 Grape
 Bemish Sarah, widow, house 19 Grape
 Bemish Samuel, tallyman, house 4 Clark
 Bemish William H. clerk, 74 Mill, boards 23 Buchan park [North Washington
 Bemus James E. agent, 93 State, boards 34
 Bend Samuel, freight deliverer, h. 49 Scio
 Bend Samuel T. clerk, boards 49 Scio
 Bender Charles, tailor, 28 $\frac{1}{2}$ East Main, house 14 McDonald av.
 Bender Charles, tailor, 14 Mumford, house 33 Vose [h. 51 Hamilton place
 Bender Henry & P. undertakers, 102 E. Main,
 Bender Philip (*H. & P. Bender*), house 72 South avenue [9 Caledonia av.
 Bendinger John, stone cutter, 22 West av. b.
 Bendinger Louis, stone cutter, 22 West av. house 92 West avenue
 Bendon George W. cutter, b. 50 William
 Bendon Joseph J. shoemaker, 87 N. Water, boards 50 William [50 William
 Bendon Ralph S. policeman, City Hall, h.
 Benedict Alman B. house 164 West avenue
 Benedict Anna M. widow, boards 204 Jay
 Benedict Clare A. agent, 44 Exchange, h. 31 North avenue [Atwater
 Benedict Edwin, engineer, h. Leopold cor.
 Benedict Elizabeth C. b. East avenue corner Alexander [n. Canal, h. 154 Fitzhugh
 Benedict Gilbert E. blind maker, Aqueduct
 Benedict Goold S. house 154 Fitzhugh
 Benedict Henry B. salesman, 46 Mill, house 10 Leopold [avenue, house do.
 Benedict James S. saloon, State c. Railroad

HENRY C. WISNER,

CRYSTAL BUD VASES, EPERGNES, ETC., No. 33 STATE STREET.

- Benedict Lucretia, widow, b. 164 West av.
 Benedict Lucy L. widow, h. 34 Plymouth av.
 Benedict Luther C. lawyer, 124 Powers' buildings, boards 164 West avenue
 Benedict Nehemiah W. principal Rochester Free Academy, boards 48 Chestnut
 Benedict Oliver M. lawyer, 47 Powers' bldgs. boards Osburn House
 Benedict William, fireman, Allen cor. North Washington
 Benford George T. physician, 24½ E. Main, boards Norton near North Clinton
 Benford Thomas (*Benford & Andrews*), 1 Aqueduct, h. Norton n. North Clinton
BENFORD & ANDREWS (*T. Benford and E. R. Andrews*), book binders and manufacturers, 1 Aqueduct.—*See opp. page 513*
 Bengel Henry, carpenter, house 4 Hollister
 Bengel William, carpenter, 154 N. Water, house 10 Hollister
 Benham William G. removed from city
 Benigna Sisteř Mary, teacher, Holy Family School, Jay cor. Ames, boards 265 Jay
 Benjamin C. Smith, local editor Evening Express, 23 W. Main, h. 129 Alexander
 Benjamin D. Smith, school, 15 Exchange, house do.
 Benjamin Eliza H. removed to Canandaigua
 Benjamin Francis, boot crimper, house 59½ Baden [boards 31 Stone
 Benjamin Frederick, boot crimper, 87 Front, Benjamin Marcus G. clerk, 89 E. Main, bds. 42 Franklin [Alexander
 Benjamin Phebe A. widow, b. Broadway n.
 Benjamin Reuben, turner, 3 Aqueduct, bds. 6 Chatham [h. 42 Franklin
 Benjamin Solomon M. toys, 89 East Main,
 Benner Charles (*Scherer & Benner*), boards 19 Thorn
 Benner Henry, laborer, house 19 Thorn
 Benner Jacob, wagonmaker, house White alley near Perkins [alley n. Perkins
 Benner Jacob jr. wagonmaker, boards White
 Benner Philip H. cabinetmaker, 7 North Water, boards 19 Thorn
 Bennett Aaron (*S. Bennett & Son*), boards Genesee river below lower falls
 Bennett Aaron G. patternmaker, 138 Mill, h. 3 Waverley place
 Bennett Albert (*Bennett & Barry*), house 4 Second n. Glenwood avenue
 Bennett Albert R. machinist, 138 Mill, h. 34 Trowbridge [Fulton avenue
 Bennett Albertus, gardener, house Locust n.
 Bennett Alonzo H. machinist, 187 W. Main, house 89 Bartlett [house do.
 Bennett Asahel M. physician, 49 North av.
 Bennett Charles B. boot treer, 55 Mill, h. 63 Lowell
 Bennett Charles E. salesman, 50 Mill, boards 44 North avenue
 Bennett Cyrus R. engineer, Erie Railway, h. 5 Eagle
 Bennett C. H. clerk, 104 East av. h. 94 do.
 Bennett Edmund M. bookkeeper, 163 Exchange, boards 146½ W. Main
 Bennett Elbert R. student, Roch. Theological Seminary, boards 10 Tracy park
 Bennett Emma M. music teacher, h. 29 Jay
 Bennett Frank, collarmaker, 129 State, bds. 3 Waverley place
 Bennett Frank E. machinist, Brown's race foot of Furnace, boards 89 Bartlett
 Bennett Franklin, shoemaker, 19 West avenue, house 13 Hill
 Bennett F. C. widow, boards 27 East avenue
 Bennett George E. grinder, 187 West Main, boards 10 West av.
 Bennett Harry L. removed from city
 Bennett Horace L. lawyer, 42 Arcade, house 31 Cherry
 Bennett Ira S. (*McGraw & Co.*), 73 Alexander, house at Tonawanda
 Bennett James H. salesman, house 146½ West Main [1 Martin
 Bennett James J. painter, 165 East Main, h.
 Bennett Joel B. lawyer, 198 West Main, h. East avenue near Goodman
 Bennett Judah, widow, boards 119 St. Joseph
 Bennett J. H. miller, Whitney Mills, boards 17 Frank [house 5 Franklin
 Bennett Lauren R. stable, rear 117 West Main,
 Bennett Lucinda, widow, house 95 Clifton
 Bennett Maria, widow, b. 176 Plymouth av.
 Bennett Martha J. boards 327 State
 Bennett Mary, widow, h. 15 Greenwood av.
 Bennett Mary H. teacher, Genesee School No. 4
 Bennett Nancy M. widow, bds. 49 North av.
 Bennett Reuben B. clerk, boards 29 Jay
DENNETT RICHARD, gas fitter, 8 Mumford, house 26 Smith.—*See page 643*
DENNETT SAMUEL & SON (*Aaron Bennett*), boat house, Genesee river, foot of McCracken, lower falls, house do.—*See page 647*
 Bennett Sarah L. clerk, h. 126 Lake av.
 Bennett Thomas, painter, 165 East Main, h. 15 Greenwood avenue [348 State
 Bennett William H. polisher, 136 Mill, house
 Bennett Wm. H. bookkeeper, Powers' banking house, h. 44 North av.
 Bennett William M. real estate, 42 Arcade, house 36 Meigs
DENNETT & BARRY (*A. Bennett and J. H. Barry*), lumber, 140 Lake avenue cor. Champion.—*See page 639*
 Bennetzen Benedix, dyer, 40 Mumford, bds. 33½ Spencer [33½ Spencer
 Bennetzen Nis, dyer, Mill cor. Platt, boards
 Bennigen Mary A. weaver, b. 21 Lyell
 Bennigen Rosanna, weaver, b. 21 Lyell
 Bennigen Sarah, domestic, 11 Smith
 Benns Wm. shoemaker, 114 West Main, h. do.
 Bensneider John, laborer, house 17 German
 Bensneider William, laborer, b. 17 German
 Benson Edward, shoemaker, 4 Allen, house 41 Atwater
 Benson George, removed to Brockport
 Benson George G. student, Roch. Theological Seminary, boards Trevor Hall
 Benson Martha E. widow, h. 29 N. Clinton
 Benson Richard, shoemaker, 4 Allen, house 150 Hunter
 Bent Samuel R. baggageman, N. Y. C. R. R. depot, house 29 Lancaster

Bentley David, tallyman, boards 10 West av.
 Bentley Frank A. bookkeeper, b. 30 Marshall
 Bentley George (*Bentley, Meyer & Southwick*),
 house 30 Marshall
 Bentley Henry M. painter, house 7 Fulton av.
 Bentley John, laborer, Erie R. R. shop, house
 8 Champlain
 Bentley John F. (*Hawley, Meyers & Co.*), 55
 State, boards 62 Andrews
 Bentley Mary A. widow, h. 51 Thompson
 Bentley, Meyer & Southwick (*G. Bentley, P.
 J. Meyer and T. T. Southwick*), saw mill,
 r. Mt. Hope av., opposite Comfort
 Bentley Sardius D. lawyer, 41 State, boards
 27 East avenue [bds. 27 East av.
 Bentley Uriah S. student, University of Roch.
 Bentley Walter L. stove jointer, h. 51 Thomp-
 son
 Benton Amanda Miss, bds 45 Marshall
 Benton Ann E. widow, boards 14 N. Union
 Benton Charles C. foreman, paper mills, h.
 99 Fulton avenue
 Benton Charles W., deceased Feb., 1876
 Benton George A. (*Benton & Dickinson*), bds.
 45 Scio
 Benton Henry, house 56 Fitzhugh
 Benton Louisa, widow, bds. 45 Marshall
 Benton Maria, widow, boards 35 Smith
 Benton Reuben P. deceased Nov. 1875
 Benton Sarah, boarding house, 3 South
 Benton Winifred, widow, bds. 6 Thompson
 Benton & Dickinson (*G. A. Benton and P.
 P. Dickinson*), lawyers, 84 Arcade
 Benz John G. tailor, house 189 North
 Benz William, baker, 102½ East av., bds. do.
 Berdel G. John, hackman, house 83 Reynolds
 Berdett Edwin E. removed to Syracuse
 Berg Andrew, saloon, 246 St. Joseph n. Clif-
 ford, house do.
 Berg Jacob, boiler maker, Brown cor. Jones,
 house 23 Whitney [Webster road
 Berg John, laborer, house Ackerman near
 Berg Joseph, clerk, 42 State, house do.
 Berg Morris, agent, 40 State, bds. Whitcomb
 House
 Bergen Anna V. bds. East av. cor. Alexander
 Bergen Bridget, vestmaker, b. 29 Broadway
 Berger Philip (*Laird & Berger*), hair dresser,
 1 Corinthian Hall building, h. 13 Asylum
 Berger, see Burger [cor. Magnolia
 Bergh Frederick, carpenter, house Seward
 Bergh Henry, laborer, house 37 Oakman
 Bergh Minnie C. teacher, Seward School No.
 19, boards Seward corner Magnolia
 Berghardt Edward H. boards 2 Frank
 Berghaus Fred. clerk, 38 East Main, h. 224
 West Main
 Bergmann August, laborer, h. r. 27 Vienna
 Bergmann John N. builder, house 9 Henry
 Bergmann Philip, clerk, 228 W. Main, b. do.
 Bergmiller Martin, cigarmaker, b. 53 Ontario
 Bergmiller Paul, gardener, house 53 Ontario
 Berkel Anthony, carver, 71 N. St. Paul, bds.
 40 Buchan park
 Berkel Elizabeth, widow, h. 40 Buchan park
 Berlinghoff, Jacob, tailor, house 40 Walnut
 Berman Charles, traveling agent, boards 130
 St. Joseph

Berman Isaac, peddler, house 14 Pryor
 Berman Moses, peddler, house 130 St. Joseph
 Berna John, mason, house 23 Orange
 Berna Nicholas F. cigar maker, 106 Allen,
 boards 23 Orange
 Bernbom Abram, removed from city
 Berncka Frank, laborer, h. Campbell n. Ames
 Berndt August, painter, h. 19 Wadsworth
 Bernhard Adam (*Bernhard & Son*), 80 Lyell,
 house do. [boards do.
 Bernhard Charles (*Bernhard & Son*), 80 Lyell,
 Bernhard Frederick, machinist, b. 80 Lyell/
 Bernhard George, machinist, 129 Mill, bds.
 171 N. St. Paul [h. 38 Galusha
 Bernhard Otto, beer peddler, 139 N. St. Paul,
 Bernhard & Son (*A. & C. Bernhard*), grocers,
 80 Lyell [Factory, b. 103½ E. Main
 Bernhardt Edward, shipping clerk, Mill cor.
 Bernhardt George, machinist, boards 171 N.
 St. Paul [boards 1 Nassau
 Berns Frederick, trunkmaker, foot Rowe,
 Berry Charles, laborer, boards 5 Orange
 Berry Dell, plumber, house 2 Mumford
 Berry Frank, turner, boards 3 Orange
 Berry Jacob, machinist, Brown corner Jones,
 house 5 Orange
 Berry John H. laborer, bds. Waverley place
 Berry Theodore W. butcher, 70 Jay, bds. do.
 Berry William, laborer, house 36 Munger
 Berthold Lawrence, tailor, h. 35 McDonald
 avenue
 Berthold Valentine, carpenter, h. 12 Hope
 Berthold, see Barthold
 Berthrong Ithamar P. clerk, bds. 25 Adams
 Bertoni John, fruit stand, house 16 Jackson
 Bertram Geo. saloon, 229 N. Clinton, h. do.
 Bertram Jacob, laborer, boards 2 Pryor
 Bertram Philip, tailor, house 2 Pryor
 Bertrue Francois, miller, Frankfort Mills,
 house 158 North St. Paul
 Bertsch Adam, cooper, house 60 Hanover
 Bertsch Geo. M. tool temperer, 136 Mill, bds.
 60 Hanover
 Berwind George L. tailor, h. 9 Buchan park
 Besh Sister Remigia, St. Bonifacius school,
 boards 3 Grand
 Besline Conrad, house Childs opp. Orange
 Bessel Michael, shoemaker, house Colvin n.
 W. Maple
 Best John P. clerk, 62 State, house 13 Vine
 Bestard Anne, domestic, 41 Frank
 Bestard Harry B. engineer, h. Buell avenue
 Beth Henry, laborer, h. av. C. n. Harris av.
 Beth Joseph, laborer, bds. av. C. n. Harris av.
 Betteridge Carrie Miss, teacher, b. 20 Stillson
 Betteridge James E. clerk, 45 Andrews, bds.
 20 Stillson
 Betteridge Martha, widow, house 20 Stillson
 Bettner Thomas, blacksmith, 11 Mt. Hope
 av. house 21 do.
 Betts John W. bookkeeper, b. 26 Monroe av.
 Bettys Livonia, house 114½ East Main
 Bettys Louisa S. clerk, 7 E. Main, bds. 114½
 East Main
 Bettys Miranda, removed to Penfield
 Betz Valentine, teacher, house Laburnum n.
 Monroe av.
 Beuckman Barney, safe maker, bds. 9 Pryor

- Beuckman Henry, safe maker, house 9 Pryor
 Beven William, mason, house 12 Seward
 Bevan William, miller, Ely Mills, boards 274
 State [Lake avenue
 Bevier Andrew J. clerk, 136 State, boards 58
 BeVier Orville D. clerk, 14 Exchange, house
 28 Upton park
 Beye Leonard, hairdresser, Whitcomb House,
 boards Goodman corner Park avenue
 Beye Martin, carpenter, Minerva alley, house
 Goodman corner Park avenue
 Beyer Conrad, removed to Canada
 Beyer Peter, teamster, house 117 Broadway
 Beyerlein Henry, shoemaker, 18 Olean, h. do.
 Beyhan Dennis, hackman, h. 3 Thompson
 Bezenah Mary J. widow, bds. 56 Thompson
 Bickel Jacob, hostler, 159 State, b. 102 Front
 Bickel John, baker, 207 N. Clinton, h. do.
 Bickford Albert L. removed from city
 Bickford James jr. druggist, 208 E. Main, h.
 3 S. Union
 Bickley Thomas D. cutter, 14 Market, house
 3 Evergreen park [n. Goodman
 Bickman John, coachman, bds. East avenue
 Bicknell Abigail P. widow, house 17 Spring
 Biden Honoria, widow, house 4 Tremont
 Bidlack Benjamin, carriage maker, 3 Eliza-
 beth, house 70 Orchard
 Bidlack Betsey, widow, house 83 Orchard
 Bidlack Charles H. machinist, foot Platt, b.
 70 Orchard
 Bidlack Henry H. wood worker, Elizabeth
 corner Hill, b. 83 Orchard
 Bidlack Sarah Jane Miss, seamstress, boards
 83 Orchard [boards 1 Jones
 Bidwell Charles H. hay market, 79 Front,
 Bidwell Mary E. widow, house 1 Canal
 Bidwell Nathan D. removed to Jordan [h. do.
 Bieber Charles, cigar manuf. 53 N. Clinton,
 Bieck Anthony, boots and shoes, 199½ N.
 Clinton, house do.
 Bieck George, tailor, bds. 264 N. Clinton
 Bieck Martin, driver, South Water near E.
 Main, house 39 Scrantom
 Bieck Phillip, mason, house 264 N. Clinton
 Biedenbach Morris, carpenter, house 18 Bond
 Biedenbach Nicholas, plasterer, house Maria
 n. Clifford
 Bieger John, laborer, h. Thomas n. Clifford
 Biegler Charles. A. clerk, 73 E. Main, bds. 59
 Fitzhugh
 Biegler Henry, laborer, 142 Lake av. house
 11 Brisbane [Webster road
 Biegler Johanna, widow, h. Ackerman near
 Biegler Joseph A. physician, 16 N. St. Paul,
 house do. [16, bds. 59 Fitzhugh
 Biegler Mary E. teacher, Hudson School No.
 Biehler Charles J. salesman, 80 E. Main, bds.
 294 St. Joseph [Joseph
 Biehler Christopher, laborer, house 294 St.
 Biehler John, currier, h. Colvin n. W. Maple
 Biehler Lewis, cigar maker, 48 Exchange,
 boards 294 St. Joseph
 Biel Anthony, grocer, 116 Pinnacle av. h. do.
 Biel Christopher B. sash maker, 13 Ware-
 house, boards 116 Pinnacle avenue
 Biemer Herman, carpenter, h. 45 Andrews
 Bien Fred, gardener, boards 3 Herman
 Biener George H. cabinet maker, 184 State,
 boards 50 S. St. Paul
 Biener Henry, laborer, boards 48 Herman
 Biener Michael, cabinet maker, 184 State,
 boards 48 Herman
 Biener Wendlen, laborer, house 48 Herman
 Bierbroer Joseph, shoemaker, h. 82 Wilder
 Bierbruer Barbara Mrs. house Campbell cor.
 Orchard
 Bierbruer Philip J. shoemaker, 44 Exchange,
 bds. Campbell cor. Orchard
 Bierl John, blacksmith, Brown cor. Jones,
 h. 119 Orange [N. Water, b. 119 Orange
 Bierl Michael J. shoemaker, Andrews cor.
 Biesenbach John, foreman, h. 77 S. Union
 Bietry Mary, widow, house 32 Marshall
 Bigelow Abner P. bookkeeper, 19 Ware-
 house, bds. 16 S. Clinton [Spencer
 Bigelow Albert S. foreman, 8 White, h. 32
 Bigelow Electa P. widow, bds. Lorimer cor.
 Frank
 Bigelow John, butcher, h. 69 Orchard
 Bigelow Lewis, bookkeeper, Traders' Nat.
 Bank 35 West Main, bds. 29 Plymouth
 avenue [olis, Ind.
 Bigelow May Miss, removed to Indianap-
 Bigelow Myron T. carriage trimmer, 1 Lan-
 caster, house 28 Kirk
 Bigelow Paine Mrs. widow, b. 16 S. Clinton
 Bigford S. C. removed to Canada [bds. do.
 Biggs Charles, driver, 19 S. Washington,
 Biggs Louis A. removed to Washington, D.C.
 Bilger Anton, beer peddler, 106 Lake av. h
 rear 104 do.
 Bilger Mary, widow, house 28 Campbell
 Bilger Wilhelmina, widow, h. Webster road
 near Bay [h. 9 Stillson
 Billingham William, gunsmith, 41 E. Main,
 Billings Asa H. clerk, house 219 Monroe av.
 Billings Charles E. clerk, Exchange cor. W.
 Main, boards 146½ W. Main
 Billings Charles J. paver, house 11 Victoria
 Billings Curtis H. clerk, Post Office, bds. 2
 Edinburgh Court [roe avenue
 Billings Ellsworth, salesman, bds. 219 Mon-
 Billings Elton G., Erie Railway ticket office
 4 State, house 12 Charlotte
 Billings Jonas G. salesman, 69 E. Main, h.
 4 James
 Billings Oscar L. teacher, 3 Mortimer, h. do.
 Bills Elliott, porter, bds. 134 Jones
 Bills Francis, house North av. cor. E. Main
 Bills Fred. L. butcher, bds. 134 Jones
 Bills Marvin C. painter, house 134 Jones
 Bills Monroe E. produce dealer, h. 13 Weld
 Bills Nathan H. blacksmith, 3 Canal, b. 14 do.
 Bim Charles, laborer, house 9 Wait [h. do.
 Binder Julius, piano fortes, 3 Mumford,
 Binder Julius jr. (Shipman & Binder) 111 N.
 Water, boards 3 Mumford
 Bindnagel Valentine, stone cutter, 22 West
 av. house 82 Champlain
 Bing George, bird dealer, 2 S. Clinton, house
 N. Union corner Lewis [South av.
 Bingemer Albert F. carrier, Post office, h. 5
 Bingemer Anthony, h. 3 Mt. Hope avenue
 Bingemer Herman, carpenter, boards 3 Mt.
 Hope avenue

- Bingham, Bemis & Rogers (*W. M. Bingham, H. Bemis and S. J. Rogers*), stoves, &c., 57 State
- Bingham Frederick N. clerk, 67 E. Main, boards 75 do.
- Bingham George E. box maker, h. 67 Cady
- Bingham Homer E. painter, bds. 7 Wait
- Bingham Kleber, painter, h. 7 Wait
- Bingham Kleber, W. saloon, 9 Hunter, h. do.
- Bingham Robert, plane maker, 136 Mill, house 22 West Maple [32 Litchfield
- Bingham William, foreman, 4 Allen, house
- Bingham William A. boards 8 Clifton
- Bingham William J. shoemaker, 27 Wal-bridge's block, house 10 Litchfield
- Bingham William M. (*Bingham, Bemis & Rogers*), 57 State, house 8 Clifton
- Binke Martin, removed to Germany
- Binnard James, removed to Auburn
- Binney Omer, lawyer, 129 Powers' bldgs. house 52 Lake avenue
- Binsack Frank, mason, house 145 W. Maple
- Binswanger Samuel, clerk, 40 State, boards 31 Hanover
- Birch Walter, actor, Opera House
- Bird John, gardener, bds. Frank c. Lorimer
- Bird John H. overseer, at House of Refuge, house 22 Emerson
- Bird Samuel, fur cutter, h. 19 Anson park
- Birdsall Dellhemeia, shirt manufacturer, 141 Powers' bldgs. bds. 13 N. St. Paul
- Birdsall Theron M. decorator, h. 16 Wilder
- Birkholz Wendel, house 76 Chatham [Strong
- Birmingham John, blacksmith, house 41
- Birmingham John, laborer, h. 2 Edinburgh
- Birmingham John J. physician, 183 Powers' buildings, boards 72 Monroe avenue
- Bisbee Edward, shoemaker, 111 State, bds. 16 Allen
- Bisbee Henry, clerk, 132 State, b. 70 Clifton
- Bischoff Louis, laborer, house 32 Holland
- Bisgood John, assistant engineer Erie canal, 153 Powers' buildings, bds. 180 State
- Bisher John, laborer, 140 Lake av. h. 7 Champion
- Bishop Andrew, fireman, boards 78 Lyell
- BISHOP EDWIN A.** painter, 12 Stone, B house 7 Manhattan.—*See page 644*
- Bishop Frank B. (*Goodwin & Bishop*), 109 State, boards 4 Fitzhugh [Main
- Bishop Geo. painter, 14 Stone, b. 107½ East
- Bishop George H. painter, bds. 7 Manhattan
- Bishop John, laborer, boards 8 Vose [h. do.
- Bishop John H. clothing cleaner, 66 Adams,
- Bishop John H. student, 61 Powers' bldgs. bds. 7 Lorimer [ton Mill, h. 29 Orange
- Bishop Joseph H. machinist, Rochester Cot-
- Bishop Nathan, machinist, Rochester Cot-ton Mill, ft. Centre, house 27 St. Joseph
- Bishop Rebecca, bds. East av. cor. Alexander
- Bishop Richard W. paver, bds. 32 Brown's alley [126 Fitzhugh
- Bishop Robert, clerk, 73 East Main, boards
- Bishop Wilbur L. clerk, bds. 133 Monroe av.
- Bisnett Adolphus, boatman, bds. Rapids road near river [river
- Bisnett James, boatman, h. Rapids road near
- Bisnett Susan, widow, h. Rapids road n. river
- Bisordi Julian, plaster paris worker, bds. 11 Hill [168 Jay
- Bissell Alba S. machinist, Mill c. Factory, b.
- Bissell Artemas, lawyer, 81 Powers' bldgs. b. 140 Alexander
- Bissell Caroline, widow, house 168 Jay
- Bissell Daniel F. agent, 94 E. Main, h. 136 Plymouth avenue
- Bissell Edward H. removed to Richmond, Va.
- Bissell Josiah W. merchant, h. 48 Marshall
- Bissell Julia M. Mrs. house 48 Marshall
- Bissing John H. cooper, b. Childs n. Lime
- Biteley David B. blacksmith, 3 Canal, h. 200 West avenue
- Bitner Frederick, mason, house 28 Hebard
- Bittiger Augustus, moulder, 8 Hill, house 36 Grand
- Bittiger Bernard, moulder, 8 Hill, h. 34½ Grand [73 Mt. Hope av.
- Bittiger Louis, moulder, 187 W. Main, house
- Bittiger Mary, widow, house 36 Grand
- Bittner Adelia, widow, bds. 21 Mt. Hope av.
- Bittner Thomas B. blacksmith, 11 Mt. Hope avenue, h. 21 do.
- Black Ann, widow, house 24 N. St. Paul
- Black Charles J. salesman, b. 24 N. St. Paul
- Black David, salesman, 53 East Main, b. 24 North St. Paul
- Black Edmond E. agent, house 32 Sherman
- Black Henry, blacksmith, boards 50 Jay
- Black John, house 10 King
- Black John A. salesman, h. 13½ East av.
- Black John L. laborer, house 76 Myrtle
- Black Joseph, cisternmaker, 16 King, h. do.
- Black J. Franklin, clerk, 43 Exchange, h. 134 E. Main
- Black Mary W. Mrs. boarding, house 13½ East avenue
- Black Robert, laborer, h. Otis n. Sherman
- Black Sarah A. stitcher, boards 35 Smith
- Black Thomas J. finisher, 73 State, bds. 10 King
- Black William, removed from city
- Blackall Burton F. supt. fire alarm telegraph, 63 Front, house 42 North Union
- Blackall Mary, removed to Racine, Wis.
- Blackburn Lowry, car driver, b. 188 W. Main
- Blackburn Sarah, house 16 Spring
- Blackford Edward, house 121 East avenue
- Blackford Edward jr. house 121 East av.
- Blackford Samuel Mrs. widow, house 117 Plymouth avenue
- Blackman Anne Mrs. widow. h. 12 Elizabeth
- Blackman Elijah, millwright, house 33 Platt
- Blackman Nettie, lambrequin maker, 184 State, bds. 33 Platt
- Blackman Thomas, carpenter, 5 Penn, h. do.
- Blackmer Sarah Miss, removed to Sodus
- Blackmore Wm. H. foreman, h. 83 Joiner
- Blackwell Diana, widow, h. 124 S. St. Paul
- Blackwell John E. broommaker, bds. 124 S. St. Paul
- Blackwell Spencer S. W. salesman, 93 State, house near Albion [avenue
- Blackwood Henry D. painter, house 55 Frost
- Blackwood James, machinist, house 20½ Warehouse [Kent
- Blair Benjamin S. clerk, 36 State, boards 8

Blair Charles R. clerk, 53 E. Main, boards
32 Greig
Blair Mary J. Mrs. widow, house 82 Lyell
Blair Robert, salesman, house 32 Greig
Blake Ann, widow, boards 37 Lyell
Blake Ann Miss, house 52 Jones
Blake James, baker, house Plymouth av. c.
Spring
Blake Thomas, teamster, bds. 143 E. Main
Blake William H. miller, Frankfort Mills,
house 143 Jones
Blakeley Joseph, plumber, 96 East Main, h.
65 Gregory [Julia
Blakely Albert B. brakeman, b. Atkinson c.
Blakely James, mason, house Atkinson cor.
Julia [cor. Julia
Blakely John H. baggageman, b. Atkinson
Blakely Mary E. domestic, b. 5 Gibbs
Blakely William, brakeman, bds. Atkinson
corner Julia
Blakeney Isaac W. carpenter, Jefferson pk.
and (W. J. Blakeney & Co.), h. 6 Hamil-
ton place
Blakeney Mary J. widow, bds. 58 Hickory
Blakeney Samuel E. carpenter, house 159
South avenue
**BLAKENEY WILLIAM J. & CO. (I. W.
Blakeney)** cigar box manufs. 3 Aqueduct,
bds. 53 Atkinson.—See page 564.
Blanchard Eugene R. removed from city
Blanchard Lavira, widow, house 40 Platt
Blanchard Phila, b. East av. c. Alexander
Blanche John B. assistant pastor St. Joseph's
church, bds. 24 Franklin
Blanche Sister, teacher, bds. Jay cor. Frank
Blank Lucas, laborer, N. Y. C. depot, bds.
122 Front
Blank Max, mason, boards 94 N. Clinton
Blasi Elizabeth, widow, house 3 Herman
Blasi Jacob, cabinetmaker, bds. 3 Herman
Blasi Philip, cabinetmaker, bds. 3 Herman
Blasy Frederick, salesman, h. Bay n. Hebard
Blasy John, saloon, Weeger c. Henry, h. do.
Blattner Clement, cabinetmaker, 71 N. St.
Paul, bds. 94 N. Clinton
Blauw Ernestine, widow, h. 69 N. Clinton
Blauw Frederick, clerk, bds. 69 N. Clinton
Blazey Charles F. gardener, house 20 Wilson
Blazey Charles F. removed to Victor
Blazey John, removed to Victor
Blazo Alfred M. removed from city
Blazo Benjamin K. shoemaker, 4 Allen, h.
27 Clifton [Huron near Scio
Bleau George, shoemaker, 91 N. Water, h.
Bleier John, carpenter, house 3 Maria
Blekken John H. watchman, h. 2½ Vose
Blencoe Hannah Miss, bds. 89 Monroe av.
Blencoe Lucy A. widow, bds. 89 Monroe av.
Blennerhassett Robt. teacher, h. 56 Broadway
Blene Margaret, bds. Campbell n. Ames
Blene Peter, laborer, h. Campbell n. Ames
Blesser Albert, Roch. Opera House, bds. 4
Stillson
Blesser Caroline, millinery, 129 E. Main, h.
191 N. Clinton [Stillson
Blesser Charles A. Roch. Opera House, b. 4
Blesser George W. shoemaker, 92 State, h.
14 Joiner

Blesser Mary Ann, widow, h. 4 Stillson
Blessington Mary, cook, Congress Hall, b. do.
Bletzer Anna, shoemaker, bds. 73 W. Maple
Bletzer John, tanner, 87 N. Water, h. 92 W.
Maple
Bletzer Margaret, shoemaker, h. 73 W. Maple
Blauenstein John, harnessmaker, 244 E. Main,
bds. do. [25 E. Maple
Bley William, coach trimmer, 3 Canal, h.
Blim Sarah, seamstress, 6 Wilder, b. 1 Grape
Bliss Charles, stonemason, h. 100 North av.
Bliss Chester T. physician, bds. 33 Spring
Bliss James, boards 66 Exchange
Bliss John, peddler, house 36 Hollister
Bliss Mary I. Miss, young ladies' school, 33
Spring, house do.
Bloch Leopold (Stein, Adler & Co.), 14 Mum-
ford, boards 12 Gibbs
BLOCK PHILIP, mason and builder, h.
111 South avenue.—See page 641
Blodgett Isaac C. salesman, 36 Exchange, h.
at Batavia
Blondeau Adolph, engraver, bds. 2 Chestnut
Blondeau Auphinee Miss, dressmaker, 6½
Fitzhugh, house do. [do.
Blondeau Gaston, scouring, 2 Chestnut, h.
Blondon Ann Mrs. house 11 Ely
Bloom Joseph I. clerk, 75 East Main, boards
47 Clinton place [Joiner
Bloss Charles, shoemaker, 4 Allen, house 65
Bloss John T. peddler, 144 East Main
Bloss Joseph B. (G. C. Buell & Co.), 36 Ex-
change, house 28 East av.
Bloss Mary A. widow, boards 7 George
Bloss Wm. C. Mrs. widow, bds. 28 East av.
Bloss William W. clerk, boards 28 East av.
Blosser W. F. salesman, 65 W. Main, house
at Lockport
Blossom George D. boards 160 Exchange
Blossom Thomas M. foreman, h. 68 South av.
Blott John, butcher, house 2 North Ford
Bloxsom Albert H. hairdresser, 5 Exchange,
boards 30 Caledonia av.
BLOXSOM AUGUSTUS C. hairdresser,
and cigar dealer, 319 State, h. do.—See
pages 564 and 568
Bloxsom Josiah H. hairdresser, 2 Railroad
avenue, house 38 Pinnacle avenue
Blum Albert, moulder, house 16 Tonawanda
Blum Anthony, agent, 47 Mill, bds. Whit-
comb House
Blum Anton, laborer, house 84 Orange
Blum Caroline, stitcher, boards West Maple
corner Ames
Blum Catharine, spooler, boards 84 Orange
Blum Charles, salesman, Mill cor. Mumford,
boards 3 Atwater
Blum Delia, saleswoman, boards 3 Atwater
Blum George, moulder, 187 W. Main, house
Ames near West Maple
Blum Hannah, saleswoman, bds. 3 Atwater
Blum Henry, bookbinder, 27 Smith's block,
house West Maple corner Ames
Blum John, cabinetmaker, Jay corner Erie
Canal, boards 84 Orange
Blum Joseph, mason, house Hollenbeck
Blum Lantie, widow, h. W. Maple cor. Ames
Blum Leopold, salesman, house 3 Atwater

Blum Louis, carpenter, 21 Pryor, house do.
 Blum William, blindmaker, 13 Warehouse
 Blume John, laborer, house 8 Putnam
 Blumenstiel Alexander, cutter, 14 Mumford,
 boards 13 Davis
 Blumenstiel Louis, removed to Chicago, Ill.
 Blumenstiel Moses, produce dealer, house
 13 Davis [park
 Blumer Rudolph, machinist, h. 31 Buchan
 Blumer Rudolph jr. upholsterer, boards 31
 Buchan park [Martin
 Bluntach Alexander, clerk, 42 State, house 29
 Blust Henry, shoemaker, h. 233 N. Clinton
 Bly Douglass, deceased May 10, 1876 [av.
 Bly Douglass Mrs. widow, h. 45 Plymouth
 Blyth Eduardo E. teller, Mechanics' Savings
 Bank, 15 Exchange, b. European Hotel
 Blyth Elijah K. house 34 North av. [bldgs.
 Board of Fire Underwriters, 130 Powers'
 Boardman Charles, sawyer, boards Sibley n.
 Culver
 Boardman Emily Miss, boards Oakland
 Boardman George B. (*J. McKillop, & Co.*),
 6 State, house 116 Fitzhugh
 Boardman Henry E. house Monroe av. near
 Goodman
 Boardman Herbert, deceased Dec. 1875
 Boardman John H. (*S. Boardman & Co.*), h.
 at Brighton [av. n. Goodman
 Boardman Lydia A. widow, boards Monroe
 Boardman Silas & Co. (*J. H. Boardman*),
 seedsmen, Minerva alley, h. at Brighton
 Boardman Wm. E. miller, Flour City Mills,
 Boardwell Mary Miss, bds. 22 N. St. Paul
 Boas Chas. W. cigarmaker, h. Mansion n. Flint
 Boas Louis, baker, Brown cor. West Maple,
 boards Railroad alley near railroad
 Boas Walter, laborer, boards 3 Stone
 Boast Geo. carpenter, h. 243 Plymouth av.
 Bock Charles, finisher, 7 North Water, bds.
 40 Colvin
 Bock Conrad, shoemaker, 43 North av. h. do.
 Bock George, laborer, house 40 Colvin
 Bock George, grinder, h. 161 Pinnacle av.
 Bock Gustav, (*A. Vetter & Co.*), cabinetmaker,
 149 N. Water, house 85 Mt. Hope av.
 Bock G. Henry, tailor, 1 South Water, bds.
 East Main near Goodman [26 Kirk
 Boddy Alfred J. lastmaker, 123 Mill, boards
 Boddy Charles, lastmaker, 123 Mill, house 11
 Joslyn park [block
 Boddy Delia Mrs. seamstress, h. 66 Sibley's
 Boddy Henry W. lastmaker, 123 Mill, bds.
 26 Kirk [30 Asylum
 Boddy John W. grocer, 210 East Main, h.
 Boddy Thomas, lastmaker, 123 Mill, house
 26 Kirk
 Boddy Thomas jr. last manufacturer, 123
 Mill, house 23 Concord avenue
 Boden Abram, watchmaker, Court c. Stone,
 house 18 Pearl
 Bodenstein George, house Miller near Bay
 Bodenstein John, butcher, h. Ashland near
 Gregory
 Bodenstein John, clerk, 56 Spring, bds. do.
 Bodle Richard, machinist, bds. 13 East av.
 Boehler Albert, safemaker, 188 State, house
 Alphonse near Henry

Boehly Frank, tailor, house 16½ Clifford
 Boehly Frank jr. tailor, bds. 16½ Clifford
 Boehly George, removed to Webster
 Boehly Jacob, tailor, bds. 16½ Clifford
 Boehly Joseph F. trimmer, 68 Mill, house 14
 Clifford
 Boehly Michael, carpenter, bds. 16½ Clifford
 Boehm Christian, cigar manufacturer, 149
 St. Joseph, house do.
 Boehm John, saloon, North St. Paul corner
 Franklin, house do.
 Boehm John, brewer, Colvin cor. W. Maple,
 house 25 West Maple
 Boehm Louis, blacksmith, b. 125 W. Maple
 Boehm Mary, domestic, 12 Pleasant
 Boehringer Joseph, laborer, h. 157 Hudson
 Boemer John, polisher, 122 Mill, h. 23 Her-
 man
 Boeniek Henry, harnessmaker, 51 South St.
 Paul, boards 6 Widman
 Boerner August, finisher, 73 State, boards
 12½ Munger
 Boerner Frederick, musician, h. 12½ Munger
 Boerner Nicholas, tailor, boards 12½ Munger
 Boes Joseph, comb maker, house 11 Cole
 Boetcher Eliza, widow, h. Lewis c. Mt. Ver-
 non avenue [Sauers' park
 Boettcher Adolphus H. machinist, boards 4
 Boettcher Charles, varnisher, b. 4 Sauers' pk.
 Boettcher Frank W. upholsterer, 73 State, b.
 4 Sauers' pk. [house 23 Kelly
 Boettcher Frederick W. J. A. cutter, 68 Mill,
 Boeyink Christian, carpenter, Minerva alley,
 house 9 Wadsworth
 Boeyink John, carpenter, bds. 141 Hudson
 Bogardus Nettie, widow, house 33 Hill
 Bogart Agnes, widow, house 17 Hoeltzer
 Bogen Alice C. teacher, Wadsworth School,
 No. 12, b. 4 N. Washington
 Bogenschutz August, mason, house 22 Hill
 Bogner Ferdinand, blacksmith, Brown's race
 corner Furnace, house 110 Hudson
 Bogner John, shoemaker, 44 Exchange, h.
 Strong corner Reynolds [110 Hudson
 Bogner Louis, engineer, 31 Exchange, boards
 Bohan Wm. chair finisher, 184 State, boards
 Engine house No. 4, S. Ford [canal
 Bohlen Bridget, widow, h. Trowbridge n. Erie
 Bohlen John, stonecutter, 22 West avenue, h.
 Trowbridge near Erie canal
 Bohlen Michael, cigar maker, 178 W. Main,
 boards Trowbridge near Erie canal
 Bohlen William, yardman, Clarissa opp. Ex-
 change, house 151 Champlain
 Bohle Constance, house 24 Hoeltzer
 Bohle Henry, removed from city
 Bohle Joseph F. laborer, house 30 Buchan pk.
 Bohm Barbara Miss, house 34 N. Union
 Bohm Ernst, laborer, 87 North Water, house
 45 Hoeltzer
 Bohm Frederick, laborer, house Ulm n. Bay
 Bohm Joachim, laborer, house 28 Weeger
 Bohnter John, h. Diem near Lewis
 Bohrer Conrad, painter, house 37 Campbell
 Bohrer Louis, removed to Osage city, Kan.
 Bohrer Louis, grocer, 102 North av. h. do.
 Bohrer Peter, policeman, City Hall, house 5
 Kirk

Bohrer Philip, painter, boards 37 Campbell
 Bohrer Simon, cigarmaker, 91 Chatham, h.
 32 Hudson
 Bohrer Xavier, chairbottomer, 5 Weld, h. do.
 Boland Catherine, widow, house 49 Hunter
 Boland Maggie, domestic, 16 Canal
 Boland Martin, carpenter, 111½ N. Water,
 boards 61 Lime
 Boland Mary Miss, tailoress, bds. 49 Hunter
 Boldt William, laborer, house Lewis
 Bolender William, removed from city
 Bolger James C. stavecutter, b. 87 Whitney
 Bolger John, laborer, house 87 Whitney
 Boll John, painter, boards 3 Costar
 Boll Magdalene, widow, house 3 Costar
 Bollenbach John, janitor, bds. 99 Front
 Boller John K. salesman, 66 E. Main, house
 35 Ontario
 Bolles Elisha T. boards 101 West avenue
 Bolles R. Gertrude, teacher, Madison Park
 School No. 2, boards 19 Clifton
 Bolt Chas. mason, boards 8 Henry
 Bolt Christian, laborer, house 8 Henry
 Bolt Joachim, laborer, h. r. Hudson n. Berlin
 Bolton Thomas (*Phelan & Bolton*), Andrews
 cor. N. Water, house 10 Franklin sq.
 Bomberger —, boards 97½ E. Main
 Bonaventure Mary, teacher, boards Jay cor.
 Frank
 Bond Edward S. finisher, house 25 Olean
 Bond Everdt, painter, h. 5 Brighton avenue
 Bond Hannah O. widow, h. 10 Gregory
 Bond Hiram, deceased June, 1875
 Bond James, deceased March, 1876
 Bond John, mason, house 96 Clifton
 Bond John E. painter, 112 E. Main, house
 Brighton avenue n. Rowley
 Bond Matilda, widow, boards 56 Sophia
 Bond William H. bookkeeper, 15 N. Water,
 boards 25 Olean
 Bonhotal Fred. L. clerk, 83 E. Main, b. do.
 Bonke Henry, laborer, house 111 Chatham
 Bonnar David A. pastor, St. Clement's church,
 house Munger cor. Ashland
 Bonnaud Fernand, cook at Osburn House
 Bonner James W. driver, 104 Plymouth ave.
 house 19 Greig
 Bonnet H. Charles, baker, St. Patrick's Or-
 phan Asylum, Frank corner Vought
 Bonnet Françoise L. teacher, b. 5 Linden
 Bonter John V. clerk, h. 48 Tremont
 Bontiel Isaac, laborer, house 50 Gregory
 Bontiel John M. laborer, house Monroe ave.
 corner Meigs [Colvin
 Bonum Barbara, widow, h. W. Maple near
 Boogaard James, milkman, house Waring
 road n. Norton [Plank road, h. do.
 Book George, tavern, Bay corner Webster
 Boon William, engineer, house 13 Mortimer
BOONE THOMAS R. merchant tailor, 20
D West Main, house Lambert park.—
See page 543 [St. Joseph
 Boor Charles E. bookkeeper, 47 Mill, bds. 7
 Boor Francis, leather, 47 Mill, h. 7 St. Joseph
 Boor Frank, cooper, 232 Jay, house Childs n.
 W. Smith [Joseph
 Boor Frank W. clerk, 47 Mill, boards 7 St.
 Boor John, laborer, h. 148 Wilder

Boor Margaret, widow, house Jay n. Wack-
 erman [53 Broadway
 Boorman Edward H. wagonmaker, house
 Boorman Fred F. (*Pearl & Boorman*), 64
 West avenue, house 3 Clifton
 Boorman Friend, clerk, bds. 32 Tremont
 Boorman George, laborer, 3 Canal, h. 10
 Summer [Ont.
 Boorman James G. removed to North Ridge,
 Boorman Robert M. wagonmaker, Brown c.
 West avenue, h. 10 Summer
 Boos Frank, machinist, b. W. Maple n. Hague
 Boos James M. sawyer, b. W. Maple n. Hague
 Boos Joseph, baker, 45 Fitzhugh, h. West
 Maple near Hague
 Booth Cecilia E. Mrs. h. 210 Monroe av.
 Booth Charles M. jeweler, 5 State, house
 Culver near Webster road [ton
 Booth Cyrus B. clerk, 5 State, b. 21 N. Clin-
BOOTH EZRA B. & SON (*H. G. Booth*),
 watches, clocks and jewelry, 5 State, h.
 21 N. Clinton.—*See page 514*
 Booth Henry G. (*E. B. Booth & Son*), boards
 21 N. Clinton [b. 146½ W. Main
 Booth Henry W. hair dresser, 13 Exchange,
 Booth James E. (*Woodbury, Booth & Pryor*),
 138 Mill, house 43 Lake avenue
 Booth James J. salesman, house 21 Asylum
 Booth Jessie F. teacher, Wadsworth School,
 No. 12, b. 210 Monroe avenue [ander
 Booth Jonathan L. rail manuf. h. 137 Alex-
 booth Margaret, widow, h. 27 Lancaster
 Boothroyd Rowland, market, 33 North av.
 house do.
 Boppel Mary, widow, house 182 St. Joseph
 Borchart Frederick, nurseryman, h. Bor-
 chart near St. Joseph [ford
 Borg Peter, shoemaker, h. Thomas n. Clif-
BORNEMAN BROS. (*G. & J. C. Borne-*
B*man*), merchant tailors, 8 North Clinton.
 —*See page 537*
 Borneman George (*Borneman Bros.*), 8 North
 Clinton, house 3 Joiner
 Borneman John C. (*Borneman Bros.*), 8 North
 Clinton, house 32 Tappan
 Borneman Mary, milliner, 129 E. Main, bds.
 3 Joiner
 Bornkessel Andrew, carpenter, h. 105 Scio
 Bornkessel Christian J. grocer, 100 Scio, h. do.
 Borradaile Albert, pressman, 3 West Main,
 h. Kelly n. Hudson [do.
 Borradaile Bella, dressmaker, 39 Meigs, h.
 Borradaile Henry C. pressman, 3 West Main,
 house 14 Prospect
 Borradaile Lizzie, dressmaker, h. 39 Meigs
 Borradaile Sarah, deceased, July 24, 1875
 Borradaile Wm. C. painter, 14 Stone, boards
 Kelly near Hudson [Marietta
 Borst George, clerk, 40 Front, house 12
 Bortle Charles P. teamster, 65 N. Water, h.
 46 Delevan [house 5 King
 Bortle George P. paints, oils, &c., 50 West av.
 Bortle Martha A. Miss, principal, Bortle
 Seminary, Jay corner Magne, house do.
 Bortle Morris, turner, Aqueduct, house 22
 Marshall
 Bosch John, machinist, 138 Mill, h. 3 Kelly
 Bosche Adam, carriage painter, h. 144 Wilder

Bosche Albert, carriage painter, b. 144 Wilder
 Boschelsci Ferdinand, laborer, 151 N. Clinton
 Boschert John M. clerk, 3 West Main, b. 70
 North Clinton
 Bosely Wm. moulding sticker, 13 Warehouse,
 boards at Gates
 Bosley Alonzo, building mover, b. 77 North
 avenue
 Bosley Esther, widow, b. 77 North av.
 Bosold August, cooper, Magne opp. Walnut,
 house Jay near Ames
 Bosold Catharine, widow, h. Jay near Ames
 Bosold Henry, butcher, house 187 Jay
 Boss Abraham & Co. (*W. Zwick*), boots and
 shoes, 76 North avenue, house 100 do.
 Boss Geo. W. telegraph operator, 151 State,
 boards 58 Frank [cor. R. R.
 Boss Louis, baker, house Railroad alley
 Bosse Frank, laborer, house 30 Catharine
 Bosse Henry, draughtsman, boards 66 Weld
 Bosshardt Albert, servant, Osburn House
 Boston William jr. clerk, 7 S. St. Paul, b. do.
 Bostwick Albert S. (*Bostwick & Heindl*), 2
 East Main, house 15 Clifton [av.
 Bostwick Jane, dressmaker, h. 73 Caledonia
 Bostwick Lyman Mrs. house 15 Clifton
BOSTWICK & HEINDL (*A. S. Bostwick
 and L. Heindl*), printers, 2 East Main.—
See page 524
 Boswell Charles P. screw manuf. Furnace c.
 Mill, house East avenue corner Sibley
 Boswell Elizabeth, widow, h. 3 North Union
 Bosworth Charles C. printer, 67 Arcade, bds.
 • 146½ West Main [h. 47 Vick park
 Bosworth John H. salesman, 26 West Main,
 Bosworth Seth W. house 16 Glasgow
 Bosworth Willard H. clerk, b. 47 Vick park
 Bosworth William H. principal, Andrews
 School, No. 9, house 6 Atwater
 Botsford David, boards Waverly House
 Botsford Edmund M. student, 15 Powers'
 bldgs. boards 147 Frank
 Bott Adolph, tailor, 13 Hanover, house do.
 Bott August, tailor, house 57 North avenue
 Bott Caspar, cabinetmaker, Jay c. Erie canal,
 boards 37 Rauber
 Bott Caspar, tailor, house 149 Pinnacle av.
 Bott Ellen, widow, b. Ames n. West Maple
 Bott Johanna, tailoress, b. 149 Pinnacle av.
 Bott John A. boots and shoes, 246 State, h.
 109 Orchard [Weld
 Bottle Benjamin, waiter, Osburn House, h. 71
 Bottum Elijah, bookkeeper, Powers' Banking
 House, house 103 Fitzhugh [Fitzhugh
 Bottum Frank M. student, 8 State, bds. 103
 Bouch John, laborer, house 198 Scio
 Boucher Emery, miller, Washington Mills,
 h. 18 Lyell [b. 27 North Clinton
 Boucher James H. bookkeeper, 21 W. Main,
 Boughton Augusta, widow, bds. 54 Chestnut
 Boughton Anna, widow, house 20 Hickory
 Boughton Edward S. Mrs. widow, house 9
 Madison [line
 Boughton Geo. G. h. Mt. Hope av. near city
 Boughton John, carpenter, b. 1 Anderson av.
 Boughton Romeyn, clerk, b. 9 Madison
 Boughton Romeyn F. bookkeeper, 147 State,
 boards 9 Madison

Boughton Seymour (*H. C. Collins & Co.*), 2
 Plymouth avenue, house at Pittsford
 Bouman Michael, cutter, house 26 Bartlett
 Bour Caspar, cooper, house 228 Jay
 Bourbos Joseph, shoemaker, h. 48 Atwater
 Bourke Richard F. watchmaker, 18 State, h.
 75 Lake avenue
 Bourne John, carpenter, 178 North St. Paul
 Bouton Enoch, house 80 South St. Paul
 Bouyon Paul, confectioner, 83 E. Main, h.
 do. [av. boards 111 do.
 Bowans Adrian, umbrella repairer, 113 North
 Bowden Henry J. bookkeeper, 1 East park,
 house 25½ Meigs [av. D near N. St. Paul
 Bowden James, paper hanger, 15 Front, b.
 Bowden James, teamster, h. rear McCracken
 near Buell av.
 Bowden Simon, teamster, b. r. McCracken n.
 Buell avenue
 Bowen Adna (*Tucker & Bowen*), 19 Smith's
 block, house at Medina
 Bowen Ann L. widow, h. 4 Plymouth av.
 Bowen Augustus C. contractor, b. 41 William
 Bowen Carrie Miss, baker, boards 117 Adams
 Bowen Charles H. gardener, house 2 Bowen
 Bowen Clinton, teamster, Lower Falls, bds.
 Champion corner Fulton avenue
 Bowen John, machinist, boards 46 Frank
 Bowen John J. lawyer, house 41 William
 Bowen Julius C. physician, 20 Savannah,
 boards do.
 Bowen Laura S. widow, boards 17 Adams
 Bowen Margaret, widow, house 46 Frank
 Bowen, see Bohem
 Bower Caroline, widow, boards 358 Brown
 Bower Charles, blacksmith, 138 Mill, h. 358
 Brown [Ames
 Bower Godfrey, mason, h. West Maple near
 Bower John, house 21 Prince
 Bower William H. deceased Aug. 1875
 Bower, see Bauer
 Bowerman Daniel, engineer, house 56 Kent
 Bowers Henry, salesman, house 40 William
 Bowes John C. locksmith, bds. 17 Oregon
 Bowes Patrick, laborer, house 9 Kelly
 Bowes William A. machinist, 136 Mill, house
 17 Oregon [House
 Bowker John H. expressman, bds. Brackett
 Bowles Hills, teamster, house Ninth n. Erie
 canal
 Bowman Alexander C. tallyman, N. Y. C.
 freight office, Kent c. Platt, h. 226 Brown
 Bowman Benjamin, brick maker, house 74
 Pinnacle av. [Court, h. at Holley
 Bowman Charles A. salesman, Exchange c.
 Bowman George, blacksmith, Clifton corner
 Genesee, house do.
 Bowman H. Mary, married to Michael Keller
 Bowman Johanna E. seamstress, boards 74
 Pinnacle avenue
 Bowman John, hostler, 47 S. St. Paul, h. do.
 Bowman Lewis F. (*Bowman & Wick*), 90
 Plymouth avenue, house 16 Tremont
 Bowman Mabel, widow, boards 185 State
 Bowman Margaret, widow, house 78 Frances
 Bowman Rachel L. boarding house, 33 Fitz-
 hugh [bldgs. b. European Hotel
 Bowman William H. lawyer, 94 Powers'

Bowman & Wick (*L. F. Bowman and Charles Wick*), market, 90 Plymouth av.
 Bown Edwin A. blacksmith, 3 Canal, h. 128 Tremont [h. 53 Pinnacle av.
 Bownes Edward, paper hanger, 52 E. Main.
 Box Frank, tinsmith, 153 E. Main, b. 9 Cobb
 Box Louisa, widow, house 9 Cobb
 Box Margaret, widow, house 98 Broadway
 Boxall James, laborer, bds. 44 Brown's alley
 Boxaw James, laborer, Arcade, bds. 6 Smith
 Boyce George E. carpenter, 3 Sycamore, h. 43 William
 Boyce Henry, cigarmaker, b. 15 Chestnut pk.
 Boyce Isabella, widow, bds. 91 S. Union
 Boyce John, cigar manufacturer, house 15 Chestnut park
 Boyce Louis D. printer, h. 113 Monroe av.
 Boyce Mary A. Mrs. millinery, house 113 Monroe avenue
 Boyce Philip G. cigar maker, h. 37 Bolivar
 Boyd Armstrong, boards 130 Lake avenue
 Boyd Armstrong jr. teamster, paper mill, h. 130 Lake avenue
 Boyd Arthur, machinist, house 206 North
 Boyd Eliza Miss, boards 45 Franklin
 Boyd James, produce dealer, h. 41 Delevan
 Boyd James, teamster, house 9 Second near Rowe
 Boyd James jr. fish peddler, b. 41 Delevan
 Boyd James A. (*Dodge & Boyd*), 12 E. Main, house Monroe avenue near Goodman
 Boyd John, house Monroe av. n. Goodman
 Boyd John F. proprietor Lake Avenue Hotel, 159 Lake avenue [Clinton
 Boyd Robert (*Boyd & Tubbs*), house 7 South
 Boyd Robert G. carpenter, Saratoga avenue cor. Jones avenue, house do.
 Boyd William, clerk, bds. 7 South Clinton
 Boyd & Tubbs (*Robert Boyd and George L. Tubbs*), stoves, &c., 153 East Main
 Boyer George W. peddler, house 124 Frank
 Boyer James F. fish peddler, h. 181 Exchange
 Boylan Nicholas, saloon, 53 Lyell, house do.
 Boyle Ann, widow, house Scio near East av.
 Boyle Catharine, dressmaker, 168 State, bds. 38 Brown's alley [4] Erie
 Boyle Edward C. bookkeeper, 215 State, h.
 Boyle Frank, blacksmith, Exchange opposite Glasgow, house Exchange n. Edinburgh
 Boyle John, laborer, Frost av. cor. Olean, h. 137 Hunter
 Boyle Patrick, laborer, h. 38 Brown's alley
 Boyle Rebecca, widow, h. 172 Exchange
 Boyle Thomas, deceased Sept. 1875
 Boyle Thomas jr. deceased Feb. 1876
 Boyle William, nailmaker, house 17 Martin
 Boyle William, saloon, 8 Pine, house do.
 Boylen Bernard, teamster, bds. 137 Hunter
 Boylen George, laborer, boards 137 Hunter
 Boylen John, teamster, boards 137 Hunter
 Boylen Patrick, laborer, house 137 Hunter
 Boyles Frank, painter, 6 East av. h. 9 Asylum
 Brace George H. collector, 23 West Main, h. 140 University avenue
 Brace Sears P. house 20 South Washington
 Bracht Phillip G. tailor, house 9 Baden
 Bracken Bridget, widow, b. 6 Elizabeth place
 Bracken Fannie A. Miss, bds. 6 Woodbury

Brackett James, president Ontario Iron Co. 90 Mill, h. 36 Fitzhugh [244 State
 Brackley Alfred A. polisher, 122 Mill, boards
 Braddock William J. machinist, h. 4 Smith
 Braden Henry T. baker, house 42 South av.
 Brader Anthony, laborer, h. 159 St. Joseph
 Bradfield Alfred J. machinist, b. 38 Lorimer
 Bradfield John, miller, house 38 Lorimer
 Bradford George A. removed to Philadelphia
 Bradford Henry, coachman, 17 N. Washington, house 218 West Main
 Bradford John W. shoe fitter, 6 N. Water, house 14 Broadway
 Bradler Frank X. grocer, 16 Hanover, h. do.
 Bradley Almon, boards 15 Charlotte
 Bradley Alonzo, farmer, house Culver near Webster road
 Bradley Anna G. Mrs. house 180 State
 Bradley Ann J. Miss, b. 43 Hamilton place
 Bradley Cyrus, gunsmith, bds. 78 S. St. Paul
 Bradley David, hostler, house 57 Monroe av.
 Bradley Hugh, physician, 21 Oak, house do.
 Bradley John, bookkeeper, 24 State, house 43 Hamilton place
 Bradley John H. removed to Pennsylvania
 Bradley Joseph, carpenter, 3 Canal, house 27 West Maple [b. 43 Hamilton pl.
 Bradley Joseph H. watchmaker, 88 S. St. Paul,
 Bradley Mary Miss, dressmaker, boards 86 East Main
 Bradley Michael, laborer, h. 201 Monroe av.
 Bradley Patrick, driver, house Frost avenue near Frances
BRADLEY PETER B. photographic stock, 118 Front, h. 103 Lake av.—*See page 523*
 Bradley Sarah E. widow, h. 43 Hamilton pl.
 Bradley William, machinist, bds. 2 Sycamore
 Bradley William, painter, bds. 27 W. Maple
 Bradley Wm. T. gardener, b. 43 Hamilton pl.
 Bradley Wilson, painter, bds. 113½ E. Main
 Bradner A. H. (*Loverly & Bradner*), 23 North Water, house at Dansville
 Bradner Wm. finisher, 184 State, h. 8 Bower
 Bradshaw George, mason, h. 212 East Main
 Bradstreet Addison W. clerk, bds. 3 South
 Bradstreet Charles S. cutter, b. 44 N. St. Paul
 Bradstreet George H. clerk, 67 E. Main, bds. 44 North St. Paul [16 Troup
BRADSTREET, THE J. M. & SON COMPANY, improved mercantile agency, 28 and 30 Arcade, gen'l offices in N. Y.—*See front cover*
 Bradstreet Lavinia W. widow, h. 51 Martin
 Bradstreet Lillias Miss, boards 51 Martin
 Bradstreet Nathaniel F. salesman, h. 16 Troup
 Bradstreet Nehemiah C. h. 44 North St. Paul
 Bradstreet Ransford, h. 110 University av.
 Bradstreet Samuel W. agent, bds. 51 Martin
 Bradt James, boot cutter, 55 Mill, house 199 Brown
 Bradt Joseph, foreman, Exchange opp. Glasgow, b. 93 Plymouth av. [Brown
 Bradt Noah, shoe cutter, 55 Mill, boards 199
 Bradt Willard S. letter carrier, house 40 S. Washington
 Brady Anna P. (*Hartman & Brady*), 18 E. Main, house 6 Greig

Brady Catharine, widow, h. 17 Fitzhugh
 Brady Catharine, nurse, b. East av. c. Prince
 Brady Charles A. (*Cox & Brady*), 83 North
 Water, house 145 Lake av.
 Brady Ellen, widow, h. 38 Mt. Hope av.
 Brady Ellen, widow, house 46 Weld
 Brady Gilbert (*Whitmore, Brady & Co.*),
 Fitzhugh c. Erie canal, h. 22 Adams
 Brady James, teamster, house 187 Brown
 Brady John R. painter, 165 E. Main, bds. 46
 Weld
 Brady Marcellaine, dressmaker, bds. 36 Lake
 avenue [avenue
 Brady Margaret, clerk, boards 38 Mt. Hope
 Brady Michael, policeman, City Hall, house
 44 Monroe av.
 Brady Sarah E. Mrs. house 16 Briggs' block
 Brady William H. shoemaker, 15 Mill, bds.
 44 S. St. Paul [Bolivar
 Braggins Seth, machinist, 123 Mill, house 77
 Brainard George G. carriage painter, 3 Canal,
 h. McLean n. Genesee
 Brairton James, deceased March 6, 1876
 Brairton Michael, butcher, house 68 Averell
 Braithwaite Mary, widow, h. 38 Lake av.
 Braithwaite Mary, seamstress, b. 38 Lake av.
 Braithwaite Robert, house 26 Elm
 Braithwaite Sarah, physician, 26 Elm, h. do.
 Brakman Henry, harnessmaker, 128 East
 Main, h. Thomas near Clifford
 Braman Julia M. widow, boards Meigs near
 Monroe avenue [bds. do.
 Braman Sidney S. crockery, 135 East Main,
 Branch William, removed from city
 Brand William, laborer, North Water near
 Andrews, h. 25 Nassau
 Brandenburger Andrew, removed to Scotts-
 ville [W. Smith
 Brandenburger Anthony, farmer, bds. 79
 Brandenburger Frances, widow, h. 79 Smith
 Brandt Adolphus, salesman, 53 E. Main, h.
 Marshall cor. Green [bds. do.
 Brandt Henry M. foreman, 18 N. St. Paul,
 Brandt Louis W. publisher Rochester Volks-
 blatt, 18 North St. Paul, h. do.
 Brandt Samuel, house Goodman near the
 University [av. b. 12 Cottage
 Branigan Michael, engineer, 205 Plymouth
 Branigan Thomas, cork cutter, 205 Plymouth
 avenue, bds. Cottage n. Plymouth av.
 Branscombe Alice, sewing, b. 13 Anson pk.
 Braraton James Mrs. widow, house 17 Cady
 Brasch Adam F. deceased Nov. 22, 1875
 Brasch Valentine, carpenter, h. 20 Concord
 avenue [n. Clifford
 Brash Charles, machinist, h. Evergreen park
 Brash Valentine, carpenter, h. 157 North av.
 Brashaw James, carpetweaver, boards 298
 Monroe avenue
 Brasser Christian, cartman, h. 250 N. Clinton
 Brasser Gabriel, polisher, h. Thomas near
 Clifford [n. St. Joseph
 Brasser George, laborer, h. Hayward park
 Brasser George, 2d, painter, 5 S. St. Paul, h.
 Huron near St. Joseph
 Brasser Jacob, coachman, house Goodman
 n. East av. [Norton
 Brasser Martin, farmer, h. St. Joseph near

Brassington Henry B. salesman, 64 State, b.
 22 Frank
 Brast Augusta, tailoress, boards 40 Madison
 Brast Christian, carpenter, 118 Mill, house
 40 Madison [40 Madison
 Brast Christopher J. clerk, 73 E. Main, b.
 Brast Rebecca, tailoress, 42 Madison, b. 40 do.
 Brauch Peter, laborer, house 45 Nassau
 Braun Ambrose, tailor, house 47 North av.
 Braun Conrad, deceased March 21, 1876
 Braun Jacob, laborer, h. Hudson n. Clifford
 Braun Jacob, machinist, b. 94 N. Clinton
 Braun John, tinsmith, 121 Lyell, house do.
 Braun Joseph, driver, 44 Front, house 21
 Leopold
 Braun Lorenz, tailor, b. 255 N. Clinton
 Braun Louis, painter, house 16 Hope
 Braun Michael, peddler, h. Barth n. Vienna
 Braun Susan, widow, h. Miller n. Bay
 Brautigam Amelia M. tailoress, b. 5 Comfort
 Brautigam Gustave, cutter, 14 Mumford, h.
 rear 80 Joiner
 Brautigam Henry, tailor, house 5 Comfort
 Brautigam Henry J. butcher, 78 Monroe av.
 bds. 69 Chestnut
 Brautigam Mary L. tailoress, bds. 5 Comfort
 Braxmier Geo. M. laborer, h. 9 Champion
 Bray George W. removed to Canada
 Brayer August, moulder, 8 Hill, b. 159 Jay
 Brayer Elizabeth, clerk, 113 East Main, bds.
 159 Jay [c. E. Maple
 Brayer Frank N. moulder, 8 Hill, bds. King
 Brayer Jacob, carpenter, house 248 Jay
 Brayer Jacob G. watchmaker, 2 State, h.
 246 Jay
 Brayer John, moulder, 8 Hill, h. 166 Jay
 Brayer John C. moulder, 8 Hill, house 112
 Orchard [E. Maple
 Brayer John F. tinsmith, 8 Hill, b. King, c.
 Brayer Michael, house 110 Oak
B RAYER NICHOLAS, president, Co-op-
 erative Iron Foundry, 8 Hill, h. King c.
 E. Maple.—See page 614
 Brayer Nicholas, 2d, moulder, 8 Hill, house
 Railroad alley [Orange, h. 242 Jay
 Brayer Nicholas L. (*Kase & Brayer*), 108
 Brayer Peter, upholsterer, 7 N. Water, bds.
 248 Jay
 Brayer Stephen, saloon, 159 Jay, house do.
 Brayer Stephen, jr. foreman, 8 Hill, house
 96 Saxton
 Brayley Jas. Rochester Agricultural Works,
 100 S. St. Paul, house at Buffalo
 Brayshaw James, carpet weaver, r. 307 State,
 house do.
 Brayton Frances, widow, house 218 W. Main
 Brayton Julia, widow, house 45 Marshall
 Brayton Julius F. (*Stockbridge, Brayton & Co.*),
 75 N. Water cor. Mumford, house 24 S.
 Clinton
 Brayton J. Adelbert, bookkeeper, 75 North
 Water, bds. 24 S. Clinton
 Brayton Louisa, widow, house 68 Exchange
 Brayton Olive, widow, bds. 24 S. Clinton
 Brayton Olive E. Miss, dressmaker, bds. 45
 Marshall
 Brayton William M. deceased May, 1875
 Breadner William, varnisher, h. 8 Bauer

Breakey James R. shoemaker, 124 Front, h. 6 Litchfield
 Breakey James W. Union Hotel, 54 West avenue, house do.
 Breck Ellen Miss, boards 52 East avenue
BRECK GEORGE, agent American Popular Life Insurance Co., 22 Exchange, h. 52 East av.—*See page 509*
 Breck George, city scavenger, 75 Pinnacle avenue, house do.
 Breck Martin B. house 6 East
 Breck Mary Miss, house 52 East avenue
 Bredius Cornelius, carpenter, house 3 Vose near Hudson [bds. 49 N. Frances
 Breckel William, stone cutter, Oak c. Smith,
 Breen Henry, laborer, house 43 W. Maple
 Brees Henry, laborer, h. 95 North avenue
 Breese John H. bill poster, bds. 66 Prospect
 Breese Mary, stitcher, bds. 20 North avenue
 Breese Mary F. Miss, stitcher, b. 66 Prospect
 Breese Sidney A. cook, house 66 Prospect
 Breese William A. telegrapher, Brackett House, boards 66 Prospect [n. Herman
 Breihahn Albert, coach trimmer, h. Thomas
 Breitenbach Michael, moulder, 187 W. Main, house 55 Asylum [h. 33 Buchan pk.
 Breithaupt George, laborer, 255 N. St. Paul,
 Brelmier Geo. pumppmaker, 135 Lyell, h. do.
 Brennan Andrew, painter, b. 76 Broadway
 Brennan Andrew, house 120 Fitzhugh
 Brennan Austin, clerk, boards 120 Fitzhugh
 Brennan Catharine, widow, boards 14 Platt
 Brennan Edward L. carriage trimmer, bds. 120 Fitzhugh
 Brennan Edward J. physician, 1 South, h. do.
 Brennan Eliza, widow, boards 4 Pitt
 Brennan Francis, laborer, Brown cor. Jones, house 62 Cady [120 Fitzhugh
 Brennan Frank X. clerk, 36 State, boards
 Brennan James, trunk maker, foot Rowe, b. 33 Jones [depot, house 4 Howell
 Brennan John, baggageman, N. Y. C. R. R.
 Brennan John, mason, house 78 N. St. Paul
 Brennan John, carpet cleaner, bds. 102 Mill
 Brennan John H. baggageman, N. Y. C. depot, boards 4 Howell
 Brennan Lawrence S. clerk, 8 State, boards 43 S. Washington [near Seward
 Brennan Maggie Miss, tailoress, bds. Cottage
 Brennan Martin H. cigar maker, boards 76 Broadway [76 Pearl
 Brennan Martin P. moulder, 20 Court, house
 Brennan Mary, widow, house r. 7 Granger
 Brennan Mary Miss, packer, 105 Plymouth avenue, boards Cottage near Seward
 Brennan Mary, widow, house 103 Cady
 Brennan Michael, laborer, house Cottage n. Seward [Fitzhugh n. Adams
 Brennan Michael, porter, Ayers' Hotel, h. 119
 Brennan Nellie Miss, tailoress, bds. Cottage near Seward
 Brennan Patrick, tailor, h. 43 S. Washington
 Brennan Patrick, house 4 Howell
 Brennan Robert J. sexton, Immaculate Conception church, bds. 127 Plymouth av.
 Brennan Thomas, servant, Osburn House
 Brennan Thomas F. collector, 53 E. Main, boards 43 S. Washington

Brenner Adam, laborer, house 124 Wilder
 Brenner John, farmer, house N. Clinton, cor. Norton
 Brerton James, bookkeeper, boards 2 Centre
 Brerton Mary A. F. dressmaker, b. 2 Centre
 Brerton Patrick J. bartender, 2 Centre, b. do.
 Breternitz Traugott, butcher, h. 74 Reynolds
 Brett Newton I. carpenter, h. 12 Schleyer's block [E. Main cor. Lancaster
 Brett William C. bartender, 36 W. Main, h.
 Brettell Amelia L. teacher, Central School No. 5, boards 9 Thompson
 Brettell Francis S. & Son (*George E. Brettell*), machinists, Brown's race foot Furnace, house 9 Thompson [h. 39 Frank
 Brettell George E. (*F. S. Brettell & Son*), Breu George, shoemaker, 140 Brown, house 2 Walnut
 Breu Jacob, carpenter, house 99 Cady
 Brewer Albert, Rochester Opera House, bds. Asylum
 Brewer Ella Miss, boards 20 Vick park
 Brewer Erastus A. removed to Syracuse
 Brewer Frank P. clerk, 103 State, boards 45 Sophia
 Brewer Heman S. house 117 N. St. Paul
 Brewer Hulbert J. property man, Opera House, boards 43 Scio
 Brewer Joel C. house 43 Scio
 Brewer Mary G. Miss, bds. 117 N. St. Paul
 Brewer Samuel S. house 2 Mumford
 Brewster Edward, deceased Feb. 1876
 Brewster E. Frank (*Brewster, Gordon & Co.*), bds. 83 Fitzhugh

BREWSTER, GORDON & CO. (J. H. Brewster, D. M. Gordon and E. F. Brewster), wholesale grocers, 80 East Main.—*See page 550* [14 Troup

Brewster Harry P. clerk, 80 E. Main, boards
 Brewster Henry C. cashier Traders' National Bank, 35 W. Main, boards 45 S. Clinton

BREWSTER HENRY & CO. (S. Remington and J. McTaggart), grocers, 72 East Main, h. 39 S. Clinton.—*See page 551*

Brewster Horace C. salesman, 6 S. St. Paul, boards 66 Fitzhugh

BREWSTER H. AUSTIN & CO. (P. V. Crittenden), grocers, 6 S. St. Paul, house 66 Fitzhugh.—*See page 550*

Brewster H. Pomeroy, house 18 Troup
 Brewster James L. house 158 West avenue
 Brewster Joel H. moulder, house Terry near North Frances [house 83 Fitzhugh

Brewster John H. (*Brewster, Gordon & Co.*),
 Brewster Perry J. salesman, 53 East Main, house 79 Mt. Hope avenue

BREWSTER SIMON L., president Traders' National Bank, 35 West Main, h. 45 South Clinton.—*See page 494.*

Brewster William Mrs. house 39 Troup
 Brezinzki Andrew, teamster, 138 Oak, house 25 Wilder

Brezinzki Catharine, widow, b. 8 Widman
 Brezinzki Joseph, bds. 273 Brown
 Brezinzki Peter, laborer, bds. 273 Brown
 Brichler Chas. B. grocer, 194 Exchange, h. do.
 Brichler Joseph, deceased 1876 [11 Swan
 Brichler Joseph, screw cutter, 123 Mill, bds.

Brichler Rosa, widow, h 11 Swan
 Brickell Wm. stonecutter, b. Frances c. Brown
 Bricker Martin, carpenter, h. 214 Monroe av.
 Brickner Henrietta, widow, b. 20 William
 Brickner Max (*G. and J. Wile & Co.*), 64 Mill,
 house 20 William
 Bridgeford Mary L. widow, h. 13 Sycamore
 Bridgeman Augusta Mrs. h. 91 N. Clinton
 Bridgeman David, produce buyer, boards
 6 Ely [avenue
 Bridgeman George, h. Fourth cor. Glenwood
 Bridgeman Harry, removed to Churchville
 Bridgeman Rachel, widow, bds. Fourth cor.
 Glenwood avenue
 Bridle Thomas, baker, house 218 W. Main
 Briemer Aloys, carver, 133 N. Water, bds.
 21 Concord avenue
 Briemer Caspar, shoemaker, house 21 Con-
 cord avenue [house do.
 Briemer Nicholas, shoemaker, 49 Kelly,
 Brien Thomas, cooper, Charles cor. Butler,
 house 98 Cady [bds. 8 North Ford
 Brier Etherbert, stonecutter, 54 Fitzhugh,
 Brierly Samuel B. Rochester Theological
 Seminary, bds. Trevor Hall
 Briggs Alma O. Miss, private school, 24 E.
 Main, h. 11 Gibbs
 Briggs Charles, clerk, 93 State, b. 19 Fitzhugh
 Briggs Charles, butcher, h. 135 Champlain
 Briggs Charles S. clerk, 91 State, boards 25
 Fitzhugh
 Briggs Charles W. (*Briggs & Brother*), house
 25 Fitzhugh
 Briggs Edward, removed to Cleveland, O.
 Briggs Edward S. clerk, bds. 24 N. St. Paul
 Briggs Edward T. clerk, 93 State, boards N.
 St. Paul
 Briggs Everett D. mason, h. 52 Sherman
 Briggs Fidelia, widow, bds. 52 Sherman
 Briggs Gilbert, carpenter, bds. 52 Sherman
 Briggs Hamlet S. (*M. Briggs & Son*), 188
 State, house 32 Jay
 Briggs Hiram D. removed to Grafton, O.
 Briggs James, student University of Roches-
 ter, boards 23 Chestnut
 Briggs James B. laborer, bds. 13 Ely
 Briggs James H. varnisher, h. 20 Sherman
 Briggs John, removed to Chicago, Ill.
 Briggs John T. real estate, h. 34 N. St. Paul
 Briggs Laura Mrs. dressmaker, b. 318 State
 Briggs Lizzie Mrs. boarding, 39 N. St. Paul
 Briggs Marsenus H. lawyer, 76 Powers'
 bldgs. boards 7 George
BRIGGS MARTIN & SON (*H. S. Briggs*),
 safe and iron fence manufs. 188 State,
 h. 181 do.—*See page 681*
 Briggs Mercy M. house 11 Gibbs
 Briggs Sarah S. Mrs. house 19 Fitzhugh
 Briggs Sophia F. Mrs. deceased May 20, 1875
 Briggs William, switchman, b. Leighton av.
 near Culver [house do.
 Briggs William H. physician, 75 E. Main,
 Briggs William H. jr. clerk, 91 State, house
 26 South Union [Chatham
 Briggs William J. clerk, 75 E. Main, bds. 5
BRIGGS & BROTHER (*C. W. Briggs*),
 seed warehouse, 91 and 93 State.—*See*
page 534

Brigham Alvin W. clerk, 36 East Main, bds.
 143 do.
 Brigham George H. removed to Syracuse
 Bringman John, agent, house 7 Orange
 Bringman John B. shoemaker, b. 7 Orange
 Brink Clarke M. student, University of Ro-
 chester, boards 80 Court
 Brink Geo. W. salesman, r. 141 E. Main, b. do.
 Brink Peter, laborer, 20 Court, h. 11 Pryor
 Brink — tailor, bds. 25 Marietta
 Brinker Henry, commission merchant, 22
 Exchange, h. St. Paul c. Hart av.
 Brinkerhoff Alonzo T. painter, boards 44
 North avenue
 Brinkerhoff Cornelius R. patternmaker, h.
 44 North avenue [h. 208 E. Main
 Brinsmaid Henry, agent, 73 South St. Paul
 Brinsmaid Wm. F. cashier, h. 208 E. Main
 Brisco Abram A. salesman, 49 Mill, bds. 153
 East Main
 Brisco M. E. Mrs. boards 143 East Main
 Brister Thomas H. removed to Moravia
 Bristol Arthur H. brakeman, bds 10 Glasgow
 Bristol Homer C. student, Roch. Theological
 Seminary, bds. Trevor Hall
 Bristol Martin F. (*Chase, Bristol & Viele*), 5
 Aqueduct, h. 17 Ambrose
 Bristol Mary G. widow, h. 7 S. Washington
 Bristow Frank, tinsmith, Vacuum Oil Works,
 bds. 41 Greig [av. b. 41 Greig
 Bristow George S. gardener, 81 Plymouth
 Bristow Rhoda, widow, house 41 Greig
 Bristow William, produce, h. 245 Exchange
 Britenstool Henry, bookkeeper, 106 State, b.
 41 North Clinton
 Britenstool Hirsch & Son (*J. A. Britenstool*),
 clothing, 106 State, h. 41 N. Clinton
 Britenstool Jacob A. (*H. Britenstool & Son*),
 house 89 Atwater
 Britenstool Julius, salesman, 106 State, bds.
 41 N. Clinton
 Britton Albert R. removed to Irondequoit
 Britton Alexander P. flour and feed, 153 S.
 St. Paul, house do.
 Britton Alonzo, veterinary surgeon, 5
 Division, house Meigs st. bridge
 Britz John, machinist, 8 Hill, h. 144 Pin-
 nacle avenue [22 Monroe av.
 Brizee Charles C. clerk, 134 E. Main, bds.
 Brizee Henry S. teamster, h. 37 Huntington
 Brizee J. Christopher, h. 22 Monroe avenue
 Brizee Martin W. brakeman, N. Y. C. R. R.
 bds. 37 Huntington
 Broad Charles H. clerk, 8 E. Main, house
 George cor. William
 Brock Annie Miss, boards 1 Linden
 Brock Charles J. house 20 North avenue
 Brock Harry C. salesman, 15 E. Main, bds.
 54 North Union [26 Platt
 Brock James W. clerk, 15 E. Main, house
 Brockenshire William F. photographer, h.
 5 Greenwood avenue
 Brockett Cornelia, widow, house 63 Troup
 Brockett Frederick A. architect, 64 Powers'
 buildings, boards 63 Troup
 Brockett William J. draughtsman, 64 Powers'
 buildings, boards 63 Troup
 Brockmann Louis, house 307 Jay

- Brockway Caroline M. Mrs. artist, house 22 Caledonia avenue [h. 26 Emmett
Brockway Henry I. machinist, 150 N. Water,
Brockway William, clerk, 50 State, boards 36 N. Washington [65 Prospect
Brodie John, paperhanger, 9 West Main, h.
Brodie Lilly T. forewoman, bds. 45 Bolivar
Brodie William, carpenter, house 45 Bolivar
Brody Mary, widow, house R. R. near Union
Brogan James, moulder, 187 W. Main, house 4 East Maple [House
Bromley Charles P. (*Bromley & Co.*), Osburn
Bromley Daniel H. (*Bromley & Co.*), Osburn House
BROMLEY & CO. (*D. H. and C. P. Bromley*), props. Osburn House, East Main corner N. St. Paul.—*See page 567*
Bronislawski Sigismund, watchmaker, Court corner Stone, house 18 Mark
Bronner Caroline, widow, h. 20 N. Clinton
Bronner Charles, student, bds. 20 N. Clinton
Bronner Henry M. clerk, 14 West Main, b. 20 N. Clinton [Clinton
Bronner Israel, salesman, boards 20 North
Bronner Roland, salesman, 64 Mill, boards 20 North Clinton
Bronner S. B. peddler, 144 East Main
BRONSON AMON & SON (*A. Bronson, jr.*), lumber and planing mill, Exchange opp. Troup, h. 77 Plymouth av.—*See page 652*
Bronson Amon, jr. (*A. Bronson & Son*), Exchange opp. Troup, b. 79 Plymouth av.
Bronson Henry (*Day & Bronson*), 133 East Main, house do. [perance building
Bronson Loemma E. widow, house 52 Temple
Bronson Mary, widow, house 66 Allen
Brook Dennis, teamster, house 12 Zimmer
Brooker Mary A. clerk, boards 96 Frank
Brookheart Abram B. saloon, 201 East Main, boards 169 do.
Brooks Arthur, removed to Syracuse
Brooks Benjamin, grocer, 62 Broadway, h. do.
Brooks Calvin, farmer, house at Rapids
Brooks Chester P. agent, 40 West Main, bds. Clinton Hotel
Brooks Edward, carpenter, 188 State, boards Orange corner Grape
Brooks Elizabeth, bds. East av. c. Alexander
Brooks E. Sherman, auction rooms, 110 W. Main, house 40½ Fitzhugh
Brooks James G. boards 11 Phelps avenue
Brooks James S. house 87 South avenue
Brooks John G. removed to Eden, Ohio
Brooks John H. watchman, house rear 144½ Mt. Hope avenue
Brooks John M. ass't editor Evening Express, 23 West Main, boards 21 Asylum
Brooks Joseph D. rem'd to Providence, R. I.
Brooks Lewis, 90 West Main, boards Osburn House [State
Brooks Margaret Mrs. laundress, house 222
Brooks Martha Mrs. house 141 Frank
Brooks Mary, widow, h. Orange cor. Grape
Brooks Mary A. domestic, boards 31 Meigs
Brooks Peter H. conductor, house 2 Mumford
Brooks Thomas, house 67 Jay [h. 39 Frank
Brooks Thomas, harnessmaker, 20 Market,
Brooks William, clerk, 188 State, b. Orange cor. Grape
Brooks William A. (*Brooks & Reynolds*), h. Backus avenue near Phelps avenue
Brooks William D. (*Brooks & Reynolds*), h. Phelps avenue corner Fulton avenue
Brooks & Reynolds (*W. D. and W. A. Brooks and J. A. Reynolds*), shoe manuf. 139 State
Broom Frederick, steward, Osburn House, h. 14 N. St. Paul [Hotel
Brophy John, salesman, 24 State, b. Clinton
Brophy William, laborer, house 1 Green
Brost Charles, carpenter, house 69 Troup
Brost Frankie Miss, seamstress, b. 69 Troup
Broth Catharine, widow, bds. 11 Huntington
Brothers John, carpenter, b. 7 Briggs' place
Brothers Peter R. (*Kingsley & Brothers*), 92 Powers' buildings, house 104 Genesee
Brothers Rachel A. Mrs. nurse, b. 11 Vincent place [b. 104 Genesee
Brothers Thomas H. bookkeeper, 222 E. Main,
Brothers of St. Mary, East Maple n. King
BROTSCH CHARLES G. ornamental plasterer, 9 Andrews, house 39 Martin.—*See page 624* [near Huntington
Brotsch Frederick A. mason, house 253 North
Brotsch Victor, mason, house Henrietta av. near Allmeroth [22 Sophia
Brough William, sign painter, 74 Arcade, h.
Broun Cornelius, varnisher, house 14 Vose
Brousky Harris, cigarette maker, 55 South St. Paul, house 9 Griffith
Brouwer Cornelius T. physician, 12 Elm, house do.
Brower Aaron, 77 Pinnacle avenue, h. do.
Brower Caroline C. widow, h. 23 Alexander
Brower John, clerk, 73 East Main
Brower Thomas J. sup't Street R. R., State corner Centre, house 11 Ambrose
Brown Aaron, boards 142 Hudson
Brown Adam, clerk, 6 Asylum, boards 8 do.
Brown Adam, market, 42 Front, house 215 East Main corner Cherry
Brown Alanson, machinist, *Brown c. Jones, house 246 Brown [86½ Tappan
Brown Alexander, clerk, 222 E. Main, bds.
Brown Alexander G. shoemaker, house 126 Adams [house 46 North Union
Brown Alexander M. foreman, 32 N. Water,
Brown Alexander R. blacksmith, boards 102 Strong
Brown Alice C. Miss, house 35½ Glasgow
Brown Amanda C. Miss, nurse, boards 19 Ambrose
Brown Amelia Miss, boards 169 State
Brown Andrew, finisher, 73 N. Water, house 221 Plymouth avenue
Brown Ann Mrs. boards 83 Fulton avenue
Brown Augusta, widow, house 113 Campbell
Brown Augustus, gardener, house Lewis n. Mt. Vernon avenue
Brown Aurelia E. Miss, boards 29 Court
Brown Aurelia J. boarding house, house 21 William
Brown A. James, cartman, boards 12 Dean
Brown A. Joseph, lockmaker, h. 130 Adams
Brown Bela E. jeweller, 14 State, house 90 Plymouth avenue

- Brown Benjamin, engineer, N. Y. C. R. R. house 128 Jones
- Brown Bridget, widow, house 54 Griffith
- Brown Caroline M. teacher, Rochester Orphan Asylum, boards 35½ Glasgow
- Brown Carrie L. Miss, boards 96 Frank
- Brown Charles, student, University of Rochester, b.37 Court [h. 20 Edinburgh
- Brown Charles J. brakeman, Erie Railway,
- Brown Charles A. student, University of Rochester, bds. 37 Court
- Brown Charles A. shipping clerk, 136 Mill, house 9 Conkey av. [h. 18 Frank
- Brown Charles F. machinist, Brown c. Jones,
- Brown Charles H. clerk, 67 East Main, bds. rear 139 Monroe av.
- Brown Charles W. carpenter, h. 126 Tremont
- Brown Charles W. salesman, 78 State, h. 14 White
- Brown Charlotte H. widow, b. 72 Lake av.
- Brown Diantha Mrs. h. Tremont c. Reynolds
- Brown Donald S. student, University of Rochester, boards 5 Stillson
- Brown Dyer D. S. Rochester Printing Co. 3 West Main, house at Scottsville
- Brown Edward, laborer, bds. 149 South av.
- Brown Edward, removed to Toronto, Ont.
- Brown Edward, shoemaker, h. 33 George
- Brown Edward C. mason, bds. 36 Glasgow
- Brown Edward D. millwright, 127 Mill, h. 8 North Frances [near city line
- Brown Edward S. farmer, h. Thurston road
- Brown Edwin, sawyer, bds. rear 139 Monroe avenue [avenue
- Brown Edwin H. porter, house 18 Caledonia
- Brown Emily A. dressmaker, 91½ E. Main, house do.
- Brown Emily M. widow, bds. 21 Bolivar
- Brown Emma, widow, house 139 S. St. Paul
- Brown Eugene, shoemaker, 73 N. Water, bds. 85 Atkinson
- Brown Everett A. bds. 246 Brown
- Brown E. Della, teacher, Genesee school, No. 4, bds. 246 Brown [119 Lyell
- Brown Francis, blacksmith, 145 East Main, h.
- Brown Francis A. boards 142 Hudson
- Brown Frank D. brakeman, N. Y. C. R. R bds. 100 Mill [b. 16 Olean
- Brown Fred. jr. shoemaker, 91 North Water,
- Brown Frederick, carpenter, h. 16 Olean
- Brown Frederick, carpenter, h. 219 North
- Brown Frederick H. hatter, 20 Elwood blk. bds. 211 St. Joseph
- Brown George, pressman, Vacuum Oil works, bds. 16 Olean [E. Main
- Brown George, clerk, 42 Front, boards 215
- Brown George, clerk, 118 Front, boards 148 Exchange [h. 10 N. Ford
- Brown George, chairbottomer, 46 West av.
- Brown George, house 11 East
- Brown George, market, 6 Asylum, h. 8 do.
- Brown George H. grocer, 116 State, house 7 Union park [Hope avenue
- Brown George H. conductor, house 91 Mt.
- Brown George W. agent, house 1 Genesee
- Brown George W. bookkeeper, bds. 20 St. Joseph [11 East
- Brown George W. cashier, 53 East Main, bds.
- Brown Grove, salesman, 101 State, boards 36 Fitzhugh [b. 65 Hickory
- Brown Hamilton A. clerk, 95 East Main,
- Brown Harrison H. boarding house, 11 Chestnut park
- Brown Harry M. comedian, h. 22 Oregon
- Brown Harvey, painter, bds. 14 Woodbury
- Brown Harvey W. (Smith, Perkins & Co.), 16 Exchange, h. 126 Alexander
- Brown Hattie Miss, bds. 84 North Clinton
- Brown Henry B. gardener, house Hudson c. Weeger [Frank
- Brown Henry M. painter, 14 Stone, h. rear 76
- Brown Henry O. clerk, 124 State, house do.
- Brown Henry S. stone quarry, 142 Hudson, house do.
- Brown Hiram, real estate, 115 Hudson, h. do.
- Brown Ira P. clerk, 5 State, b. 139 Monroe av.
- Brown James, house 15 Adams
- Brown James, road master, house 240 Brown
- Brown James, painter, bds. 200 West Main
- Brown James, salesman, house 3 Warehouse
- Brown James A. carpet layer, 37 State, house 5 Ward [315 do.
- Brown James D. produce, 241 East Main, h.
- Brown James F. bookkeeper, b. 315 E. Main
- Brown James H. boards 142 Hudson
- Brown James M. tailor, 83 Lyell, house do.
- Brown James W. machinist, b. 4 Edinburgh
- Brown Jane, widow, house 62 Mt. Hope av.
- Brown Jane H. widow, house 148 Exchange
- Brown Jane M. widow, house 51 Frank
- Brown Jane N. Miss, teacher, Oakman School No. 20, bds. 107 St. Joseph
- Brown Jeremiah A. moulder, 8 Hill, house 26 Prospect
- Brown John, laborer, bds. 107 Fulton av.
- Brown John, ice peddler, house 8 Emmett
- Brown John, 102 Front, bds. 89 N. Union
- Brown John, laborer, boards 83 Lyell
- Brown John, tanner, 87 N. Water, h. 211 St. Joseph
- Brown John, sawyer, bds. 211 St. Joseph
- Brown John E. student, University of Rochester, boards 80 Court
- Brown John H. whitewasher, h. 36 Glasgow
- Brown John H. coachman, 37 Troup, house 38 South Ford
- Brown John H. jr. porter, Osburn House
- Brown John J. springmaker, h. 20 St. Joseph
- Brown John M. salesman, 74 Mill, h. 28 Kent
- Brown John M. sashmaker, h. 10 East park
- Brown John M. shoemaker, 27 Walbridge's buildings, house 56 Charlotte
- Brown John R. planemaker, h. 76 Weld
- Brown John S. 102½ East Main, house at Spencerport
- Brown John S. carpenter, 23 Park av. h. 21 do.
- Brown John T. switchman, Erie Railway depot, house 175 Exchange
- Brown Joseph (Brown & Robinson), 30 Canal, house 9 White
- Brown Joseph, driver, house 21 Leopold
- Brown Joseph, coachman, h. 20 Monroe av.
- Brown Joseph, machinist, 100 South St. Paul, bds. 35 Stone [h. 130 Adams
- Brown Joseph A. lockmaker, Court c. Stone,
- Brown Julia, widow, h. 14 Woodbury

HENRY C. WISNER,

WHITE CHINA DINING and TEA SETS,
No. 33 STATE STREET.

Brown Julia A. Mrs. nurse, bds. 5 Vienna
 Brown Julius E. tailor, h. 113 Campbell
 Brown J. Fred. bookkeeper, b. 315 E. Main
 Brown Lemuel, laborer, h. 66 West Troup
 Brown Libbie I. teacher, Franklin School,
 No. 6. bds. 51 Frank
 Brown Libbie J. Miss, teacher, Franklin
 School, No. 6, h. 9 Spencer
 Brown Lucy, dressmaker, h. 139 Monroe av.
 Brown Maggie, clerk, bds. 81 Magne
 Brown Maggie A. dressmaker, 20 St. Joseph,
 boards do. [Comfort
 Brown Maggie E. Mrs. vestmaker, boards 12
 Brown Mahlon W. removed to Prescott, Ont.
 Brown Margaret, domestic, b. 10 Upton park
 Brown Martha A. widow, h. 68 S. St. Paul
 Brown Mary Miss, house 9 Spencer
 Brown Mary, widow, b. 15 Moore near R. R.
 Brown Mary, widow, bds. 21 Park avenue
 Brown Mary, widow, bds. 56 Charlotte
 Brown Mary, widow, h. Waverly pl. n. Julia
 Brown Mary A. widow, house 17 James
 Brown Mary A. widow, house 86½ Tappan
 Brown Mary A. Mrs. milliner, 87 N. Clinton,
 house do.
 Brown Mary E. Mrs. boards 39 Reynolds
 Brown Mary O. teacher, Franklin School
 No. 6, boards 51 Frank
 Brown Mary R. widow, boards 100 Fitzhugh
 Brown Mathew M. student, University of
 Rochester, boards 64 Chestnut
 Brown Melvin, fireman, at Water Works, h.
 92½ Scio [65 Hickory
 Brown Melville F. bookkeeper, 80 State, h.
 Brown Michael, moulder, 20 Court, house
 85 Atkinson
 Brown Nancy, widow, boards 127 West av.
 Brown Nettie Mrs. boards 46 North av.
 Brown Oscar E. waiter, b. Tremont corner
 Reynolds
 Brown Oscar F. farmer, h. Bay n. Goodman
 Brown Phebe L. widow, boards 5 Tremont
 Brown Richard, tinsmith, 76 East Main, h.
 89 South Union
 Brown Richard A. actor, Roch. Opera House
 Brown Robert, carpenter, house 25 Park av.
 Brown R. Canning, canvasser, 6 State, bds.
 170½ West Main
 Brown Samuel, detective, City Hall, boards
 Brackett House
 Brown Sarah, widow, boards 53 Adams
 Brown Sarah H. widow, boards 19 Ambrose
 Brown Sardia P. widow, h. 5 Greenwood
 avenue [b. 2 Oregon
 Brown Selden S. student, University of Roch.
 Brown Sophronia, widow, house rear 139
 Monroe avenue [115 Wilder
 Brown Stephen L. moulder, 20 Court, house
 Brown Susan, widow, bds. 42 University av.
 Brown Thomas, manager, 96½ Front, b. do.
 Brown Thomas, stove packer, bds. 83 Lyell
 Brown Thomas, peddler, b. Waverly n. Julia
 Brown Thomas, glue maker, h. 102 Strong
 Brown Thomas, fireman, Vacuum Oil Works
 Brown Thomas H. teamster, bds. 24 Spring
 Brown Thomas J. oil maker, h. 109 Frances
 Brown Thomas M. house 123 South St. Paul
 Brown Thomas T. carpenter, h. 17 Gregory

Brown T. Edwin, pastor, Second Baptist
 Church, house 52 Park avenue
 Brown Warren S. salesman, 92 State, house
 at Attica
 Brown Wm. flour and feed, 109 Lyell, h. do.
 Brown Wm. carpenter, house 115 Hudson
 Brown Wm. laborer, house 5 Summer
 Brown Wm. laborer, boards 83 Lyell
 Brown Wm. removed to Toronto, Ont.
 Brown William, painter, rear 145 East Main,
 house 55 Cypress [Bolivar
 Brown William C. clerk, 70 Mill, house 30
 Brown William E. laborer, h. 42 Sherman
 Brown William G. laborer, bds. 102 Strong
 Brown William G. bookkeeper, 55 South St.
 Paul, boards 11 East
 Brown William H. tinsmith, 133 North av.
 house 194 do. [Tappan
 Brown William H. clerk, 10 Mill, bds. 86½
 Brown William J. painter, boards 1 Ely
 Brown William J. boxmaker, foot Centre, h.
 56 Reynolds
 Brown William J. finisher, Court cor. Stone,
 house 25½ South Ford
 Brown William L. whitewasher, h. Hunter
 cor. Reynolds
 Brown William L. carpenter, h. 21 William
 Brown William M. h. Bismarc n. Genesee
 Brown Wm. N. clerk, National Hotel, b. do.
 Brown William R. bookkeeper, 53 E. Main,
 house 11 East [park
 Brown William S. game constable, h. Joslyn
 Brown Wm. T. produce, h. 42 Manhattan
 Brown Winnifred, widow, h. Pine n. Spring
BROWN & ROBINSON (*J. Brown and C.*
D J. Robinson), tight coopers, 30 Canal.—
See page 678
 Brown, see Braun [25 Tremont
 Brownell Aaron, salesman, 92 State, house
 Brownell Adam, cartman, bds. 8 Hunter
 Brownell Annie D. grocer, 327 State, h. do.
 Brownell Aurelia, widow, bds. 22 Broadway
 Brownell Corydon C. house 34 Hunter
 Brownell Edwin P. bookkeeper, 5 Front, h.
 3 Lawrence [h. 75 S. Union
 Brownell Ephraim, foreman, 117 East Main,
 Brownell Fay E. clerk, 327 State, bds. do.
 Brownell George A. artist, 155 W. Main, b.
 Laburnam near Monroe avenue
 Brownell Gerritt, grocer, 8 Hunter, h. do.
 Brownell Henry W. shoemaker, 7 South St.
 Paul, house 327 N. Clinton
 Brownell J. Augustus, clerk, Waverley House,
 boards do. [Monroe av.
 Brownell Myron S. agent, h. Laburnam n.
 Brownell Polly, widow, bds. 78 Monroe av.
 Brownell William, clerk, 51 East Main, h.
 22 Pearl
 Browney Henry, hack driver, bds. 38 Allen
 Browns Wright H. machinist, Mill cor. Fac-
 tory, house 224 State [Savannah
 Brownyard Catharine A. widow, house 33
 Brownyard Frederick J. shoemaker, 79 N.
 Water, house 80 Lincoln n. Landing
 Brownyard Geo. H. teamster, b. 33 Savannah
 Brownyard George N. driver, Osburn House,
 boards do. [ard
 Broxholm Joseph W. shoemaker, b. 9 Sew-

Broxholm Thomas, carpenter, 93 Exchange, house 9 Seward [Seward
 Broxholm Thomas jr. printer, 6 State, b. 9
 Broyle William, nurseryman, house Culver near Schanck avenue [231 Exchange
 Bruce Alexander, machinist, 89 N. Water, h.
 Bruce Alexander M. plumber, 57 State, house 27 Hickory
 Bruce David, laborer, house 22 Saxton
 Bruce David, teamster, Court st. bridge, h. 125 Fitzhugh
 Bruce David W. leather dresser, 35 North Water, house 96 do. [son c. Julia
 Bruce James B. carriage trimmer, h. Atkin
 Bruce Janet, stitcher, boards 17 Gorham
 Bruce John S. machinist, 89 N. Water, h. 67 Bartlett [n. N. St. Paul
 Bruce Mary, packer, 38 Gorham, b. Clifford
 Bruce Robert, laborer, house 22 Saxton
 Bruce Sarah, widow, boards 22 Saxton
 Bruce Walter, leather dresser, 37 N. Water, house 17 Gorham [Henion pl.
 Bruce Wm. A. hairdresser, 5 Exchange, b. 16
BRUCE WM. H. bathing and laundry, 5 Exchange, h. Henion place n. Clifton.—
See page 567
 Bueck George, grocer, 119 South av. h. do.
 Bruegger Chas. carpenter, h. Childs n. Orange
 Bruegger Gottlieb, carpenter, b. 29 Hollister
 Bruegger Jacob, piano maker, 4 Hill, house 38 North Union
 Bruegger Victor, deceased 1875
 Bruegger Xavier, cabinet maker. h. 19 Tyler
 Bruehl Albert, carpenter, house 10 Hawkins
 Bruff Charles A. bookkeeper, 39 N. Water, bds. 37 Edinburgh
 Bruff Ellen, widow, boards 6 Cypress
 Bruff James L. bookkeeper, b. 37 Edinburgh
 Bruff Robert G. printer, 82 West Main, house 6 Cypress [h. 4 Pleasant
 Bruff William W. bookkeeper, 4 Exchange,
 Bruins William J. blacksmith, h. 59 Baden
 Bruman Albert H. janitor, Rochester Savings Bank, h. 60 Cypress
 Bruman Chauncey, removed to Avon
 Bruman George, teamster, h. 125 Broadway
 Brumby Charles, painter, h. 250 Plymouth av.
 Brun John, laborer, boards 167 Jay
 Brundage Samuel M. shoemaker, 15 Mill, h. 1 Emmett
 Brundage William H. house 1 Grove
 Brundige William H. carpenter, h. 61 Baden
 Brunn Sarah R. widow, bds. 176 W. Main
 Brunner Anton, bootmaker, 2 Mumford, h. 5 Wait
 Brunner Joseph, file grinder, River near N. Water, bds. Platt n. Frank [265 Jay
 Bruno Sister Mary, sister superior, boards
 Brunswick Edward, bookkeeper, b. 2 Joiner
 Brunswick Solomon, butcher, house 2 Joiner
 Brunton Crawford, removed from city
 Brutsche Minrad, laborer, house 2 Kondolf
 Brutscher Michael, moulder, 8 Hill, house Childs near Jay
 Bryan Amelia, widow, house 65 Tremont
 Bryan Elisha W. sup't. Children's Home, 263 N. St. Paul, house do.
 Bryan Eliza, widow, bds. 29 Plymouth av.

Bryan E. W. Mrs. matron, Children's Home, 263 N. St. Paul, house do.
 Bryan Frank A. clerk, 62 State, boards 46 Marshall
 Bryan Frederick F. painter, bds. 102 Mill
 Bryan George S. filter maker, 108 Exchange, house 14 Warehouse [boards do.
 Bryan Horace D. printer, 11 North St. Paul,
 Bryan H. C. Mrs. dining rooms, 11 N. St. Paul, house do.
 Bryan James A. pressman, boards 50 Kent
 Bryan James C. telegrapher, 34 Arcade, bds. 65 Tremont
 Bryan Jane E. Mrs. boards 6 Elm [Kent
 Bryan John L. drugs, 176 W. Main, bds. 50
 Bryan Luther S. house 46 Marshall
 Bryan Oswald J. clerk, 176 West Main, bds. 50 Kent
 Bryan Thomas, cooper, house 98 Cady
 Bryant Cora G. Miss, boards 16 Chatham
 Bryant Edwin R. foreman, house 2 Rowe
 Bryant George, carpenter, 3 Canal, house 125 Tremont
BRYANT JONATHAN P. magnetic physician, 150 Powers' buildings, house do.
See front cover and front colored page
 Bryant Marcia, widow, bds. 49 S. Clinton
 Bryant Silas, clerk, 88 Plymouth av. boards Plymouth avenue House
 Bryce Robert W. tinsmith, 266 State, house 22 Smith
 Brydges Ellen, widow, h. 42 Brown's alley
 Bryson Robert, boiler maker, h. 20 White
 Bubser Jacob J. flour and feed, 100 South avenue, house 139 do.
 Bubyear Dugald, bookkeeper, b. Wilder pl.
 Bubyear Edward, laborer, 90 E. Main, bds. Wilder place
 Bubyear Margaret, widow, h. Wilder place
 Buchan Elizabeth A. widow, bds. 163 North Clinton [106½ W. Main
 Buchan Gertrude Mrs. dressmaker, house
 Buchan Emily, widow, house 29 Elizabeth
 Buchanan John T. laborer, h. 7 Ambrose
 Buchanan Sarah E. milliner, b. 7 Ambrose
 Buchecker Frederick, tinsmith, 75 North Clinton, house do.
 Buchmuller Gottlieb, cabinetmaker, Aqueduct, house 199 Alexander
 Buchmuller John, carrier, Post Office, house 67 Meigs
 Buchner Sarah, widow, bds. 100 St. Joseph
 Buchs Edward, laborer, 66 Hudson, bds. 111 North avenue [house do.
 Buchterkirch August, grocer, 31 Vienna,
 Buchterkirch Henry A. printer, 23 W. Main, boards 13 Saxton
 Buchterkirch Mary, widow, house 13 Saxton
 Buck Amanda M. widow, house 18 John
 Buck Albert H. boards 18 John
 Buck Edward G. baggageman, N. Y. C. R. R. boards 18 John [81 Mague
 Buck Frederick, miller, Frankfort Mills, h.
 Buck George, servant, National Hotel, b. do.
 Buck George, clerk, boards 18 John
 Buck Henry L. clerk, 147 State, boards 66 S. St. Paul [Scottsville
 Buck Henry R. agent, 5 Aqueduct, house at

- Buck Jackson M. conductor, N. Y. C. R. R. boards Brackett House
- Buck Michael L. collarmaker, 98 E. Main, boards 40 Colvin [house 43 Stone
- Buck Wesley C. machinist, Court c. Stone,
- Buckland Frank J. tinsmith, b. 30 Lake av.
- Buckland Henry O. cigar maker, boards 30 Lake avenue [logical Seminary
- Buckland R. J. W. prof. Rochester Theo-
- Buckland Warren L. b. 171 Monroe avenue
- Buckler William H. foreman, 3 Aqueduct, boards 129 Mt. Hope av.
- Buckley Benj. student, boards 28 Pearl
- Buckley Charles, house 13 Hand
- Buckley Charles jr. physician, 62 E. Main, boards 13 Hand [Paul
- Buckley Charles A. tinsmith, h. 168 N. St.
- Buckley Conrad, machinist, h. 20 Sellinger
- Buckley Daniel, laborer, h. 51 Genesee
- Buckley Frank J. tinsmith, 29 Exchange, h. 86 Adams
- Buckley George N. salesman, bds. 28 Pearl
- Buckley Helen, widow, bds. 3 Monroe av.
- Buckley Jas. salesman, 33 State, b. 13 Hand
- Buckley James, contractor, h. 3 Gardiner pk.
- Buckley James F. clerk, 34 W. Main, bds. 9 Cameron [Shamrock
- Buckley James W. clerk, 88 Mill, house 10
- Buckley Jane, widow, house 63 Adams
- Buckley Johanna, widow, house 138 Plymouth avenue [138 Plymouth av.
- Buckley Johanna A. Miss, stitcher, boards
- Buckley John, laborer, h. 98 N. St. Paul
- Buckley John, switchman, Brown st. crossing, boards 31 Frank [n. Rowe
- Buckley John, machinist, 106 Mill, h. Third
- Buckley Mary, tailoress, boards 31 Frank
- Buckley Mary, widow, boards 28 Gorham
- Buckley Michael J. coachmaker, 3 Canal, boards 14 do. [do.
- Buckley Regina A. oysters, 7 S. St. Paul, h.
- BUCKLEY RICHARD B.** hatter, 62 East D Main, boards 13 Hand.—See page 542
- Buckley Roger A. furnaceman, h. 89 Meigs
- Buckley Thomas, peddler, house 9 Cameron
- Buckley Thomas R. express messenger, bds. 26 Emmett
- Buckley William, laborer, house 31 Frank
- Buckner Frederick W. removed to Leipsic, Germany
- Budd Alden T. removed to Greece
- Budd Daniel, house 117 Frank
- Budd Evan W. clerk, 280 State, boards 117 Frank [Upton park
- Budd Frank D. clerk, 14 Exchange, b. 20
- Budd Hiram, carpenter, 87 Exchange, house 10 Cypress
- Budd Isabella, seamstress, boards 6 Platt
- Budd Stephen, house 20 Upton park
- Budlong Samuel J. lawyer, b. 120 North av.
- Budlong Sarah A. widow, h. 120 North av.
- Bueckel Jacob, hostler, boards 102 Front
- Bueg John, grinder, 68 Front, house do.
- Buehule John, cabinet maker, 133 N. Water, house 5 Baden
- Bueler Emil, house 200 North
- Buell Addie, music teacher, b. 159 East av.
- Buell Albert G. house 31½ Chestnut
- Buell Eben H. clerk, 37 State, b. 31½ Chestnut [Washington
- Buell Eben N. (Buell & Levet), h. 8 South
- Buell Frances E. Miss, house 28 Court
- DUELL GEORGE C. & CO. (J. W. Canfield and J. B. Bloss),** wholesale grocers, 36 Exchange, house 6 Livingston park.—See page 551
- Buell Geo. E. chiropodist, 75 Arcade, b. 45 Scio
- Buell Jesse W. student, 21 S. Clinton, b. do.
- Buell John F. painter, house 13 Thomas
- Buell J. Milton, boards 33½ Chestnut
- Buell Mary W. widow, boards 21 Hudson
- Buell Mortimer, salesman, b. 314 East Main
- Buell Walter, student, Fitzhugh cor. West Main, boards 314 East Main [n. Bates
- Buell William E. shoemaker, house Sibley
- Buell & Levet (E. N. Buell and W. B. Levet), insurance, 22 Exchange
- Buelte Amelia, boards 47 Atwater
- Buelte Frederick, carpenter, 14 St. Joseph, boards 47 Atwater
- Buelte Joseph, tailor, house 11 St. Joseph
- Buelte Magdalene, widow, house 47 Atwater
- Buenzow John, carpenter, house Bay near Goodman [Wildner
- Buff August, wood worker, b. Childs corner
- Buff Enos, moulder, 8 Hill, house 46 Wildner
- Buff Geo. moulder, 8 Hill, b. Niagara House
- Buff George 2d, moulder, 8 Hill, b. 46 Wildner
- Buff Louis, boarding house, 36½ S. St. Paul
- Buff Michael, house 60 Campbell
- Buff Michael, shoemaker, h. Childs c. Wildner
- Buff Michael jr. engineer, 55 Mill, h. Childs near Wildner
- Buff Nettie, stitcher, bds. 36½ S. St. Paul
- Buff William, laborer, 8 Hill, b. 46 Wildner
- BUFFALO STEAM GAUGE AND LANTERN CO.,** 31 State.—See front colored page.
- Buges Charles F. A. cabinet maker, house 173 Scio
- Buges Fred, laborer, boards 173 Scio
- Bugg Alfred, gardener, house 35 Kent
- Buhl Barbara, widow, h. Hague n. W. Maple
- Buhl Dorothy, widow, b. Hague near West Maple
- Buhl Lorenz, laborer, house 42 Campbell
- Buhl Michael, laborer, 20 Court, h. Magnolia near Genesee
- Bühler Joseph (Kolb, Rosenberg & Co.), Mumford c. Mill, b. 71 North Clinton
- Buhler Samuel, blacksmith, Platt cor. Kent, house 47 Lime [house do.
- Buhlmann Henry W. grocer, 105 North av.
- Buhr Frederick, saloon, 92 N. Clinton, h. do.
- Buker Amos M. salesman, h. 17 N. Frances
- Bulger Andrew T. shoemaker, b. 1 Edinburgh [Mt. Hope av.
- Bulger Catharine- M. widow, house rear
- Bulger Dennis, boatman, b. 54 West av.
- Bulger James H. scale maker, boards 23 Mt. Hope av. [Stephens's park
- Bulger John, flagman, Allen st. crossing, h. 1
- Bulger John C. clerk, 129 Mill, boards 1 Stephens's park [Stephens's park
- Bulger Maggie F. gilder, 38 Gorham, b. 1

Bulger Mary A. gilder, 38 Gorham, boards 1
 Stephen's park
 Bulger Mary A. Miss, house 13 Kent
 Bulger Nancy, widow, house 1 Edinburgh
 Bulger Patrick, shoemaker, boards r. 23 Mt.
 Hope av. [Rochester
 Bulkley Benjamin R. student, University of
 Bulkley George N. agent, 61 State
 Bulkley Mason, salesman, 36 Exchange, bds.
 29 South Union
 Bulkley Sarah E. widow, boards 21 Elm
 Bull Charles H. ass't surveyor, 57 Arcade, b.
 15 Greig
 Bull Clifton B. stenographer, b. 15 Greig
 Bull Geo. coachman, 59 Plymouth av. b. do.
 Bull Henry, salesman, 184 State, house 15
 Greig
 Bull Johnson, h. Woodford pl. n. Harris av.
 Bull Samuel, farmer, house Lake av. corner
 McCracken
 Bullard Fisher Mrs. deceased Oct. 1875
 Bullard John H. (*J. S. Irwin & Co.*), 107
 Mill, house 9 Clifton [do.
 Bullinger Balthasor, saloon, 8 Elizabeth, h.
 Bullinger Balthasor, jr. grocer, 6 Elizabeth,
 boards do. [St. Paul
 Bullinger Henry, shoemaker, b. 35 North
 Bullingham Joseph, deceased 1876
 Bullis Charles Mrs. widow, b. 11 Selden
 Bullis Louis H. foreman, 178 Plymouth av.
 boards 37 Glasgow
 Bullis Martin, agent, boards 60 Fitzhugh
 Bullman Martha, widow, b. 94 North av.
 Bulloch Alexander, salesman, 73 East Main,
 boards 119½ East Main
 Bullock Lucy, dressmaker, boards 15 Joiner
 Bump Amos S. removed to Greece
 Bump Duane A. collector, 15 North St.
 Paul, boards 60 Atkinson
 Bump Frank S. laborer, 36 Exchange, bds.
 Lake avenue near Ridge road
 Bump William H. clerk, boards 12 Cliff
 Bunce Geo. C. laborer, boards 253 State
 Bunde August, saloon, 26 Front, house do.
 Bundschuh Fred. carpenter, h. 132 Scio
 Bundschuh Peter, carpenter, h. Lincoln near
 Channing
 Bundy Jennie E. nurse, 58 Monroe av. b. do.
 Bunker Ann Miss, boards 16 Jay
 Bunker Catharine, shoe presser, bds. 16 Jay
 Bunker Margaret, widow, h. 29 Fulton av.
 Bunker Mary Miss, house 16 Jay
 Bunker Robert, cooper, 73 Frank, h. 14 Jay
 Bunn William H. canal supt, at weighlock,
 house at Brockport [near Magnolia
 Bunnel Reuben A. salesman, h. Mansion
 Burbank Abner, house 72 East avenue
 Burbank Mary, widow, b. Troup cor. Favor
 Burbank Solomon M. farmer, h. 93 Alexan-
 der [Meigs
 Burbott August, laborer, h. Caroline near
 Burbott Charles, laborer, house 12 Widman
 Burbott Charlotte, widow, b. 12 Widman
 Burbott Henry F. laborer, house 16 Widman
 Burbott Herman, mason, h. 168 N. Clinton
 Burch Frank G. bookkeeper, 65 West Main,
 house 56 Hickory
 Burch Henry, deceased March 7, 1876

Burch Peter R. bleacher, 38 Mumford, bds.
 11 Centre pk. [Jones, h. 4 Montrose
 Burch William, machinist, Brown corner
 Burchard Seth E. shoe cutter, 111 State, h.
 149 East Main
 Burchell Samuel, laborer, bds. 92 Munger
 Burchell Thomas A. detective, City Hall,
 bds. 143 North av. [vent, b. Jay c. Frank
 Burchmans Sister, teacher, Nazareth Con-
 Burcke Peter, blacksmith, Brown c. Jones,
 house 66 Orange
 Burckhardt Andrew, tailor, h. 292 St. Joseph
 Burckhardt August, optician, h. 3 Edward
 Burgard August, spinner, bds. 100 Orange
 Burgard George, spinner, bds. 100 Orange
 Burgard John, spinner, house 252 Brown
 Burgard Martin, overseer, Rochester Cotton
 Mill foot Centre, house 100 Orange
 Burgard Sophia Mrs. confectionery, 252
 Brown, house do. [22 University av.
 Burgelin John, market, 51 North av. house
 Burgen William, printer, bds. 9 S. Ford
 Burger Anton, laborer, h. 37 Scrantom
 Burger Christopher, butcher, h. 56 Franklin
 Burger George, machinist, N. Water cor.
 Andrews, house 31 Mt. Hope avenue
 Burger John, house 13 Mathews
 Burger John jr. (*Burger & Lang*), house 2
 Comfort
 Burger & Lang (*J. Burger jr. and G. Lang*),
 potters, 4 Mt. Hope avenue
 Burgess Catharine, widow, house 19 Spring
 Burgess Closson P. wood pavement, 76 South
 Ford, house do.
 Burgess E. Byron, bookkeeper, Bank of
 Rochester, 41 State, boards 26 Court
 Burgess George, removed to Troy
 Burgess John, tobacconist, 23 West Main,
 house 144 Saxton [bds. 76 S. Ford
 Burgess John A. student, 118 Powers' bldgs,
 Burgess William, foreman, house 89 E. Main
 Burgess William, ale, 4 Exchange place, h.
 26 Court [37 William
 Burgess William, clerk, 4 W. Main, house
 Burgess William S. bookkeeper, 4 Exchange
 place, h. East Main cor. Lancaster
 Burger Christian, clerk, 140 E. Main, boards
 56 Franklin
 Burger, see Berger
 Burget Mary J. boards 246 State
 Burgeys Lewis, blacksmith, 35 S. St. Paul,
 house 18 Erie
 Burghardt Edward H. foreman, Middle Falls
 near St. Paul, bds. 2 Frank
 Burgie Daniel, carpenter, house 47 Baden
 Burgley Felix, painter, boards Ames near
 West Maple [5 Franklin sq.
 Burglin Ernst, butcher, 100 N. St. Paul, b.
 Burgmaster Daniel, laborer, h. 138 Ply-
 mouth av. [house 54 do.
 Burhause John, varnisher, 141 N. Water,
 Burkard John, lockmaker, Court cor. Stone,
 bds. 26 Delevan
 Burkard John B. grocer, 26 Delevan, h. do.
 Burkard John M. grocer, 103 South av. h. do.
 Burkard Margaret, hair worker, boards 26
 Delevan [bds. do.
 Burkart Joseph, baker, 45 North Clinton,

Burke Alex. laborer, h. 20 Vincent place
 Burke Bernard, clerk, house 9 East pk.
 Burke Catharine, house 61 Sibley's block
 Burke Catharine D. grocer, 112 East av. h. do.
 Burke Charles J. (*Burke, Fitz Simons, Hone & Co.*), 53 East Main, bds. Osburn House
 Burke Dennis, laborer, house 59 Adams
 Burke Dennis, laborer, house 20 West
 Burke Dennis J. cooper, house Thompson
 Burke Edward A. dentist, 100 State, house 32 Smith
 Burke Elizabeth J. boards 25 Thompson
 Burke Ellen C. widow, house 28 Oak
 Burke Ernst F. clerk, 104 East av. bds. do.
BURKE, FITZ SIMONS, HONE & Co.
 (*C. J. Burke, Charles Fitz Simons, A. B. Hone, and P. Mahon*), dry goods, 53 E. Main.—*See page 545* [h. 15 Mortimer
 Burke George S. coachman, 28 N. Clinton,
 Burke James, cigarmaker, 45 E. Main, bds. rear 272 State
 Burke Jas. E. moulder, 20 Court, h. 24 do.
 Burke John, laborer, gas works, house 81 Magne near Saxton [cor. Genesee
 Burke John, student, St. Mary's Hospital
 Burke John, laborer, house 142 Jones
 Burke John, laborer, bds. 44 North Water
 Burke John F. gardener, h. 43 S. Ford
 Burke John H. carpenter, b. 20 Vincent pl.
 Burke John J. mason, house 62 Kirk
 Burke John P. laborer, h. 44 North Water
 Burke Joseph, teamster, 47 S. St. Paul, bds. 24 Hamilton place
 Burke Lena A. dressmaker, 5 Denning, h. do.
 Burke Libbie Miss, house 1 Spencer
 Burke Mary Miss, dressmaker, b. 1 Spencer
 Burke Michael, feeder, 159 State, h. Oak near Lyell
 Burke Michael, teamster, boards 20 West
 Burke Michael, moulder, h. r. 272 State
 Burke Michael, laborer, Citizens' Gas Co. h. Kelsey flats near N. St. Paul
 Burke Michael L. chairmaker, Hastings near River, boards 20 Vincent place
 Burke Nellie M. boards 1 Spencer
 Burke Nicholas, carpenter, h. 8 N. Union
 Burke Nicholas jr. shoe cutter, 91 N. Water, h. 3 Adams
 Burke Patrick, laborer, b. 216 Pinnacle av.
 Burke Patrick & Co. (*J. O'Donaghue and H. D. Williams*), iron founders, 206 State, h. 34 Lake av.
 Burke Peter, moulder, removed to Medina
 Burke Peter, laborer, Exchange n. Troup, h. 3½ Edinburgh
 Burke Peter Y. cutter, 17 Front, h. 29 Hill
 Burke Sarah A. Mrs. dressmaker, house rear 272 State [h. 3½ Edinburgh
 Burke Stephen, shoemaker, 77 N. Water,
 Burke Thomas, sawmaker, h. 11 Jackson
 Burke Thomas, laborer, h. Pine n. Spring
 Burke Wm. laborer, State c. Centre, h. 42 Prospect
 Burke Wm. laborer, h. 216 Pinnacle avenue
 Burke Wm. porter, 26 N. Water, b. 102 N. St. Paul
 Burke Wm. B. (*Wm. Burke & Co.*), bds. 34 Spring corner Washington

Burke William J. chairmaker, Lower Falls, boards 20 Vincent place
BURKE WILLIAM & CO. (*N. A. Stone and Wm. B. Burke*), hardware, iron and steel, 12 West Main, house 34 Spring c. Washington.—*See page 631*
 Burke, see Bourke
 Burker Jacob, laborer, h. Rowe n. Ninth
 Burket James, shoemaker, 39 Brown, h. 22 Lake avenue
 Burkhard August, optician, 179 N. St. Paul, h. Herman n. Henry
 Burkhardt John A. lockmaker, 188 State, h. 112 St. Joseph
 Burkhardt Julius, brass moulder, boards 112 St. Joseph
 Burkhardt Andrew, shoemaker, b. 113 Wilder
 Burkhardt August J. carriagemaker, 3 Canal, bds. 113 Wilder
 Burkhardt George, varnisher, 7 N. Water, b. 113 Wilder
 Burkhardt Martin, teamster, h. 70 N. Clinton
 Burkhardt Simon, laborer, house 113 Wilder
 Burkhardt, see Burkard
 Burleigh Albert D. clerk, 16 Exchange, h. 55 Troup
 Burleigh George H. painter, b. 21 St. Clair
 Burleigh George W. house 21 St. Clair
 Burleigh Jennie E. teacher, Atwater School No. 10 boards 13 Pleasant
 Burleigh Oscar G. clerk, 4 Arcade, bds. 13 Alexander
 Burleigh Theodore F. blacksmith, 3 Canal, b. 21 St. Clair
 Burley Catharine, widow, house 16 Lyell
 Burley Catharine, widow, house 54 Prospect
 Burley George S. (*Burley & Dewey*), house 23 Evergreen
 Burley Hiram C. oil dealer, house 59 Troup
 Burley Maria, waiter, Whitcomb House, b. do.
 Burley Michael, coupler, h. Anderson av. n. University av.
 Burley Miner G. boards 54 Prospect
BURLEY & DEWEY (*G. S. Burley and I. D. H. Dewey*), furniture, 88 State.—*See page 629*
 Burling Alice, housekeeper, b. 55 S. Union
 Burlingame James K. jailor, Monroe Co. jail, house do.
 Burlingame Margaret E. millinery, 83 East Main, house do. [Thomas
 Burmeister William, laborer, h. Weeger n.
 Burnam Caleb, salesman, 100 State, boards Clinton Hotel [Rapids
 Burne Adelbert, teamster, h. Rapids road at
 Burne Ellen, boards 26 Centre
 Burne Percy, laborer, b. Rapids n. Genesee
 Burnett Clara A. confectionery, &c., 189 E. Main, house do.
 Burnett Elizabeth, widow, house 78 William
 Burnett John, tinsmith, 65 Exchange, h. 50 Edinburgh
 Burnett Phebe, widow, house 25 Chatham
 Burnett Schuyler V. D. glazier, 82 E. Main, house 25 Chatham [Lincoln
 Burnham Charles, pattern maker, house 6
 Burnham John, house 54 N. Water
 Burnham Lorenzo, physician, 107 Hudson

Burnham Marcus O. salesman, 73 East Main, bds. 66 South St. Paul [Glasgow
Burns Alexander, agent, 43 E. Main, boards
Burns Alycia, gilder, bds. 15 Ward
Burns Andrew, polisher, 126 State, bds. 200 West Main
Burns Ann, dressmaker, 2 Smith, house do.
Burns Bridget, widow, house 33 Catharine
Burns Catharine, widow, house 15 Ward
Burns Charles, stonecutter, 54 Fitzhugh, b. 188 Champlain
Burns Charles, laborer, house 53 Myrtle
Burns Charles C. bookkeeper, Powers' banking house, boards 28 Spring
Burns Charles J. builder, house Conkey av. cor. Woodford pl.
Burns Daniel, boilermaker, b. 13 Philander
Burns Daniel, clerk, bds. 207 Exchange
Burns Delia Mrs. h. Brown's al. n. Lyell
Burns Edward J. shoemaker, 83 N. Water, b. 44 Smith [N. St. Paul
Burns Edwin C. clerk, 36 State, house 24
Burns Frank, fireman, N. Y. C. R. R. b. 13 Jones
Burns Hannah, deceased Sept. 24, 1875
Burns Helen, widow, boards 330 State
Burns James, laborer, house 68 W. Maple
Burns James W. laborer, house 25 Caroline
Burns Jennie M. bds. 160 State
Burns John, house 82 West av.
Burns John, removed to E. Saginaw, Mich.
Burns John, carriagemaker, 3 Canal, bds. 4 Walnut n. Jay
Burns John, deceased July, 1875
Burns John, laborer, 28 Hill, h. Lincoln cor. Clifford [n. Henrietta av.
Burns John, foreman, house Pinnacle av.
Burns John, removed from city
Burns John, flagman, house 39 Weld
Burns John C. removed to Syracuse
Burns Lizzie, widow, house 13 Philander
Burns Lizzie, boards 5½ Grape
Burns Maggie L. milliner, bds. 2 Smith
Burns Mary, widow, house 32 Clifford
Burns Mary, widow, house 4 Walnut n. Jay
Burns Mary, widow, house 236 State
Burns Michael, teamster, house 256 State
Burns Michael, engineer, h. 190 North
Burns Michael, chairmaker, foot Rowe, bds. 120 Lake av.
Burns Michael J. laborer, house 14 Myrtle
Burns Nicholas, carpenter, h. 5 East Maple
Burns Orville, laborer, h. 63 West avenue
Burns Patrick, Burns' Hotel, 102 Mill, h. do.
Burns Patrick, laborer, house 11 Charles
Burns Patrick, laborer, Court st. bridge, h. 57 Adams
Burns Peter, special deputy county clerk, Court House, house 6 Hand
Burns Peter, painter, 9 W. Main, h. Lyell
Burns Ralph, bartender, 102 Mill, bds. do.
Burns Robert, policeman, City Hall, house 5½ Grape [37 Childs
Burns Robert, shoemaker, 73 N. Water, h.
Burns Samuel, foreman, Hill cor. N. Ford, house 178 Scio
Burns Sarah, widow, h. Childs alley n. Erie canal

Burns Sarah C. widow, house 44 W. Smith
Burns Simon, teamster, paper mill, house 120 Lake av.
Burns Wm. butcher, h. Rapids road near river
Burns Wm. shoemaker, h. r. 162½ North av.
Burr Alfred, laborer, bds. 13 Saratoga avenue
Burr Phebe Mrs. boards 5 Griffith
Burr Susan, widow, house 89 Frances
Burrell Charles F. removed to Denver, Col.
Burrell James, saloon, 274 State, house do.
Burrell John, shoecutter, 55 Mill, house 2 Montrose
Burrell Lizzie A. boards 274 State
Burrough Augustus C. clerk, City Hall, h. 29 Kent
Burrough John, laborer, house 34 Romeyn
Burrough Mary Ann, widow, h. 17 Marshall
Burroughs Alfred P. painter, 7 Ely, boards 20 King
Burroughs Asa, optician, h. 44 University av.
Burroughs Charles, boards 17 Marshall
Burroughs George M. painter, 7 Ely, bds. 20 King
Burroughs Mary, widow, bds. 33 Madison
Burroughs Peter C. painter, 7 Ely, h. 20 King
Burrows Emma J. dressmaker, 26 Scio, h. do.
Burrows Frank L. conductor, N. Y. C. R. R. boards Congress Hall
Burrows Geo. H. division superintendent, N. Y. C. & H. R. R. 151 State, h. 39 Sophia
Burrows Jennie A. dressmaker, 127 State, boards do. [Hope av.
Burrows Margaret, dressmaker, h. 45 Mt.
Burrows Martin, house 67 Charlotte
Burrows Mary, widow, boards 77 Court
Burrows Wellington, cigarmaker, bds. 87 Averill
Burt Alfred W. butcher, house 34 Strong
Burt Lilian, hairdresser, house 111 E. Main
Burtis Amanda E. widow, boards 89 William
Burtis Sarah A. widow, bds. 52½ N. St. Paul
Burtis Squire, bookkeeper, h. 89 William
Burton Frederick, clerk, 4 Exchange place, boards 26 Court
Burton James, clerk, boards 143 N. Clinton
Burton Joseph, shoemaker, 4 Allen, h. 143 N. Clinton
Burton Matthias, shoemaker, 83 N. Water, boards 143 North Clinton
Burton Orseumus D. overseer, Penitentiary, house 30 Oakland park
Burton Reuben, student, boards 3 Meigs
Busby Joseph C. thermometer maker, 3 Hill boards 2 Hubbell park
Busby William, thermometer maker, 3 Hill, house 2 Hubbell park
Busby William J. printer, 82 W. Main, h. 41 Mt. Hope av. [bell, h. do.
Busch Barbara Mrs. baker, Grape c. Camp-Busch Charles, porter, house 66 Strong
Buschler Edward, laborer, h. 27 Monroe av.
Bush Benjamin F. groom, Centre n. Mill, b. Ford
Bush Charles, agent, house 14 S. Ford
BUSH DANIEL W. insurance agent, 8 Exchange place, h. 101 Fitzhugh.—See page 503
Bush Elizabeth, widow, house 15 James

- Bush Ellen, widow, house 13 Ward
 Bush George N. cooper, house 30 West av.
 Bush Gregory, butcher, h. 19 Cayuga place
 Bush Horace F. stove maker, Oak n. Jay, h. 38 Spring [55 Joiner
 Bush Jacob H. trunk maker, 78 State, house
 Bush John F. stove maker, Oak n. Brown, bds. 23 Elizabeth
 Bush Julia S. teacher, Monroe school No. 15, boards 68 South Union [Union
 Bush J. James, reporter, 6 State, bds. 68 S.
 Bush Peter P. pressman, 1 Aqueduct, bds. 55 Joiner
 Bush Robert W. insurance agent, house 68 S. Union [house 210 North-
 Bush Samuel T. engineer, N. Y. C. R. R.
 Bush William C. (*C. J. Hayden & Co.*), 184 and 186 State
 Bushey Alexander (*Roche & Bushey*), 34 Mumford, h. 82 Magne
 Bushey Louis, laborer, h. 129 S. St. Paul
 Bushman William, laborer, h. Cayuga place
 Bushnell Herbert L. bookkeeper, 100 State, bds. 4 Reynolds
 Bushnell Orsemus, removed to Brooklyn
 Bushnell William, engineer, house 4 Gibbs
 Bussey Albert E. deceased September, 1875
 Bussey George H. liquors, 65 E. Main, house Stone cor. E. Main
 Busted Jane, widow, house 31 Gibbs
 Busted Thomas, painter, boards 31 Gibbs
 Butcher Charles, salesman, 8 Allen, house at Batavia
 Butler Albert, carver, 117 N. Water
 Butler Alice, stitcher, boards 2 Kent al.
 Butler Benjamin F. street supt. City Hall, h. 24 Greig [2 Kent al.
 Butler Benjamin, carver, 155 N. Water, bds.
 Butler Bridget, widow, house 63 Chatham
 Butler Charles W. clerk, 61 E. Main, bds. Waverley House
 Butler Edward, laborer, house Child's alley
 Butler Edward J. driver, 10 Spring, bds. 16 Elizabeth [N. Washington
 Butler Francis J. agent, 43 State, boards 4
 Butler George D. telegrapher, 34 Arcade, h. 54 Hamilton place
 Butler James, mason, house 97 Kelly
 Butler James, clerk, boards 63 Chatham
 Butler James, laborer, boards Childs' alley n. Erie canal
 Butler James, teamster, boards 16 Vincent pl.
 Butler James, hackman, house 7 Spencer
 Butler James, tailor, house 36 Atkinson
 Butler John, laborer, house 85 Meigs
 Butler John, clerk, 73 N. Water, boards 63 Chatham
 Butler John, laborer, h. r. 34 S. Washington
 Butler John, laborer, house rear 34 Griffith
 Butler John H. painter, boards 85 Meigs
 Butler John W. machinist, Court cor. Stone, boards rear 34 Griffith
 Butler Joseph, saloon, 115 Mill, boards do.
 Butler Julia, rubber maker, bds. 2 Kent al.
 Butler Kittie A. teacher, Monroe School No. 15, boards 85 Meigs
 Butler Louisa, rubber maker, b. 2 Kent alley
 Butler Malvina, widow, bds. 154 Exchange
 Butler Marcus H. (*Butler & Calkins*), house 13 Emerson
 Butler Melancthon S. house 1 Lyell
 Butler M. Louisa, widow, house 2 Kent alley
 Butler Rudolph, carpenter, h. Seager near Lewis
 Butler Samuel P. removed from city
 Butler Sylvanus F. carpenter, h. 55 Spring
 Butler Thomas, cook, house 95 Tremont
 Butler Thomas, clerk, boards 27 Frank
 Butler Wells A. grocer, 57 Spring, h. 55 do.
 Butler William F. telegrapher, 34 Arcade, boards 54 Hamilton place
BUTLER WILLIAM G. coal and lime dealer, Olean n. Plymouth ave. house 8 Frost av. near Olean.—*See page 661*
 Butler William M. plumber, boards 85 Meigs
 Butler William W. watchmaker, Court cor. Stone, boards 3 South
 Butler & Calkins (*M. H. Butler and B. F. Calkins*), planing mill, 13 Warehouse
 Butterfield David, physician, h. 97 Broadway
 Butterfield Hadley J. clerk, American Express Co. 83 State, house 9 Oak
 Butterfield Jerome E. freight agent, Erie Railway, boards Clinton Hotel
 Butterfield Mary Miss, bookkeeper, 149 State, boards 41 Frank [North av.
 Button Alexander, gardener, h. Jennings n.
 Button Alphonzo, agent, house Champlain
 Button Elsesta Miss, boarding house, 306 State
 Button Nelson L. book agent, h. 27 Tremont
 Button Sarah E. widow, house 1 Pine
 Button Thomas, boards 216 Exchange
 Button Thomas jr. hairdresser, 13 Exchange, house 216 do.
 Button William, teamster, b. 80 S. St. Paul
 Butts George, cooper, house 11 Bay
 Butts Isaac, Mrs. widow, house East avenue n. Goodman [b. East av. n. Goodman
 Butts Isaac W. 9 Gould building, 14 State,
 Butts James, laborer, boards 92 Davis
 Butts J. DeWitt, 9 Gould's block, 14 State, boards East avenue n. Goodman
 Butts Luke, coachman, house 25 Meigs
 Byam Eber C. house 43 Asylum
 Byam Frank E. brakeman, b. 40 Tappan
 Byam John G. baggagemaster, N. Y. C. R. R. house 40 Tappan
 Byam William W. boards 43 Asylum
 Byer Conrad, shoemaker, 11 Elwood block, house 32 N. Frances
 Byer John, carpenter, b. rear 4 Delevan
 Byer John M. shoemaker, house 5 N. York
 Byer Michael, shoemaker, N. Water corner Andrews, boards 48 Orange
 Byers Matthew T. carpenter, b. 77 Magne
 Byington Electa F. widow, house 60 Sophia
 Byington George M. boards 60 Sophia
 Byrne Bernard, shoemaker, 91 N. Water, h. 19 Martin [b. 30 Brown's alley
 Byrne Dennis, cooper, Butler corner Charles,
 Byrne Edward, carver, River near North St. Paul, boards 9 Gibbs [Sibley's block
 Byrne John, carpenter, 107 S. St. Paul, h. 88
 Byrne John M. laborer, house 19 Anne
 Byrne Margaret, bds. St. Joseph c. Norton

Byrne Michael, grocer, 182 W. Main, h. do.
 Byrne Nicholas, carpenter, house 25 Bolivar
 Byrne Patrick, laborer, house 9 Gibbs
 Byrne Terence jr. carpenter, h. 13 Orchard
 Byrne Thomas, carpenter, h. Whitney n. R. R.
 Byrne Thomas, house St. Joseph c. Norton
 Byrnes John H. & P. shoe manufacturers,
 91 N. Water, boards 89½ Frank
 Byrnes Michael, teamster, h. Second n. Rowe
 Byrnes Patrick (*J. H. & P. Byrnes*), 91 N.
 Water, house 141 Plymouth avenue

CABIC JOHN, laborer, house Olean opposite
 Frost avenue

Cables James H. agent, house 4 Eagle
 Caddell Mary, widow, bds. 76 Atkinson
 Caddell Richard, shoemaker, 81 N. Water,
 house 56 Tremont
 Cady James B. teamster, Elizabeth c. Hill,
 house 96 Pearl [35 Monroe av.
 Cady William W. clerk at weighlock, house
 Caffery Thomas C. baggageman, house 26½
 Clifton

Cagney Edward, teamster, b. 20 Romeyn
 Cahill Catharine, widow, house 50 Joiner
 Cahill Daniel, laborer, boards 50 Joiner
 Cahill Dennis, laborer, boards 26 South
 Cahill James, switch tender, house 50 Joiner
 Cahill Patrick, laborer, h. 57 Pinnacle av.
 Cain Bartholomew, grocer, 341 State, house
 Saratoga avenue c. Costar
 Cain Michael, clerk, 341 State, b. Saratoga
 avenue c. Costar
 Cain, see Kane

Cairnes James, teamster, boards Cottage near
 Plymouth avenue [mouth avenue
 Cairnes William, laborer. h. Cottage n. Ply-
 Calder Alexander, miller, Crescent Mills, h.
 Myrtle n. Lyell

Calder John, hatter, 20 Elwood block, bds.
 68 University avenue

Calder Robert, tinsmith, h. 68 University av.
 Caldwell Edward S. house 3 Tracy park
 Caldwell G. C. bookkeeper, bds. 23 Brown
 Caldwell John, mason, boards 54 Allen
 Caldwell John S. baker, house 60 Troup
 Caldwell Mary L. widow, h. 101½ Chestnut
 park [Tracy park

Caldwell Samuel P. clerk, 73 E. Main, b. 3
 Caldwell Stephen D. house 140 Alexander
 Caldwell Thos. E. beer manufacturer, 143½
 South avenue, house do.

Caley Charles E. fireman, house 52 Grape
 Caley Hugh, mason, house 46 Orange
 Caley James, switchman, N. Clinton st. rail-
 way crossing, house 11 Joiner

Caley James W. laborer, 250 N. St. Paul
 Caley John, mason, house rear 7 Granger
 Caley William H. mason, b. rear 7 Granger
 Calhoun Archibald C. salesman, 40 State,
 boards 183 do. [bds. 13 Emmett

Calhoun Christina Mrs. hair work, 82 State,
 Calhoun Josephine Mrs. h. 16½ Greenwood av.
 Calihan Dennis, laborer, 20 Court, bds. 148½
 North St. Paul [Brown's al.

Calihan Henry, tailor, 128 State, house 30
 Calihan John, tobacco cutter, house 148½
 North St. Paul

Calihan John, building mover, house 17
 Thompson

Calihan Patrick H. saloon, b. 17 Thompson
 Calihan Thomas, laborer, h. Myrtle n. Otis
 Calihan Thomas F. shoemaker, 83 N. Water,
 boards 17 Thompson

Calihan Timothy, carriage manuf. Chat-
 ham cor. Franklin, h. 5 Atwater

Calkins Albert J. shoemaker, 4 Allen, h. 154
 Wilder

Calkins Alice Miss, boards 21 Meigs
 Calkins Benjamin F. (*Butler & Calkins*), 13
 Warehouse, house Jones n. Smith

Calkins Charles, planer, 13 Warehouse, bds.
 Jones near Smith

Calkins Darius, house 23 South avenue
 Calkins Elisha M. student, University of Ro-
 chester, boards at Brighton [119½ do.

Calkins Moses T. salesman, 13 East Main, b.
 Callaghan Eugene, blacksmith, 1 Allen, b.
 100 East avenue [h. 60 Mt. Hope av.

Callaghan Michael, stonecutter, 54 Fitzhugh,
 Callaghan Michael laborer, house Monroe av.
 near toll gate

Callahan Catharine, widow, h. 247 State
 Callahan Charles, stave cutter, boards 30
 Brown's alley [h. 125 Adams

Callahan Daniel, sawyer, Exchange n. Troup,
 Callahan Daniel, carriage smoother, boards
 Seward corner Frost avenue

Callahan Dennis, laborer, house 7 Ontario
 Callahan Dennis, laborer, h. Finney n. Davis

CALLAHAN JAMES, city bill poster, 8
 Corinthian Hall building, h. 51 Troup.—
 See page 521

Callahan James, engineer, 87 North Water,
 house 14 Ward

Callahan James, carriage smoother, boards
 Seward cor. Frost av.

Callahan Jeremiah, switchman, Brown street
 crossing, house 32 Campbell

Callahan John, carriage smoother, b. Seward
 corner Frost avenue

Callahan Luke, hostler, boards 111 Jones
 Callahan Maggie, boards 18 Allen

Callahan Mary, widow, house 111 Jones
 Callahan Mary, dressmaker, 163 State, bds.
 111 Jones [Gardiner pk.

Callahan Patrick, watchman, 17 State, h. 21
 Callahan Thomas, laborer, h. 178 Champlain

Callahan Timothy, moulder, house Seward
 corner Frost avenue

Callahan, see O'Callahan
 Callan Peter, house 18 Allen [h. do.

Callan Sarah Mrs. boarding house, 18 Allen,
 Callery Bernard, waiter, boards 7 Stone

Callery John B. waiter, Brackett House, h.
 30 Lancaster

Callery Maria Miss, nurse, boards 7 Stone
 Callery Michael, mason, house 7 Stone

Callery Michael J. cigar maker, 45 E. Main,
 house 3 Widman [bds. 7 Stone

Callery Patrick, cigarmaker, 22 S. St. Paul,
 Callery Thomas, marble polisher, h. 7 Stone

Callighan Thomas, mason, h. 3 Miller's alley
 Callihan Peter, teamster, b. 16 Vincent pl.

Callisse Richard, plaster paris work, house
 11 Hill

Callister John, foreman, 124 Front, h. N. St. Paul n. Clifford
 Callister Thomas, carpenter, house 47 Smith
 Callister William, cutter, boards 47 Smith
 Calnan John, mason, boards 62 Exchange
 Calvert John B. student, University of Rochester, boards 82 East avenue
 Calvert Mary A. widow, house 5 Franklin sq.
 Calvert Thomas, collector, h. 24 Palmer's bl.
 Calvet Alfred, mechanic, 179 N. St. Paul, h. 60 Lowell
 Calwell Henry H. clerk, h. Seward n. Strong
 Cambeis Jacob. cabinet maker, 149 N. Water, boards Orange cor. Childs [Childs
 Cambeis Ludwig, shoemaker, h. Orange cor.
 Camburn Adelia, widow, h. 58 Bartlett
 Camburn Catharine, widow, house 15 Marion
 Camburn James W. blacksmith, 3 Canal, b. 58 Bartlett
 Cameron Catharine Miss, bds. 48 Alexander
 Cameron Charles McD. physician, 50 Lake avenue, house do. [Bartlett
 Cameron Emma Miss, 205 Plymouth av. b. 58
 Cameron John C. (*Cameron & Chace*), house at Spuytenduyvil, N. Y.
 Cameron Simon, cooper, house 39 Charlotte
CAMERON & CHACE, (J. C. Cameron and E. B. Chace), lumber dealers, 19 Warehouse.—*See page 653*
 Camier James J. carpenter, boards 8 Kirk
 Camier John, laborer, house 8 Kirk
 Camillus Mother Superior, Sisters of Mercy, 5 South
 Camp Daniel, h. Leighton av. n. Crouch
 Camp Dwight, teamster, house Thompson av. rear of Leighton av.
 Camp Helen Mrs. removed to Alton
 Camp James, carpenter, Court st. bridge, h. 204 Alexander
 Campbell Alexander, house 93 Plymouth av.
 Campbell Alfred, gardener, boards 9 Crouch
 Campbell Ann, widow, house 45 Kirk
 Campbell Anna, domestic, Osburn House
 Campbell Charles, removed to Denver, Col.
 Campbell Charles A. (*Campbell & Van Andern*), house 4 Huntington
 Campbell Charles S. house 4 Arnold park
 Campbell Charles W. machinist, Mill corner Factory, boards 241 State
 Campbell David C. engineer, N. Y. C. R. R. house 61 North av. [tory, b. 241 State
 Campbell David E. machinist, Mill c. Fac.
 Campbell Duncan D. clerk, 4 West Main, h. 45 Gibbs
 Campbell Eliza Miss, house 12 Lyell
 Campbell Emma Mrs. house 1 Favor
 Campbell Frank A. removed to Canandaigua
 Campbell George G. real estate, 50 Chestnut, house do. [boards 241 do.
 Campbell George H. cigarmaker, 341 State.
 Campbell George W. bartender, 88 Plymouth avenue, boards do.
 Campbell Jacob, carpenter, b. 98 W. Smith
 Campbell James, varnisher, bds. 66 Baden
 Campbell James, miller, Irving Mills, Mill near Brown, house 15 Lake av.
 Campbell James, blacksmith, h. 29 Tyler
 Campbell James, saloon, 240 State, h. 241 do.

CAMPBELL JAMES, stoves, furnaces and steam engines, 83 Exchange, house 12 Franklin square.—*See page 626*
 Campbell James R. bookkeeper, Monroe Co. Sav. bank, 31 State
 Campbell Jane, deceased Sept. 1875
 Campbell Jane, widow, house 2 Magne
 Campell John A. physician, 10 S. Clinton, house do. [n. Lyell, b. 15 Lake av.
 Campbell John H. barrel manufacturer, West
 Campbell Joseph B. house 4 Arnold park
 Campbell Joseph B., U. S. weather observer, 212 Powers' bldgs. bds. 16 N. Clinton
 Campbell J. Clark, deceased Sept. 1875
 Campbell Leander M. carpenter, house 4 Huntington
 Campbell Mary J. Miss, boards 15 Lake av.
 Campbell Nancy, widow, house 111 Frank
 Campbell Peter, brakeman, boards 45 Kirk
 Campbell Rachel, widow, bds. 48 Hickory
 Campbell Robert, shoemaker, 51 East Main, boards 107 $\frac{1}{2}$ do.
 Campbell Robert, laborer, h. Sibley n. Culver
 Campbell Robert, polisher, 123 Mill, boards 75 Bolivar
 Campbell Samuel, stove jointer, h. 40 Smith
 Campbell Samuel, engineer, N. Y. C. R. R. house 4 Syracuse
 Campbell Samuel M. pastor Central Presbyterian Church, house 4 N. Washington
 Campbell Sarah Mrs. house 75 West avenue
 Campbell Sarah A. stitcher, bds. 111 Frank
 Campbell Thomas, removed to Syracuse
 Campbell Thomas C. clerk, Irving Mills, bds. 15 Lake av. [h. 118 E. Main
 Campbell William jr. stable, r. 147 E. Main,
 Campbell Wm. D. conductor, bds. 45 Kirk
 Campbell Wm. H. removed to Philadelphia
 Campbell & VanAnden (*C. A. Campbell and C. H. VanAnden*), carpenters, 4 Huntington [opp. Mt. Hope, h. 48 Hickory
 Campin James, marble works, Mt. Hope av.
 Campion Susan E. widow, h. 133 University avenue [Culver n. Webster road
 Candee Henry O. real estate, 56 Arcade, h.
 Cane Anna, domestic, 33 $\frac{1}{2}$ Spencer
 Canfield George W. agent, h. 10 North av.
 Canfield John W. (*G. C. Buell & Co.*), 36 Exchange, house 124 Alexander
 Canfield Mary Mrs. house 16 Smith
 Canfield Sarah, boards 74 East avenue
 Canfield Wm. G. shoecutter, 15 Mill, house 12 Pinnacle avenue
 Cannaby Gertrude, widow, h. 18 Edinburgh
 Cannaby Nancy J. dressmaker, 18 Edinburgh, boards do. [h. 18 Edinburgh
 Cannaby William, stoves, 106 Plymouth av.
 Cannan John J. trunkmaker, ft. Rowe, house Rowe opposite Second
 Cannan Thomas, carpenter, h. 15 Sheridan pk.
 Cannell Robert, carpenter, Brown cor. Jones, house 35 Orange
 Cannon Edward S. driver, b. 47 Saratoga av.
 Cannon Emma H. dressmaker, b. 47 Saratoga avenue [h. 47 Saratoga av.
 Cannon George, engineer, House of Refuge,
 Cannon Lucy, domestic, 85 Lake avenue
 Cannon Wm. turner, bds. 47 Saratoga av.

- Canny Catharine, widow, house 40 Hand
 Canny Ellen, dressmaker, boards 40 Hand
 Canny Isabella, clerk, boards 40 Hand
 Cansdale Colin J. spokemaker, 3 Elizabeth,
 h. 66 Pinnacle av. [b. 66 Pinnacle av.
 Cansdale William D. shoemaker, 87 E. Main,
 Cantley Sarah A. widow, house 23 Vine
 Cantlon James, laborer, b. Court near river
 Canty Daniel, removed to Boston, Mass.
 Canty Mary, gilder, boards 39 Gorham
 Canty Sarah, widow, house 39 Gorham
 Capell Charles A. printer, 3 West Main, house
 8 Maple place [Irondequoit
 Capling Albert A. agent, 69 State, house at
 Cappon Abram J. dry goods, 98 North av.
 boards 1 Oregon
 Cappon John, blacksmith, house 1 Oregon
 Capron Francis M. machinist, Court c. Stone,
 h. 28 Savannah [h. 28 Savannah
 Capron Milton R. toolmaker, Court c. Stone,
 Caraboin Ann, widow, house 3 Edinburgh
 Caraboin Edwin C. laborer, b. 3 Edinburgh
 Carberry Barney, laborer, house 2 Denning
 Carberry John E. clerk, 63 Mill, boards 81
 North Union
 Carberry Joseph, house 81 North Union
 Carberry William, clerk, bds. 81 N. Union
 Card Harriet E. Mrs. dressmaker, 144 Ply-
 mouth avenue, house do.
 Card John P. house 26 South avenue
 Carew Robert G. removed to New York
 Carey Arthur F. plumber, 96 East Main, h.
 4 Pearl
 Carey George W. boards 32 Stone
 Carey Jeremiah H. car driver, h. 49 Davis
 Carey John, house 115½ East Main
 Carey Matilda, widow, house 77 Davis
 Carey Patrick, laborer, gas works, h. 70 Smith
 Carey Patrick, shoemaker, 15 Mill, boards
 York House
 Carey, see Cary
 Carhart Samuel N. clerk, 10 Exchange, h. 42
 Adams [house 4 Atwater
 Caring Frank W. grocer, 101 North Clinton,
 Caring George (*Caring, Weicher & Co.*), 87
 North Water, house 18 Chatham
 Caring Martin, clerk, 87 North Water, boards
 212 North Clinton
CARING, WEICHER & CO. (*George Caring,
 Jacob J. Weicher and Meyer Greentree*),
 leather and findings and morocco manufs.
 87 North Water.—See page 665
 Caring William, leather, h. 212 North Clinton
 Carl Ann, widow, house 56 Pearl
 Carl William, teamster, boards 56 Pearl
 Carl ———, clerk, 14 West Main, b. 180 State
 Carle Andrew, clerk, 73 E. Main, b. 115 State
 Carle George, packer, 14 Exchange, boards
 58 South St. Paul
 Carle Peter, umbrella manuf. 115 State, h. do.
 Carle, see Karle
 Carlin Ann, widow, boards 66 Bolivar
 Carlin John H. clerk, 14 Mumford, b. 18 Stone
 Carlin Mary, widow, house 18 Stone
 Carlisle C. B. ass't editor, 82 West Main, bds.
 National Hotel
 Carman Truman, house 54 Hollister
 Carman Warren, bartender, 86 Mill, h. do.
 Carmichael Dugal, shoecutter, 55 Mill, bds.
 57 Mt. Hope avenue
 Carmichael Enos T. bookkeeper, 23 Front,
 h. 35 Jones av. [Hope av.
 Carmichael George M. carpenter, h. 79 Mt.
 Carmichael Hiram, shoemaker, house 57
 Mt. Hope av. [Hope av.
 Carmichael Mary E. dressmaker, b. 57 Mt.
 Carmody Jeremiah, laborer, house 71 Davis
 Carmody Michael, laborer, house 162 Scio
 Carnall Henry S. baker, 28 Lake av. h. do.
 Carnall Samuel H. photographer, 18 West
 Main, boards 28 Lake avenue
 Carnall William F. removed to Syracuse
 Carnes Ferdinand M. shoemaker, 7 South St.
 Paul, h. 111 Broadway [Howell
 Carnes Hannah, widow, house Broadway n.
 Carnes Henry R. painter, 5 Andrews, house
 14 Foehner
 Carnes John, painter, boards 14 Foehner
 Carnes John A. shoemaker, 7 South St. Paul,
 boards 111 Broadway [S. Frances
 Carnes Patrick, finisher, 43 North Water, h.
 Carnes, see Kearns
 Carney William, laborer, h. 52 Brown's blk.
 Carnihan Mary B. tailoress, b. 51 University
 av. [c. Waverley place
 Carpenter Burr B. machinist, boards Julia
 Carpenter Calvin Mrs. widow, b. 82 Univer-
 sity av. [Waverley place
 Carpenter Caroline, widow, h. Julia corner
 Carpenter Clifton C. insurance agent, 102 E.
 Main, boards 52 Scio
 Carpenter Elias, house 23 Scio
 Carpenter Frank I. agent, 17 West Main, b.
 170½ West Main [iversity av.
 Carpenter George D. agent, house 82 Uni-
 Carpenter George W. bookkeeper, 186 State,
 house Troup corner Favor
 Carpenter Isaac, physician, 22 Favor, h. do.
 Carpenter John L. wool manufacturer, bds.
 32 South Union [Moulson
 Carpenter Mary L. widow, h. Jay corner
 Carpenter Milo, carpenter, h. 5 Thompson
 Carpenter Paul D. removed to Pittsford
 Carpenter Smith, farmer, house 28 Park av.
 Carpenter William P. laborer, Erie Railway
 freight house, boards 29 Julia
 Carpenter William R. lawyer, 37 Arcade, h.
 25 Chestnut [b. 174 do.
 Carr Alexander, rope maker, 167 West av.
 Carr Allen B. physician, 32 N. Clinton, b. do.
 Carr Ebbin Watson, watchman, at paper
 mill, house 3 Brisbane
 Carr Ella L. Miss, teacher, Franklin School,
 No. 6, boards 3 Brisbane
 Carr Jeremiah C. (*Davis, Moulton & Co.*), 36
 Exchange, house at Portsmouth, N. H.
 Carr Joseph N. teamster, h. Oak near R. R.
 Carr Lottie Mrs. dressmaker, h. 69 Monroe
 avenue
 Carr Lydia, widow, house 8 King
 Carr Patrick, removed from city
 Carr William N. agent, house 48 Asylum
 Carr William W. house 21 Sophia
 Carr Wilmot S. shoemaker, 91 North Water,
 boards 92 Sibley's block
 Carrier James B. removed from city

- Carrier Nathaniel W. veterinary surgeon, 62 East Main, bds. 3 William [near Janes
- Carrier Patrick, laborer, house rear Jay
- Carrier William H. veterinary surgeon, 62 East Main, house 3 William
- Carrigan Anna, laundress, Osburn House
- Carrigan James, laborer, h. 61 Tremont
- Carrigan Mary, domestic, Osburn House
- Carrington Henry, farmer, h. 17 Ambrose
- Carrington Wm. H. news agt. b. 17 Ambrose
- Carroll Alonzo, fruit dealer, house 14 Wilson
- Carroll Ann, widow, h. 38 Hamilton place
- Carroll Catharine, widow, house 78 Bartlett
- Carroll Catharine, widow, boards 5 Ely
- Carroll Charles E. clerk, 84 Exchange
- Carroll David, boatman, b. 38 Hamilton pl.
- Carroll Dennis, laborer, house 21 Cole
- Carroll Dennis jr. frame maker, b. 21 Cole
- Carroll Edward, car inspector, h. University avenue opposite Upton park
- Carroll Francis, confectioner, h. 218 W. Main
- Carroll George G. physician, 140 W. Main, house 8 Sophia [b. 36 South Ford
- Carroll James, collar maker, 98 East Main,
- Carroll James, agent, boards 218 West Main
- Carroll James, waiter, Clinton Hotel, b. do.
- Carroll John, laborer, boards 68 Platt
- Carroll John, car inspector, house 26 Foehner
- Carroll John, cooper, 52 Orchard, house 14 Sherman [33 Orange
- Carrroll John C. clerk, 37 State, house
- Carroll John E. machinist, boards 54 Allen
- Carroll John F. shoemaker, 83 North Water, boards 79 Bolivar
- Carroll John H. jr. mason, bds. 10 Savannah
- Carrroll John H. veterinary surgeon, 10 Savannah, house do. [17 Champlain
- Carroll Joseph H. cutter, 87 North Water, b.
- Carroll Joseph P. laborer, b. 10 Savannah
- Carroll Lewis J. clerk, 23 North Water, bds. 58 East avenue
- Carroll Margaret, widow, house 68 Platt
- Carroll Mary, clerk, boards 79 Bolivar
- Carroll Mary, stitcher, boards 49 Atwater
- Carroll Mary Miss, house 15 Martin
- Carroll Mary, dressmaker, boards 21 Cole
- Carroll Mary A. domestic, 1 Whitney place
- Carroll Mary A. stitcher, b. 38 Hamilton pl.
- Carroll Maurice W. finisher, 73 State, boards 79 Bolivar
- Carroll Melvina V. Mrs. boards 50 Atwater
- Carroll Michael H. salesman, 14 West Main, boards 180 State [sing, h. 79 Bolivar
- Carroll Patrick, switchman, Brown st. cross-
- Carroll Patrick, laborer, house 17 Champlain
- Carroll Patrick J. marble polisher, house 9 Hunter
- Carroll Peter, boatman, b. 38 Hamilton place
- Carroll Robert, removed to Greece
- Carroll Thomas, boatman, b. 38 Hamilton pl.
- Carrroll Thomas, roofer, h. 16 South Ford
- Carroll Thomas C. clerk, N. Y. C. R. R. Brown corner Jones, b. 42 Kent
- Carroll Thomas P. removed to Buffalo
- Carroll William, mason, h. 112 N. St. Paul
- Carroll William, laborer, boards 68 Platt
- Carroll William, laborer, boards 30 Kirk
- Carroll William, laborer, h. 29 Spencer
- Carroll William G. telegrapher, 11 Arcade boards 181 Exchange
- Carroll William H. clerk, b. 14 Wilson
- Carroll William J. laborer, b. 29 Spencer
- Carroll W. Thomas polisher, 136 Mill. bds. 21 Cole
- Carruthers James W. foreman, Platt corner Kent, house 21 Bolivar
- Caraskadon Isaac B. laborer, h. 90 Front
- Carson Alonzo, foreman, Leighton bridge and iron works, b. 319 East Main
- Carson Jane, widow, boards 117 Tremont
- Carson John B. manager, 14 Exchange, h. 194 West av. [Hunter
- Carson John L. C. tailor, 21 E. Main, h. 58
- Carson Joseph, laborer, b. Centre c. Mill
- Carson Julia, domestic, b. 111 Alexander
- Carson Kate, chambermaid, Osburn House
- Carson Lizzie, boards 1 Lawrence
- Carson Lottie Miss, stitcher, bds. 117 Tremont
- Carson Maggie, boards 33 North avenue
- Carson Mary A. widow, house 3 Greig
- Carson Rebecca Mrs. widow, b. 194 West avenue [h. 82 Atkinson
- Carson Samuel H. shoemaker, 91 N. Water,
- Carson Thomas A. removed to Hall's Corners
- Carson William, clerk, 30 West av. b. 3 Greig
- Carter Agnes M. seamstress, b. 33 Savannah
- Carter Andrew, basketmaker, h. 32 Rhine
- Carter Ann, boards East av. c. Alexander
- Carter Catharine, widow, house 40 S. Ford
- Carter Charles, cartman, house 16 Rhine
- Carter Charles, laborer, Erie railway freight house, boards 111 Fitzhugh [Paul
- Carter Charles D. V. printer, b. 36½ S. St.
- Carter Elizabeth, widow, house 14 Rhine
- Carter Ella L. school, 26 Sophia, boards do.
- Carter Ezra W. carpenter, 34 North av. h. do.
- Carter George, laborer, house 33 Savannah
- Carter George T. clerk, Osburn House, b. do.
- Carter Giles, agricultural works, 10 South Water, house 21 Andrews [ory
- Carter Huldah, widow, b. Ashland n. Greg-
- Carter Ilus F. carpets, 76 State, h. 26 Sophia
- Carter James, brakesman, N. Y. C. R. R., house 44 Temperance buildings
- Carter Joseph, bricklayer, boards 9 Stone
- Carter Nathan S. tacker, 10 S. Water, boards 21 Andrews [8 Concord av.
- Carter Samuel C. clerk, 14 Exchange, house
- Carter Samuel R. sup't Evening Express, 23 West Main, house 112 Fitzhugh
- Carter William, removed to Scottsville
- Cartright Matthew, removed to Buffalo
- Cartright Robert, engineer, h. 14 Arnold pk.
- Cartter Charles F. boards 14 Chestnut park
- Cartter David K. collector of customs, 31 State, boards 8½ Chestnut
- Cartter Lydia A. W. widow, house 14 Chestnut park
- Cartter M. Frances, boards 14 Chestnut park
- Carty John, yardman, Osburn House, b. do.
- Carty Mary, domestic, Osburn House
- Carvarry Frances, widow, h. Park av. near Sibley [near Sibley
- Carvarry Michael, gardener, bds. Park av.
- Carver Aaron, house 81 Caledonia avenue
- Carver Frank, salesman, b. 53 Hamilton pl.

Carver Philetus S. salesman, h. 53 Hamilton place
 Carver S. Otis, salesman, bds. 53 Hamilton
 Cary Charles. physician, City Hospital, b. do.
 Cary Charles A. salesman, 21 W. Main, bds.
 169 E. Main [bldgs. h. at Brockport
 Cary C. S. P. Mrs. music teacher, 191 Powers'
 Cary Elizabeth, widow, house 52 Howell
 Cary Henry W. (*S. B. Roby & Co.*), 80 State,
 house at Brockport
 Cary, see Carey
 Case Alfred, removed to Avoca
 Case Brothers (*M. H. and H. B. Case*), peri-
 odicals, 13 Monroe av.
 Case Clarence W. shoe burnisher, 81 North
 Water, boards 16 Hamilton place
CASE C. W. carpenter and contractor, 35
 Goodman near Monroe avenue, h. do.—
See page 641 [29 Hudson
 Case Edward A. photographer, 78 State, bds.
 Case Ellen A. widow, house 16 Hamilton pl.
 Case Enos T. student, boards 37 Glasgow
 Case Helen B. Mrs. teacher, Free Academy,
 house 1 Greenwood av. [84 N. Clinton
 Case Henry M. engineer, N. Y. C. R. R. h.
 Case Hiram A. produce, house 29 Hudson
 Case Hiram T. agent, house 61 Lancaster
 Case Hobart B. (*Case Bros.*), b. 13 Monroe av.
 Case Myron H. (*Case Bros.*), b. 13 Monroe av.
 Case Peter, farmer, h. Jennings n. North av.
 Case Truman, farmer, h. Waring road near
 Webster road
 Casey Ann, dressmaker, boards 7 Grape
 Casey Hannah, widow, house 51 Tremont
 Casey James D. foreman, house 38 Front
 Casey James F. bookkeeper, 138 Oak, house
 134 do. [Kent n. Smith
 Casey James H. salesman, 80 State, boards
 Casey James W. physician, 15 Sophia, h. do.
 Casey James W. teamster, house 248 State
 Casey Jane, widow, house 25 Thompson
 Casey John A. teamster, 19 Warehouse, bds.
 Kent near Smith [near Otis
 Casey John C. carpenter, boards Cameron
 Casey John H. clerk, Platt c. Kent, h. 19 Kent
 Casey John J. switchman, Railroad c. Pitt,
 boards 3 Harrison
CASEY J. H. MRS. lace repairer, 19 Kent,
 house do.—*See page 547*
 Casey Katie, dressmaker, boards 7 Grape
 Casey Louisa, domestic, boards 12 Lawrence
 Casey Margaret, dressmaker, bds. 6 Romeyn
 Casey Michael, laborer, boards 25 Thompson
 Casey Owen, laborer, house 289 Jay
 Casey Roger, laborer, h. Cameron n. Otis
 Casey Thomas, shoemaker, h. Kent n. Smith
 Casey Timothy, cartman, 16 Exchange, h. 7
 Grape
 Casey William, switchman, house 6 Romeyn
 Casey Winnifred, widow, house 3 Harrison
 Cashman James, shoemaker, 83 N. Water,
 house 110 Kent alley
 Cashman Patrick, laborer, h. 87 Campbell
 Casler Nellie, widow, house 102½ E. Main
 Cassebeer Adolph, plumber, 174 W. Main,
 boards 171½ E. Main
 Cassel Moses, peddler, b. 114 Pinnacle av.
 Cassidy Francis, laborer, house 55 Lyell

Cassidy James, clerk, 16 Exchange, house
 Caledonia av. cor. Glasgow
 Cassidy Kate Miss, boards 80 Ontario
 Cassidy Lawrence, laborer, h. King c. Brown
 Cassidy Margaret, widow, h. 118 Plymouth
 avenue [Plymouth avenue
 Cassidy Sanford M. shoecutter, boards 118
 Cassidy Sarah L. Miss, photographer, 81 E.
 Main, house 79 do.
 Cassiman John N. machinist, b. 34 Asylum
 Casson Mary, packer, boards 3½ Ward
 Castle Charles D. wines, 68 East Main, house
 43 Marshall
 Castle Francis A. tobacco agent, h. 25 Cole
 Castle George P. clerk, house 56 State
 Castle John W. painter, house 20 W. Troup
 Castleman Frank, wool, 14 N. Water, boards
 Clinton Hotel
 Castleman George, clerk, boards 89 Hudson
 Castleman Henry V. boards 89 Hudson
 Castleman Jacob, house 89 Hudson
 Castleman William S. (*S. S. Eddy & Co.*), 25
 North Water, house 71 Court
 Castner Charles A. cabinetmaker, 2 Hill, h.
 307 North St. Paul
 Caton John, real estate agent, h. 59 Prospect
 Caton Mary J. perfumer, bds. 59 Prospect
 Catt Hattie, domestic, boards 4 Meigs
 Caudle Edward, carpenter, house 272 State
 Caudle Rose Mrs. dressmaker, h. 272 State
 Caudle William T. fireman, house rear 35
 St. Joseph
 Cauffman Joseph (*Rosenthal, Cauffman, &*
Co.), 72 Mill, h. 4 St. Joseph [Andrews
 Cauffman Marcus (*Cauffman & Strouss*), h. 49
 Cauffman & Strouss (*M. Cauffman and E.*
Strouss), clothing, 46 Mill
 Caufield Patrick, policeman, City Hall, bds.
 Magnolia near Frances
 Caufield Patrick, laborer, house 20 Syke
 Caufield Thomas, bds. Magnolia n. Frances
 Cauley Charles & Co. fancy goods, 66 State,
 boards 11 Frank
 Cauley John, machinist, boards 11 Frank
 Cauley Margaret, widow, house 11 Frank
 Cauley Maria L. dressmaker, 11 Frank, b. do.
 Cauley Patrick, clerk, 53 E. Main, boards 11
 Frank [58 S. Union
 Caulkins Marcellus, cutter, 75 N. Water, b.
 Caulkins Russell, 32 E. Main, bds. 12 Arnold
 park
CAULKINS WILLIAM R. & CO. (C. C.
Gove), auction rooms, 32 E. Main, house
 12 Arnold park.—*See p. 507* [11 Hill
 Cavagnaro Louis, plaster paris worker, bds.
 Cavalliieri Bernhard, machinist, h. rear 72
 Franklin [N. Water, bds. York House
 Cavalo Michael, shoemaker, Andrews cor.
 Cavan James M. cutter, 44 Mill, house 54
 Court [Glasgow, h. 181 Exchange
 Cavanagh Joseph, laborer, Exchange opp.
 Cavanagh Sylvester, boot fitter, house 101
 Caledonia [Munger
 Cavanaugh Catharine, widow, boards 39
 Cavanaugh Margaret, widow, h. Frances near
 Marion
 Cavanaugh Mathew, removed from city
 Cavanaugh, see Kavanaugh

- Cawthra John (*Cawthra & Barnes*), h. Briggs' place near West avenue
- Cawthra & Barnes, (*J. Cawthra and E. Barnes*), carriage makers, Lake avenue corner White
- Cayford George, coachman, h. 13 William
- Cazeau Alfred, shade painter, h. Mt. Vernon avenue near Caroline
- Cazeau Charles, carpenter, Arcade, house 20 Trowbridge [Gregory]
- Cazeau Theodore H. clerk, 83 State, h. 2
- Ceares George, blacksmith, bds. 49 Lime
- Ceares Jacob, teamster, house 49 Lime
- Cecil Samuel, removed from city
- Censer Frank, messenger, 14 Exchange, boards 8 Concord avenue
- Central Library at Free Academy, Fitzhugh
- Chace Emory B. (*Cameron & Chace*), lumber, 19 Warehouse, h. 81 Lake av.
- Chaddock George W. blacksmith, 3 Canal, house 179 Brown [179 Brown]
- Chaddock William G. helper, 3 Canal, bds.
- Chadsey Helen, widow, house 73 S. Ford
- Chadwick Charles E. shoemaker, 92 State, boards Rowley cor. Brighton avenue
- Chadwick David I. & Co. flag walks, 57 State, boards 16 Clinton place [Paul]
- Chadwick Frank A. clerk, house 153 S. St.
- Chadwick Frank E. conductor, N. Y. C. R. R. house Edmonds corner Pearl
- Chadwick Henry D. clerk, 201 Monroe av. boards Pearl corner Edmonds
- Chadwick Jane E. boards 37 Savannah
- Chadwick John M. music teacher, 16 E. Main, house 105 Tremont [house do.]
- Chaffee David J. physician, 5 South Clinton
- Chaffey Francis, planemaker, h. 80 Court
- Chaffey Kate C. widow, boards 79 Court
- Chamberlain George F. deceased 1873
- Chamberlain George H. clerk, State corner Platt, boards 2 Frank
- Chamberlain George S. (*Chamberlain & Mordoff*), house 10 Frank
- Chamberlain Jenny E. house 57 Asylum
- Chamberlain John D. (*Chamberlain & Abbott*), Court corner Stone, h. 42 Reynolds
- Chamberlain Josephine, dressmaker, 42 Gorham, boards do.
- Chamberlain Osborn E. engineer, N. Y. C. R. R. house 51 Jay
- Chamberlain Permela, widow, boards 31 Reynolds [ers' bldgs. bds. 8 James]
- Chamberlain Philetus jr., student, 42 Pow
- Chamberlain William A. salesman, boards 10 Frank
- Chamberlain & Abbott (*J. D. Chamberlain and L. Abbott*), manufs. ladies' underwear, Court corner Stone
- C**HAMBERLAIN & MORDOFF (*George S. Chamberlain and M. C. Mordoff*), lumber yard, State corner Platt.—See page 624
- Chamberlin James R. rubber goods, 61 W. Main, house 57 Plymouth avenue
- Chambers Frank, mason, bds. 77 Tremont
- Chambers George, boards 16 Seward
- Chambers Robert W. (*Morse & Chambers*), 134 State, boards 116 West avenue
- Chambers Samuel D. gas fitter, board 116 North avenue
- Chambers Sarah, widow, house 15 Romeyn
- Chambers William H. fireman, boards 15 Romeyn [boards 29 Ward]
- Champagne Charles, cutter, 141 N. Water
- Champion David, laborer, house 14 Market
- Champion Sarah A. Mrs. house 8 Joslyn pk.
- Champney Anna, widow, house 41 Hamilton place [41 Hamilton place]
- Champney Court, clerk, 95 East Main, bds.
- Chmapney Edward, boards 133 Monroe
- Champney John A. salesman, 37 East Main, house Meigs near Monroe avenue
- Champney Thomas S. mail agt. E. R. R., house 131 Monroe avenue
- Chandler John H. fruit grower, house Rapids road near city line
- Chandler William F. student, University of Rochester, bds. 24 Manhattan [Paul]
- Champain David, laborer, house 29 S. St.
- Chapin Charles H. president Bank of Rochester, 41 State, house 77 Fitzhugh
- Chapin Desdemona, widow, bds. 187 Lyell
- Chapin Edward D. 60 State, house Hudson corner Norton [near rapids, house do.]
- Chapin Edwin B. glue manuf. Wolcott
- Chapin Louis, produce, 48 Powers' bldgs, house 72 Fitzhugh
- Chapin Louis S. salesman, bds. 33 Fitzhugh
- Chapin Lucy T. widow, house 8 Tremont
- Chapin William K. clerk, Bank of Rochester, 41 State, boards 77 Fitzhugh
- Chapin William W. bookkeeper, 31 State, boards 72 Fitzhugh
- Chaplin Naomi H. nurse, boards 44 Park av.
- Chapman Adad B. nursery stock, boards 17 Joslyn park
- Chapman Althea A. widow, house 37 Edinburgh [road near city line]
- Chapman Andrew B. farmer, house rapids
- Chapman Arthur, house 16 Cliff
- Chapman Bradley C. conductor, N. Y. C. R. R. house 187 North [Prospect]
- Chapman Charles A. cartman, boards 6
- Chapman Charles B. box maker, 57 State, boards 34 South Ford
- Chapman Charles H. fireman, house 25 Davis
- Chapman Charles S. printer, 82 West Main, house at Brighton
- Chapman Drucilla Miss, bds. 20 Park av.
- Chapman Edward, die maker, 129 Mill, h. 24 Vose
- Chapman Edna, boards 187 North
- Chapman Frank H. fireman, N. Y. C. R. R. boards 34 South Ford
- Chapman George, foreman, East av. near Culver, house at Brighton [22 Gorham]
- Chapman George jr. salesman, 74 Mill, house
- Chapman Herbert W. (*Granger & Chapman*), 19 Marietta, boards do.
- Chapman Julius, boards 144 West avenue
- Chapman Oliver, drayman, house 6 Prospect
- Chapman Pierpont, boards 17 Joslyn park
- Chapman Robert M. engineer, N. Y. C. R. R. house 38 Oak
- Chapman Roswell F. house 19 Marietta
- Chapman Smith, house 141 Alexander

Chapman Theodore (*Chapman & Stewart*), b. York House
 Chapman William, stonecutter, 8 West av. bds. avenue B near Conkey avenue
 Chapman & Stewart (*T. Chapman and J. E. Stewart*), children's shoes, 10½ Mill
 Chappell Asa W. boatman, h. Perkins cor. White alley [c. Fulton av.
 Chappell George D. machinist, b. Champion
 Chappell H. Oscar, removed to Penfield
 Chappell James K. h. 55 Plymouth av.
 Chappell Joseph H. brakeman, bds. 1 Tyler
 Chappell Oscar A. bracketmaker, house 9 Brisbane
 Chappell Wales H. b. Champion cor. Fulton avenue [cor. Fulton av.
 Chappell William B. teamster, h. Champion
 Chappell William N. porter, Whitcomb House
 Charles James M. removed from city
 Charles John H. car coupler, h. 43 Davis
 Charles Mary A. Mrs. vestmaker, b. 101 Kelly
 Charles William W. removed to Hornellsville
CHARLTON JOHN, nurseryman and florist, University avenue cor. Culver, house do.—*See page 527*
 Charman Alfred, carpenter, house 92 Jay
 Charters Sarah, widow, house 2 Lime
 Chartrain Gabriel, cabinetmaker, house 37½ Romeyn
 Chase Albert B. boards 57 Atwater
 Chase, Bristol & Viele (*J. H. Chase, M. F. Bristol and P. B. Viele*), Arcade Mills, 5 Aqueduct
CHASE BROTHERS (*Lewis, Ethan A. and M. V. B. Chase*), nurserymen and seedsmen, 1 East park.—*See page 526*
 Chase Daniel W. (*Chase & Otis*), boards 57 Chestnut [57 Atwater
 Chase DeForest W. policeman, City Hall, b.
 Chase Delia R. W. widow, h. 151 Plymouth avenue
 Chase Edward, removed to Newark, N. J.
 Chase Ethan A. (*Chase Brothers*), house 56 N. Union [h. 117 Clifton
 Chase George L. machine operator, 111 State,
 Chase James, machinist, h. 65 Charlotte
 Chase James E. machine operator, 4 Allen, boards 11 N. Fitzhugh
 Chase John A. dentist, 180 Powers' buildings, house at Avon [Hose House
 Chase John C. carrier, Post Office, b. Alert
 Chase John H. (*Chase & Richardson*), house 23 Frank
 Chase Lewis (*Chase Brothers*), house 2 East
 Chase Louisa, removed to Newark N. J.
 Chase Martin V. B. (*Chase Brothers*), house at Augusta, Me.
 Chase Mary Ann, widow, house 57 Atwater
 Chase Miller W. carpenter, house 9 Costar
 Chase Oliva C. widow, boards 2 Gibbs
 Chase Oren N. fish propagator, h. 46 Adams
 Chase Samuel, house 26 Greig
 Chase Samuel C. agent, boards 100 Mill
 Chase S. Everett, machine operator, 124 Front, house 8 Genesee
 Chase Therza, widow, boards 135 Plymouth avenue

CHASE & OTIS (*Daniel W. Chase and Lyman M. Otis*), lumber dealers, Court near Exchange.—*See page 653*
 Chase see Chase
 Chatfield Cornelia H. tailoress, boards 37 Reynolds [av. near Rapids
 Chatfield Egbert, carpenter, house Plymouth
 Chatfield Hannah S. Mrs. h. 37 Reynolds
 Chatfield Hiram H. carpenter, 39 S. Ford, h. 138 Adams [canal, h. 138 Adams
 Chatfield Isaiah H. sawyer, Jay corner Erie
 Chatfield Job W. mason, house 46 Bartlett
 Chatterton Margaret, widow, h. 6 N. Union
 Chauncey William G. farmer, h. 20 Cady
 Cheaunval Laura Miss, teacher, Pleasant near N. St. Paul, boards do.
 Cheeny Melissa, widow, b. 36 Champlain
 Cheeseman John M. painter, 69 State, h. 39 Tremont [Cliff, house 56 Bolivar
 Cheesman George, foreman oil works, foot
 Cheesman Richard W. clerk, 41 Monroe av. boards 39 Tremont [b. 39 Tremont
 Cheesman Robert, clerk, 64 West Main,
 Cheevers Nicholas, gardener, 39 Spring, b. do.
 Cheney A. Cole, manager, W. Union Telegraph office, 11 Arcade, h. 10 Upton pk.
 Cheney James E. salesman, b. Clinton Hotel
 Cheney James E. removed to Lancaster, O.
 Cheney James L. student, University of Rochester, bds. East av.
CHENEY WILLIAM H. architectural iron works, 106 S. St. Paul, h. 4 Livingston park.—*See page 652*
 Cherain Charles, teamster, h. 85 N. Clinton
 Cherry James, carpenter, boards 340 State
 Cherry John, doormaker, 13 Warehouse, h. Campbell near Whitney
 Cherry Martin, machinist, 6 Hill, boards 82 Orchard [house do.
 Cherry Mary, millinery, 162 West Main,
 Cherry Sabra, deceased May 7, 1876
 Cherry Walter, engineer, N. Y. C. R. R. h. 13 Joiner [Main, h. do.
 Cherry William E. bonnet bleacher, 162 W.
 Chester Thomas (*Smith & Chester*), Mill foot Brown, b. 9 Troup [166 Exchange
 Chesterton Charles H. waiter, 36 W. Main,
 Chesterton Frank, waiter, bds. 114 W. Main
 Chever George W. boarding, 37 Glasgow, house do.
 Child Benjamin A. carpenter, h. 38 Kirk
 Child Jonathan H. (*Child & Backus*), boards 11 North Washington
 Child & Backus (*J. H. Child and E. Backus*), plumbers, 117 W. Main
 Children's Home, 263 North St. Paul
 Childs David M. real estate, h. 19 N. St Paul
 Childs Frank L. carriage trimmer, ft. Centre, boards 24 Centre
 Childs John M. painter, boards 19 Joiner
 Chillson O. Augustus, agent, 75 State, house 70 Asylum [bds. 22 Allen
 Chipman Albert E. upholsterer, 74 State,
 Chipman Deborah, dressmaker, 22 Allen, house do.
 Chipman Frances Miss, bds. 101 Lake av.
 Chipman William P. student, Rochester Theological Seminary, b. Trevor Hall

Chiggs Joseph K. proprietor Ayers' Hotel,
82 Mill, house do. [4 N. Washington
Chisholm William, clerk, 17 State, boards
Chism Mary, widow, house 44 North Water
Chism Nellie, boards 44 North Water
Chittenden Hamilton V. boards 15 East
Christiney Thomas, laborer, h. 4 Dover
Chrip Hugh, driver, Elizabeth c. Hill, h. 65
Asylum
Christ Henry, laborer, h. Sibley n. Culver
Christ Henry, brewer, 139 N. St. Paul, h. 16
Almira
Christ Jacob, machinist, Brown's race foot
Furnace, house 12 Helena
Christ Joseph, machinist, Exchange opp.
Glasgow, boards 11 Swan
Christ Joseph, saloon, 32 Franklin, h. do.
Christ Jost C. mason, 50 Nassau, house do.
Christ Mary J. removed to San Diego, Cal.
Christ Susan, widow, house 12 Helena
Christiaansen Isaac (*Stroyer & Christiaansen*),
builders, 63 Asylum, house do.
Christiaansen John, house 65 Asylum
Christiaansen John M. carpenter, boards 63
Asylum
Christian Ann, widow, house 30 Orange
Christian Anna, widow, house 31 Hand
Christian Henry, moulder, 150 N. Water, h.
108 N. St. Paul
Christian John A. laborer, boards 44 Hunter
Christian Thomas H. teamster, b. 44 Hunter
Christian Wm. H. clerk, lunch room, Brackett
House, bds. do. [h. 90 Tremont
Christie Henry, stove-finisher, 187 W. Main,
Christie Jane, widow, h. 53 North av.
Christie John, stovemounter, h. 25 Comfort
Christie John, plasterer, b. 143 East Main
Christie Thomas, moulder, 187 West Main,
house 22 Griffth
Christie Thomas 2d, assistant weighmaster,
weighlock, boards 25 Comfort
Christie William, stove mounter, 187 West
Main, house 176 W. Main
Christman Amelia, tailoress, h. 69 Mt. Hope
avenue [Refuge, b. do.
Christman Matthew, overseer, House of
Christmann August, confectioner, 81½ West
av. bds. 100 Hunter [100 Hunter
Christmann Philip, foreman, 138 Mill, house
Christoph Joseph, tanner, 87 N. Water, h.
242 N. Clinton
Christy Arthur, foreman, house 17 Emmett
Christy Dyer M. student, Roch. Theological
Seminary, bds. Trevor Hall
Christy Thomas A. sawyer, Exchange opp.
Troup, b. 17 Emmett [12 Lawrence
Chrysler Pembroke G. agent, 18 Arcade, h.
Chuler Charles, turner, h. 262 N. Clinton
Chumasero Henry C. clerk, 93 State, boards
63 Court
Chumasero John C. (*Chumasero & Davison*),
156 Powers' buildings, house 63 Court
Chumasero & Davison (*J. C. Chumasero and
C. C. Davison*), lawyers, 156 Powers'
buildings
Church Home, 126 Mt. Hope avenue
Church John R. carpenter, b. 204 Monroe av.
Church Rudolph B. removed to Newark, N.J.

CHURCH SIDNEY, rope and twine manu-
facturer, 167 West avenue, house do.—
See page 670
Church Sophia, widow, b. 9. S. Washington
Churchill Arthur & Co. (*J. P. Humphrey,*
agt.), stoves, &c., 71 State, h. 36 Troup
Churchill Caroline, widow, house 13 North
Washington
Churchill Edward S. house 92 Fitzhugh
Churchill Frederick L. student, 31 State, b.
73 Plymouth avenue
Churchill Heman (*R. N. Wanfield & Co.*)
195 Monroe av. bds. 3 Maple pl.
Churchill Henry, nickel plating works, 122
Mill, house 3 North Washington
Churchill Henry L, bds. 3 N. Washington
Churchill Herbert Mrs. widow, house 13 N.
Washington
Churchill Lewis K. constable, h. 40 Atkinson
Churchill William, house 73 Plymouth av.
Churchill William W. b. 73 Plymouth av.
Chute Rose, widow, boards 71 Adams
Cirotzski August, saloon, 75 North av. h. do.
CITIZENS' GAS COMPANY, 15 North
St. Paul.—*See page 493*
City Bank of Rochester, 34 State
Clackner Andrew S. jeweler, 291 State, h. 36
Ambrose
Clackner Fred. E. removed to Brockport
Clackner Mary A. teacher, Franklin School,
No. 6, bds. 36 Ambrose
Claffey Charles, laborer, house 44 Munger
Claffey Mary, widow, house 72 Troup
Claffey Elizabeth, widow, house 19 Hand
Claffey Ellen A. Miss, dressmaker, 19 Hand,
boards do.
Clagg Tarleton, laborer, State c. Centre, bds.
38 Allen [St. Paul
Clague James J. shoecutter, boards 168 N.
CLAGUE, RANDALL & CO. (*W. H. Clague,*
R. B. Randall and E. R. Andrews),
machinists, 1 Aqueduct.—*See page 677*
Clague William H. pressman, 1 Aqueduct,
and (*Clague, Randall & Co.*), house 30 S.
Washington
Clancey John, mason, house 5 Emmett
Clancey John, deceased August, 1875
Clancey Michael, saloon, 94 Exchange, h. do.
Clancey Thomas, foreman, 54 Fitzhugh, h.
5 Granger
Clancy Amelia, widow, h. Goodman n. R.R.
Clancy Charles A. removed to Philadelphia
Clancy David D. foreman, house 2 Clarissa
Clancy Elizabeth Mrs. house 2 Mumford
Clancy James, mason, house 121 Hunter
Clancy John L. painter, bds. 84 N. St. Paul
Clancy John M. clerk, boards 13 George
Clancy Mary, widow, house 1 Shamrock
Clancy Mary A. widow, house 13 George
Clancy Richard, laborer, house 44 Weld
Clapp Eliza J. widow, house 15 Meigs
Clapper Enoch, house 18 Kent
Clapper Hattie J. Miss, music teacher, bds.
18 Kent
Clare Joseph, machinist, h. 91 Broadway
Clare Sister, teacher, boards Jay c. Frank
Clarey Annie, domestic, Osburn House
Clark Alfred, laborer, house 19 Thompson

- Clark Amelia P. widow, h. Jones c. Lyell
 Clark Ann E. widow, h. 102 Caledonia av.
 Clark Belle Miss, boards Whitney place
 Clark Bracket H. stove manufacturer, Lyell cor. Erie canal, house 57 Lake av.
 Clark Catharine, widow, house 1 Dean
 Clark Charles, wireworker, 79 State, bds. 85 Adams
 Clark Charles, bartender, 133 W. Main, h. do.
 Clark Charles A. deputy collector, custom house, 31 State, bds. 41 Clinton place
 Clark Charles H. machinist, h. 9 Anson park
 Clark Charles H. machinist, b. 90 Alexander
 Clark Chauncey W. 100 State, h. 19 Sophia
 Clark Cortland, express messenger, house 68 North Chatham
 Clark Curtis (*Ward & Clark*), insurance agt. 31 Powers' bldgs. house 132 Alexander
 Clark Daniel R. (*Osgood & Clark*), 4 Front, bds. 57 Lake av.
 Clark David, blacksmith, 2 Ely, bds. 1 do.
 Clark David, machinist, h. 223 North [96 do.
 Clark David, painter, 100 S. St. Paul, bds.
 Clark Delia Miss, house 6 Brigg's block
 Clark Eber R. clerk, 102 West avenue, house 6 New York
 Clark Edith A. forewoman, b. 25 Stillson
 Clark Edmund F. secretary Buffalo Steam Gauge and Lantern Co. 13 Warehouse, boards 61 East avenue
 Clark Electa, widow, house 12 Fitzhugh
 Clark Elizabeth, boards 200 Brown
 Clark Elizabeth, dressmaker, boards 23 Jay
 Clark Elizabeth, widow, house 79 Adams
 Clark Elizabeth G. widow, boards 12 Seward
 Clark Ellen, widow, house 53 Hunter
 Clark Florence P. music teacher, b. 79 Adams
 Clark Frances A. Miss, boards Whitney pl.
 Clark Frank, salesman, 24 State, h. at Minneapolis, Minn. [E. Main
 Clark Frank E. Mrs. music teacher, h. 102½
 Clark Frederick W. printer, 57 State, house rear 1 Fulton avenue
 Clark George, waiter, 28 Exchange, bds. do.
 Clark George, clerk, W. Main cor. S. Washington, boards 65 Tremont
 Clark George C. screw manufacturer, 123 Mill, house 8 Saratoga avenue
 Clark George H. clerk, Lyell c. Erie canal, boards 57 Lake avenue
 Clark George H. baggageman, N. Y. C. R. R. house 15 Stehney's park
 Clark George S. coachman, house 9½ Spring
 Clark George W. shoemaker, 55 Magne, house do.
 Clark George W. engineer, house 56 Saxton
 Clark Godfrey B. boards 33 Court
 Clark Goodhand, carman, house 77 Tremont
 Clark Heman, salesman, house 73 Troup
 Clark Henry B. finisher, 155 N. Water, house Hollister near Channing
 Clark Henry D. agent, house 3 Helena
 Clark Herbert L. sleeping car conductor, boards Congress Hall
 Clark Hugh, policeman, City Hall, boards 165 Brown [house 38 Franklin
 Clark Ira S. news depot, Allen corner Oak,
 Clark James, waiter, Osburn House
 Clark James, laborer, house 49 Savannah
 Clark James A. clerk, 17 W. Main, bds. 7 Clinton place
 Clark James L. teamster, h. Edward n. Vose
 Clark Jas. P. clerk, 101 Whitney, b. 108 do.
 Clark James W. saloon, 129 State, h. 127 do.
 Clark Jane Mrs. saloon, 143 W. Main, h. do.
 Clark Jeremiah, boarding house, house 102½ East Main
 Clark John, peddler, 144 East Main
 Clark John, laborer, house 37 Monroe avenue
 Clark John, laborer, Lyell cor. West, house 108 Whitney near Lyell
 Clark John, grocer, 111 Hunter, house do.
 Clark John jr. (*Clark & Clark*), 98 Powers' buildings, bds r. 284 State [bds. do.
 Clark John A. (*Samuel Hart & Co.*), 333 State,
 Clark John W. compositor, 23 W. Main, b. University av. opp. Upton park
 Clark Julia, boarding, house 117½ E. Main
 Clark J. Wayland, student, University of Rochester, bds. 58 Monroe av. [n. Wall
 Clark Kelly E. peddler, house W. Troup
 Clark Lavina, widow, house 70 Clifton
 Clark Lucina, nurse, house 1 Tracy park
 Clark Lucinda B. widow, house r. 284 State
 Clark Lucy H. teacher, Concord School No. 18
 Clark Maria B. Mrs. house 47 North avenue
 Clark Mary A. widow, house 50 Saxton
 Clark Mary J. widow, house Child's alley near Erie canal
 Clark Mary J. removed to Penfield
 Clark Mary J. Miss, house 33 Sophia
 Clark Michael, bricklayer, boards 308 State
 Clark Millicent, widow, house 13 Sophia
 Clark Morris W. removed from city
 Clark Orlando E. student, University of Rochester, boards 28 Pearl
 Clark Paris G. (*Clark & Clark*), 98 Powers' buildings, house 117 Fitzhugh
 Clark Patrick, yardman, 7 Plymouth avenue, house 64 Tremont.
 Clark Samuel M. physician, 219 N. Clinton
 Clark Susie, domestic, 43 Lake avenue
 Clark Sylvester C. confectioner, Pindell al. house 9 Vine
 Clark S. Mrs. nurse, house 9 South avenue
 Clark Thomas, tailor, House of Refuge, house at Batavia
 Clark Thomas, teamster, 163 Exchange, h. rear 17 Sanford [h. 79 Chatham
 Clark Thomas D. scalemaker, 3 Andrews,
 Clark Thomas J. morocco finisher, 321 North St. Paul, bds. N. St. Paul opp. Norton
 Clark Thomas R. salesman, 14 W. Main, boards 147 Plymouth avenue
 Clark Willard, boatman, h. 143 W. Main
 Clark William, picture dealer, b. 2 Spencer
 Clark William, waiter, Osburn House
 Clark William H. bookkeeper, 50 Exchange, house 90 Alexander
 Clark William H. plumber, boards 152 Scio
 Clark William J. cutter, 14 Mumford, house 152 Scio
 Clark William M. C. painter, h. 80 S. St. Paul
 CLARK WILLIAM N. fruits and groceries, 120 W. Main, house Hollenbeck corner Norton. — See page 554

- Clark William O. removed to Penfield
 Clark William V. bookkeeper, 136 Mill, h. 7 Scrantom
 Clark W. Desalvo, carriagemaker, rear 145 East Main, house 18 Park avenue
 Clark & Clark (*Paris G. and John Clark jr.*), lawyers, 98 Powers' buildings
 Clarke Archie S. (*H. C. Roberts & Co.*), 17 Powers' buildings, bds. 5 Livingston pl.
 Clarke Charles E. boards 29 Lancaster
 Clarke Dora E. teacher, Franklin School, No. 6, boards 12 Fitzhugh
 Clarke Edward S. student, b. 110 Alexander
 Clarke Edward W. watchman, Aqueduct, house 28 Hunter [56 Monroe avenue
 Clarke Elias A. physician, 128 State, house
 Clarke Eliza, widow, house 12 Chatham
 Clarke Freeman, 31 State, h. 110 Alexander
 Clarke F. De Witt, treas. Buffalo Steam Gauge and Lantern Co. 31 State, house 61 East avenue
 Clarke George H. boards 110 Alexander
 Clarke James T. compositor, 3 W. Main, house 48 Pearl [85 Adams
 Clarke John, shoemaker, 223 W. Main, h.
 Clarke Joseph E. news agent, N. Y. C. R. R. Centre cor. Mill, boards 65 Tremont
 Clarke L. Ward, treasurer Rochester Printing Co. 3 West Main, bds. 23 East avenue
 Clarke Robert J. H. moulder, 20 Court, bds. 6 Madison park
 Clarke Roswell, deceased, May, 1875
 Clarke Sherman, bds. 110 Alexander [park
 Clarke William C. boatbuilder, h. 6 Madison
 Clarke Wm. T. cutter, h. 247 E. Main
 Clarkson Alonzo R. bookkeeper, 54 W. Main, house 1 George
 Clarkson Frank M. civil engineer, water works, City Hall, h. 86 East avenue
 Clarkson George G. merchant tailor, 54 West Main, house 27 North St. Paul
 Clarkson Thomas, clérk, Platt cor. Kent, h. 319 State
 Classeu John, tailor, house 4 Kirk
 Claus Elizabeth, widow, h. 33 Brown's alley
 Claus John, teamster, bds. 33 Brown's alley
 Claver Albert, clerk, house 105 Hudson
 Claver Bertha, widow, house 15 Tyler
 Claver Gerritt, carriage painter, 167 W. Main, boards 15 Tyler
 Claver John, framemaker, bds. 8 Wilder
 Claver John C. tailor, 17 Front, house 12 Huntington
 Clay Frank, carpenter, h. 13 Phelps avenue
 Cleary Bridget, domestic, bds. 70 Lake av.
 Cleary Catharine, widow, house 13 Webster
 Cleary John, laborer, house 53 Weeger
 Cleary John, mason, house 20 Orchard
 Cleary Joseph P. policeman, City Hall, h. 11 Caledonia avenue [near Julia
 Cleary Margaret, widow, b. Waverly place
 Cleary Michael, laborer, house 15 Webster
 Cleary Thomas, laborer, bds. 33 Frank
 Cleggett Isaac, coachman, 13 S. Washington, house 30 Plymouth avenue
 Cleggett Wm. coachman, 25 S. Clinton, h. 57 Monroe av. [Mill, h. 14 Bolivar
 Clement Frank H. (*Turner & Clement*), 122
 Clement John, butcher, b. Jay c. Orchard
 Clement Lydia A. b. East av. c. Alexander
 Clement Mary Sister, teacher, St. Patrick's Orphan Asylum
 Clement Richard, boards 17 Oregon
 Clement Sarah J. widow, h. 17 Oregon
 Clementian Brothers, St. Patrick's Academy, Brown cor. Frank
 Clements Caroline, saloon, 72 Exchange, h. do.
 Clements John, grocer, house 11 Lyell
 Clements John, foreman, h. 90 West avenue
 Clements Lucia Mrs. matron, Rochester Orphan Asylum, Hubbel park, boards do.
 Clements Thomas, machinist, 3 Canal, house 14 do.
 Clements Thomas, mason, h. 75 Bolivar
 Clements Wm. clerk, 28 Allen, bds. 11 Lyell
 Cleminson Mary A. Mrs. proprietor York House, Front cor. Market, house do.
 Clemons Samuel P. chiroprapist, Harvard cor. Goodman, house do.
 Cleveland Benjamin P. clerk, 119 W. Main, house 10 Foehner
 Cleveland C. Augustus, boot manuf. 7 South St. Paul, house 99 Monroe av.
 Cleveland Henry B. & Co. (*J. A. Taylor*), commission merchants, 119 West Main, house 8 Foehner [h. 103 Monroe av.
 Cleveland John, cutter, 7 South St. Paul,
 Cleveland Martha, bookkeeper, boards 31½ Chestnut [Main, h. 2 Howell
 Cleveland Seth D. W. bookkeeper 80 East
 Cleveland William, conductor, N. Y. C. R. R. house 79 Tappan
 Clevenger Galen S. student, Rochester Theological Seminary, bds. Trevor Hall
 Clickner John D. carpenter, h. 96 State
 Clifford Abbie J. Mrs. dressmaker, h. 13 Ely
 Clifford Orilla B. widow, house 72 Munger
 Clifford Stephen, laborer, house 53 Adams
 Clifton Edward, reporter, Union & Advertiser, 82 W. Main, boards 21 Sophia
 Climaca J. teacher, St. Joseph's Orphan Asylum [Orphan Asylum
 Climacus Mary Sister, teacher, St. Patrick's
 Clinch Peter (*Spencer, Stalker & Clinch*), 104 East Main, house 35 George
 Cline Charles A. student, boards 5 Scio
 Cline Jay B. tree agent, house 10 Howell
 Cline John, house 5 Scio
 Cline John A. contractor, h. 26 Saratoga av.
 Cline Joseph, tucker, house 16 Smith
 Cloonin Bridget, widow, house 3 Drayton
 Cloonin Daniel, laborer, boards 3 Drayton
 Cloonin James, laborer, boards 3 Drayton
 Cloonin Matthew, removed to Buffalo
 Close Ernest M. (*Close & Yost*), h. 35 Comfort
 Close James E. removed from city
 Close & Yost (*E. M. Close and O. H. Yost*), auctioneers, 2 E. Main
 Clough Charles, moulder, 8 Hill, b. 8 N. Ford
 Clough Diadama, widow, boards 153 Wilder
 Clough Rosalie K. Mrs. removed to Sacramento, Cal.
 Clow Ann E. Mrs. boards 7 Alexander park
 Clum Philip A. moulder, Court c. Stone, b. Frances n. W. Troup [278 State
 Clump George, porter, Waverly House, h.

Clunan James, teamster, 57 Fitzhugh, house 58 Adams
 Clune Anna, hairdresser, boards 46 Smith
 Clune John H. painter, boards 46 Smith
 Clune Margaret, boards 28 Stone
 Clune Michael, house 46 Smith [boards do.
 Clute Charles W. clerk, Chapman House,
 Clute Edgar C. salesman, boards 73 Tappan
CLUTE GEORGE H. proprietor Chapman House, 44 S. St. Paul, h. do.—*See page 567*
 Clute Salina, widow, house 73 Tappan
 Coake Cornelius, shoemaker, 8 E. Main, h. 37 Tappan
 Coake James, soap maker, house 15 Kirk
 Coakley Johannah D. Mrs. house 26 Smith
 Coakley Lotta, music teacher, b. 26 Smith
 Coakley Michael J. machinist, Brown cor. Jones, boards 26 Smith
 Coakley Prudence J. teacher, b. 26 Smith
 Coapman Edgar, machinist, West cor. Lyell, house 24 Lorimer [20 Lake av.
 Coapman Edgar A. clerk, 264 State, house
 Coapman John A. engineer, h. 23 Lorimer
 Coates George, machinist, 55 Mill, h. 10 Lyell
 Coates Geo. R. clerk, 13 E. Main, b. 10 Lyell
 Coates Geo. W. driver, h. 13 Waverly place
 Coates John R. steward, National Hotel, h. 1 Park place
 Coats Adelbert S. student, Rochester Theological Seminary, boards Trevor Hall
 Coats Russell, liquors, 9 Exchange, boards European Hotel
 Coats Thomas E. removed from city
 Cobb Benjamin F. roofer, h. 106½ W. Main
 Cobb Charles, salesman, boards 80 Kent
 Cobb Cullen R. cartman, house 80 Kent
 Cobb John F. removed from city
 Cobb Josiah, house 106½ West Main
 Cobb Lucy E. widow, house 31 Hill
 Cobb Nichelina Mrs. house 9 Jay
 Cobbs Robert, scavenger, house 90 Front
 Cobleigh A. M. dancing school, 211 Powers' buildings
 Coble Henry, tinsmith, boards 7 Hand
 Cochenour Francis, sawyer, rear South St. Paul opp. Griffith, h. 3 Alexander park
 Cochlin Ann, widow, boards 52 Spring
 Cochoy Rudolph, upholsterer, 7 N. Water, house 7 Nassau
 Cochran Joseph A. agent, h. 20 Lawrence
 Cochran Jos. E. removed to Meadville, Pa.
 Cochrane Charles, grocer, 149 North Clinton, house do.
 Cochrane Eliza Miss, boards 89 Tappan
 Cochrane James, clerk, County clerk's office, house 54 Monroe avenue [50 Spring
 Cochrane James C. lawyer, 90 West Main, h.
 Cochrane Jeremiah, laborer, house Childs alley near Erie canal
 Cochrane John, laborer, house 48 Thompson
 Cochrane Mary E. Mrs. boards 36 Adams
 Cochrane Michael, morocco finisher, 37 N. Water, house 9 Cady
 Cochrane William, grocer, 69 Jay, house do.
 Cochrane William J. sailmaker, house rear 36½ Gregory [bds. do.
 Cockburn Trumble, waiter, Clinton Hotel
 Cocker John, grinder, 136 Mill, b. 50 Allen

Cocklin John, cigar maker, Magnolia near Genesee, house do.
 Codding Milo D. house 70 Sibley's block
 Codding Thayer H. house 16 Tracy park
 Codding William T. watchmaker, Court cor. Stone, house 54 Savannah
 Codding Wm. T. deceased March 12, 1876
 Cody Jane, widow, house 111 Jay
 Cody Mary, tailoress, bds. 242 N. Clinton
 Cody Peter, blacksmith, h. 242 N. Clinton
 Cody Peter jr. shoemaker, house 40 Martin
 Cody William F. actor, bds. 10 New York
 Coffee Bridget, stitcher, bds. 62 St. Joseph
 Coffee Daniel, moulder, boards 16 Emmett
 Coffee Edward, removed to Palmyra
 Coffee Lyman, cigar manufacturer, 87 Front, house 22 Jones
 Coffee Margaret, widow, house 58 Jones
 Coffee Michael, house 167 Alexander
 Coffey Ann, widow, house rear 28 Stone
 Coffey Elizabeth, widow, house 16 Emmett
 Coffey James, laborer, house 17 Orchard
 Coffey Jeremiah, helper, 29 Exchange, boards 16 Emmett
 Coffey John, moulder, boards 16 Emmett
 Coffey John, engineer, boards 62 St. Joseph
 Coffey Margaret, dressmaker, b. 16 Emmett
 Coffey Mary, tailoress, boards 16 Emmett
 Coffey Thomas, laborer, boards 17 Orchard
 Coffin William H. deceased November, 1875
COFFIN W. H. MRS. dress and cloak maker, 24 East Main, h. 39 Saxton.—*See page 546*
 Cogar Margaret, widow, house 21 Favor
 Cogar Wm. H. carver, 8 Allen, b. 21 Favor
 Coghlan Allen, clerk, 105 State, boards 3 George's park
 Coghlan Ann, widow, h. 3 George's park
 Coghlan Mary, widow, boards 60 Clifton
 Coghlan Thomas, shoemaker, Andrews corner N. Water, boards Reed House
 Cogswell Charles H. produce, 10 Plymouth avenue, house 16½ Magne [bds. do.
 Cogswell Eliza, dressmaker, 4 Trowbridge,
 Cogswell George W. machinist, h. 9 Granger
 Cogswell Jane, widow, house 4 Trowbridge
 Cogswell Pierce J. agent, 42 Arcade, boards 22 Elm [Frank
 Cogswell Wm. A. sup't, 116 Mill, house 3
 Cogswell William F. (*Cogswell & Perkins*), 18 Powers' bldgs. h. East av. cor. Prince
 Cogswell William N. student, University of Rochester, bds. East av. cor. Prince
 Cogswell & Perkins (*W. F. Cogswell and J. B. Perkins*), lawyers, 18 Powers' bldgs.
 Cohen Jacob, tailor, 40 E. Main, h. 44 Joiner
 Cohn Henry S. (*H. C. Cohn & Co.*), boards 58 Court [b. 58 Court
 Cohn Herman C. & Co. neck ties, 71 Mill
 Cohn Joseph, laborer, h. 5 McDonald av.
 Cohn Solomon, clothing, 35 E. Main, house 58 Court
 Coit Charles P. pastor Hudson st. Memorial Church, house 44 Concord av.
 Cokely John, deceased August, 1875
 Cokely Margaret, widow, house 58 Joiner
 Cokely William T. machinist, bds. 58 Joiner
 Colbert Edward, laborer, house 51 Munger

- Colbert John, blacksmith, h. 361½ Munger
 Colburn George, engineer, N. Y. C. R. R. house 85 Jay
 Colby Sarah, boards 252 North St. Paul
 Colby Zaccheus jr. gardener, house Genesee near Seward
 Cole Abraham, removed to Montrose, Pa.
 Cole Albert F. house 26 Kelly
 Cole Alonzo W. salesman, 24 State, house 6 Park avenue [Lawrence
 Cole Anthony, policeman, City Hall, house 9
 Cole Austin H. (Moore & Cole), 72 W. Main, house 85 Troup
 Cole Clarissa I. Mrs. widow, h. 83½ Fitzhugh
 Cole Delos, laborer, h. Champlain n. Genesee
 Cole George H. teamster, h. 168 West avenue
 Cole Horace, removed to Syracuse
 Cole James J. laborer, house 121 Childs
 Cole James W. boards 83½ Fitzhugh
 Cole James W. hostler, h. 149 South avenue
 Cole John D. moulder, 150 North Water, b. 38 Platt
 Cole John E. land agent, 2 Pleasant, h. do.
 Cole Lucy A. widow, boards 26 Kelly
 Cole Otis, house 16 Atwater
 Cole Richard D. removed to Irondequoit
 Cole Ross P. salesman, 36 Exchange, boards 36 Fitzhugh [169½ E. Main
 Cole Spencer, teamster, 11 West Main, bds.
 Cole Thomas, moulder, Court corner Stone, boards 203 State [boards 16 Atwater
 Cole Wray L. clerk, gas works, Mumford, Colegrove Louisa Mrs. boards 49 Platt
 Coleman Alexander, carpenter, h. 14 Cole
 Coleman Benjamin W. porter, Osburn House, house West alley near Spring
 Coleman Charles E. waiter, Osburn House, house West alley near Spring
 Coleman Emory, student, University of Rochester, boards 77 Atwater
 Coleman George, farmer, h. Goodman n. Bay
 Coleman Henry A. boards 12 Gorham
 Coleman John E. student, University of Rochester, boards 75 Atwater
 Coleman Joseph, blacksmith, house Lincoln near city line [b. Osburn House
 Coleman Mary, laundress, r. 14 N. St. Paul,
 Coleman Peter, laborer, Charlotte junction, house 3 Murray
 Coleman Raynor, varnisher, 184 State, bds. 3 Murray [Madison, house do.
 Coleman Stephen, novelty supply comp'y, 16
 Coleman Stephen G. flagman, N. Y. C. R. R. boards Rowe near city line
 Coleman William H. porter, Osburn House
 Coley William, clerk, 143 State, boards 12 Elizabeth
 Colgrove Louise, nurse, boards 49 Platt
 Collamer Emma, widow, house 42 Kent
 Collamer Job, machinist, Brown cor. Jones, boards 42 Kent
 Collamer William G. clerk, boards 42 Kent
 Collar Mary H. Mrs. bds. 41 North avenue
 Coller Martha A. widow, bds. 22 Arnold pk.
 Collet Charles, artist, 107 Arcade, bds. 2 Elm
 Collet Peter, moulder, 8 Hill, h. 51 Childs
 Collett Thomas, laborer, 188 State, house 115 Chatham
 Collier Morey S. student, University of Rochester, b. 10 St. Joseph
 Collins Alphonzo, conductor, N. Y. C. & H. R. R. house 16 Fitzhugh
 Collins Ann, widow, house rear 18 Cliff
 Collins Anna (Collins & Morgan), h. 101 Mill
 Collins Anna H. teacher, Wadsworth School No. 12, boards 42 Chestnut
 Collins Bridget A. dressmaker, b. 45 Campbell
 Collins Calvin, boards 16 Fitzhugh
 Collins Catharine, widow, h. 132 St. Joseph
 Collins Catharine H. tailorress, bds. 223 Plymouth avenue
 Collins Charles E. brass finisher, b. 27 Platt
 Collins Charles H. brass moulder, 109 Mill, boards 36 North Washington
 Collins Christina, seamstress, bds. 25 Lime
 Collins Daniel J. deceased April 17, 1876
 Collins Daniel R. plumber, 15 West Main, boards 223 Plymouth avenue
 Collins Dennis, laborer, bds. Centre cor. Mill
 Collins Dennis, farmer, house 62 Wilder
 Collins Edward J. shoemaker, 4 Allen, house 97 Adams [h. 51 Andrews
 Collins Elihu B. clerk, 100 South St. Paul,
 Collins Elizabeth, widow, house 25 Lime
 Collins Elizabeth, seamstress, bds. 25 Lime
 Collins Fitch B. salesman, 14 West Main, b. 39 North St. Paul
 Collins Frederica, seamstress, b. 18 Bolivar
 Collins Frederick W. hops, 27 Madison, h. do.
 Collins George, carriage maker, 3 Canal, b. 25 Lime
 Collins George, engineer, h. 52 W. Smith
 Collins Geo. W. sawmaker, 153 State, boards 27 Platt
 Collins Henry C. & Co. (S. Boughton), grain, 2 Plymouth avenue, house 55 Adams
 Collins Hiram L. clerk, 2 Plymouth avenue, boards 55 Adams
 Collins James, laborer, h. Culver n. railroad
 Collins Johanna, widow, house 18 Bolivar
 Collins John, waiter, Congress Hall, bds. do.
 Collins John, mason, house 19 Goodman
 Collins John E. carriagemaker, 3 Canal, bds. 25 Lime [45 Campbell
 Collins John H. salesman, 184 State, house
 Collins Julia, widow, h. Bartlett n. Reynolds
 Collins Maria J. boards 7 Clinton place
 Collins Martin, switchman, house 39 Lewis
 Collins Mary, widow, house 27 Platt
 Collins Matthew, servant, Osburn House
 Collins Patrick, laborer, house 61 Lime
 Collins Richard D. stonecutter, house 223 Plymouth avenue
 Collins Sarah, widow, house 107 Adams
 Collins Stephen, sawyer, h. 130 Fulton av.
 Collins Thaddeus W. jr. student, University of Rochester, bds. 80 Court
 Collins Thomas, salesman, 153 East Main, bds. 5 Franklin sq. [h. 42 Chestnut
 Collins Thomas B. physician, 74 East Main,
 Collins William, laborer, house 5 George's pk.
 Collins Winnifred, widow, house 77 Cady
 Collins & Morgan (A. Collins and C. Morgan), prop'rs Behm's Hotel, 101 Mill
 Collinson Charles A. tinsmith, 2 Ely, boards 13 Marshall

Collinson William, hackman, h. 13 Marshall
 Collinson Wm. jr. machinist, b. 13 Marshall
 Collister Lyman, removed to Kansas
 Collister Royce R. boards 38 Delevan
 Collister William, carpenter, Minerva alley,
 boards 39 William [4 Frederick
 Collyer Abraham, clerk, 210 E. Main, house
 Colper Abel, teamster, house University av.
 near Culver
 Colson Catharine Mrs house 27 South Ford
 Colter Pelagie, widow, house 23 Howell
 Colton Reuben W. clerk. 4 W. Main, house
 84 State [h. 21 Hawkins
 Columbus George, shoemaker, 73 N. Water,
 Columbus Minnie, tailoress, b. 21 Hawkins
 Colvin Clarinda T. bds. Wolcott n. city line
 Colvin Aldrich, clerk, 4 East Main, bds. do.
 Colvin Henry T. carpenter, house 5 Huron
 Colvin Stephen R. real estate, 38 Arcade, bds.
 117½ East Main
 Colvin Varnum M. principal, Atwater School,
 No. 10, house 8 Palmer's block
 Colvin William M. notary public, Traders'
 National Bank, 35 W. Main, boards 66
 Chestnut
 Colvin Zorada J. widow, house 66 Chestnut
 Colwell John A. lawyer, 90 W. Main, house
 Mt. Hope av. near Mt. Hope Cemetery
 Combs Alexander J. tobacconist, 2 South St.
 Paul, house do. [shall
 Combs Edgar S. clerk, 4 E. Main, b. 47 Mar-
 Combs Lena, stitcher, boards 36 Platt
 Combs Mary J. widow, bds. 26 Saratoga av.
 Combs Mary J. widow, house 47 Marshall
 Combs, see Coombs
 Comens Carlos, printer, bds. 31 N. St. Paul
 Commercial Bank, 31 West Main
 Comerford James G. bookkeeper, 58 State,
 bds. 66 Franklin [Anderson av.
 Command John, boiler maker, boards 22
 Commarford Mary A. widow, h. 90 Adams
 Commons George jr. teamster, h. 68 Frances
 Commons John, moulder, Court cor. Stone,
 house 7 Trowbridge
 Commons Margaret, widow, boards 28 Oak
 Comons William, carriagemaker, 6 Plymouth
 avenue, house 115 Tremont
 Comstock George, painter, h. 11 Waverley pl.
 Comstock Orville, house 55 Atkinson
 Conant Cornelius B. watchman, 73 Alexan-
 der, house 100 Pearl corner Meigs
 Conat Hiram A. agent, boards 58 Kent
 Conboy James H. laborer, Frost av. corner
 Olean, h. Cottage n. Plymouth av.
 Condlin Frank, tinsmith, 65 Exchange, bds.
 70 Tremont
 Condlin Margaret, widow, house 70 Tremont
 Condlin Mary J. laundry, 111 E. Main, bds.
 70 Tremont [Caledonia av.
 Condon Catharine, dressmaker, boards 83
 Condon Charles, blacksmith, 124 Mill, house
 30 Lyell
 Condon Mary, widow, h. 83 Caledonia av.
 Cone Edward A. clerk, 59 Powers' bldgs. h.
 39 Exchange
 Cone Eva A. boards 72 Kent
 Cone John C. bookkeeper, Allen cor. North
 Washington, boards 34 Bolivar

Cone Sarah E. widow, house 34 Bolivar
 Cone William H. (Cone & Kendall), boards
 89½ Frank
 Cone William H. engineer, N. Y. C. R. R.
 house 64 Chatham
 Cone & Kendall (W. H. Cone and L. S. Ken-
 dall), gents' furnishing goods, 11 E. Main
 Conearty Edward, painter, boards 19 Joiner
 Conegan Bernard, house 4 Shamrock
 Conegan Malachi E. machinist, boards 4
 Shamrock [man
 Coner Andrew, clerk, h. Caroline n. Good-
 Congdon Bridget Mrs. h. r. 112 East avenue
 Congdon Henry H. carpenter, b. 2 Arlington
 Congdon William G. bookkeeper, Mill cor.
 Mumford, house 2 Arlington
 Conkel John G. machinist, Court cor. Stone,
 house 82½ Hunter
 Conkey Nellie A. teacher, Carthage School,
 No. 8, boards 264 North St. Paul
 Conkey Sarah A. widow, house 17 East av.
 Conkey Susan, widow, h. 264 N. St. Paul
 Conklin Elizabeth P. J. teacher, b. 3 Oak
 Conklin James F. house 9 Lorimer
 Conklin Mary S. Miss, boards 2 Pleasant
 Conlan Adelbert, laborer, h. 12 Hebard
 Conlan Elizabeth Miss, boarding house, 54
 Allen
 Conlan Sarah Miss, b. 149 North Union
 Conlin Daniel, laborer, removed to Spencer-
 port [Paul
 Conlon James E. boatman, b. 21 South St.
 Connal Eliza J. widow, house 42 Hickory
 Connal John W. clerk, boards 42 Hickory
 Connal Robert M. boards 42 Hickory
 Connaughton Ellen, widow, h. Peach alley
 near Atkinson
 Connaughton Peter, saloon, 5 Hunter, h. do.
 Connell Alice, widow, h. 26 Vincent place
 Connell Charles H. painter, 22 S. St. Paul,
 b. Wilder c. Whitney
 Connell Dixon R. harness maker, 102 East
 av. h. Anderson av. n. Fairmount
 Connell Edward, laborer, boards Flint near
 Reynolds
 Connell Ellen, widow, house 50 Childs
 Connell James, laborer, b. Flint n. Reynolds
 Connell James, boots and shoes, 73 Lyell, h.
 do. [place
 Connell James, carpenter, bds. 26 Vincent
 Connell John (Connell & Dengler), house 4
 Oregon [Jones
 Connell John, blacksmith, 3 Canal, house 21
 Connell John, blacksmith, 3 Canal, house 70
 Jay [Reynolds
 Connell Joseph, quarryman, house Flint n.
 Connell Louisa J. teacher, Genesee School,
 No. 4, boards 73 Lyell
 Connell Patrick, carpenter, b. 26 Vincent pl.
 Connell Thomas, printer, 82 W. Main, b. 4
 Oregon
 Connell Thomas, saloon, 63 West avenue,
 boards 54 Hunter
 Connell Thomas R. laborer, Brown c. Jones,
 house 6 Julia
 Connell Timothy, laborer, h. 68 West avenue
 Connell William, stonecutter, boards Flint
 near Reynolds

CONNELL & DENGLE (*J. Connell and V. Dengler*), wood working machinery manufacturers, Mill corner Furnace.—
See opposite page 551
 Connelly Edward, watchman, house Childs near N. Y. C. R. R.
 Conner Morris H. removed from city
 Conner James, shoemaker, 83 North Water, house 1 Ward [do.
 Conner Michael, saloon, 160 S. St. Paul, h.
 Connolly Andrew, policeman, City Hall, h. 7 Lawrence
 Connolly Bartholomew, switchman, boards 13 Webster [n. Maple
 Connolly Frank, blacksmith, house Childs
 Connolly George W. & Co. gasfitters, 153 E. Main, house 24 Leopold
 Connolly James, laborer, b. 139 S. St. Paul
 Connolly John, tailor, house 3 Tremont
 Connolly John C. steam fitter, 25 Exchange, h. 54 Charlotte [b. 8 Magne
 Connolly John W. machinist, 1 Aqueduct,
 Connolly Joseph, rubber, 3 Canal, house 72 West avenue [shall
 Connolly Julia, music teacher, bds. 17 Mar-
 Connolly Katie, stitcher, boards 8 Magne
 Connolly Michael, laborer, house 3 Baden
 Connolly Morris, deceased, April 30, 1876
 Connolly Patrick, laborer, 138 Mill, house 18 Terry [h. 63 Alexander
 Connolly Patrick, salesman, 53 East Main,
 Connolly Thomas, plumber, 96 E. Main, bds 5 Lancaster
 Connolly Thomas, laborer, h. Myrtle corner Otis [15 Savannah
 Connolly Thomas, plumber, 153 E. Main, b.
 Connolly William H. brakeman, house 52 Whitney
 Connolly see Conolly
 Connor Ann, widow, boards 163 Alexander
 Connor Charles, flour packer, Washington Mills, b. 10 Smith [h. 21 Charlotte
 Connor Frank, bar tender, 84 West Main,
 Connor Hugh, roofer, house 167 Alexander
 Connor James, cigar maker, 3 Eagle, b. 101 Mill [h. Penn n. Saxe
 Connor John, lime, rear Court n. Exchange,
 Connor John, conductor, h. 148 North av.
 Connor John, tailor, house 68 Cypress
 Connor John F. compositor, 82 West Main, house 32 Warner [Cypress
 Connor John J. leather finisher, boards 68
 Connor Joseph J. gas fitter, 25 Exchange, b. 165 Alexander
 Connor J. Ellen, nurse, boards 10 Smith
 Connor Mary, domestic, b. 167 Alexander
 Connor Matilda, widow, house 10 Smith
 Connor Thomas, plumber, 96 E. Main, bds. 165 Alexander
 Connor Thomas, moulder, 10 S. Water, h. 11 Galusha [ers' bldgs. h. 40 Prospect
 Connor Timothy, laborer, engine room, Pow-
 Connor William, tinsmith, h. 163 Alexander
 Connor William, clerk, 37 State, boards 191 Exchange
 Connors Daniel, removed from city
 Connors Dennis, laborer, Lyell corner West, house 3 Saxton

Connors Ellen, widow, boards 5 Pine
 Connors James, laborer, boards 3 Saxton
 Connors James, shoemaker, house 1 Ward
 Connors Joanna, widow, house rear 28 Stone
 Connors John, laborer, boards rear 28 Stone
 Connors Joseph, laborer, house 156 Scio
 Connors Julia, widow, h. r. 11 Caledonia av.
 Connors Lawrence, laborer, house Flint near Frances
 Connors Mary, domestic, b. 124 Alexander
 Connors Michael, teamster, Ely Mills, house 121 Childs
 Connors Nellie, domestic, Osburn House
 Connors, see Connor and O'Connor
 Conole Thomas, flagman, house 58 Bolivar
 Conolly Charles J. compositor, 62 E. Main, boards at Gates
 Conover Peter, laborer, bds. 78 S. St. Paul
 Conrad Julius, candlemaker, house 120 Scio
 Conrad Nicholas, boys' clothing, 5 Front, h. 102 University avenue
 Conrad Philip, house 38 Grand
 Conrad Sarah, A. widow, bds. Lewis n. Meigs
 Conrad, see Konrad
 Conroy Margaret, widow, house 22 Smith
 Conroy Patrick C. bookkeeper, 8 State, bds. 22 Smith
 Consadine Catharine, widow, h. 20 Emmett
 Consadine Mary A. Miss, boards 20 Emmett
 Consadine William, machinist, b. 20 Emmett
 Consler Joseph, grocer, 81 Caledonia avenue, house do.
 Consler Thomas, house 95 Adams
 Contant Frederick A. painter, h. 5 Linden
 Contant Jane, widow, house 191 Alexander
 Contant Mary, widow, boards 43 Charlotte
 Convent of Sacred Heart, 2 Prince
 Converse Charles T. (*Rogers & Converse*), 14 Exchange, boards 24 Park av.
 Conway Bridget, widow, h. Flint. n. Frances
 Conway Daniel, cooper, h. 15 Vincent place
 Conway Edward C. carpenter, b. r. 14 Gardiner park
 Conway Edward J. cooper, house 16 Cliff
 Conway Eliza, widow, house Thompson near Jones avenue [b. 42 Lake av.
 Conway Frederick, shipping clerk, 8 White,
 Conway Henry, real estate, house 35 Lyell
 Conway James, engineer, at gas works, h. 15 Ontario
 Conway John, grocer, 314 State, b. 35 Lyell
 Conway Margaret, widow, h. r. 14 Gardiner park [place
 Conway Rosa R. dressmaker, b. 15 Vincent
 Conway Sara A. dressmaker, b. 15 Vincent place
 Conway Thomas, laborer, b. Flint n. Frances
 Conway Veronica Miss, boxmaker, b. Flint near Frances [35 Lyell
 Conway William J. clerk, 314 State, boards
 Coogan Andrew B. planer, lower falls, bds. Fulton avenue cor. Perkins
 Coogan Celia, grocer, 17 Hand, house do.
 Coogan Dennis, laborer, h. 83 Fulton av.
 Coogan James, laborer, boards 83 Fulton av.
 Coogan John, chairmaker, Hastings n. River, boards 83 Fulton av. [house 16 Joiner
 Cooil Richard, blacksmith, Brown c. Jones,

- Cook Abel H. pulpmaker, N. St. Paul, middle falls, house 17 Fulton avenue
 Cook Alexander, carpenter, h. 16 South av.
 Cook Amanda A. dressmaker, b. 73 S. Union
 Cook Andrew A. waiter, boards 91 Wilder
 Cook Anthony G. machinist, Brown corner Jones, house 151 St. Joseph
 Cook A. Harley, pulpmaker, h. 17 Fulton av.
 Cook Catharine, widow, bds. 63½ Gregory
 Cook Catharine, widow, boards 14 Delevan
 Cook Charles, farmer, h. Hague near R. R.
 Cook Charles H. horse trainer, bds. 17 Fulton avenue [h. 21 Sheridan park
 Cook Charles S. (*Southall & Cook*), 116 Front,
 Cook Daniel, shoemaker, boards 66 Martin
 Cook Edward, machinist, Leighton Bridge and Iron Works, h. Fourth avenue near Central park
 Cook Elinor, widow, boards 48 Edinburgh
COOK ELISHA H. & CO. steam heating and ventilating, 11 Exchange, h. at Elmira.—See page 617
 Cook Elizabeth P. house 22 N. St. Paul
 Cook Emily, dressmaker, 50 Saxton, b. do.
 Cook Franklin C. & Co. (*E. H. Geiger*), lumber, 311 State, h. 21 N. Washington
 Cook Frederick, boards 138 North avenue
 Cook Frederick, prest. Roch. German Ins. Co. W. Main c. Fitzhugh, h. 40 Sophia
 Cook George, hostler, 83 Front, bds. 159 St. Joseph [do.
 Cook George, laborer, 181 St. Joseph, h. 151
 Cook George J. jr. confectionery, 56 Allen, house do. [34 N. Fitzhugh
 Cook Geo. S. carpenter, 100 S. St. Paul, bds.
 Cook Henrietta Mrs. boarding house, 37 N. St. Paul, house do.
 Cook Henry, boards 28 Elm [48 Edinburgh
 Cook James, bookkeeper, 65 Exchange, h.
 Cook James M. principal, Tremont school No. 3, house 54 Atkinson [66 Martin
 Cook Jennie, compositor, 23 W. Main, bds.
 Cook John, laborer, house 90 Front
 Cook John, carpenter, Minerva alley, house Park avenue near Goodman
 Cook John, dentist, bds. 91 Wilder [Tappan
 Cook John C. clerk, 15 Exchange, boards 36
 Cook John O. engineer, h. 48 N. Frances
 Cook John T. stoves, 263 State, house do.
 Cook John Y. peddler, h. 12 Oakland park
 Cook Joseph G. engineer, b. 48 N. Frances
 Cook Julia H. Miss, boards 17 Fulton av.
 Cook Julia P. widow, boards 58 Griffith
 Cook Julia P. Miss, boards 16 Mortimer
 Cook Levi, tinsmith, 36 Tappan, house do.
 Cook Louis C. carpenter, house 54 Delevan
 Cook Lucretia, milliner, boards 56 Chestnut
 Cook Peter, farmer, Hospital, West av. cor. Genesee, boards do.
 Cook Peter, carpenter, boards 36 Tappan
 Cook Preston W. boards 22 N. St. Paul
 Cook Reuben, liquors, 34 Marshall, h. do.
 Cook Samuel, boards 13 John
 Cook Samuel, gardener, house 28 Bloss
 Cook Sarah, widow, house 6 Reynolds
 Cook Thomas, musician, boards 20 Canal
 Cook Thomas, gardener, house 166 West av.
 Cook William, driver, Clinton Hotel, b. do.
 Cook William H. painter, 165 E. Main, h. 35 Rauber [No. 5, house 6 Reynolds
 Cook W. Edgar, principal, Central School
 Cook, see Koch
 Cooke Alexander B. printer, 16 W. Main, h. 159 Jones
 Cooke Cyrus T. lumber, North avenue cor. Franklin, boards 5 Chatham
 Cooke George W. salesman, 91 N. Water, h. at Horseheads
 Cooke James M. laborer, 55 Front, h. Kirk
 Cooke Martin W. (*Harris & Cooke*), W. Main cor. Fitzhugh, h. 314 E. Main
 Cooksley James, carpenter, Franklin corner North, boards 20 South Union
 Cooksley Thomas, carpenter, h. 20 S. Union
 Cooksley Wm. T. carpenter, Franklin cor. North, boards 20 South Union
 Cool Henry C. engineer, N. Y. C. R. R. bds. Sprague's Hotel [Avoca
 Coolbaugh W. B. salesman, 39 State, h. at
 Cooley Andrew, removed to Detroit, Mich.
 Cooley Henry J. salesman, 143 State, house Frank cor. Lorimer
COOLEDGE BROTHERS (*C. M. and J. E. Coolidge*), druggists, 124 East Main.—See page 568
 Coolidge Cassius M. artist, 1 Washington Hall blk. and (*Coolidge Bros.*), b. 84 East avenue
 Coolidge John E. (*Coolidge Bros.*), bds. 84 East avenue [Brisbane
 Cooligan John, laborer, paper mills, house 10
 Cooling Edward E. engraver, 62 State, bds. 20 Hunter
 Cooling Ruth, widow, house 20 Hunter
 Coombs John C. ticket agent, 88 Mill, bds. 18 North avenue
 Coombs, see Combs
 Coons Charles S. removed from city
 Coon C. J. Mrs. boards 47 Pearl
 Coon George J. moulder, 8 Hill, house 63 Campbell [ester, h. 81 Court
 Coon Geo. W. student, University of Rochester
 Coon Joseph, cigarmaker, boards 158 Jay
 Coon Mary A. boards 98 Pearl
 Coon Samuel A. engineer, 87 Exchange, h. 21 South avenue
 Coon Sarah Mrs. bds. 11 Centre park
 Coon Wm. carpenter, h. 14 Mark n. Hudson
 Coon, see Coons and Kuhn
 Coonan Bridget, cook, 83 E. Main, bds. do.
 Cooney Daniel E. (*Cutting & Cooney*), 5 North av. house 16 Manhattan
 Cooney Elizabeth Mrs. boards 73 Court
 Cooney Henry, saloon, Goodman c. railroad, house do.
 Cooney John H. tinsmith, bds. 14 George
 Cooney Mary, widow, house 14 George
 Cooney Michael, laborer, boards 92 Davis
COOONEY WILLIAM, brush manufacturer, foot Aqueduct, b. 25 Jones avenue.—See page 669
 Coons Jacob, turner, house 8 Park avenue
 Coons John A. teamster, Crescent Mills, h. 55 Jay
 Coons, see Coon and Kunz
 Coop John, file cutter, 107 Mill, b. 176 State

Cooper Albert G. deceased October 1875
 Cooper Anna D. paster, boards 4 Saxton
 Cooper Caspar, hairdresser, 59 Jay, h. 77 do.
 Cooper Charles D. machinist, h. 31 Jones av.
 Cooper Daniel M. removed to Syracuse
 Cooper David, boatman, house 4 Saxton
 Cooper David H. machinist, b. 31 Jones av.
 Cooper Frank B. machinist, b. 76 Mt. Hope
 avenue
 Cooper Franklin C. house 169 Brown
 Cooper George G. house 55 Frank [Magne
 Cooper Hannah Mrs. housekeeper, Jay cor.
 Cooper Harriet M. widow, house 46 Vienna
 Cooper Henry, coupler, house 24 Channing
 Cooper Hugh, engineer, house 228 North
 Cooper Hugh, cooper, 1 St. James park, h.
 10 Jennings
 Cooper James, laborer, house 9 Campbell
 Cooper James, jr. engineer, 4 Allen, house 7
 Campbell [h. 31 Orchard
 Cooper James, cooper, Magne opp. Walnut,
 Cooper James (J. & J. Cooper), bds. 16 East
 Cooper James D. machinist, b. 7 Campbell
 Cooper James G. house 63 North avenue
 Cooper John, laborer, b. Eighth n. Emerson
 Cooper John, cooper, Magne opp. Walnut,
 boards 31 Orchard
 Cooper John R. sewing machine agent, 20
 E. Main, house 76 Mt. Hope avenue
 Cooper John & J. druggists, 128 East Main,
 house 16 East
 Cooper Joseph, glassblower, b. 93 Reynolds
 Cooper Joseph, house 32 Sherman
 Cooper Julius H. machinist, h. 24½ Bolivar
 Cooper Patrick, bds. 54 East avenue
 Cooper Robert S. removed to Brighton
 Cooper Samuel T. machinist, Mill c. Factory,
 boards 7 Campbell [house do.
 Cooper Sarah M. boarding house, 24 Centre,
 Cooper Simeon O. carpenter, house 72 Pearl
 Cooper Willis N. shoe cutter, bds. 76 Mt.
 Hope avenue
 Cooper Wm. laborer, h. Eighth n. Emerson
 Cooper Wm. engineer, N. Y. C. R. R. house
 14 Campbell
 Cooper William jr. removed to Clinton
 Co-operative Foundry Company, 8 Hill
 Cooté Maria, widow, house 134 North
 Coots Charles, architect, 104 Powers' bldgs.
 house 77 Lake avenue [42 Savannah
 Copeland Charles D. salesman, 62 State, h.
 Copeland David, boards 45 Lancaster
COPELAND DAVID jr. drain and sewer
 pipe, 90 South St. Paul, house 83 Court.
 —See page 658
 Copeland George E. (Fullam & Copeland), 14
 Smith's blk. h. Genesee n. Flint
 Copeland John A. removed to Warsaw
 Copeland J. Clark, bookkeeper, 90 South St.
 Paul, boards 56 East avenue
 Copeland Maria T. widow, h. 35 Chestnut
 Copeland Sarah T. Mrs. teacher, Wadsworth
 school, No. 12, bds. 56 Chestnut
 Copeland William E. mason, house 81 Court
 Copenhagen John, mason, house 49 Caroline
 Copenhagen Theodore, stonecutter, 8 West
 avenue, house Alphonse n. Edward
 Copithorn Eliza, widow, h. 57 Litchfield

Coplin Jacob H. printer, 82 W. Main, h. 31
 S. Washington
 Copp George, driver, 60 State, h. 47 Delevan
 Copp John, file cutter, boards 167 State
 Copp Monroe M. carriage maker, h. 11 Ham-
 ilton place
 Copp Philip C. mason, boards 167 State
 Coppejohn James P. machinist, house 90
 Exchange
 Coppejohn, see Koppyan
 Corbett Mary, widow, boards 94 North av.
 Corbett Fannie, seamstress, b. 94 North av.
 Corbett John, stonecutter, 22 West av. bds. 9
 Caledonia av.
 Corbett Mary, widow, h. Richards n. Wilcox
 Corbett Patrick, deceased June, 1875
 Corbett Patrick W. florist, Monroe av. near
 Boardman, bds. Richards n. Wilcox
 Corbett Thomas, laborer, h. Sibley n. Bates
 Corbett Wm. laborer, bds. 33 Frank
 Corbin George W. carpenter, bds. Genesee n.
 Flint [Flint
 Corbin Joseph, collector, h. Genesee near
 Corbin Pamela, widow, bds. 18 Gorham
 Corbin Philetus H. sash locks, h. 24 Marshall
 Corbitt John, laborer, house 82 Weld
 Corbusier Frank H. (Corbusier & Nagle), 54
 South avenue, house do.
 Corbusier & Nagle (F. H. Corbusier & J. A.
 Nagle), grocers, 54 South av.
 Corcoran Betsey, widow, h. Montgomery al.
 cor. N. Y. C. R. R.
 Corcoran Catharine, shoe fitter, b. 14 Magne
 Corcoran Catharine, widow, h. 14 Magne
 Corcoran James, boilermaker, h. 54 Saratoga
 avenue [Main, b. 30 Cady
 Corcoran Jeremiah, stovemounter, 187 West
 Corcoran Jeremiah, laborer, h. 14 Erie
 Corcoran Johanna, deceased March, 1876
 Corcoran John, thermometer maker, 3 Hill
 boards 30 Cady
 Corcoran John, peddler, house 13 Cady
 Corcoran John, laborer, h. Lake av. c. Lyell
 Corcoran Margaret, sewer, bds. 14 Magne
 Corcoran Mary, widow, bds. 14 Erie
 Corcoran Richard, boilermaker, h. Leighton
 av. n. Crouch
 Corcoran Rosanna M. widow, h. 27 Smith
 Corcoran Timothy, currier, 87 N. Water, b.
 Centre cor. Mill [Cady
 Corcoran Timothy, laborer, h. Seward n.
 Corcoran Timothy, laborer, 17 Warehouse,
 h. Seward n. Champlain
 Corcoran William, blacksmith, h. Brown's
 al. n. Lyell
 Cordwell Ann, widow, boards 9 Meigs
 Corey Henry A. bakery, 79 North av. h. do.
 Corey, see Cory [Grove
 Cork Alfred H. grocer, 151 E. Main, h. 10
 Corker John, grinder, bds. 50 Allen
 Corker Samuel, sawmaker, bds. 50 Allen
 Corkhill Henry R. machinist, 1 Aqueduct
 cor. race, house 17 Jones avenue
 Corkhill John, watchman, Rochester Opera
 house, house 83 Atwater
 Corkhill Mary J. dressmaker, bds. 17 Jones
 avenue
 Corkhill Thomas, tanner, house 20 Andrews

Corkhill William, machinist, Court corner Stone, h. 87 Atwater
 Corl Ellen, widow, bds. 74 Atkinson
 Corlett Anna J. teacher, boards 11 George
 Corlett Eliza, dry goods, Court cor. Chestnut, h. 11 George [h. 122 Adams
 Corlett Frederick, teamster, 57 Fitzhugh,
 Corlett Henry, stair builder, r. 11 George, h. 9 Concord avenue
 Corlett John, stair builder, 11 George, b. do.
 Corlett Matthew R. stair builder, 11 George, house do. [h. 13 Romeyn
 Cormack Francis, engineer, N. Y. C. R. R.
 Cormode Catharine, widow, b. 25 Campbell
 Cormode Charles, boat builder, h. 46 Childs
 Cormode Daniel, boat builder, boards 25 Campbell
 Cormode Thomas, boat builder, b. 25 Campbell
 Cornelia Sister, teacher, bds. Jay cor. Frank
 Cornelius Abram, sashmaker, ft. N. Water, h. 35 Asylum
 Cornelius Mary, widow, house 35 Rhine
 Cornell Charles, removed to Lyons
 Cornell James, miller, N. Water foot Mortimer, house 325 State
 Cornell Joseph D. farmer, h. 223 Exchange
 Cornell Nellie F. teacher, Concord school No. 18, bds. 6 Edward
 Cornell Stephen, carpenter, house 6 Edward
 Cornell Winslow J. file forger, River near N. Water, h. 20 West Maple [Clinton
 Cornforth Eliza, music teacher, house 199 N.
 Cornforth John, removed from city
 Corning Edward, bookkeeper, 109 W. Main boards 26 N. St. Paul
 Corning John, stone cutter, b. 30 Mumford
 Corning J. Sherwood, bookkeeper, 109 W. Main, boards 26 North St. Paul
 Corning T. B. & W. bankers, 109 W. Main,
 Corning William, (T. B. & W. Corning), h. 26 N. St. Paul [bds. 26 N. St. Paul
 Corning William jr. teller, 109 West Main,
 Cornish Clemence C. agent, 55 S. St. Paul, h. at Fairport [Alexander
 Cornwall Amelia Mrs. seamstress, bds. 204
 Cornwall Clara, widow, b. 47 Jones av.
 Cornwall Elizabeth, widow, h. 13 East av.
 Cornwall John, house 12 Chestnut
 Cornwall Richard F. bds. 10 Chestnut pk.
 Cornwell George L. house 14 Reynolds
 Cornwell Samuel D. deceased June, 1875
 Corridor Nettie D. Mrs. b. 46 Tappan
 Corrigan Alice, sewing, boards 45 William
 Corrigan James, laborer, house 3 James
 Corrigan Maggie, sewer, boards 45 William
 Corrigan Margaret, widow, h. 45 William
 Corrigan Maria Mrs. boards 7 Davis
 Corrigan Mary, widow, bds. 76 South avenue
 Corrigan Mary, widow, house 247 State
 Corrigan O'Brien, laborer, h. 17 Lyell
 Corrigan Patrick, mason, house 100 Bartlett
 Corrigan Philip H. saloon, 135 West Main, house do.
 Corrigan Thomas, laborer, bds. 247 State
 Corrigan William C. boilermaker, Platt n. Jones, house 276 State [Charlotte
 Corris John F. salesman, 80 State, house 29

Corris William R. grocer, 222 E. Main, h. 29 Gibbs
 Corris William W. clerk, Hill c. Elizabeth, bds. 29 Charlotte
CORRIS WILLIAM & CO. (S. B. Roby), carriage bent wood work and wheel manuf. Hill c. Elizabeth, h. 29 Charlotte. —See page 607
 Corson Benjamin F. bookkeeper, 134 East Main, house 85 Broadway
 Corson Martin, shoemaker, 91 N. Water, b. 56 Front [bds. do.
 Cortright Byron W. blacksmith, 14 Market,
 Cory David (Alling & Cory), 12 Exchange, h. 5 Tremont [Tremont
 Cory Eliakim T. clerk, 10 Exchange, h. 4
 Cory Elizabeth A. widow, b. r. 46 South av.
 Cory Jessie, widow, h. Frank near Lorimer
 Cosgrove Eliza Miss, b. Champlain n. Summer [avenue
 Cosgrove John, laborer, house 39 Fulton
 Cosgrove Michael, engineer, N. Y. C. R. R. bds. Brackett House
 Cosgrove Patrick, laborer, h. 37 Brown's blk.
 Cosgrove Thomas, b. Champlain n. Summer
 Cosgrove Thomas, switchman, h. Myrtle near Lyell
 Coslow George, boards 77 Front
 Cost Henry, house 30 North avenue
 Costain Henry, millwright, 127 Mill, house 21 Rhine
 Costello Ann, boards 38 Munger
 Costello Anna M. vestmaker, bds. 42 Munger
 Costello Bernard, cooper, Brown's alley, h. 21 Lyell [McCracken
 Costello Edward C. hostler, b. Straub alley n.
 Costello Francis C. removed to Williamstown
 Costello Henry W. blacksmith, Carthage al. near River, h. 237 North
 Costello Honora, widow, boards 5½ Munger
 Costello James, laborer, house 42 Munger
 Costello James E. machinist, bds. 2 Garden
 Costello James M. brushmaker, ft. Aqueduct, house Flint near Reynolds
 Costello Jane, widow, house 2 Garden
 Costello John, laborer, h. 23 Oakland park
 Costello John, house 63 University avenue
 Costello John J. clerk, 1 Front, b. 21 Lyell
 Costello Julia, widow, h. Flint n. Reynolds
 Costello Michael, shoemaker, h. Gold n. Mt. Hope ave.
 Costello Michael, filemaker, bds. 42 Munger
 Costello Thomas, nurseryman at Elwanger & Barry's, house 51 Cypress
 Costello Thomas, waiter, boards 21 Lyell
 Costello Thomas S. grocer, 196 Exchange, bds. do.
 Cotchefer Elizabeth N. widow, h. 93 N. Union
 Cotchefer Francis, gardener, bds. 116 Plymouth av. [h. 6 Tremont
 Cotchefer Richard, grocer, 94 Plymouth av.
 Coté Joseph, shoemaker, 40 Front, house do.
 Coté Peter jr. shoemaker, 111 State, house 40 Martin [Clinton
 Cotter Dennis, laborer, 187 W. Main b. 127 N.
 Cotter John, laborer, house 53 Munger
 Cotter John, teamster, h. Field n. Monroe av.
 Cotter Mary, widow, b. 127 N. Clinton

HENRY C. WISNER,

MAJOLICA, KIWOTA AND JAPANESE CHINA,
 No. 33 STATE STREET.

Cotter Mary Miss, shoe finisher, b. 42 Strong
 Cotter Michael H. laborer, State c. Centre h. 63 Troup [Fitzhugh
 Cottrell Frank W. (*Cottrell & Stevenson*), h. 61
 Cottrell William, boot treer, 55 Mill, h. 15 Dover
COTTRELL & STEVENSON (*F. W. Cottrell and M. Z. Stevenson*), grocers, 13 Spring.—*See page 555*
 Couch Rhoda S. widow, bds. 13 Caledonia avenue
 Couch Walter V., Rev. dist. sec. Am. Tract Society, 75 State, house 13 Caledonia av.
 Coughlin Catharine, widow, house Anderson avenue c. Fairmount [Dean
 Coughlin James J. coppersmith, boards 11
 Coughlin John, trunkmaker, ft. Rowe, house 1 Second near Rowe
 Coughlin John, teamster, boards 29 Gibbs
 Coughlin John, teamster, 17 Warehouse, h. 83 Childs [No. 17, bds. 11 Dean
 Coughlin Mary L. teacher, Whitney School,
 Coughlin Sarah L. teacher, Whitney School, No. 17, boards 11 Dean
 Coughlin William, laborer, house 11 Dean
 Coughlin William, nurserymen, boards Anderson avenue c. Fairmount
 Coughlin William F. machinist, b. 11 Dean
 Coulson George R. clerk, bds. 92½ East av.
 Coulson Henrietta, widow, h. 92½ East av.
 Coulson Thomas P. harnessmaker, boards 92½ East avenue
 Counsel John, carpenter, 100 South St. Paul, house 38 South [h. 282 State
 Countryman Alfred, confectioner, 9 Arcade,
 Courlett Fred. teamster, house 59 Reynolds
 Courneen Annie E. dressmaker, 33 Lancaster, house do. [St. Paul, h. 3 Marshall
 Courneen James K. (*J. Hayes & Co.*), 22 S.
 Courneen Roger, tobacco worker, 55 S. St. Paul, house 39½ Munger
 Coursen Albert P. baggageman, N. Y. C. R. R. depot, boards 1 Harrison
 Coursen Isaac D. conductor, N. Y. C. R. R. house 48 Nassau [Champlain
 Coursen Lyman G. baggageman, house 127
 Coursen Mary H. widow, house 1 Harrison
 Coursen Newton, shoe cutter, 124 Front, bds. 1 Harrison [h. 234 do.
 Courtney James (*Courtney & Henry*), 341 State,
 Courtney Martha, dressmaker, 52 Howell, house do. [Waverley place
 Courtney Robert, cigarmaker, 341 State, b. 8
 Courtney Thomas, miller, h. 8 Waverley pl.
 Courtney Thomas jr. cigarmaker, boards 8 Waverley place
COURTNEY & HENRY (*J. Courtney and J. Henry*), cigar manufacturers, 341 State.—*See page 565* [h. 17 Troup
 Cousandier Edward, cabinetmaker, 184 State,
 Covell Charles (*J. Marden & Co.*), 85 Front, house at Brighton
 Covell Milton W. student, University of Rochester, boards 6 Charlotte
 Coventry Fred. clerk, 53 East Main, bds. 31 Fitzhugh
 Coventry Maria J. widow, house 31 Fitzhugh
 Covert Annie, domestic, 118 Oak

Covert Isaac, carpenter, house 8 Channing
 Covey Dioclecion, agent, 8 Sibley's block, h. 72 Asylum
 Covney Anna, saloon, 71 Front, house do.
 Covney Edwin, clerk, 71 Front, house do.
 Cowan Charles, shoemaker, 111 State, boards 113½ East Main [seph, h. do.
 Cowan Leonard, confectionery, 116 St. Jo-
 Cowd Joseph M. carpenter, h. 246 Exchange
 Cowder Jacob, laborer, house rear 22 Stillson
 Cowdery Sarah, widow, house 20 Andrews
 Cowell H. Lucetta, widow, house 88 Tappan
 Cowen William W. (*Hazeltine, Cowen & Co.*), 14 Exchange, boards 25½ East avenue
 Cowles Charles, clerk, boards 10 Martin
 Cowles, Curtis & Co. (*J. Cowles, E. T. Curtis and A. H. Wheeler*), boot and shoe manufacturers, 15 Mill
 Cowles Edward J. machinist, b. 83 Atwater
 Cowles Elon H. salesman, 111 State, boards 103 Frank
 Cowles Emma Mrs. teacher, house 123 Scio
 Cowles E. Frances, teacher, Concord School, No. 18, boards 63 Delevan [Scio
 Cowles E. Wanzer (*Cowles & Harris*), h. 123
 Cowles Jessie Miss, teacher, Tremont School, No. 3, boards 116 Fulton avenue
 Cowles John (*Cowles, Curtis & Co.*), 15 boards 139 Lake avenue [Martin
 Cowles John C. moulder, Platt n. Jones, h. 10
COWLES JOSEPH, millwright, 127 Mill, house 116 Fulton av. near Perkins.—*See page 676*
 Cowles Norman, chairmaker, h. 63 Delevan
 Cowles Wm. H. machinist, Court cor. Stone, house 16 Alexander
 Cowles & Harris (*E. W. Cowles and C. H. Harris*), shoe manufs. 8 N. Water
 Cowley Abram, fireman, Erie Railway, bds. 20 Edingburgh [State, house do.
 Cowley Covil R. cider press manuf. 110
 Cowley Edward A. druggist, 236 Brown opp. Allen, house do.
 Cowley —, widow, house 84 Monroe av.
 Cowman George H. (*Cowman & Flynn*), house 19 Emerson
 Cowman John, removed to Detroit
 Cowman & Flynn (*G. H. Cowman and J. Flynn*), carpenters, 19 Emerson
 Cowy Wm. farmer, house Waring road near Norton [Union
 Cox Alexander H. physician, bds. 34 North
 Cox Alfred F. carpenter, house 95 Broadway
 Cox Barzilla R. agent, boards 10 Gorham
 Cox Edward M. shoemaker, h. 19 Reynolds
 Cox Edward M. jr. shoemaker, 87 N. Water, boards 2 Bolivar
 Cox Eliza T. bookkeeper, bds. 14 Pleasant
 Cox Francelia Miss, boards 3 North Union
 Cox George W. salesman, 17 Front, boards Genesee near Strong [41 Frank
 Cox Henry M. physician, 318 State, boards
 Cox James, shoemaker, 83 N. Water, boards 45 Frank
 Cox James, laborer, house Pine near Spring
 Cox John, removed from city
 Cox Joseph T. jr. (*Joseph T. Cox & Son*), house Conkey avenue cor. avenue A

- Cox Joseph T. & Son (*J. T. Cox, jr.*), planing mill, N. Water n. railroad, h. 10 Gorham
- Cox Julia Miss, forewoman, b. 14 Pleasant
- Cox Mary, widow, house 14 Pleasant
- Cox Michael, deceased May 8, 1876
- Cox Patrick (*Cox & Brady*), 83 North Water, house 45 Frank [George
- Cox Wm. H. miller, Ely Mills, boards 10
- COX WILLIAM**, merchant tailor, 17 and 19 Front, house Genesee corner Strong. — See page 538
- Cox & Brady (*P. Cox and C. A. Brady*), boot and shoe manufs. 83 North Water
- Coxon George, junk store, 90 Front, h. do.
- Coxon Robert, painter, boards 90 Front
- Coy Delia, dressmaker, boards 8 Rome
- Coye Hannah, widow, boards 59 Kirk
- Coykendall Ford, clerk, 147 State, boards 146½ West Main
- Coyle Ann, cleaner, house 22 Andrews
- Coyle John, bill poster, 8 Corinthian Hall building, boards 22 Andrews
- Coyle Margaret, domestic, 107 Lake avenue
- Coyle Mary E. Mrs. copyist, b. 15 Pleasant
- Coyle Patrick, boiler maker, house 165 Alexander [22 Cole
- Coyle Patrick, shoemaker, 111½ State, house
- Coyne James E. laborer, bds. 112 Lake av.
- Coyne Thomas, laborer, West corner Lyell, house 112 Lake avenue
- Cozzens Ellen Mrs. boards 37 Troup
- Crabb Rebecca, widow, boards 250 State
- Crabbe Augusta, widow, boards Gibbs cor. Grove [Mt. Hope avenue
- Crabtree George, marble worker, house 127
- Craddock Hannah, widow, h. 155 Exchange
- Craddock Mary A. widow, h. 3 Edinburgh
- Craddock Thomas, painter, 125½ State, house 22 Glasgow [Edinburgh
- Craddock William T. shoemaker, boards 3
- Craft James E. foreman, 42 Exchange, house 47 Cypress
- Craft, see Kraft
- Craib James, seed grower, house Culver near Webster road [Alexander
- Craig Henry H. (*Craig & Crouchs*), house 117
- Craig Mary, widow, bds. 126 Mt. Hope av.
- Craig Oscar, lawyer, 58 Powers' buildings, boards 5 South Washington
- Craig Peter, white washer, h. 2 Plum alley
- Craig Rodie, widow, bds. East av. c. Prince
- Craig Wm. R. (*D. W. Wright & Co.*), 73 N. Water, boards 25 Kent
- CRAIG & CROUCHS** (*H. H. Craig, G. W. and C. T. Crouch*), lumber, 4 Griffith. — See page 637
- Craig see Krieg and Krieg
- Craige Henry, blacksmith, Exchange opp. Glasgow, b. 4 Edinburgh
- Craighead John, shoemaker, h. 156 Fitzhugh
- CRAIGHEAD JOHN Jr.** music store, 109 E. Main, boards 156 Fitzhugh. — See page 525 [office, h. 108 Plymouth av.
- Craigie Frank J. cashier, Erie Ry. freight
- Craigie Frederic E. printer, 1 Aqueduct, boards 108 Plymouth avenue
- Craigie John, clerk, boards 62 Exchange
- Cram Ambrose, house 75 Allen
- Cram Henry, cigarmaker, house Channing near North
- Cram John F. carpenter, house 68 Troup
- Cramer Bridget, widow, house 191 N. Clinton
- Cramer Charles, teamster, house Monroe av. near toll gate
- Cramer Diana, widow, house 36 Broadway
- CRAMER J. GEORGE**, bag warehouse, 25 W. Main, house 7 Grove. — See page 678
- Cramer Mary, whipmaker, boards 23 Jay
- Cramer, see Kramer and Kraemer [Mich.
- Cramond George T. removed to Lansing,
- Cramond John, paver, boards 236 E. Main
- Cramond Robert W. removed to Lansing, Michigan
- Crampton Frederick W. clerk, boards 12 N. Washington [bridge's blk. h. 159 Wilder
- Crampton John H. shoemaker, 27 Wal-
- Crandall Charles F. draughtsman, 102 Powers' bldgs. boards 74 Lake avenue
- Carndall Chester D. student, University of Rochester, boards 16 Canal
- Crandall Eber, carpenter, house 12 Adams
- Crandall Frank M. farmer, house Genesee near Cottage
- Crandall Henry, house 7 Rowley
- Crandall Jennie, teacher, Chestnut School, No. 11, boards 7 Rowley
- Crandall John D. clerk, N. Y. C. R. R. office 151 State, boards 170½ West Main
- Crandall Mary Mrs. house 4 South Ford
- Crandall Philander M. lawyer, 40 Arcade, house 74 Lake avenue [h. do.
- Crandall Sarah Mrs. dressmaker, 12 Adams,
- Crandall Walter E. boots and shoes, 108 Plymouth av. house 11 Adams [Main
- Crandall William, carpenter, house 102½ E.
- Crandel Frank, laborer, boards Thompson avenue near Leighton avenue
- Crane Alonzo G. painter, h. 42 Glenwood av.
- Crane Ann L. widow, boards 29 Elizabeth
- Crane Charity W. widow, h. Fulton av. corner Bloss
- Crane Dan'l G. machinist, 129 Mill, h. 22 Vose
- Crane Edmund M. actor, house 61 Troup
- Crane Edward, cutter, 24 State, h. 3 Rome
- Crane Edward jr. gas fitter, 25 Exchange, boards 3 Rome [cor. Bloss
- Crane Elias W. carpenter, b. 131 Fulton av.
- Crane Ernest U. H. laborer, bds. 274 State
- Crane Frank A. carpenter, house 24 Bloss
- Crane George W. collarmaker, 129 State, h. 60 Munger
- Crane Gilbert, h. Goodman c. University av.
- Crane John, trimmer, boards 57 Prospect
- Crane John C. carpenter, h. 5 Clinton place
- Crane Joseph A. carpenter, 16 Weld, b. do.
- Crane Joseph M. wigmaker, 9 Eagle, h. do.
- Crane Nettie, house 100 State
- Crane Samuel G. planemaker, h. 318 State
- Crane Thomas, carpenter, 16 Weld, h. do.
- Crane William E. carpenter, b. Fulton av. cor. Bloss [green pk. n. Evergreen
- Craner Amelia E. Mrs. midwife, h. Ever-
- Cranston Robert, peddler, 144 East Main, h. 2 Glasgow
- Cranwell Mary A. domestic, 77 Frank
- Craven Jane (*Craven Sisters*), 49 State, b. do.

HENRY C. WISNER,

COCKSON & CHETWYND'S WHITE GRANITE WARE, No. 33 STATE STREET.

- Craven Mary (*Craven Sisters*), 49 State, b. do.
 Craven Sisters (*J. and M. Craven*), patterns, 49 State [Ont.]
 Crawford Clarence L. removed to Hamilton,
 Crawford Duncan, boards 115½ E. Main
 Crawford James, laborer, house 33 Jones
 Crawford Jethro B. watchmaker, 53 West Main, boards 171½ East Main
 Crawford John, teamster, b. Wimple House
 Crawford John, cooper, 30 Canal, house 415 Brown [house do.]
 Crawford Martha, milliner, 115½ E. Main,
 Crawley George, collector, 82 West Main, house 26 Scio
 Crawley Homon, printer, 23 West Main, boards 222½ E. Main [Clinton pl.]
 Crawley Margaret, dressmaker, house 50
 Crawn A. Courtlan, carriage painter, 194½ West Main, house 81 Frances
 Cray Maria L. Miss, house 25 Palmer's block
 Cray Mary, bluing maker, b. 40 Lancaster
 Cray Mary, widow, house 40 Lancaster
 Crayton Margaret, shoe trimmer, b. 59 Bolivar
 Crayton Martin, laborer, Brown cor. Jones, house 59 Bolivar
 Crebbin John, removed to Michigan
 Credit Peter, planer, h. rear 70 N. St. Paul
 Creed William (*Creed & Avery*), h. 59 Gregory
 Creed William H. bookbinder, boards 59 Gregory
(CREED & AVERY (*W. Creed and F. W. Avery*), bookbinders and blank book manufs. 29 West Main.—See page 520
 Creegan Hugh, foreman, h. 36 Brown's al.
 Creegan John, contractor, house 152 Frank
 Creegan John, gasfitter, 8 Mumford, b. Frank
 Creegan Mary A. stitcher, bds. 152 Frank
 Creehan Kate, seamstress, bds. 11 Oregon
 Creelman John, cartman, house 15 Ambrose
 Creelman John jr. gasfitter, 25 Exchange, b. 15 Ambrose
 Creelman Matthew, cartman, house 16 Cliff
 Creelman Matthew T. teamster, b. 16 Cliff
 Creelman Peter W. engineer, N. Y. C. R. R. house 37 Hudson [b. 15 Ambrose
 Creelman William J. draughtsman, 138 Mill,
 Crehore Laban S. boards 72 Pearl [34 Kent
 Creighton John G. coppersmith, Platt, house
 Creighton, see Crayton
 Crennell Daniel, carpenter, h. 169 N. Clinton
 Crennell Daniel jr. postal clerk, bds. 169 N. Clinton
 Crennell Robert, upholsterer, b. 169 N. Clinton
 Crennell William H. house 31 Oak
 Crerar Thomas H. confectioner, h. 54 Frank
 Criddle Eliza, widow, h. Harris avenue near avenue A
 Crimmin Catharine, widow, b. 160 North av.
 Crippen Benjamin H. nurseryman, house 35 Munger [ster road
 Crippen Daniel, farmer, h. Culver n. Web-
 Crippen Eliza J. widow, house 83 Scio
 Crippen William H. house 17 Anson park
 Cripps Cristopher, laborer, house Scottsville road at Rapids [17 Murray
 Cripps Frederick, peddler, 144 E. Main, h.
 Crispin Bridget, boards 64 Exchange
 Crispin John, laborer, house 19 Spring
 Crispin William H. saloon, 64 Exchange, house do. [332 State, house do.]
 Crissy George W. proprietor Bantel Hotel,
 Critchell James, carpenter, house 26 Cole
 Critchell James M. (*Stewart, Woodcock & Co.*) 15 W. Main, h. 36 University av.
 Critchley Dora, deceased, 1875 [Charlotte
 Critchley Samuel, box maker, 57 State, h. 38
 Critchley Thomas, laborer, h. 58 Asylum
 Critchley Wm. maltster, house 29½ Munger
 Crittenden Addie Mrs. house 17 Broadway
 Crittenden Claude, music teacher, boards 72 Lake avenue
 Crittenden Cotton M. librarian, law library, Court House, house 72 Lake avenue
 Crittenden DeLancy, lawyer, 15 Powers' buildings, house 72 Lake avenue
 Crittenden Fred B. student, b. 10 Emerson
 Crittenden George S. student, b. 10 Emerson
 Crittenden Julius G. expressman, b. 24 Frank
 Crittenden Nancy J. B. widow, h. 10 Emerson
 Crittenden Pharcellus V. (*H. A. Brewster & Co.*), 6 S. St. Paul, h. 12 Monroe avenue
 Crittenden Sluman C. dentist, house 128 Mt. Hope avenue [Main, h. 59 Savannah
 Crittenden Thompson W. salesman, 68 East
 Crittenden Wellington M. chainmaker, 117 N. Water, house 115 Brown
 Crittenden Wm. B. stenographer, 15 Powers' buildings, boards 72 Lake avenue
 Crittenden Wm. H. deputy collector, Custom House, 31 State, house 258 do. [Elm
 Crobaugh John F. clerk, 18 E. Main, bds. 2
 Crocker Daniel, deceased Dec. 12, 1875
 Crocker Henry, warehouseman, Jefferson Mills, bds. 13 Saratoga avenue
 Crocker Helen, widow, house 79 Tremont
 Crocker John, miller, C. B. Hill's, boards 79 Tremont [house 13 Saratoga av.
 Crocker Nicholas W. miller, Jefferson Mills,
 Crocker Wm. teamster, Jefferson Mills, bds. 13 Saratoga avenue
 Crocker Wm. N. miller, boards 79 Tremont
 Croft Frances, produce, 3 Lowell, boards 6 Gorham
 Croft Henry W. (*Polley & Croft*), 3 N. Clinton and N. Union, n. R. R. h. 51 Asylum
 Croft Ida M. Miss, copyist, bds. 451 Brown
 Croly Del. telegrapher, bds. 124 Atkinson
 Croly Edwin H. clerk, N. Y. C. R. R. freight house, Platt cor. Kent, b. 10 Chestnut
 Croly Michael, cutter, 24 State, house 124 Atkinson [h. 27 Tappan
 Crombach August, tailor, 54 Smith's block,
 Crombach Frank, plumber, 96 East Main, boards 27 Tappan
 Crombach Philip, boards 27 Tappan
 Crombach Philip A. moulder, Brown's race near Furnace, house 29 Tappan
 Crombie Charles, paver, house 32 Brown's al.
 Cromer Charles, shoemaker, h. 99 Champlain
 Cromer Margaret, saloon, 12 Oakman
 Cromer Mary A. widow, house 77 Lyell
 Cromey Stephen, stonecutter, 22 West av. h. rear 74 Atkinson
 Cronise Henry A. student, University of Rochester, boards 80 Court
 Cronise Wm. H. clerk, 73 E. Main, b. 14 Elm

Cronk John, removed to Victor
 Cronk Richard H. foreman, 153 N. Water,
 house 132 Wilder
 Cronk Sarah A. Miss, removed to N. Y. city
 Cronk William, boarding house, 12 North
 Washington
 Crooke Edward, foreman, Mt. Hope Ceme-
 tery, h. Mt. Hope avenue n. Mt. Hope
 Crooke George, gasfitter, bds. 44 Charlotte
 Crooke Maggie, domestic, bds. 44 Charlotte
 Crooks Alexander B. salesman, 307 State, b.
 27 Spencer
 Crooks Jared C. boards 27 Spencer
 Crooks Mary, widow, house 27 Spencer
 Crosby David G. peddler, 144 East Main
 Crosby Frederick H. telegrapher, 151 State,
 boards 58 Frank [28 Gregory
 Crosgrove William, carver, 184 State, house
 Crosier Emeline E. widow, h. 84 Monroe av.
 Crosier Frank H. removed to Clyde
CROSMAN BROS. (*C. W. and G. F.*
Crosman), seedsmen, 300 Monroe avenue
 near tollgate.—*See page 516*
 Crossman Chas. W. (*Crosman Bros.*), boards
 301 Monroe av. near tollgate
 Crossman C. F. Mrs. widow, house Monroe
 av. near tollgate [n. tollgate
 Crossman Daniel T. student, bds. Monroe av.
 Crossman George F. (*Crosman Bros.*), boards
 301 Monroe av. near tollgate
 Cross Brothers (*O. M. and W. H. Cross*), belt-
 ing, 108 Front [N. St. Paul
 Cross Colin W. beltmaker, 108 Front h. 208
 Cross Eliza G. paper maker, bds. Fulton av.
 cor. Champion
 Cross John B. removed to Blood's station
 Cross Margaret, widow, house 105 Fulton av.
 Cross Margaret Mrs. house 28 Centre
 Cross Oliver M. (*Cross Bros.*), h. 4 Centre pk.
 Cross Oliver M. jr. musician, b. 4 Centre pk.
 Cross Susan B. stitcher, bds. 105 Fulton av.
 Cross Wm. H. (*Cross Bros.*), house 4 Frances
 Crossett John, house 21 South
 Crossett Phebe A. widow, house 25 South
 Crossett Wm. M. house 25 South
CROSSMAN BENJAMIN P. photograp-
 her, 120 State, house do.—*See page 522*
 Croston Frank, broom manuf. Court cor. S.
 St. Paul, h. Conkey av. near Clifford
 Croston William, broom maker, S. St. Paul
 cor. Court, house 88 Mt. Hope avenue
 Crouch Charles E. clerk, 347 State, boards
 144 Jones
 Crouch Charles T. (*G. W. and C. T. Crouch*),
 and (*Craig & Crouchs*), h. 101 Alexander
 Crouch Delia E. teacher, Monroe school, No.
 15, boards 101 Alexander
 Crouch Frances, stitcher, bds. 20 North av.
 Crouch Frank P. bookkeeper, S. St. Paul n.
 Griffith, boards 19 Howell
CROUCH GEORGE W. & C. T. lumber
 merchants and steam saw mill, South St.
 Paul n. Griffith, and (*Craig & Crouchs*),
 house 19 Howell.—*See page 637*
 Crouch George W. jr. bookkeeper, 4 Griffith,
 house 1 Union park
 Crouch James, carpenter, 144 Jones, h. do.
 Crouch James H. carpenter, boards 144 Jones

Crouch James J. cabinetmaker, house Penn
 near Sumner [S. St. Paul, h. do.
 Crouch Mary A. Mrs. intelligence office, 147
 Crouch Thomas E. policeman, City Hall, h.
 90 Jay [comb House, bds. do.
 Crouch Wesley (*Whitcomb & Crouch*), Whit-
 Crouchen Louise, dressmaker, bds. 32 Stone
 Crouchen Wm. H. lawyer, h. 114½ Lake av.
 Crough Patrick, baggage checker, N. Y. C.
 depot, house 11 Shamrock
 Crow Anna N. domestic, 49 Jones avenue
 Crowe Bridget, widow, b. N. Union n. railroad
 Crowe James, switchman, boards N. Union
 near railroad
 Crowe Mary, tailoress, b. N. Union n. railroad
 Crowe Mary, widow, bds. 153 North Union
 Crowe Michael, laborer, b. N. Union n. railroad
 Crowell Henry M. clerk, 9 Arcade, h. 85 Scio
 Crowell Lucy, widow, boards 41 Prospect
 Crowell Walter S. grocer, 93 Caledonia av.
 house do. [41 Prospect
 Crowell Wm. H. bookkeeper, 39 State, house
 Crowley Bartholomew, policeman, City Hall,
 house 6 Ward [plain, house do.
 Crowley Dennis, grocer, Seward c. Cham-
 Crowley Jeremiah, nurseryman, h. 18 Seward
 Crowley Mary, widow, house 27 South
 Crowley Wm. G. reporter, boards 27 South
 Crowly Margaret, widow, boards 16 Ontario
 Crowner Matthias, house 6 Meigs
 Crowner Tice, boards 11 Arnold park
 Crowner William, house 11 Arnold park
 Crum Wm. C. Evening Express Printing Co.
 23 W. Main, house 125 Mt. Hope avenue
 Crye William, removed to San Francisco, Cal.
 Cubbage John, nurseryman, bds. 56 Front
 Cuisack Celia, widow, house 1 Moore's alley
 Cuisack Paul, cigarmaker, 147 East Main,
 boards 1 Moore's alley [n. Diem
 Culbery Christina, widow, house 158 Lewis
CULHANE JOHN, wholesaler confectioner
 and fruit dealer, 144 West Main, house
 do.—*See page 560*
 Culhane Margaret, widow, house 53 Troup
 Cull Andrew, cabinetmaker, h. 26 Hanover
 Cull William, removed to Brighton
 Cullen Ann, widow, house 101 Frank
 Cullen Catharine, widow, house 38 Savannah
 Cullen Christopher, laborer, 65 North Water,
 house 8 Thompson [h. Magnolia
 Cullen James 2d, blacksmith, 31 Mumford,
 Cullen James, laborer, house 58 Pinnacle av.
 Cullen James, blacksmith, 31 Mumford, h. do.
 Cullen James F. cutter, 83 N. Water, bds.
 58 Pinnacle avenue
 Cullen John, machinist, Brown's race near
 Furnace, house 72 Hickory
 Cullen John, removed from city [101 Frank
 Cullen John, baggageman, N. Y. C. R. R. b.
 Cullen John K. tailor, 55 E. Main
 Cullen John P. hostler, 15 Fitzhugh, boards
 38 Savannah
 Cullen Joseph, switchman, Jay st. crossing,
 boards 100 Frank
 Cullen Joseph P. salesman, 40 State, house
 24 Emmett
 Cullen Julia, widow, boards Mill cor. Platt
 Cullen Margaret, deceased March, 1876

HENRY C. WISNER,

CLOCKS--AGENCY FOR ANSONIA CLOCK CO.,
 No. 33 STATE STREET.

- Cullen Michael, laborer, house 11 Gorham
 Cullen Patrick, gasman, h. 133 N. St. Paul
 Cullen Patrick H. shoemaker, 87 N. Water, boards 58 Pinnacle avenue
 Cullen Peter, gardener, house 37 Comfort
 Cullen Richard, mason, h. 96 University av.
 Culligan John, laborer, h. Hague cor. R. R.
 Culligan John jr. laborer, b. Hague c. R. R.
 Culligan Michael, laborer, Powers' bldgs. (basement), house 37 Platt
 Culligan Nora, domestic, boards 23 Bolivar
 Culligan Patrick, fireman, Powers' bldgs. (basement), h. 75 Whitney [Maple
 Culligan Patrick, foreman, 116 Mill, h. 113
 Cullinan John F. engineer, City Hall, house 7 Hawkins
 Cullinan Michael, carpenter, h. 27 Saxton
 Culross Alexander, baker, 130 South St. Paul, house do.
 Culross Henry P. brakeman, b. 32 Lake av.
 Culross James R. baker, 307 State, house 32 Lake avenue [Lake av.
 Culross Newman, clerk, 307 State, boards 32
 Culross Thomas A. baker, 307 State, boards 32 Lake avenue [41 Platt
 Culver Bezalief, engineer, 22 S. St. Paul, h.
 Culver Joseph Z. real estate, 42 Arcade, h. 49 William [house 1 James
 Culver Madison, horse shoer, 3 North av.
 Culver Marvin A. farmer, house East avenue near Vick park [n. Stillson
 Culver P. Celinda, widow, boards 6 E. Main
 Culver Wm. M. carpenter, h. 115 South av.
 Cumings Wm. H. freight agent, N. Y. C. R. R. Platt cor. Kent, bds. Congress Hall
 Cummmerow Charles, laborer, house 95 Meigs
 Cummings Cornelius, waiter, Clinton Hotel, boards 22 Brown
 Cummings Frank M. painter, h. 99 N. Union
 Cummings George, foreman, N. Y. C. round house, Brown cor. Jones, house 50 Jay
 Cummings George H. machinist, Brown cor. Jones, boards 50 Jay
 Cummings Harmon C. clerk, house 57 Troup
 Cummings Henry, laborer, b. 141 S. St. Paul
 Cummings Julia Miss, 205 Plymouth avenue, boards 28 Champlain
 Cummings Lawrence, laborer, bds. 16 Allen
 Cummings Mary A. Miss, label cutter, 205 Plymouth avenue, bds. 28 Champlain
 Cummings Mary E. Miss, h. Bay n. Goodman
 Cummings Michael, Mechanics' Hotel, 10 Platt
 Cummings Patrick H. stone cutter, house 28 Champlain [bds. 42 Smith
 Cummings Patrick J. expressman, 83 State,
 Cummings Wm. saloon, 63 Orchard, h. do.
 Cundey Mary A. boards 9 North avenue
 Cunnean James, shoemaker, 73 N. Water, boards 26 McDonald avenue
 Cunnean Kate A. Miss, teacher, Andrews School, No. 9, bds. 26 McDonald av.
 Cunnean Mary D. Miss, tailoress, boards 26 McDonald avenue [av.
 Cunnean Michael, laborer, h. 26 McDonald
 Cunnean Michael, laborer, house 147 Brown
 Cunnean Thomas H. shoemaker, house 26 McDonald avenue
 Cunningham Alice, widow, h. r. 20 Griffith
 Cunningham Alice M. Mrs. hair work, 58 Saxton near Jay, house do.
 Cunningham Ann, widow, h. 26 Chatham
 Cunningham A. Mrs. widow, b. 1 Genesee
 Cunningham Charles E. bookkeeper, 3 Canal, boards 5 do.
 Cunningham Adelia Miss, house 256 E. Main
 Cunningham Elisha B. house 218 North
 Cunningham Ferdinand S. hair dresser, 43 East Main, house 66 Adams
 Cunningham Francis, laborer, h. 18 Comfort
 Cunningham George W. painter, b. 1 Genesee
CUNNINGHAM JAMES & SON (*Jos. T. Cunningham*), carriage and hearse manufacturers, 3 Canal, house 5 do.—*See page 610*
 Cunningham John C. painter, 3 Canal, house 58 Prospect
 Cunningham Joseph T. (*James Cunningham & Son*), 3 Canal, boards 5 do.
 Cunningham Lorenzo A. coachmaker, house 114 Clifton [135 Frank
 Cunningham Lyman M. clerk, 327 State, h.
 Cunningham Marion F. tailor, b. 218 North
 Cunningham Mary Mrs. grocer, 108 Jay, house do.
 Cunningham Michael, cigar maker, Mill cor. Factory, house 80 Caledonia avenue
 Cunningham Michael, bookseller, 96 State, house 48 Adams [av.
 Cunningham Nellie, widow, bds. 32 Monroe
 Cunningham Perry W. tinsmith, 144 East Main, boards 218 North
 Cunningham Peter, teamster, h. 30 Walnut
 Cunningham Philander, track master, N. Y. C. R. R. depot, house 62 South av.
 Cunningham Rosanna, widow, house 3 Green
 Cunningham Stephen, laborer, 187 W. Main, house 20 Champlain [b. 3 Green
 Cunningham Thomas F. clerk, 144 E. Main,
 Cunningham Vincent W. bookkeeper, b. 62 South avenue
 Cunningham Wm. house 23 Chatham
 Cunningham Wm. H. switchman, N. Y. C. R. R. house 58 Saxton
 Cunningham William J. cellarman, Atwater c. N. Water, h. 61 Hudson [h. Jennings
 Curlett Edward, carver, Aqueduct n. canal,
 Curlett Thomas, laborer, house 115 Chatham
 Curlett Wm. H. carver, 184 State, h. 5 Hope
 Curn Frederick, moulder, h. Orchard near Campbell [Main, h. 5 Gibbs
 Curr John (*Sibley, Lindsay & Curr*), 73 East
 Curran Catharine, widow, house 107 Jones
 Curran Charles, engineer, boards 34 Oak
 Curran Daniel, laborer, house 56 Spring
 Curran Daniel jr. blacksmith, 3 Canal, bds. 56 Spring
 Curran Elizabeth, widow, house 97 Lyell
 Curran Francis, laborer, boards 62 Exchange
 Curran Henry, engineer, h. 21 Magne n. Jay
 Curran James, laborer, house Champion c. Fulton av. [Fulton av.
 Curran James, teamster, b. Champion cor.
 Curran James, cooper, Brown's alley, b. 107 Jones [4 Jones
 Curran James H. (*Curran & Johnson*), house

Curran John, carriage painter, h. 84 Troup
 Curran John, laborer, Exchange opp. Troup, house 36 Hunter
 Curran Michael, laborer, Paper Mill, h. 37 Thompson
 Curran Patrick H. grocer, 56 Spring, h. do.
 Curran Richard (*Curran & Goler*), h. 49 Oak
 Curran Rose A. dressmaker, b. 107 Jones
 Curran William, cooper, 1 St. James' park, boards 107 Jones
 Curran & Goler (*R. Curran and G. W. Goler*), druggists, 96 West Main
 Curran & Johnson (*J. H. Curran and T. B. Johnson*), machinists, 4 Janes
 Currie John, removed to Scotland
 Currie Robert, moulder, house 120 Oak
 Currier George W. house N. Clinton corner Bloomingdale avenue
 Currier Richard, boarding house, 224½ East Main
 Currier Wm. E. machinist, Brown c. Jones, boards 76 Frank
 Curry Andrew B. laborer, Crescent Mills, h. 52 Saratoga avenue near Costar
 Curry Sarah E. dressmaker, b. 52 Saratoga avenue
 Curry Thomas W. flour packer, Model Mills, b. 52 Saratoga av. n. Costar
 Curry William, laborer, b. 54 West avenue
 Curscadden Thomas, b. 34 Plymouth avenue
 Curtice Bros. & Mack (*E. N. and S. G. Curtice and F. M. Muck*), fruit, 134 N. Water
 Curtice Carrie, student, boards 5 East
 Curtice Delia Miss, principal, Glenwood School No. 7, h. 5 East [5 East
 Curtice Edgar N. (*Curtice Bros. & Mack*), b.
 Curtice Simeon G. (*Curtice Bros. & Mack and Z. C. Curtice & Co.*), h. 5 East
 Curtice Ziba C. & Co. (*S. G. Curtice*), boarding stable, r. 1 Franklin, b. 5 East
 Curtin Cornelius, car coupler, bds. 47 Hunter
 Curtin Edmond, car coupler, house 47 Hunter
 Curtin Ellen, dressmaker, boards 28 Jones
 Curtin Ellen, widow, house 12 Walnut
 Curtin James F. machinist, Brown c. Jones, boards 12 Walnut
 Curtin Mary, widow, house 5½ Magne
 Curtin Mary, widow, house 28 Jones
 Curtin Michael, shoemaker, 27 Walbridge's block, house 9 Ward [b. do.
 Curtin Thomas J. patrolman, House of Refuge,
 Curtis Amy Mrs. boarding house, 84 East av.
 Curtis Carrie E. Mrs. house 82 State
 Curtis C. M. Mrs. principal, Livingston Park Seminary, 45 Spring, house do.
 Curtis Eugene T. (*Couples, Curtis & Co.*), 15 Mill, h. 14 E. Main n. Gibbs
 Curtis George B. sailmaker, 42 Exchange, h. 134 Adams
 Curtis George E. boards 11 Mortimer
 Curtis Hannah Miss, clerk, bds 104 Adams
 Curtis Henry R. lawyer, 99 Powers' bldgs. boards 18 North Clinton
 Curtis Ida M. Miss, boards 17 Scio
 Curtis Ira J. carpenter, h. Carter n. North av.
 Curtis James, upholsterer, 184 State, b. 180 do.
 Curtis Jennie A. Mrs. dressmaker, 17 Scio, house do.

CURTIS JOHN L. physician, 183 Powers' bldgs. house at Batavia.—*See page 592*
 Curtis Joseph, pres. and treas. Union & Advertiser Co. 82 W. Main, h. 23 Fitzlugh
 Curtis Julia Miss, house 34 Greig
 Curtis Lewis, clerk, house 80 Mt. Hope av.
 Curtis Patrick J. mason, house 12 Savannah
 Curtis Philip H. sec'y and treas. Rochester Fear Stone Co., Mt. Hope av. opp. Hamilton place, house 45 Spring
 Curtis William, house 64 Chestnut
 Curtis Wm. L. mason, boards 47 Kirk
 Curtis William W. (*Curtis & Co.*), boards 170½ West Main
 Curtis & Co. (*W. W. Curtis and I. C. McWhorter*), grocers, 90 West Main
 Curtiss Caroline, widow, house 37 Savannah
 Curtiss Charles E. pumpmaker, boards 37 Savannah
 Curtiss Cynthia E. widow, house 278 North St. Paul
 Curtiss Daniel F. contractor, house 31 Adams
 Curtiss George G. washing machines, 131 N. Water, house 52 Magne
 Curtiss Jay C. D. clerk, 4 Exchange, h. 70 Adams
 Curtiss Lewis F. removed to Syracuse
 Curtiss Sarah J. teacher, Carthage School No. 8, b. 278 N. St. Paul
 Curtiss Walter E. photographer, house 115 Broadway
 Curtiss, see Curtis and Curtice
 Cushman Abram H. grocer, 280 State, house 27 Jay
 Cushman Charles K. clerk, 16 State, boards 14 Scio
 Cushman Emma E. stitcher, bds. 7 Mathews
 Cushman Euphemia C. Mrs. h. 32 N. Clinton
 Cushman Henry G. foreman, 1 Aqueduct, b. 31 Court
 Cushman Jennie E. boards 7 Mathews
 Cushman John, cartman, h. Childs n. R. R.
 Cushman Orinda Mrs. boarding house, 31 Court, house do.
 Cusick Ellen, domestic, Osburn House
 Cusick Paul, cigar maker, 147 E. Main
 Cuthbert Nellie, stitcher, bds. 228 North av.
 Cutler Alexander K. clerk, b. 7 Centre park
 Cutler Harriet Miss, boarding house, 27 N. Clinton
 Cutler Homer L. clerk, 77 Front, boards do.
 Cutler James B. clerk, boards 7 Centre park
 Cutler James G. (*Warner & Cutler*), 64 Powers' buildings, house 17 Meigs
 Cutler Jeremiah, deputy county clerk, at Court House, house 7 Centre park
 Cutler William M. bookkeeper, 87 N. Water, boards 17 Mortimer
 Cutting Edward A. veterinary surgeon, 5 North av. boards do.
 Cutting Miles G. removed to Mendon
CUTTING WILLIAM, veterinary surgeon and (*Cutting & Cooney*), 5 North av. h. do.—*See page 602*
 Cutting & Cooney (*W. Cutting and D. E. Cooney*), blacksmiths, 5 North av.
 Cutts Samuel, shoemaker, 77 N. Water, bds. 22 Adams

DADY KATE, domestic, boards 140 Alexander
 Dagan George, shoemaker, 79 N. Water, b.
 107 Champlain
 Dagge Edward (*Frost & Co.*), Frost av. cor.
 Olean, house 136 Mt. Hope avenue
 Dagge John E. clerk, h. 3 Mt. Hope avenue
 Daggis Alfred D. butcher, 329 State, boards
 Lyell corner Moulson
 Daggis George H. butcher, 329 State, b. do.
 Daggis George O. butcher, h. Klinck near
 Erie canal [Erie canal
 Daggis George R. teamster, bds. Klinck near
DAGGS WILLIAM K. market, 329 State,
 h. Lyell cor. Moulson.—*See page 557*
 Dailey John, vinegar maker, b. 66 West av.
 Dailey Joseph, removed to Geneseo
 Dailey Martin J. clerk, boards 13 Lawrence
 Dailey Mary Ann, widow, h. 13 Lawrence
 Dailey Mary A. Miss, boards 25 Platt
 Dailey Michael, laborer, h. 31 Munger
 Dailey Patrick, laborer, boards 9 S. Ford
 Dailey Stephen, removed from city
 Daily, see Daly
 Dake Charles, clerk, bds. 25 Hamilton place
 Dake Eliza A. widow, house 10 North av.
 Dake Embury, dep. sheriff, house 1 Draper
 Dake Jabez W. physician, 25 Hamilton pl.
 house do.
 Dake Orpha, widow, boards 25 Hamilton pl.
 Dake Vivian A. student, University of Roch.
 boards 77 Atwater [25 Hamilton place
 Dake William W. salesman, 13 E. Main, b.
 Dake William H. physician, h. 62 North av.
 Dakin Edward W. engineer, Erie Ry. house
 at Corning [3 Lancaster
 Dakin Timothy J. clerk, 144 E. Main, house
 Dale Thomas, painter, house 218 W. Main
 Da Lee Whiting J. bookkeeper, Exchange near
 Troup, boards 38 Chestnut
 Da Lee Wm. S. superintendent, Exchange n.
 Troup, house 38 Chestnut
 Daletz Mary, tailoress, boards 73 Chatham
 Daley Armie, widow, boards 5 Briggs pl.
 Daley Cornelius, hostler, 6 Lancaster, house
 4 Plymouth avenue
 Daley Daniel, blacksmith, h. 3 Fullam's pk.
 Daley Daniel jr., shoemaker, b. 3 Fullam's pk.
 Daley Daniel P. blacksmith, house 20 Stone
 Daley Harry, ass't scenic artist, Opera house
 Daley Michael, laborer, house 7 Romeyn
 Daley Robert, driver, 264 State, b. 24 Smith
 Daley Timothy, machinist, house 308 State
 Dalrymple Augustus, deceased
 Dalton Albert J. shoemaker, 83 N. Water,
 house 29 St. Joseph
 Dalton Eliza, widow, house 15½ Monroe av.
 Dalton James, carpenter, house 12 Cameron
 Dalton James jr. carpenter, house 8 Cameron
 Dalton Mary, widow, house 3 Munger
 Dalton Mary, removed from city
 Dalton Michael, collarmaker, 77 State, bds.
 3 Munger [3 Munger
 Dalton Patrick, sawyer, 13 Warehouse, bds.
 Dalton Peter, removed to Auburn
 Dalton Sarah, removed from city
 Daly Austin, laborer, boards 67 Orange
 Daly Bartholomew, laborer, house 65 Davis
 Daly Bridget, widow, boards 249 State

Daly Elizabeth, widow, h. Lyell n. Myrtle
 Daly Henry, cooper, house 21 Fulton avenue
 Daly James, teamster, house 91 Davis
 Daly James, laborer, Brown c. Jones, house
 67 Orange
 Daly Jeremiah, shoemaker, h. 31 Childs
 Daly John, cooper, boards 21 Fulton avenue
 Daly John, porter, 71 State, h. 110 Hunter
 Daly Joseph, shoe finisher, 73 North Water,
 boards 31 Childs
 Daly Kate, forewoman, boards 21 Fulton av.
 Daly Kate, domestic, boards 10 North Union
 Daly Margaret, sewer, boards 124 Meigs
 Daly Mary, widow, house 59 Lime
 Daly Mary E. dressmaker, b. Lyell n. Myrtle
 Daly Michael, laborer, b. Lyell n. Myrtle
 Daly Patrick, house 3 East park
 Daly Patrick, switchman, boards 91 Davis
 Daly Patrick, gas fitter, b. Lyell near Myrtle
 Daly Patrick, laborer, boards 67 Orange
 Daly Peter, teamster, 42 E. Main, house 35
 Manhattan [29 Hill
 Daly Robert W. salesman, 73 State, house
 Daly Rose A. grocer, 249 State, house do.
 Daly Thomas, brakeman, b. Lyell n. Myrtle
 Daly Thomas, clerk, 93 State, h. 72 S. Union
 Daly Thomas P. tinsmith, house 36 Griffith
 Dalzell Isabell A. Miss, stitcher, bds. Scrantom
 corner Conkey avenue
 Dalzell William J. b. Norton n. N. St. Paul
 Dammon Carrie, housekeeper, bds. 33 Meigs
 Damon Charles, baggageman, N. Y. C. R. R.
 boards 18 John [bds. do.
 Damon Edmund T. cigarmaker, 3 Eagle,
 Damon Edward H. cigarmaker, 3 Eagle, b. do.
 Damon George, roofer, boards 102 Front
 Damon John H. removed to Massachusetts
DAMON MARY J. cigar manuf. 3 Eagle,
 house do.—*See page 565*
 Damotte Frank, machinist, house 31 Scio
 Dana Amy, widow, house 48 Pearl
 Dana Charles, baggageman, h. 126 Broadway
 Dana C. Frank, fireman, N. Y. C. R. R. b.
 126 Broadway [89 Broadway
 Dana John H. policeman, City Hall, house
 Dana Martin V. B. carpenter, h. 90 Pearl
 Dana Seymour G. telegrapher, 34 Arcade, b.
 89 Broadway [Broadway
 Dana William H. carrier, Post Office, h. 87
 Dancy Jesse E. machinist, house 2 Clark
 Dancy William H. engineer, N. Y. C. R. R.
 house 4 Channing
DANFORD ALLEN & SON (*Geo. Danford*),
 turners, N. Water n. R. R. h. Averell n.
 Broadway.—*See page 558*
 Danford George (*A. Danford & Son*), house
 9 Hamilton place
 Danforth Elizabeth C. widow, h. 55 Weld
 Danforth Frances E. stitcher, bds. 55 Weld
 Danforth George F. (*Danforth & Shepard*),
 43 Powers' bldgs. h. West av. n. Ames
 Danforth Halsey J. h. Court n. Chestnut
 Danforth & Shepard (*G. F. Danforth and W.
 H. Shepard*), lawyers, 43 Powers' bldgs.
 Dange Louis, laborer, boards 81 Mill
 Danfell Charles H. trimmer, 76 Mill, boards
 135 Frances
 Daniell George, shoemaker, b. 38 Lowell

- Daniell John R. deceased March 31, 1876
 Daniell John R. jr. cutter, 25 Mill, b. Frances corner Strong
 Daniell Mary M. widow, h. Frances c. Strong
 Daniels Eli H. & Son (*H. C. Daniels*), stable, 4 Caledonia av. h. 94 West av.
 Daniels Henry C. (*Daniels & Phillips*), 18 W. Main, b. 143 Plymouth av.
 Daniels Howard C. (*E. H. Daniels & Son*), boards 94 West avenue
 Daniels Louisa M. principal Oakman School, No. 20, boards 135 Frank
 Daniels Matilda L. widow, house 135 Frank
 Daniels & Phillips (*H. C. Daniels and C. D. Phillips*), publishers Rochester Times, 18 West Main
 Danielsen Jacob, student, Rochester Theological Seminary, bds. 118 Alexander
 Danihy John, news agent, N. Y. C. R. R. depot, house 43 Joiner
 Daningburg William, policeman, City Hall, house 58 Pearl
 Dank Frederick, cabinetmaker, h. Bethlehem park [place
 Dank Henry T. tailor, boards 10 Elizabeth
 Dank John, laborer, house 10 Elizabeth pl.
 Danks Daniel, bracket maker, h. Martin cor. Hart avenue
 Danley Florence, widow, b. 34 Monroe av.
 Dann Archibald, physician, 45 E. Main, h. 50 South avenue [burgh, b. do.
 Dannels H. Eva, children's school, 16 Edin-
 Dannels Richard M. carpenter, 177 Plymouth av. h. 16 Edinburgh
 Danner Christopher, waiter, Osburn House
 Danny William, laborer, house 161 South av.
 Danny Wm. J. machinist, bds. 161 South av.
 Danzer Henry, file cutter, boards 18 Lowell
 Danzer John, shoemaker, 75 N. Water, bds. 21 Childs
 Danzer John G. grinder, house 18 Lowell
 Danzer Joseph, painter, 3 Canal, b. 21 Childs
 Danzer Stephen, baker, 21 Childs, house do.
 Danzig Abraham A. ladies' suits, 1 E. Main, house 65 N. St. Paul
 Dapper Peter, teamster, house Norton near Hollenbeck [102 Frank
 Darby John E. scalemaker, 5 Andrews, bds.
 Dare William, teamster, house 151 Fitzhugh
 Darling Elizabeth, widow, b. 49 University avenue
 Darling George, house 37 Sophia [Matthews
 Darling Laura M. Miss, tailoress, house 20
 Darling Mary Mrs. house 30 Andrews
 Darling Mary E. widow, house 9 Dean
 Darling Richard A. tollgate keeper, Mt. Hope avenue, house do.
 Darling Robert H. laborer, boards 9 Dean
 Darling Sidney A. clerk, paper mill, house 17 Phelps avenue
 Darling William S. railroad agent, 92 Mill, house 90 Cypress [Cypress
 Darling W. Emmett, packer, 74 State, b. 90
 Darraff Dennis, moulder, 8 Hill, house rear 1 Campbell
 Darragh Ann E. widow, b. 5 Greenwood av.
 Darrer Charles, cigarmaker, 104 N. Clinton, boards 150 St. Joseph
 Darrer Florian, baker, 113 East Main, b. 30 Thomas [Hastings
 Darrow Bridget, widow, house Champion c.
 Darrow Charles E. student, University of Rochester, boards 46 Franklin
 Darrow Electa Miss, boards 8 Joslyn park
DARROW ERASTUS, bookseller and stationer, Osburn House block, 67 East Main, h. 46 Franklin.—*See page 518*
 Darry James, laborer, State c. Centre, b. Lyell near Whitney [house 95 do.
 Dart Edward, carpenter, 107 S. St. Paul
 Dart John, carpenter, house 61 South av.
 Dasson Peter, boatbuilder, h. 50 Savannah
 Dates Emma, gilder, 88 Gorham, b. Clifford
 Dates Frank H. clerk, 83 State, h. 91 Adams
 Dates John H. machinist, Mill c. Factory, b. 28 Clifford [28 Clifford
 Dates Thomas, engineer, Mill c. Factory, h. Dates Thomas L. machinist, Mill c. Factory, boards 28 Clifford [Bay
 Dattmann Charles, teamster, h. Goodman n.
 Daub Barbara, domestic, boards 9 Park av.
 D'Aubigne Mary A. widow, house 50 Court
 Daucase John, mason, house 49 Front
 Daus Matthew, grocer, 62 Lyell, house do.
 Davenport Eliza, widow, h. 153 Caledonia av.
 Davenport William H. carpenter, house 160 West Main [153 Caledonia av.
 Davenport William H. painter, 12 Stone, h.
 Davenport, see Devenport and Deavenport
 David Marcus J. assistant bookkeeper, 14 Mumford, boards 51 Atwater
 Davidson Adam D. salesman, 73 East Main, boards 119½ do.
 Davidson Alexander, removed to Syracuse
 Davidson Annie Miss, clerk, bds. 1 Madison
 Davidson J. Mrs. widow, house 1 Madison
 Davies Wm. miller, Granite Mills, b. 38 Allen
 Davis Alfred L. foreman job rooms, 3 West Main, house 16 Cypress [Cypress
 Davis Alfred W. printer, 3 W. Main, b. 16
 Davis Almira, widow, boards 8 Frank
 Davis Alonzo B. painter, house 28½ Henry
 Davis A. Dixon, clerk, 85 Exchange, house 13 Chestnut park
 Davis Charles A. real estate, 37 Powers' buildings, house 30 Concord avenue
 Davis Charles G. market, 126 East av., h. 17 Gardiner park
 Davis Charles H. bookkeeper, b. 8 Howell
 Davis Charles H. clerk, postoffice, b. 58 Frank
 Davis Charles R. deputy collector internal revenue, 7 Powers' buildings, house 3½ Chestnut park
 Davis Charles S. (*Walters & Davis*), 1 Smith's block, boards 35½ Charlotte [Frost av.
 Davis Daniel, physician, 110 State, house 4
DAVIS DANIEL P. contractor, 73 S. St. Paul, house 8 Howell.—*See page 591*
 Davis D. P. bookkeeper, 36 Exchange, house 13 N. Union
DAVIS EDWARD H. druggist, 81 State, house 12 Trowbridge.—*See front cover*
 Davis Edward J. removed to Toronto, Ont.
 Davis Ellen, widow, house rear 8 Kirk
 Davis Frank W. (*Davis, Moulton & Co.*), 36 Exchange, house 115 Fitzhugh

HENRY C. WISNER,

WHITE CHINA DINING and TEA SETS,
 No. 33 STATE STREET.

Davis Franklin P. moulder, 20 Court, bds. 19 Orchard
 Davis Frederick, house 303 East Main
 Davis George, boards 126 Monroe avenue
 Davis George, streetspaver, house 30 Kent al.
 Davis George C. 111 State, boards Whitcomb House [W. Main
 Davis George H. salesman, 9 State, b. 146½
 Davis George P. (*Davis & Leyden*), house 23 Concord avenue
 Davis George T. (*Kingsbury & Davis*), Shawmut buildings, house 41 South Ford
 Davis Gilman R. student, University of Rochester, boards 17 Marshall
 Davis Harry, bookkeeper, house 50 Court
 Davis Henry, watchman, house 24 W. Smith
 Davis Henry, piano tuner, house 104 Scio
 Davis Henry S. turner, house 28½ Henry
 Davis Hiram, house 96 Hudson [170½ do.
 Davis Horace W. clerk, 102 W. Main, bds.
 Davis H. Wheeler (*Davis, Jennings & Co.*), house 13 Rowley
 Davis Irwin T. removed to Hartford, Ct.
 Davis Jane, widow, boards 126 Mt. Hope av.
 Davis Jennie, widow, house 37 E. Maple
 Davis, Jennings & Co. (*J. G. Davis, E. B. Jennings and H. W. Davis*), millers, Jefferson Mills, foot Factory
 Davis Joel G. (*Davis, Jennings & Co.*), Brown's race foot Factory, house 50 Oak
 Davis John A. clerk, 7 Powers' buildings, b. 3½ Chestnut park [h. Myrtle n. Lyell
 Davis John B. trackmaster, N. Y. C. R. R.
 Davis John H. printer, 3 West Main, bds. 16 Cypress [n. West av.
 Davis John W. carpenter, house 4 Litchfield
 Davis Joseph W. carpenter, h. 185 N. St. Paul
 Davis Josiah B. carpenter, Oak n. R. R. h. 121 Bartlett
 Davis Julia M. widow, boards 50 Oak
 Davis Justin B. bookkeeper, b. 10 Pleasant
 Davis Lewis E. salesman, 53 E. Main, bds. Clinton Hotel
 Davis Margaret, widow, h. 39 Edinburgh
 Davis Maria N. widow, boards 2 Clarissa
 Davis Mary, widow, house 133 East Main
 Davis Mary A. widow, boards 8 Mortimer
 Davis Mary C. widow, house 28 Smith
 Davis Matie, dressmaker, bds. 74 North av.
 Davis Michael, laborer, boards 30 Kent
 Davis Minnie, dressmaker, boards 88 Scio
DAVIS, MOULTON & CO. (*F. W. Davis, D. Moulton and J. C. Carr*), wholesale boots and shoes, 36 Exchange.—*See page 666* [Brockport
 Davis M. H. salesman, 14 Front, house at
 Davis Nancy Mrs. house 19 Orchard
 Davis Philanda, widow, h. 30 Concord av.
 Davis Sarah, tailoress, boards 30 Kent alley
 Davis Sarah J. widow, house 23 Brown
 Davis Spellman U. removed from city
 Davis Wait H. house 8 Frank
 Davis William, miller, boards 38 Allen [Elm
 Davis Wm. bookkeeper, 55 S. St. Paul, b. 9
 Davis William B. carpenter, h. 176 N. Union
 Davis William B. bookkeeper, 1 Powers' buildings, b. 28 Smith [Trowbridge
 Davis William C. clerk, 81 State, boards 12

Davis Wm. D. clerk, 102 W. Main, b. 170½ do.
 Davis William H. nurse, house 26 Clifton
 Davis William H. laborer, bds. 19 Orchard
 Davis Wm. H. tuner, 42 Buchan pk. h. do.
 Davis Wm. J. foreman, 83 N. Water, boards 39 Edinburgh [3½ Chestnut
 Davis Wm. L. carver, 133 N. Water, boards
 Davis Zimri L. lawyer, 61 Arcade, house 10 Pleasant [dental stock, 93 State
 Davis & Leyden (*G. P. Davis and M. Leyden*), Davison Belle, dressmaker, 31 Fitzhugh, h. do.
 Davison Christopher C. (*Chumaseiro & Davison*), 158 Powers' bldgs. h. 41 Clinton pl.
 Davison Cornelia L. widow, h. 10 Chestnut park [Chestnut park
 Davison Frank C. telegrapher, 4 State, h. 10
 Davison Solomon W. physician, 138 E. Main, house 41 Scio
 Davisson A. W. h. Oakland c. Mt. Vernon av.
 Davoren Maria, widow, boards 19 Bolivar
 Davy John M. (*Davy & Luckey*), 106 Powers' bldgs. house 42 Marshall
 Davy Mary, stitcher, boards 9 Ward
 Davy & Lucky (*J. M. Davy and J. L. Luckey*), lawyers, 106 Powers' bldgs.
 Dawe Herbert J. (*Dawe & McCormick*), house 38 Fulton avenue
 Dawe Javus, gardener, bds. 170½ W. Main
 Dawe & McCormick (*H. J. Dawe and D. McCormick*), tinsmiths, 328 State
 Dawes Harrison J. supt. 36 State, bds. Whitcomb House [h. do.
 Dawes Joseph, artificial limbs, 170 West av.
 Dawson Julius, truss maker, 147 Powers' bldgs. house 20 Atkinson
 Dawson Sarah Mrs. h. 7 John [Sibley's blk.
 Dawson Sarah A. Mrs. milliner, house 5
 Dawson Thomas, agent, house 15 Gregory
 Dawson Thomas F. fireman, N. Y. C. R. R. boards 38 Kent [h. 3 Jones
 Dawson Wm. H. engineer, N. Y. C. R. R.
 Day Alfred (*Day & Bronson*), 133 East Main, house 135 do.
 Day Benjamin, agent, h. 161½ West Main
 Day Charlotte S. widow, house 47 Spring
 Day Franklin E. lumber, house 138 Frank
 Day Hannah Mrs. deceased Nov. 1875
 Day Harper R. painter, boards 21 Strong
 Day Helen, Miss, dressmaker, house 32½ Franklin
 Day James, stable, 4 Otsego, house 169 State
 Day Mary Mrs. house 4 Plymouth avenue
 Day Norman, steward, Clinton Hotel, b. do.
 Day Theodore S. student, University of Rochester, boards Culver pk. near East av.
 Day William B. painter, 5 Spring, house 21 Strong
 Day Zorrada, boards 91 South St. Paul
 Day & Bronson (*Alfred Day and Henry Bronson*), confectionery, &c. 133 East Main
 Dayton W. G. shoemaker, Penitentiary, h. 21 Linden [North av.
 Deady William, miller, Model Mills, h. 46
 Deady William H. salesman, 61 West Main, boards 46 North avenue
 Dean Charles F. lawyer, 19 Smith's block, boards 35 North avenue
 Dean Daniel, mason, house 109 Scio

A. R. PRITCHARD & LIKLY,

FINE MOROCCO SATCHELS,
 No. 78 STATE STREET.

Dean Eliza M. vestmaker, boards 109 Scio
 Dean Fred M. student, University of Rochester, boards 33 Fitzhugh [do.
 Dean Henry W. physician, 33 Fitzhugh, h.
 Dean John, laborer, house Monroe avenue corner Boardman [Martin
 Dean John, policeman, City Hall, house 65
 Dean John J. painter, boards 109 Scio
 Dean Matilda J. Mrs. house 66 Exchange
 Dean Robert W. painter, boards 109 Scio
 Dean Wm. K. student, University of Rochester, boards 33 Fitzhugh [Ames
 Deatmeyer John, farmer, h. W. Orange n.
 Deavenport Charles A. clerk, b. 10 Chestnut
 Deavenport Daniel (*Deavenport & Hale*), h. 117 East-avenue
 Deavenport & Hale (*D. Deavenport and E. E. Hale*), grocers, 163 East Main
 De Back Carrie, domestic, b. 18 Arnold pk.
 De Bell Edwin T. student, University of Rochester, boards 34 Gibbs [ney
 Debin Frederick, cabinetmaker, b. 57 Whit-
 Debin John, cabinetmaker, h. 57 Whitney
 De Blaawe Isaac, carpenter, Minerva al. bds. 2 Holland [Holland
 De Blaawe John, carpenter, Minerva al. b. 2
 De Blaawe Mary, widow, house 2 Holland
 Deborg Albert, carpenter, Minerva al. house Goodman [Hudson
 De Bruyn Cornelius A. shoemaker, bds. 137
 De Bruyn Adriaan, house 137 Hudson
 De Bruyn Cornelius, carpenter, h. 5 Rhine
 De Bruyn Leonard, carpenter, house 290 St. Joseph [Church, house 10 Kirk
 De Bruyn Peter, pastor Holland Reformed
 Debus Catharine, saloon, 6 Ford, house do.
 Debus George L. stonecutter, bds. 6 N. Ford
 De Bus Michael, laborer, boards 81 Mill
 Debus Philip, laborer, house 54 West Smith
 De Chantal Mary Sister, St. Bridget's School, boards Jay corner Frank
 Dechmann Nicholas, foreman, 114 W. Main, house 92 Campbell
 Decke Henry, laborer, house 18 Wilson
 Decker Abraham jr. painter, h. 48 Ontario
 Decker Frances M. Miss, teacher, Riley School, No. 14, boards 115 N. St. Paul
D ECKER FRANK, Baggage and Transfer Co., N. Y. C. Depot, and West Main corner Exchange, house 13 Fitzhugh.—
See page 572
 Decker Frederick, cabinet maker, house 75 Campbell [9 Tyler
 Decker George C. dentist, 47 East Main, b.
 Decker Jacob, removed to Canandaigua
 Decker Jennie, stitcher, boards 76 Court
 Decker John, cabinetmaker, h. 83 Campbell
 Decker John, painter, 14 Stone
 Decker John C. removed to Bergen
 Decker Marshall, baggage express, house 13 Fitzhugh
 Decker Miles, bookkeeper, house 9 Tyler
 Decker Richard, turner, lower falls, house 9 Hastings avenue [332 State
 De Clercq Hubert, teacher, 10 Vought, bds.
 De Cook James, baker, 225 North, house do.
 De Coombes Ambrose, cabinet maker, Jay corner Erie canal, boards 40 Lorimer

Dee Ellen, widow, house 45 Griffith
 Dee Thomas, tobacconist, 55 South St. Paul, house 45 Griffith [St. Paul
 Deegan Edward M. laborer, boards 176 N.
 Deegan Patrick, grocer, 331 State, bds. 176 North St. Paul
 Deer Adam, laborer, house 3 Sauer's park
 Deer Andrew, butcher, house 153 Hunter
 Deer John G. boxmaker, foot Aqueduct, h. 129 South avenue
 Defendorf Almira, boards 58 Lake avenue
 Defendorf Jesse, carpenter, foot Ambrose, house do. [Lake av.
 Defendorf John A. salesman, 69 State, b. 58
 Defendorf Maria, widow, house 58 Lake av.
 Defendorf Myron E. carpenter, boards foot Ambrose [4 Evergreen pk.
 Defendorf Nelson, bed springs, 324 State, h.
 Defendorf Willard E. shoemaker, 81 North Water, boards foot Ambrose
 Defendorf, see Diefendorf [h. 35 Vienna
 Deffner John, shoemaker, River n. N. Water,
 De Flear Isaac, gardener, boards 1 Oregon
 De Forrest Isaac, pumppmaker, boards Sibley near Bates [Bates
 De Forrest James, teamster, house Sibley n.
 De Forrest Lydia A. Mrs. nurse, house East Main corner Lancaster [Wis.
 De Forrest Richard, removed to Whitewater,
 De Garmo Daniel, foreman, 100 S. St. Paul, house 24 West Alexander
 De Garmo Eddy A. Miss, h. 130 S. St. Paul
 De Garmo Elias, house 7 Prospect
 De Garmo Peter, house 34 Gibbs
 De Garmo Robert, grocer, 69 West avenue, house 17 Prospect
 De Garmo Theron F. book keeper, 25 Exchange, boards 22 Gibbs
 De Garmo William J. removed from city
 De Graaf Peter, laborer, house 7 Wadsworth
 De Graaf Simon, laborer, h. 7 Wadsworth
 De Graff Margaret M. domestic, b. 20 Frank
 De Gray Christina, widow, b. 231 Exchange
 De Groff Abram, house 71 South Ford
 De Haven Rhoads, salesman, h. 56 Park av.
 Dehner John, basket maker, h. W. Orange near Ames
D EIGHT BENEDICT, stoves, tinware, &c. 97 St. Joseph, h. do.—*See page 627*
 Deihl Jacob, butcher, house Lake av. cor. Phelps avenue
 Deihl William, house 42 Charlotte
 Deininger Frederick, baker, 138 North av.
 Deisenroth Adam, mason, h. 17 Hamburg
 Deitz John F. blacksmith, Mill c. Platt, h. 20 Morris [b. 20 Morris
 Deitz John W. blacksmith, Mill cor. Platt,
 Deitz Mary, tailoress, boards 40 Nassau
 De Jonge Cornelius, gardener, house 233 St. Joseph
 De Jonge Cornelius, peddler, h. 2 Huntington
 De Jonge Edward (*De Jonge & Marsielje*), h. 227 St. Joseph
 De Jonge John, laborer, house 86 Kelly
D E JONGE & MARSIELJE (*E. De Jonge and A. Marsielje*), masons and contractors, 34 Buchan park.—*See page 640*
 De Jongh Henry, house 47 St. Joseph

De Jongh Henry D. carpenter, boards 47 St. Joseph [Shamrock
De Jongh Jacob S. packer, 53 State, house 8
De Jongh Reinira B. boards 47 St. Joseph
De Kempeneer Charles C. osteologist, 2 College avenue, boards 37 Weld
De Koning Adriaan I. laborer, h. 3 Holland
De Kroyft Abraham, deceased May 1875
De Kroyft Abram W. machinist, Exchange opp. Glasgow, boards 64 Oak
De Kroyft Angelina, widow, house 64 Oak
De Kroyft Parsons M. baggageman, house 142 Frank [boards 64 Oak
De Kroyft William V. woodworker, 79 State, Delahunty John, laborer, h. 27 North York
Delahunty Mary, teacher, St. Mary's Orphan Asylum [205 State
Delaney Daniel, shoemaker, 4 Allen, boards
Delaney Edward C. laborer, boards 29 Oak
Delaney Elizabeth, widow, house 29 Oak
Delaney John F. laborer, house 84 Frank
Delaney, see Dulany
Delano Anna, artist, boards 180 State
De Lano Edwin C. hostler, boards 28 Hudson
De Lano Egbert W. carpenter, West end Court st. bridge, house 44 Gregory
De Lano Frank C. clerk, h. 140 N. Clinton
De Lano Frederick, lawyer, 22 Arcade, house 34 South Clinton
De Lano Kate Miss, dressmaker, b. 19 Gibbs
De Lano Lura, widow, boards 34 S. Clinton
De Lano Marcus L. carpenter, West end Court st. bridge, h. 1 Nichols park
De Lano Olive O. Miss, bds. Nichols park
De Lano Sarah L. Miss, teacher, Glenwood School No. 7, house 3 Ambrose
Delavau John, harnessmaker, house 71 Caledonia av. [28 Allen, h. 24 Elizabeth
Delavau Joseph S. (*Dunley & Delavau*),
Delavau William W. painter, b. 71 Caledonia avenue [North Clinton
Delbridge James, cutter, 17 Front, house 66
Delby Benjamin, upholsterer, boards 5 Stone
Delby Moses, upholsterer, house 5 Stone
Delevan Mary, domestic, Osburn House
Delitz Bernhart, cabinet maker, Rowe near Lake avenue, boards 132 Hudson
Delitz Elizabeth Miss, boards 93 South av.
Dell Peter, tobacco, house rear 20 Griffith
Dell see Doell [Water, b. 84 Alexander
Dellanback Chauncey, splitter, foot North Delles Mary A. widow, b. Jay near city line
Delles Peter, scale maker, h. Jay n. Moulson
De Long George B. groom, house 10 Julia
De Long George B. teamster, h. Plymouth avenue corner Greig
De Mallie Isaac, laborer, h. 225 St. Joseph
De Mallie Isaac jr. sign painter, b. 225 St. Joseph [Goodman
De Mallie Isaac, hatter, 7 State, boards 15
De Mallie John, moulder, 187 W. Main, h. 12 Wilson [house do.
De Mallie John, grocer, Hudson cor. Vose,
De Mallie Martin, clerk, 29 West Main, h. 63 Baden [Water, b. 71 West Maple
De Marce Charles, shoemaker, 77 North
De Marce Lawrence, watchman, house 71 West Maple

De Marce Lawrence jr. blacksmith, bds. 71 West Maple [house do.
Demarest Sophia W. dressmaker, 125 State,
Demarest see Demorest
Demarrow Bridget, widow, boards 3 Stone
Demary Andrew J. clerk, 22 State, boards 30 North avenue [German
Demer Lorence, laborer, house N. Union n.
Deming Daniel F. machinist, Mill c. Factory, house 54 Alexander
Deming Jonathan H. boards 54 Alexander
Demler Joachim, laborer, h. Thomas near Clifford
Demm Ann C. widow, house 398 Brown
Demmer Engleberth, wood yard, 3 Edmonds, house 208 Monroe avenue
Demming Henry, chair caner, b. 101 Childs
Demming Wm. laborer, bds. 139 S. St. Paul
Demoll Charles, turner, 111½ North Water, boards 32 Clifford [Clifford
Demoll Maurice, finisher, 184 State, bds. 32
De Mong James H. laborer, h. 96 Clifton
Demorest Albert H. clerk, boards 51 Hickory
Demorest Isaac E. box maker, boards 148½ North St. Paul [house 51 Hickory
Demorest John, carpenter, Minerva alley,
Demorest William R. salesman, 39 State, h. 53 Hickory
Demorest see Demarest [avenue
Dempsey Catharine, widow, h. 149 Anderson
Dempsey Henry, conductor, b. 149 Anderson avenue [avenue
Dempsey James, brakeman, b. 149 Anderson
Dempsey John (*O'Neil & Dempsey*), 342 State, house 28 Phelps avenue
Dempsey John, h. Monroe av. near toll gate
Dempsey Michael, brakeman, b. 149 Anderson avenue [toll gate
Dempsey Patrick, laborer, h. Monroe av. n.
Dempsey Timothy B. bookkeeper, Monroe avenue, near toll gate, boards 312 do.
Dempsey Wm. boards Monroe av. n. toll gate
Dempster Hugh, at Gas Works, house 28 North Union [Monroe avenue
Demsey Michael, porter, h. Boardman near Dendinger Jacob, spectacle frame maker, 179 N. St. Paul, h. Maple cor. Orchard
Dendinger John, laborer, h. 3 Leavenworth alley
Deneve Anthony P. painter, house Genesee near Cottage [Baden
De Neve Cornelius P. bookbinder, house 42
De Neve Joseph C. clerk, 9 W. Main, b. 42 Baden [Joseph, house do.
De Neve Joseph C. A. physician, 54 St.
Dengler George T. clerk, 43 Exchange, bds. 275 North
Dengler Henry J. machinist, 123 Mill, b. 314 Brown
Dengler John, mason, house 78 Orange
Dengler John B. trunkmaker, foot Rowe, h. 314 Brown [house do.
Dengler Michael, matchmaker, 366 Brown,
Dengler Valentine (*Counell & Dengler*), 123 Mill, house 332 Brown
Den Hollander Jacob, carpenter, h. 22 Clifford
Denhour David, laborer, house 52 Atwater
Denio Erastus M. house 25 Stone

Denio William L. machinist, Court c. Stone, bds. 57 North av.
 Denise Don A. agent, 80 State
 Denise John, boards 15 Stillson
 Denison Lorenzo H. agent, bds. 73 S. Union
 Denison Nancy M. widow, bds. 73 S. Union
 Denman Julia, widow, house 241 East Main
 Dennebecq Constant, watchmaker, 142 East Main, h. do.
 Dennie Frank, carpenter, house 21 Andrews
 Denning Jacob, moulding maker, 43 North Water, h. 32 Vose
 Denning Mary T. h. 149½ East Main
 Denninger Andrew, teamster, h. 15 Rhine
 Dennis Frank, laborer, house 19 Lancaster
 Dennis Nellie Mrs. house 22 Asylum
 Dennis Sarah, widow, h. Lake av. n. Ridgeroad [Ridgeroad
 Dennis William, laborer, bds. Lake av. n. Ridge road
 Dennis Zina G. laborer, bds. Lake av. near Ridge road
 Denny Conrad B. druggist, house 13 Oak
 Denny John W. painter, house 46 Lyell
 Denny Wm. J. machinist, Mill cor. Factory, boards 161 South avenue
 Densmore Aden, painter, house 48 Court
 Densmore Aden, jr., clerk, boards 48 Court
 Densmore Arthur, painter, h. 115 South av.
 Densmore Ephraim, removed from city
 Densmore Louisa Mrs. dressmaker, 1 Erie, boards do. [Jennings
 Dentinger Frank, painter, h. North av. near
 Dentinger Joseph, laborer, 7 Front, h. 71 Campbell [Ill.
 Dentinger Louis C. removed to Champlain,
 Dentinger Xavier, carver, Jay c. Canal, bds. North avenue [77 S. Union
 Denton James, clothes bars, 202 State, house
 De Plaa Bastian, painter, h. 52 St. Joseph
 DePoe Joseph, contractor, h. 112 Lake av.
 DePoe Maggie, teacher, bds. 112 Lake av.
 DePoe Mary E. Miss, teacher, Franklin school, No. 6, bds. 112 Lake av.
 DePozzie Mary, Sister Superior St. Patricks Orphan Asylum
 Deprez John, laborer, house 49 Wilder
 De Puit Anthony, laborer, h. 193 Alexander
 De Puit John, carpenter, Minerva al. house 29 Goodman
 De Puit Philip, laborer, boards 29 Goodman
 De Puy Clarence, bookkeeper, bank of Monroe, 22 Exchange, bds. 109 West av.
 De Puy Clarissa, widow, house 37 Jones av.
 De Puy Teneyck, lumber, Lake av. c. Rowe, house 109 West avenue
 De Puy William H. & Co. (N. Hough), picture frame backing, 92 Allen, b. 37 Jones av.
 Derbort Frank, laborer, h. Cayuga pl. near Grand
 De Regge Hypolitus, assistant priest at St. Patrick's Cathedral, h. 42 Frank
 Derex Adam, laborer, b. 208 Pinnacle av.
 Derex Michael, collar maker, 129 State, house 7 Bond [avenue
 Derex Valentine, bricklayer, b. 206 Pinnacle
 Derham Stephen, sawmaker, 153 State, h. Smith cor. Saxton [Franklin sq.
 Derick Frank M. clerk, 18 E. Main, bds. 5

DeRidder Abraham, laborer, h. 42 Tappan
 DeRidder Isaac, tailor, 17 Front, house 35 Clifford
 Deringer Annie, widow, b. Fourth av. n. Bay
 Dermody Mary, widow, house 11 Stone
 DeRoer Carlos, cigars, 126 W. Main, b. 107½ East Main
 Deroller John, teamster, bds. 30 Franklin
 DeRoo Peter, laborer, house Clifford near St. Joseph
 DeRoo Peter jr., clerk, 30 S. St. Paul, bds. Clifford n. St. Joseph
 Derrick Timothy, merchant tailor, 14 Elwood blk., house 14 Tremont
 Derrick——, clerk, boards 25 North av.
 Derry James, laborer, boards 147 Lyell
 Desales Mary, deceased July, 1875
 Desanroth Charles, laborer, house 103 Meigs
 Desanroth Mary, tailoress, boards 103 Meigs
 De Schemes Joseph, removed from city
 Desens Lebrecht, varnisher, 74 State, h. 19 Maria
 Desmond Ellen, boards 35 Martin
 Desmond John, student, 101 Powers' bldgs., boards 43 Hickory [Hickory
 Desmond Margaret, dressmaker, boards 43
 DesRochers John M. clerk, boards 19 Oak
 Des Rochers Thomas B. clerk, 53 E. Main, house 130 N. Clinton [b. 19 Oak
 Des Rochers Wm. T. M. clerk, 45 E. Main,
 Dessautell Wm. shoemaker, River n. N. St. Paul, boards 60 Baden
 Dessens Frederick, cabinetmaker, 184 State, h. 180 St. Joseph [Joseph
 Dessens Frederic 2d, laborer, bds. 180 St.
 Detabel Emanuel, moulder, 8 Hill, h. 108 West Maple
 Dettinger John, tailor, house 13 Hamburg
 Dettloff Charlotte, widow, h. rear 27 Vienna
 Dettman John, laborer, house Wilder place
 Deuchler Ernst, cabinetmaker, 22 S. St. Paul, boards 70 Whitney
 Deuchler Jacob F. cabinetmaker, 22 S. St. Paul, h. 117 W. Maple
 Deuchler Wm. cabinetmaker, h. 70 Whitney
 Deuel Edwin A. teamster, 22 West av. b. 9 S. Ford [12 Glasgow
 Deuel John W. lawyer, 96 Powers' bldgs. h.
 Deuel Prudence R. widow, bds. 12 Glasgow
 Deuning Jacob, varnisher, house 34 Vose
 Deusing Edward, blacksmith, 194 W. Main, boards 23 Jay [house do.
 Deutsch Chas. M. vinegarmaker, 7 Clarkson,
 Deutsch George, sawyer, house 33 Nassau
 Deutsch Jacob, shoemaker, h. 96 Chatham
 Deutsch Joseph, removed to Charlotte
 Deutsch William H. saloon, West Main cor. Exchange, house 3 Joiner
 Deutsch, see Teutsch
 Devaney Mary, domestic, boards 25 Kent
 Devanport George (Devenport & Tuttle), 33 Arcade, house 156 West avenue
DEVENPORT & TUTTLE (G. Devenport and G. W. Tuttle), real estate, 33 Arcade. —See page 509
 Devereaux Ann, widow, h. Walnut n. Orange
 Devereaux John, cabinetmaker, Jay c. Erie canal, bds. Walnut near Orange

Devereaux John, flour packer, Granite mills, house 3 Favor
 Devereaux Nicholas B. (*O'Connor & Devereaux*), house 19 Lyell
 Devereaux Thomas, packer, Ely Mills, bds. Favor n. West avenue [n. Cottage
 Deverell Elizabeth, widow, house Genesee
 Devine Ann, widow, house 19 Romeyn
 Devine Charles, teamster, b. 143 Pinnacle av.
 Devine John, laborer, house St. Joseph near Hayward park [43 Bartlett
 Devine Joseph H. teamster, 53 E. Main, house
 Devins James G. butcher, house 188 Pinnacle avenue
 Devins Oliver, carpenter, h. 143 Pinnacle av.
 De Visser Caroline, widow, h. 10 Clarkson
 De Visser Henry J. chairmaker, lower falls, house Clarkson near Champion
 De Visser Jacob, deceased June, 1875
 De Visser John, sawyer, lower falls, house 10 Clarkson
 De Visser Marinus J. laborer, N. Y. C. depot, house 16 Clifford
 Devitt Hugh, saloon, Exchange cor. Spring, house 74 Adams cor. Ford
 Devitt Thomas E. shoemaker, River near N. Water, house 52 Sellinger
 Devlin Edward, hackman, 15 Fitzhugh, h. 58 Reynolds
 Devlin Susan, dressmaker, h. 58 Reynolds
 Devlin William J. removed to Ohio
 DeVoe Daniel, conductor, N. Y. C. R. R. h. 198 North
 Devoe Joseph, house 12 Woodbury
 De Voll A. P. insurance, 33 Arcade, house 1 Tracy park [113 N. St. Paul
 Devos Abraham, provision dealer, 48 Front, h.
DEVOS JACOB, pork packer and provision dealer, 44 Front, house 37 Chatham.—
See page 551
 Dewel Edward, teamster, boards 9 S. Ford
 Dewer William, cabinetmaker, Jay cor. Erie canal, house 51 Baden
 Dewey Ann, widow, h. 279 North St. Paul
 Dewey Caroline Mrs. boarding house, 11 Centre park, house do.
 Dewey Chas. D. vice pres. Johnston Harvester Co. boards Congress Hall
 Dewey Chester Mrs. widow, house 48 Spring
DEWEY DELLON M. art gallery and fruit plates, 8 Arcade, house 36 East avenue.—
See page 523
 Dewey Frederick W. house 262 N. St. Paul
 Dewey Isaac H. (*Burley & Dewey*), 88 State, boards 262 North St. Paul
 Dewey Samuel B. house 10 Fitzhugh
 Dewey Samuel B. house 3 Vine
 Dewing Vincent, salesman, 73 E. Main, bds. 119½ do. [100 Kelly
 DeWitt Bastian, paper maker, paper mill, b.
 DeWitt Charles, painter, house 16 Kirk
 DeWitt Charles S. coachman, 6 Livingston place, boards do. [do.
 DeWitt Clarissa, dressmaker, 36 S. Ford, h.
 DeWitt David W. deceased
 DeWitt Homer S. driver, boards 36 S. Ford
 DeWitt Isaac, laborer, house 25 Goodman
 DeWitt Orpha A. widow, h. 20 Champlain

DeWitt Peter, painter, 184 State, house rear Hayward park, near St. Joseph
 DeWitt William H. policeman, City Hall, h. 11 Waverley place [Exchange
 Dexter J. laborer, 178 Plymouth av. bds. 217
 Dexter Wm. H. student, University of Rochester, bds. 121½ East Main
 Dey Charles, bookkeeper, 73 East Main, bds. 170½ West Main [West Main
 Dey George, clerk, 73 East Main, bds. 170½
 Dey Robert, clerk, 73 East Main, bds. 170½ West Main [1 Rowley
 Deyo Anna E. Miss, dressmaker, boards
 Deyo Charity, widow, house 1 Rowley
 Deyo Ellen M. sewer, boards 42 Manhattan
 Deyo George H. removed from city
 Deyo Jeremiah M. carpenter, 3 Maple place, house do.
 Deyo Kate Miss, dressmaker, bds. 1 Rowley
 Deyo Theodore W. agent, house 7 Jones av.
 Deyoe Albert, gardener, house 24 Tyler
 Deyoe Eliza, widow, house 38 Brown's blk.
 Deyoe George, boatman, bds. 38 Brown's blk.
 DeYough Jacob S. packer, house 8 Shamrock
 DeYoung Andrew M. brakeman, N. Y. C. R. R. boards 34 George
 DeYoung Julia I. dressmaker, b. 34 George
 DeYoung Louis, hack driver, 47 S. St. Paul, boards 34 George
 DeYoung Samuel M. painter, h. 64 Andrews
 Diamond Addison H. boxmaker, ft. Centre, boards 303 State
 Diamond James, carriagemaker, h. 303 State
 Dibble Carrie E. widow, h. 66 University av.
 Dibble Charles E. laborer, house 74 West
 Dibble Merton C. salesman, 73 East Main, boards 169 do.
DIBBLE SIDNEY W. & DUTTON (*Marvin O. Dutton*), Wheeler & Wilson sewing machines, 20 E. Main, h. at New York.—
See page 538
 Dichter Frederick, mason, house 73 Reynolds
 Dick James, mason, house 17 Charlotte
 Dick Joseph A. mason, boards 17 Charlotte
 Dick Peter, foreman, 3 Elizabeth, h. 4 College
 Dickas Adam, laborer, house 57 Reynolds
 Dickens Maria, widow, boards 66 Oak
 Dickey David, agent, Seamen's Friend Society, house 3 Centre park [North av.
 Dickinson Alfred L. farmer, house Norton n.
 Dickinson Alfred B. blacksmith, boards 4 Trowbridge [Paul
 Dickinson Alzina A. widow, h. 140 N. St.
 Dickinson Charles, boards 29 Chestnut
 Dickinson Charles A. farmer, bds. Norton near North avenue [78 Clifton
 Dickinson Edward H. morocco, 47 Mill, h.
 Dickinson Henrietta, widow, h. 49½ Hamilton place [bds. 10 Marietta
 Dickinson Henry B. clerk, 16 East Main,
 Dickinson Ira B. fireman, boards 12 Gorham
 Dickinson James M. engineer, h. 10 Marietta
 Dickinson Joanna H. Miss, teacher, Concord school No. 18, bds. 49½ Hamilton place
 Dickinson Lemuel, clerk, b. 49½ Hamilton pl.
 Dickinson Levi, surveyor, bds. Norton near North avenue
 Dickinson Marita, stitcher, bds. 12 Gorham

Dickinson Oliver P. farmer, boards Norton near North avenue
 Dickinson Phebe W. widow, h. 12 Gorham
 Dickinson Pomeroy P. (*Benton & Dickinson*), 84 Arcade, house Norton cor. North av.
 Dickinson Rowland H. deceased, March, 1876
 Dickinson Samuel G. machinist, Brown cor. Jones, house 34 Saratoga avenue
 Dickinson Sidney G. augermaker, p. 20 Mark
DICKINSON WILLIAM C. agent, Delaware & Hudson Canal Co. 52 W. Main, Powers' buildings, Clarissa corner Exchange, and Lake av. cor. Lyell, h. 54 Park avenue.—*See page 600*
 Dickinson William L. student, University of Rochester, boards 19 Ward
 Dickson John, carpenter, b. 93 Plymouth av.
 Dickson Margaret J. teacher, Tremont school No. 3, boards 80 Plymouth avenue
 Dickson Sarah A. house 47 Lake avenue
 Dickson William F. dentist, bds. 21 Troup
 Didrich John, butcher, boards 56 Franklin
 Diebel Christopher, deceased, December, 1875
 Diebel Conrad, saloon, 9 S. St. Paul, h. do.
 Diefendorf Byron J. salesman, 100 State, b. Brackett House
 Diehl George, laborer, house 93 Chatham
 Diehl Jacob, tucker, house 54 Lime
 Diehl John, mason, h. Hollenbeck n. North Clinton
 Diehl Mary, widow, bds. 47 Childs near Jay
 Diehm Christiana, widow, house 11 German
 Diehm Emma, seamstress, boards 11 German
 Diel John, upholsterer, 184 State, bds. 44 N. Frances
 Diel Valentine, laborer, house 44 N. Frances
 Diem Christopher, toolmaker, 136 Mill, h. 10 Thomas
 Diem C. Charles, salesman, 136 Mill, bds. 10
 Diem Frederick S. well driller, house Lewis cor. Diem
 Diem Jacob, laborer, house 45 Gregory
 Diem John, carpenter, b. Flint n. Plymouth avenue [Hollister
 Diem Louis, currier, 51 North Water, h. 58
 Diemer Michael, gardener, Children's Home, 263 North St. Paul, boards do.
 Dies Amarilla Miss, boards 2 Joslyn park
 Dies George W. clerk, 11 S. St. Paul, house 33 Stone [Pomeroy
 Dies John, cooper, house West Maple cor.
 Dies Kittie A. dressmaker, house 42 Andrews
 Dies Nicholas, wire worker, boards West Maple c. Pomeroy [boards do.
 Diestler John J. butcher, 56 South St. Paul,
 Dieter Lovina Miss, boards 31 Asylum
 Dieterle Charles, tailor, house Alphonse near Hudson [Hamilton place
 Dietrich Elias, carriage maker, 3 Canal, h. 48
 Dietrich Frank, shoemaker, bds. Hague near West Maple [Maple
 Dietrich Gertrude, widow, h. Hague n. West
 Dietrich Johanna, widow, house 363 Brown
 Dietrich John, cigar maker, house 34 Joiner
 Dietrich John, laborer, h. West Maple near Hague [West Maple
 Dietrich John, moulder, 187 W. Main, h. 37
 Dietrich John jr. deceased May 26, 1875

Dietrich Joseph, removed to Chicago
 Dietrich Peter, salesman, Exchange n. Troup, house 5 Whitney [near Bay
 Dietrich Theodore, blacksmith, h. First av.
 Dietrick Frank P. shoemaker, 350 Brown, boards do. [house do.
 Dietrick George, shoemaker, 350 Brown,
 Dietz Frank, varnisher, 15 N. Water, house 321 North Clinton
 Dietz Henry (*Dietz & Dusch*), pump maker, 309 North Clinton, house 308 do.
 Dietz John, shoemaker, house 20 Thomas
 Dietz Theofield, tailor, house 54 Baden
 Dietz & Dusch (*H. Dietz and J. Dusch*), pump manufs. 309 North Clinton
 Dignam James, laborer, 90 S. St. Paul, house Pinnacle avenue near Field
 Dignin Henry J. boards 19 Jones
 Dignin Julia, dressmaker, boards 71 Lake av.
 Dike Ada M. Miss, house 18 Atkinson
 Dikeman Mary S. widow, house 34 Tappan
 Dildine Clark C. clerk, 6 Exchange, boards 10 Sophia
 Dilg Peter, laborer, boards 63 Martin
 Dilg William, tailor, 40 E. Main, house 13 Emmett
 Dilger Wilbert, optician, 179 N. St. Paul, b. 96 St. Joseph
 Dill Adam, cabinet maker, house 31 Saxton
 Dill Charles, blacksmith, 100 S. St. Paul, h. 273 St. Joseph
 Dill Frank, house 91 North Clinton
 Dill Frank J. marble cutter, 122 S. St. Paul, house 273 St. Joseph [Clinton
 Dill Joseph P. painter, 3 Canal, bds. 91 N.
 Dill Leonard W. coach trimmer, house 436 Brown
 Dillman Christian, stone cutter, 54 Fitzhugh, house 45 Hanover
 Dillman Christopher, boards 23 Baden
 Dillon Andrew, laborer, house 10 Julia
 Dillon Jane Mrs. house 13 Lancaster
 Dillon Sarah, clerk, boards 13 Lancaster
 Dillon Thomas, clerk, 251 East Main, boards E. Main n. North
 Dimpfel John, carriage trimmer, 3 Canal, h. Orchard c. Campbell
 Dinan James, laborer, boards 2 Centre
 Dinan John, laborer, boards 2 Centre
 Dinan Michael, blacksmith, house 154 Scio
 Dinan Thomas, laborer, boards 2 Centre
 Dinan Thomas B. coach maker, 3 Canal, b. 80 West avenue
 Dinehart Wm. H. news agent, 103 Mill
 Dingman Abner, cartman, house 89 Clifton
 Dingman Charles, agent, house 9 Prospect
 Dingman Dora C. widow, house 9 Prospect
 Dingman Hattie, stitcher, house 14 Prospect
 Dingman Mary, widow, house 9 Prospect
 Dingman Nellie, stitcher, house 14 Prospect
 Dinklespiel Abraham, 46 Mill, h. 90 Atwater
DIRECTORY OFFICE, 114 Powers' buildings.—*See front colored page*
 Dirringer Wm. mason, h. Goodman n. Bay
 Disbrow Harriet A. house 64 East avenue
DISBROW IRA S. box manufacturer, 3 Aqueduct, house 123 West avenue.—*See page 630*

DISBROW MYRON H. advertising agent, 29 W. Main, house 32 Monroe av.—*See back cover*
 Disbrow Sanford, house 64 East avenue
 Dischbein Michael, cooper, house 73 Kelly
 Dissett Edward M. laborer, State c. Centre, boards 43 Tremont
 Dissett Thomas, ship carpenter, h. 43 Tremont
 Dissett Thomas N. expressman, house 43 Tremont [34 King
 Ditner Alois, boots and shoes, 270 State, h.
 Ditner John T. trunkmaker, 78 State, house 119 Wilder [near Jay
 Dittenhafer George, laborer, h. Wackerman
 Dittey Henry, house 4 Fœhner
 Dittman Philip, cooper, 12 Martin, house do.
 Dittmar Alex. mason, house 16 Maria
 Dittmeier John, watches, &c. 143 E. Main, house 10 Asylum
 Dittmier Emma, boards 13 Asylum
 Diver James, salesman, East av. n. Goodman
 Divine Edwin H. removed to Utica
 Dix Frank A. salesman, b. 135 West avenue
 Dix Samuel, real estate, house 135 West av.
 Dixon Aaron H. removed to Auburn
 Dixon Benj. L. car coupler, N. Y. C. R. R. house rear 14 Allen
 Dixon Charles, laborer, boards 92 Front
 Dixon Daniel, house Clifton near Genesee
 Dixon Frank, cabinetmaker, 88 State, boards 126 Fitzhugh
 Dixon Henry, teamster, house 14 Fulton av.
 Dixon Richard B. carrier, post office, house 96 Reynolds
 Dixon William, house 66 Sophia
 Dixon William J. carpenter, h. 25 Edmonds
 Doane Clarissa, widow, boards 90 Tremont
 Doane Edmund M. (*W. A. Doane & Co.*) h. 34 Caledonia avenue
 Doane Emily C. widow, bds. 34 Caledonia av.
 Doane Garrett, shoemaker, 15 Mill, house 109 Atkinson [30 Lancaster
 Doane George V. shoemaker, 15 Mill, boards
 Doane Rolin C. agent, bds. 34 Caledonia av.
 Doane Willard A. & Co. (*E. M. Doane*), millinery, 45 E. Main, boards 22 Stillson
 Dobbertin Albert, broom maker, S. St. Paul corner Court, boards 62 Pearl
 Dobbertin Charles, broom maker, Court cor. S. St. Paul, boards 62 Pearl
 Dobbertin John, laborer, house 62 Pearl
 Dobbins Samuel L. bookkeeper, Atwater cor. N. St. Paul, house 45 Franklin
 Dobbs Merritt, laborer, 205 E. Main, boards 24 Stillson
 Dobbs Seneca, engineer, steamer No. 2, and (*Whitbeck & Dobbs*), boards 24 Stillson
 Dobbs Zachariah, house 24 Stillson
 Dobles Walter, shipping clerk, Washington Mills, boards 82 Lake avenue [Clifford
 Dobs Frederick, laborer, house Thomas near
 Dobson Anna Eliza Mrs. house University av. near Culver [Frances
 Dobson Bell Miss, boards New York near
 Dobson George, caulker, house 4 Spencer
 Dobson Isaac J. shoemaker, 160 East Main, house do. [Hudson
 Dobson Sarah J. dressmaker, boards 11

Dockray Joseph, removed from city
 Dockstader George W. blacksmith, 8 Centre, boards 80 Frank [80 Frank
 Dockstader Wm. (*Dockstader & Redding*), h.
 Dockstader & Redding (*W. Dockstader and D. W. Redding*), blacksmiths, 8 Centre
 Dodd Thomas, brewer, boards 302 State
 Dodds Cornelius L. polisher, 122 Mill, house 26 Bolivar
 Dodds Florence E. hairdresser, b. 26 Bolivar
 Dodds George E. plumber, boards 26 Bolivar
 Dodge Arnold A. mason, h. 52 Monroe av.
 Dodge Charles A. mason, house 30 Lancaster
 Dodge Charles A. clerk, 136 State, boards 22 Arnold park [near Caroline
 Dodge Henry, baker, house Mt. Vernon av.
 Dodge Lorenzo D. house 22 Elm
 Dodge Loudon U. (*Dodge & Boyd*), house 23 Upton park
DODGE & BOYD (*L. U. Dodge and J. A. Boyd*), lithographers and copper plate engravers, 12 East Main.—*See opp. page 640*
 Dodson Ellis A. bookkeeper, bds. 102 Plymouth avenue
 Dodson Henry H. car driver, boards 16 Spring
 Dodson Silas, house 102 Plymouth avenue
 Doehne William, tailor, 54 Smith's block, house 23 Tappan [Orchard cor. Smith
 Doell Heinrich, butcher, 144 Brown, house
 Doell John, market, 115 Mt. Hope av. b. do.
 Doell John jr. laborer, b. 115 Mt. Hope av.
 Doell J. Henry, market, 144 Brown, h. do.
 Doering John, planer, Jay cor. Erie Canal, house 48 Sanford
 Doerner George, teamster, 13 Warehouse, boards rear Lyell road near toll gate
 Doerr John, cabinetmaker, h. 23 Emmett
 Doerr Philip, laborer, house North avenue corner Stewart
 Doerr Florian, baker, house 30 Thomas
 Doerrer Joseph, marble polisher, 122 S. St. Paul, house 28 Thomas
 Doherty Ann, widow, boards 1 Edmonds
 Doherty Bridget, widow, house 128 Fulton avenue [Reynolds cor. Adams
 Doherty James, shoemaker, 87 E. Main, h.
 Doig George, tanner, house 9 Manhattan
 Dolan Bella, boards 7 Kirk
 Dolan Eliza Miss, boards r. 35 St. Joseph
 Dolan Frank, laborer, house 17 Davis
 Dolan John, removed to Byron [Main
 Dolan John W. coremaker, house 106½ West
 Dolan Martin, laborer, house 29 Saxton
 Dolan Mary, widow, h. r. 35 St. Joseph
 Dolan Mary, boards 17 Davis
 Dolan Mary A. widow, house 66 Bolivar
 Dolan Patrick, moulder, Brown's race near Furnace, house 19 Spencer
 Dolan William, laborer, house 93 Hunter
 Dolan Wm. M. clerk, 73 E. Main, b. 196 do.
 Dolanty Matthew, lunch house, 36 Mill, house do.
 Dolbeir Albert, carpenter, 3 Aqueduct, h. Scramton cor. Conkey avenue
 Dolbeir Elizabeth, widow, house 5 Martin
 Dolbeir George, photographer, 96 State, h. rear 139 Monroe avenue
 Dold Thomas, laborer, house 14 Bartlett

- Dole Joseph, pastor Our Lady of Victory's church, h. Pleasant near N. St. Paul
 Dollase Mary, widow, boards 19 Scrantom
 Dolley Charles S. student, boards 30 East av.
 Dolley Sarah R. A. (*Dolley & Searing*), 30 East avenue, house do.
 Dolley & Searing (*Mrs. Sarah R. A. Dolley and Miss Anna H. Searing*), physicians, 30 East avenue [house do.
 Dollinger August C. baker, 78 Chatham,
 Dolphin Mathew F. removed from city
 Dolson John W. F. house rear 20 $\frac{1}{2}$ Stone
 Dolt Jacob, laborer, 178 Plymouth av. h. 14 Bartlett
 Domatilla Sister, teacher, bds. Jay c. Frank
 Donahue Frank, currier, house 128 Caledonia avenue [Rochester, bds. 51 Chestnut
 Donahue George H. student, University of
 Donaldson Andrew, fireman, N. Y. C. R. R. house 3 Woodbury
 Donaldson Frank H. boards 31 Hamilton pl.
 Donaldson George A. fireman, N. Y. C. R. R. house 206 North [Hamilton place
 Donaldson Henry B. forwarder, house 31
 Donaldson John, hackman, 6 Lancaster, house 25 do. [boards do.
 Donaldson Margaret, nurse, House of Refuge,
 Donaldson Mary, dressmaker, 84 State, h. do.
 Donaldson Peter, saloon, 34 West av. h. do.
 Donaldson Watson H. laborer, house 25 Kirk
 Donaldson William, engineer, h. 39 Jones av.
 Doni Joseph, butcher, h. 29 Mt. Hope avenue
 Donigan Anthony, laborer, house 51 Lyell
 Donivan Cornelius, turner, b. 50 Munger
 Donivan John, grocer, 34 South St. Paul, h. 38 South avenue [b. 38 South av.
 Donivan Lewis J. clerk, 34 South St. Paul,
 Donivan Wm. S. clerk, 34 South St. Paul, boards 38 South avenue
 Donlon John, laborer, b. Sibley n. Culver
 Donlon Patrick, laborer, h. Sibley n. Culver
 Donnelly Anna, domestic, boards 18 Spencer
 Donnelly Charles C. deceased 1875
 Donnelly Edward (*S. Dunn & Co.*), 40 Mumford, house 73 Caledonia avenue
 Donnelly Elizabeth, domestic, boards 10 Scio
 Donnelly George W. clerk, gas works, house 26 North Union
 Donnelly James, carman, house 46 Howell
 Donnelly John, shoemaker, house 78 Lyell
 Donnelly Lizzie, widow, boards 4 Romeyn
 Donnelly Michael, hostler, State cor. Centre, house 13 Kent [65 Frank
 Donnelly Samuel, grocer, 168 State, house
 Donnelly Sylvester C. conductor, N. Y. C. R. R. house 45 Charlotte
 Donner Daniel, laborer, house 5 Kondolf
 Donner John, moulder, 20 Court, house W. Maple near Orchard
 Donner Joseph, laborer, house 321 Brown
 Donner Theresa, pasteur, boards W. Maple near Orchard [11 Rauber
 Donni August, screwmaker, 123 Mill, boards
 Donni Reinhardt, laborer, house 11 Rauber
 Donnington Lucy, widow, bds. 68 South av.
 Donoghue Catharine Miss, dressmaker, bds. 60 Reynolds
 Donoghue Daniel, boards 60 Reynolds
 Donoghue James, tinsmith, 11 Monroe av. house 52 Munger
 Donoghue Joseph M. boards 12 Chestnut pk.
 Donoghue Mary, widow, h. 12 Chestnut pk.
 Donoghue Timothy, farmer, h. 60 Reynolds
 Donoghue Timothy, boards 12 Chestnut pk.
 Donoghue William, removed to Virginia City, Nevada
 Donohue Bridget, widow, h. 54 Brown blk.
 Donohue Bridget, widow, house 23 Lime
 Donovan Bridget, widow, boards 10 Cliff
 Donovan Catharine, widow, h. 50 Munger
 Donovan Catharine, dressmaker, boards 25 Hand [Caledonia avenue
 Donovan Cornelius, cigar manufacturer, 9
 Donovan David, laborer, house 230 State
 Donovan Daniel, laborer, h. Sherman n. Otis
 Donovan Dennis, removed to Toronto, Ont.
 Donovan Ellen Miss, tailoress, boards 157 St. Joseph
 Donovan James, clerk, boards 157 St. Joseph
 Donovan John, dresser, 55 S. St. Paul, bds. 2 Green
 Donovan Margaret, widow, bds. 21 West
 Donovan Michael, marble polisher. 122 S. St. Paul, house 2 Green
 Donovan Paul, laborer, boards 25 Hand
 Donovan Thomas, saloon, 97 S. St. Paul, house do.
 Donovan Timothy, laborer, h. 157 St. Joseph
 Donovan Timothy jr. frame-maker, boards 157 St. Joseph [N. Y. C. R. R.
 Donovan Thomas, laborer, house Murray n.
 Donovan William J. clerk, 116 State, boards 24 Centre
 Donovan William, laborer, h. Lyell n. R. R.
 Donovan see Donivan and Dunnivan
 Donsbach Anthony, bricklayer, h. 44 Madison
 Donsbach Joseph, mason, house 436 Brown
 Doody Ann, widow, house Childs n. Maple
 Doody Michael, teamster, house 292 State
 Doody Peter, laborer, house 40 Cameron
 Doody Stephen, cigarmaker, 178 W. Main, boards Childs near W. Maple
 Doody Thomas, maltster, Mill cor. Factory, boards 302 State
 Doody William, carpenter, 55 Fitzhugh, house 45 S. Washington [Y. C. R. R.
 Doolin John, laborer, house Childs n. N.
 Doolin John, boilermaker, Platt, h. 3 Romeyn
 Doolin Michael, carpenter, b. Childs n. R. R.
 Doolin Thomas, shoemaker, 73 N. Water, house North Union near railroad
 Doolittle Filiofeete, widow, house 15 Gibbs
 Doolittle Mary A. Miss, music teacher, bds. 15 Gibbs
 Dopkins Norman W. clerk, E. Main, corner North avenue, house 133 Alexander
 Dopler Lydia M. tailoress, 58 Smith's block, boards 19 Gibbs
 Doran Ann, widow, house Magne n. Lyell
 Doran Edward, laborer, boards 39 Thompson
 Doran Edward M. grocer, 110 Caledonia av. house 12 Seward
 Doran Ellen, widow, boards 17 Almira
 Doran John, cabinetmaker, h. 32 Gregory
 Doran Mary ass't. forewoman, boards 39 Thompson

HENRY C. WISNER,

CUT AND PRESSED GLASS TABLE WARE,
No. 33 STATE STREET.

- Doran William, carpenter, h. 39 Thompson
 Doran William, teamster, house 18 Almira
 Doran William, sawyer, b. Magne n. Lyell
 Dorfer Catharine, widow, house 35 Vienna
 Dorfer George A. laborer, house 35 Vienna
 Doris Emma, teacher, boards 62 West av.
 Doris Sarah, widow, house 62 West avenue
 Dorrler John, teamster, boards 32 Franklin
 Dorn John, cabinetmaker, 117 N. Water, h. 65 West Maple
 Dorntee George W. clerk, Exchange corner Court, boards 3 South
 Dorphey Joseph, upholsterer, h. 70 Chestnut
 Dorr Cornelius, removed to Syracuse
 Dorr see Doerr
 Dorrer Charles, cigarmaker, b. 150 St. Joseph
 Dorrer Eberhard, porter, River c. N. Water, house 3 Moore
 Dorrer Genofeva, widow, h. 150 St. Joseph
 Dorrer Mary, rubber shoemaker, b. 3 Moore
 Dorrigan Mary, widow, h. Brown c. Frank
 Dorsch John, cabinet maker, house 31 Kelly
 Dorschel Barbara Mrs. house 82 Chatham
 Dorschell Frederick, cutter, bds. 36 Nassau
 Dorschell John, axle maker, 141 N. Water, boards 36 Nassau
 Dorschell John, carpenter, b. 126 Hudson
 Dorschell Joseph H. carver, Hydraulic bldgs. b. 36 Nassau
 Dorschell Pastor, blacksmith, River corner N. Water, house 36 Nassau
 Dorschell Roman, printer, bds. 86 Chatham
 Dorschell Roman, carpenter, 126 Hudson, house do.
 Dorsey Annie, stitcher, boards 5½ Granger
 Dorsey Edward, clerk, h. 120 Lake avenue
 Dorsey Hugh, miller, house 8 Spencer
 Dorsey James (*Dougherty & Dorsey*), Mill c. Platt, house 14 Greig
 Dorsey Julius, trussmaker, boards 105 Mill
 Dorsey Margaret Miss, house 123 Scio
 Dorsey Mary, domestic, 29 Lake avenue
 Dorsey Patrick, laborer, h. 127 S. St. Paul
 Dorsey Patrick, student, University of Roch. boards 60 Court [Scotland
 Dorward William, removed to Arbroath,
 Doser Adam, laborer, bds. Monroe av. near toll gate
 Doser Bartholomay, shoemaker, 79 N. Water, house Hoelfer near North Clinton
 Doser Christian, gardener, house Norton near North Clinton
 Doser John A. shoemaker, 73 N. Water, h. Flower near N. Clinton [tollgate
 Doser Joseph, laborer, h. Monroe av. near
 Doser Louis, glue maker, Erie canal wide water, house Monroe av. n. tollgate
 Doser Matthias, shoemaker, 74 N. Water, b. Norton near N. Clinton
 Doske Charles, laborer, house 16 Holland
 Dossenbach Matthias, teacher, house 17 Vose
 Doty Clara E. teacher, boards 116 Frank
 Doty Edmund P. undertaker, 116 Front, house 116 Frank
 Doty Emily, widow, house 67 Tremont
 Doty Hiram, mason, house 8 Perkins
 Doty James H. removed from city
 Doty Mary E. Mrs. nurse, boards 81 Scio
 Doucett Edward, shoemaker, 91 N. Water, boards York House [44 Vienna
 Doucette Henry, shoemaker, 111 State, house
 Doud Ann, widow, house 13 Vincent place
 Doud Bernard S. morocco dresser, h. Smith corner Saxton
 Doud Edward O. 14 State, house at Brighton
 Doud Elizabeth Miss, boards Field near Monroe avenue [126 S. St. Paul
 Doud James E. engineer, Osburn House, h.
 Doud Louisa N. widow, house 41 Cypress
 Doud Margaret, widow, house Field near Monroe av.
 Doud Rosanna, widow, house 36 Brown's al.
 Doud Thomas, laborer, house 149 N. Union
 Dougherty Daniel D. cooper, b. 41 Thompson
 Dougherty Ella Rose, St. Mary's Hospital, West avenue cor. Genesee
 Dougherty Frank, deceased 1875
 Dougherty Henry D. photographer, 83 East Main [Munger
 Dougherty James, janitor, 35 State, house 20
 Dougherty James, shoemaker, 87 East Main, house Reynolds cor. Adams
 Dougherty John B. (*Dougherty & Dorsey*), h. 12 Smith
 Dougherty John F. removed from city
 Dougherty John J. pressman, b. 20 Munger
 Dougherty Martin, mason, house 39 Bolivar
 Dougherty Mary, widow, h. Lyell c. Whitney
 Dougherty Michael A. carpenter, boards 20 Munger
 Dougherty Owen, deceased Oct. 20, 1875
 Dougherty Thomas, teamster, Court street bridge, house 9 Bond
 Dougherty & Dorsey (*J. B. Dougherty and J. Dorsey*), machinists, Mill cor. Platt
 Douglas Franklin, 150 Powers' bldgs. b. 146½ West Main
 Douglas Sarah, widow, boards 36 Troup
 Douglas Sarah Miss, boards 84 North av.
 Douglas William B. house Grove place
 Douglass Curtis N. student, University of Rochester, boards 51 Chestnut
 Douglas Isaac, shoemaker, 54 State, house 72 North avenue
 Douglass Wm. H. peddler, b. 30 Lancaster
 Dove Thomas, shoemaker, 79 N. Water, h. 24 Gardiner park
 Dove William, foreman job rooms, 82 West Main, house 91 South avenue [State
 Dow Ephraim, deputy marshal, house 250
 Dow Frederick A. frame maker, 250 State, boards do.
 Dow Lewis C. clerk, 350 State, b. 250 do.
 Dow Ruby Mrs. dressmaker, 250 State, h. do.
 Dowd Bridget, domestic, h. Culver n. railroad
 Dowd Charles A. shoemaker, bds. 22 Trowbridge
 Dowd Clinton B. laborer, house 95 Kelly
 Dowd George, moulder, house 1 Child's al. near Erie Canal
 Dowd Jerome P. foreman, Babcock Fire Extinguisher, 61 Front, boards do.
 Dowd Peter, fireman, house 19 Montrose
 Dowd Sarah A. widow, house 22 Trowbridge
 Dowd see Doud
 Dowdell Henry, laborer, b. Sherman c. Otis

Dowdell James, laborer, house 70 Platt
 Dowden George H. carpenter, h. 6 Cameron
 Dowling Mary E. teacher, 76 Exchange, b.
 16 Elm [N. Water, b. 49 Nassau
 Dowling John W. shoemaker, Andrews cor.
 Dowling Lizzie, stitcher, b. 70½ Reynolds
 Dowling Patrick J. street superintendent, h.
 119 North St. Paul
 Downer Joseph G. real estate, bds. 59 Meigs
 Downey Catharine, domestic, bds. 149 Alex-
 ander
 Downey Daniel, laborer, house 5 Goodman
 Downey Daniel, laborer, house 16 South av.
 Downey Edward, entry clerk, 53 E. Main, b.
 9 Smith
 Downey John, moulder, house 9 Whitney
 Downey Joseph, machinist, Clinton Mills,
 boards 36 Kent [railroad
 Downey Josiah, engineer, house Childs cor.
 Downey Thomas, moulder, Brown's race, n.
 Furnace, house 7 Railroad alley
 Downing Amelia A. widow, house 82 Weld
 Downing Cornelius, laborer, h. r. 21 Monroe
 avenue [Erie canal
 Downing Edward, ice peddler, b. Rowe n.
 Downing John B. shoemaker, 15 Mill, bds.
 York House [corner Frances
 Downing Josephine E. nurse, house E. Maple
 Downing L. E. Fraser Mrs. house Tremont
 near Genesee Valley canal
 Downing Royce, miller, boards 82 Weld
 Downing Thomas, removed from city
 Downing Wm. H. flour packer, Whitney
 Mills, boards 13 Weld
 Downs Charlotte, widow, b. 108 Broadway
 Downs Matilda J. & Co. (T. H. Downs), laun-
 dry, 155 W. Main, house do.
 Downs Truman H. (M. J. Downs & Co.), h.
 155 West Main
 Dox Rutger, student, Rochester Theological
 Seminary, boards Trevor Hall
 Doxtater Chauncey, house 67 North Water
 Doxtater Chauncey B. & Bro. (G. A. Doxta-
 ter), bathing house, 67 N. Water, h. do.
 Doxtater George A. (C. B. Doxtater & Bro.),
 boards 67 North Water [Frank, b. do.
 Doxtater Harriet E. Miss, music teacher, 8
 Doxtater Thomas M. painter, 12 Stone, house
 5 Edmonds
 Doyle Bridget, laundress, house 14 Lowell
 Doyle Charles E. lamplighter, h. 72 West
 avenue [house 7 Walnut
 Doyle Daniel, oil agent, Platt corner Kent,
 Doyle Daniel W. clerk, 65 East Main, house
 50 Scio [boards do.
 Doyle E. Frank, clerk, 65 Caledonia avenue,
 Doyle Henry F. (Watters & Doyle), 17 Ware-
 house, house 21 Kent
 Doyle James, laborer, house 8 Stone
 Doyle James, moulder, 20 Court
 Doyle James, teamster, boards 17 Orchard
 Doyle James, switchman, house Fairmount
 near University avenue
 Doyle James, gardener, house Alexander c.
 Charlotte
 Doyle Jane Miss, house 112 University av.
 Doyle John, laborer, b. Mansion n. Canal
 Doyle John, laborer, house 110 Fulton av.

Doyle John, policeman, City Hall, house 17
 Ward
 Doyle John, clerk, 101 E. Main, h. 15 Fitzhugh
 Doyle John J. waiter, Osburn House, bds. do.
 Doyle Kate, clerk, boards 304 State
 Doyle Margaret, widow, house 15 Gorham
 Doyle Mary, milliner, boards 304 State
 Doyle Mary, widow, h. Mansion n. Canal
 Doyle Mary A. domestic, bds. 107 Lake av.
 Doyle Mary J. widow, boards 2 Bloss
 Doyle Mary R. widow, house 52 Reynolds
 Doyle Michael, laborer, house r. 65 Bolivar
 Doyle Owen, chair finisher, house 2 Emmett
 Doyle Patrick, laborer, Brown corner Jones,
 house 13 Walnut
 Doyle Patrick, mason, house 49 Smith
 Doyle Richard M. painter, b. 65 Caledonia av.
 Doyle Rosanna, grocer, 65 Caledonia avenue,
 house do.
 Doyle Stephen, lamplighter, b. 1 North York
 Doyle Thomas, switchman, bds. Fairmount
 near University avenue [b. 7 Walnut
 Doyle William A. laborer, Platt corner Kent,
 Doyle William B. blacksmith, h. 1 N. York
 Doyle William J. porter, Congress Hall b. do.
 Drager Henry, teamster, house Channing n.
 North
 Draime Wm. bookkeeper, bds. Nichols park
 Drake Agnes, widow, boards 205 State
 Drake Charles W. removed to New York
 Dransfield Richard, carpenter, house 81 Allen
 Dransfield Susan M. assistant librarian, Cen-
 tral Library, Free Academy building,
 boards 7 Clifton
 Dransfield Thomas (Bausch & Dransfield), 20
 Arcade, house 20 Spencer
 Draper Ann, widow, house 2 Union alley
 Draper Catharine, boards 115 Monroe avenue
 Draper Elizabeth (Houston & Draper), 3 El-
 wood block, boards 115 Monroe avenue
 Draper George P. lawyer, 36 Powers' bldgs.
 house Monroe avenue corner Averell
 Draper Henry S. patent medicine, h. 48 Meigs
 Draper Jerome, painter, h. 39 S. Washington
 Draper Jerry F. boxmaker, 3 Aqueduct, bds.
 39 South Washington
 Draude Augustin, cabinetmaker, 123 Mill, h.
 107 South av. [house do.
 Draude Elizabeth Mrs. grocer, 27 Orange,
 Draude George, cabinetmaker, 184 State, h.
 27 Orange
 Draude George, shoemaker, house 20 Terry
 Drechsler Frank, gardener, house 68 Ontario
 Drechsler Frank, shoemaker, 18 S. St. Paul,
 house 63 Weld
 Drechsler George, shoemaker, house 86 Weld
 Drechsler John, shoemaker, bds. 68 Ontario
 Drechsler Joseph, sawyer, boards 68 Ontario
 Drecoll Charles, shoemaker, 30 East Main, h.
 32 Thomas [near Orange
 Drees August, carver, 3 Canal, h. Walnut
 Drefahl Charles, tailor, house 61 Joiner
 Dreher Catharine, widow, house 67 Davis
 Dreher W. Adelin, deceased April, 1875
 Dreier Charles, mason, h. First av. near Bay
 Dreier Charles A. bootcrimper, 87 Front, h.
 13 Maria
 Dreier Ernst, laborer, house 7 Pryor

HENRY C. WISNER,

DECORATED CHINA, SILVER SETS,
 No. 33 STATE STREET,

- Dreier Frederick, laborer, house 10 Wilson
 Dreier Henry, mason, house 31 Baden
 Dreimueller Christopher, laborer, house 18 St. Joseph
 Dremel Joseph, brakeman, boards 35 Galusha
 Dremel Mary, widow, boards 35 Galusha
 Drennan Mary A. tacker, Mill c. Platt, bds. 135 Mill
 Dresbach Joseph A. clerk, 9 South St. Paul, boards 6 Lowell
 Dresser Maria, widow, house 26 Monroe av.
 Dreverman Frank, teamster, h. 183 Monroe av.
 Drew Albert, printer, 23 West Main, boards 40 Sanford
DREW, ALLIS & CO. (*C. C. Drew and G. S. Allis*), directory publishers, Directory Office, 114 Powers' buildings.—*See front colored page*
 Drew Bridget, widow, house 22 Romeyn
 Drew Bridget, stitcher, boards 22 Romeyn
 Drew Charles C. (*Drew, Allis & Co.*), 114 Powers' buildings, boards 32 S. Clinton
 Drew Charles S. removed to Detroit
 Drew John, lime burner, Olean n. Plymouth avenue, house do.
 Drew John, shoemaker, 87 N. Water, boards 22 Romeyn
 Drew John, removed from city
 Drew Margaret, domestic, 42 North St. Paul
 Drew Nelson, laborer, house 88 West avenue
 Drew Wm. N. teamster, 176 Plymouth av. house 86 West avenue
 Drexelius Joseph, removed from city
 Drexelius Peter, moulder, 8 Hill, house 43 Childs opp. Orange [W. Maple
 Drexler Joseph, tailor, 8 West Main, h. 47
 Dreyer John, well digger, house 132 Hudson
 Dreyer Nancy, tailoress, 149 St. Joseph, b. 132 Hudson
 Dreyer Pius, cigar maker, bds. 132 Hudson
 Dries John, cooper, Magne n. R. R. house W. Maple near city line
 Driffill William, cartman, house 10 Green
 Driscoll Abigail, widow, h. 137 Caledonia av.
 Driscoll Frances, tailoress, bds. 13 Bolivar
 Driscoll James, cigarmaker, 48 Exchange, house 27 West Troup
 Driscoll Jeremiah, mason, house 333 State
 Drixel Louis, grinder, 8 Hill, house 4 Terry
 Drosselmeier Ernst, laborer, house r. 72 West Maple
 Druker Isaac, peddler, house 28 St. Joseph
 Drumm Thomas Rev. principal St. Mark's school, Clover street at Brighton
 Drummond Daniel, civil engineer, house 15 Orchard
 Drummond William C. salesman, 42 East Main, bds. 24 Chestnut
 Drury Arthur, shoemaker, 83 N. Water, bds. 6 Martin [St. Paul
 Drury Marshall S. framemaker, h. 160 North
 Drury Michael, cigar maker, bds. 6 Martin
 Drury Peter, machinist, house 6 Martin
 Druse John, laborer, house 42 Sellinger
 Dryer Charles A. portraits, 171 Powers' buildings, boards 28 Court
 Dryer Christopher, laborer, b. 35 Oakman
 Dryer Henry, clerk, h. 147 Plymouth avenue
 Dryer Rufus K. bookkeeper, 3 Canal, boards Fitzhugh [North av. bds. do.
 Dubelbeiss Charles W. wire manuf. Bay c.
 Dubelbeiss Cornelia, milliner, 35 North av. boards Bay cor. Ulm
 Dubelbeiss Louise Mrs. widow, h. Bay c. Ulm
 Dubelbeiss Matthias, wine manufacturer, h. Bay near Hebard
 Dubelbeiss Samuel, deceased July 4, 1875
 Dubelbeiss Samuel, grocer, Bay cor. North avenue, house do.
 Dubelbeiss Samuel M. clerk, Bay cor. North avenue, bds. do.
 Dublin Frank A. carriagemaker, b. 86 Scio
 Duboc Clara H. teacher, b. 185 Alexander
 Duboc Henry A. clergyman, boards 185 Alexander
 Duboc Mary C. widow, house 185 Alexander
 Dubois Hudson, bookkeeper, house 162 Plymouth avenue [Stone, h. 50 Griffith
 Duddleston Hugh, watchmaker, Court corner
 Dudeney Eliza Mrs. boarding house, 35 Frank, house do. [35 Frank
 Dudeney Henry, miller, Central Mill, house
 Dudley Alfred W. removed to Albany
 Dudley James W. student, h. 35 Manhattan
 Dudley Lucian H. salesman, house Monroe avenue corner South Union
 Dudley M. E. seedpacker, b. 56 N. Union
 Duel Hiram, boatman, boards 54 West av.
 Duell Adam, cabinetmaker, 133 N. Water, house 31 Saxton [436 Brown
 Duell Leonard, carriage trimmer, 3 Canal, h.
 Duerbaum Detrich, cooper, Smith c. canal, house 64 Magne
 Duerr Adam, cigarmaker, bds. 77 Chatham
 Duerr Charles F. boilermaker, h. 77 Chatham
 Duerr Charles F. printer, 62 State, house 69 Chatham
 Duerr Delia, widow, b. Hollister n. Clifford
 Duerr Martin, boilermaker, house N. Clinton near Norton
 Duffett Annie Miss, boards 2 Jones avenue
 Duffett William H. superintendent, house 2 Jones avenue [Jones av.
 Duffett William H. jr. bookkeeper, boards 2
 Duffey Rosa, widow, house rear S. St. Paul, opposite Griffith
 Duffield George, painter, house 19 Delevan
 Duffield Harry S. actor, Rochester Opera House, boards Chapman House
 Duffield Jane E. Mrs. boards 31 Hudson
 Duffield William F. (*Osgoodby & Duffield*), 133 Powers' bldgs. boards 28 Spring
 Duffin Mary E. widow, bds. 109 N. St. Paul
 Duffus John, removed from city
 Duffy Bridget, house 35 Bolivar
 Duffy Bridget, widow, house 4 Tyler
 Duffy Catharine A. house 48 South avenue
 Duffy Charles J. framemoulder, 43 North, house 58 Cady [South av.
 Duffy Cornelius, grocer, 33 Alexander, h. 48
 Duffy Edward (*W. B. Duffy & Co.*), 8 White, house 78 Lake avenue [Hope av.
 Duffy Frances M. lacemaker, boards 99 Mt.
 Duffy Frank V. deceased Dec. 27, 1875
 Duffy John, carpenter, b. 229 Plymouth av.
 Duffy John, flagman, boards Centre c. Mill

Duffy John, switchman, house University av. near Upton park
 Duffy Joseph, clerk, boards 48 South av.
 Duffy Joseph, shoemaker, 111 State, boards 3 Amity [opp. Bowen
 Duffy Maggie, domestic, boards East avenue
 Duffy Mary, cook, 36 West Main, b. Otsego near Centre
 Duffy Mary, boards 15 Montrose
 Duffy Mary, shoemaker, boards 35 Bolivar
 Duffy Mary, widow, house 37 Goodman
 Duffy Mary Miss, boards 19 Marshall
 Duffy Mary, widow, house 99 Mt. Hope av.
 Duffy Mary A. tailor, b. 99 Mt. Hope av.
 Duffy Mary A. Miss, packer, b. 58 Reynolds
 Duffy Michael W. tobacconist, 23 W. Main, house 3 Vought
 Duffy Patrick A. carpenter, h. 44 Edinburgh
 Duffy Patrick M. painter, 10 Front, house 16 Catharine
 Duffy Rosa, vestmaker, b. 126 Fitzhugh
 Duffy Thomas, clerk, house 30 Alexander
 Duffy Thomas J. laborer, boards 35 Bolivar
 Duffy Thomas R. blacksmith, 150 Plymouth avenue, boards 55 Champlain
DUFFY WALTER B. & CO. (*Edward Duffy*), rectifiers, 10 White, house 29 Lake avenue.—*See page 594*
 Duffy William H. cutter, 64 Mill, house 37 McDonald avenue
DUFNER JOHN, last factory, Shawmut bldgs. Mill, h. 19 Gorham.—*See page 663*
 Dufner John jr. bookkeeper, Shawmut bldgs. Mill, boards 19 Gorham
 Dugan Alice, seamstress, boards 38 Allen
 Dugan Cornelius, watchman, 3 Canal, house 88 North Clinton
 Dugan Daniel, varnisher, boards 11 Lime
 Dugan Diana Mrs. house 11 Lime [Main
 Dugan John, foreman, 70 Mill, bds. 142½ W.
 Dugan John M. bartender, 96½ Front, b. do.
 Dugan John T. stonecutter, boards 11 Lime
 Dugan Mary E. Mrs. dressmaker, 95 North avenue, house do.
 Dugan Mary E. dressmaker, 11 Lime, b. do.
 Dugan Michael E. clerk, 280 State, boards 11 Lime
 Dugan Timothy, laborer, b. Frank c. Brown
 Duggan Richard, tailor, 1 S. Water, h. do.
 Duggan Robert, painter, 47 E. Main, h. Scio
 Duguid Alexander, salesman, 73 East Main, boards 170½ West Main
 Duhr Charles H. L. salesman, bds. 26 Front
 Duke Bridget, widow, house 18 Brown's al.
 Duke John, removed to St. Catharines, Ont.
 Duke Thos. removed to St. Catharines, Ont.
 Dukelow James, laborer, house 114 Hunter
 Dukelow Mary, widow, boards 44 Ontario
 Dukelow Peter, shoemaker, 55 Mill, h. 21½ Ontario
 Dukelow Richard, shoemaker, h. 12 Ontario
 Dukelow Thomas, carpenter, b. 12 Ontario
 Dukelow Thomas, policeman, City Hall, h. 44 Ontario
 Dulany William T. removed from city
 Duley Thomas, shoemaker, house N. Union near Lewis
 Dulohery Daniel, laborer, h. Walnut n. Smith

Dulohery Mary Miss, h. Walnut n. Smith
 Dulohery Michael, machinist, Brown corner Jones, house 24 Smith
DUMBLE ALBERT E. & CO. (*B. S. Mixer*), photographers, 44 State, h. 301 E. Main.—*See page 522*
 Dumerese Anna, widow, h. 138 St. Joseph
 Dumerese Frank, laborer, b. 138 St. Joseph
 Dumerese Gustav, laborer, h. 138 St. Joseph
 Dummer Adolph jr. blacksmith, house Hudson near Norton [n. Norton
 Dummer Adolph, laborer, house rear Hudson
 Dummer Charles, laborer, h. 18 Wadsworth
 Dummer Christian, grinder, h. 29 Wadsworth
 Dumond Alonzo M. tinsmith, house 49 Mt. Hope avenue [38 Broadway
 Dumond Frank I. plumber, 96 East Main, h.
 Dumond Julia M. widow, house 21 Sanford
 Du Mouchell L. A. musician, boards 144 West Main
DUN R. G. & CO. Mercantile Agency, 15 Exchange, house at New York city.—*See page 692*
 Dunbar Altany, widow, house 11 Kirk
 Duncan George W. foreman, h. 60 Frost av.
 Duncan Jane, widow, boards 45 Kirk
 Duncan John, laborer, house 78 Davis
 Duncan Susan Mrs. house 66 West Troup
 Duncan William A. artist, 173 Powers' bldgs. boards 22 Sophia
 Dunham David W. (*Dunham & Co.*), 117 North Water, boards 51 Chestnut
 Dunham Ralph, removed to Mt. Morris
DUNHAM & CO. (*D. W. Dunham and E. N. Adams*), chair manufs. 117 N. Water.—*See page 613*
 Dunklee James, agent, h. r. 126 Lake av.
 Dunlap Andrew, laborer, h. 34 Plymouth av.
 Dunlap Belinda E. Mrs. boards 60 Sophia
 Dunlap J. Boyd, dry goods, 87 Monroe av. house 24 Broadway
 Dunlap Martha Miss, house 54 East avenue
 Dunlap Mary Miss, house 54 East avenue
 Dunlap Nancy Miss, house 54 East avenue
 Dunlap William J. salesman, 13 East Main, h. 19 South avenue [Lancaster
 Dunlay Wm. laborer, 144 East Main, bds. 9
 Dunlevy John (*Dunlevy & Delavau*), boards 17 Olean [house 17 Olean
 Dunlevy Thomas, japanner, 150 N. Water,
DUNLEVY & DELAVAU (*J. Dunlevy and J. S. Delavau*), grocers, 28 Allen.—*See page 574*
 Dunn Agnes, widow, house 8 Jay
 Dunn Anastasia, house 29 Broadway
 Dunn Bernard, foreman, 55 South St. Paul, house 101 Meigs
 Dunn Bridget, widow, house 13 Mortimer
 Dunn Catharine, widow, house 43 Griffith
 Dunn Charles A. bookkeeper, h. 2 Mumford
 Dunn Christopher, peddler, 144 East Main
 Dunn Dennis, harnessmaker, 20 Market, bds. 56 Prospect
 Dunn Edward, boards 74 West avenue
 Dunn Elizabeth, widow, h. Adams c. Exchange
 Dunn Ella, domestic, boards 41 Marshall
 Dunn Frank P. removed to Syracuse
 Dunn Hannah, domestic, 119½ East Main

- Dunn Henry M. clerk, 17 S. St. Paul, h. 66
South avenue
- Dunn Isabelle, whipmaker, boards 8 Jay
- Dunn James, boards 15 Newton block
- Dunn James, carpenter, house 138 Saxton
- Dunn James, laborer, house 22 Grand
- Dunn John, farmer, h. Culver near Webster
road
- Dunn John, plumber, boards 29 Broadway
- Dunn John, boards 74 West avenue
- Dunn John, clerk, boards 19 Lawrence
- Dunn John M. boilermaker, 138 Mill, h. 7
Cliff
- Dunn John W. machinist, house 58 Chatham
- Dunn Jonathan, salesman, 73 E. Main, bds.
14 Elm
- Dunn Kieran, wiper, house 64 Hunter
- Dunn Maggie I. tailorress, boards 22 Grand
- Dunn Margaret, widow, h. 17 Mt. Hope av.
- Dunn Martha M. b. East av. c. Alexander
- Dunn Mary, weaver, boards 8 Jay
- Dunn Mary, stitcher, boards 169 East Main
- Dunn Mary, widow, house 7 Magne
- Dunn Michael, engineer, 55 S. St. Paul, h.
8 Caroline [house do.]
- Dunn Nellie M. dressmaker, 4 Newton blk.
- Dunn Patrick, mason, house 56 Prospect
- Dunn Patrick jr. (*Hahn & Dunn*), 179 East
Main, boards 56 Prospect
- Dunn Rosa, laundress, boards 13 Mortimer
- Dunn Samuel & Co. (*E. Donnelly*), dyers, 40
Mumford, house 42 Sophia
- Dunn Sarah, widow, house 28 Trowbridge
- Dunn Susan Miss, boards 47 Mt. Hope av.
- Dunn Thomas, farmer, b. Culver near Web-
ster road [house. 21 South Ford
- Dunn Thomas, blacksmith, b. No. 4 Engine
- Dunn Thomas B. bleacher, 38 Mumford, b.
42 Sophia
- Dunne Ellen, widow, house 52 Griffith
- Dunne John, plumber, boards 29 Broadway
- Dunne Michael, tinsmith, boards 52 Griffith
- Dunne Patrick, machinist, 100 S. St. Paul,
boards 52 Griffith
- Dunne William, packer, house 36 Weld
- Dunnigan John, fireman, boards 1 Tyler
- Dunnihan Rosa, widow, b. 128 Lake avenue
- Dunning Eliza, removed to Lafayette, Ind.
- Dunning Eugene H. boards 20 Emerson
- Dunning Hiram, carpenter, house College
corner Briggs place
- Dunning John M. lawyer, 85 Powers' bldgs.
house 13 Briggs' place
- Dunning Katherine E. widow, h. 119 Saxton
- Dunnivan Daniel, laborer, h. r. 20 Griffith
- Dunnivan Timothy, laborer, h. 15 Thompson
- Dunphy Michael, laborer, 65 N. Water, h.
62 Hollister [h. 57 Atkinson
- Dunsee Cornelius E. photographer, 14 State,
- Duplenty Joseph, cooper, 30 Canal, boards
8 Kondolf
- Dupree Cornelius, removed to Patterson
- Dupree Nellie, boards Hudson corner Vose
- Durand Charles, planemaker, 136 Mill, house
54 Prospect
- Durand Eugene, coachman, h. 6 Tracy park
- Durand Fred. B. bookkeeper, 25 State, bds.
12 Centre park
- Durand Frederick L. lawyer, 54 Powers'
bldgs. h. 12 Centre pk.
- Durand Martha R. widow, house 8 Rome
- Durand Robert, driver, 38 Fitzhugh, house
34 Plymouth avenue
- Durfee Addison W. house 25 South avenue
- Durfee Andrew J. machinist, Brown corner
Jones, house 28 Bolivar
- Durgin Dearborn B. agent, h. 13 Evergreen
- Durgin Henry J. foreman, Jay corner Erie
Canal, house 60 Jay
- Durham Robert, carriage trimmer, 3 Canal,
house 53 Prospect
- Durham Stephen, saw maker, h. 147 Brown
- Durkin James H. shoecutter, 4 Allen, boards
118 Frank [house 118 Frank
- Durkin John, watchman, Kent cor. Platt,
- Durkin John, hairdresser, bds. 6 Thompson
- Durkin Kate Mrs. house 24 Smith
- Durkin Michael, laborer, house 6 Thompson
- Durkin William H. clerk, State c. Centre,
boards 118 Frank
- Durks Wm. blacksmith, house 103 Scio
- Durney Adeline L. widow, h. 19 Ambrose
- Durney Oscar F. clerk, boards 19 Ambrose
- Durney William A. machinist, Brown corner
Jones, house 90 Frank
- Durney William W. architect, b. 90 Frank
- Durnherr Annie, milliner, boards 81 Lyell
- Durnherr Emanuel, baker, 81 Lyell, h. do.
- Du Ross James, laborer, boards 14 Ward
- Durrinberger Margaret, widow, h. Ackerman
near Bay [park
- Duryee Chauncey A. teamster, h. 34 Oakland
- Duryee Chauncey Mrs. widow, bds. 5 Julia
- Duryee Ella H. Miss, teacher, Riley School
No. 14, boards 92 North avenue
- Duryee Harriet D. widow, h. 92 North av.
- Duryee William H. blacksmith, h. 5 Julia
- Dusch Geo. carpenter, house 308 N. Clinton
- Dusch Joseph (*Dietz & Dusch*), 309 N. Clinton,
boards 308 do. [Clinton
- Dusch Otto J. shoemaker, boards 308 North
- Dusenbury Eli R. safe lockmaker, Court cor.
Stone, house 45 Troup
- Dusenbury Emily E. widow, h. 4 New York
- Dusenbury John H. brakeman, b. 4 New York
- Dusenbury John W. teamster, house 21
Champlain [Hunter
- Dusenbury Stephen W. carpenter, house 103
- Dutcher Jay, miller, house 42 Gregory
- Dutcher Libbie Miss, teacher painting, bds.
18 South Clinton
- Dutcher Libbie A. widow, boards 17 James
- Dutton Augustus M. bds. 68 South St. Paul
- Dutton Carlos Mrs. house 2 Gibbs
- Dutton Charles, brakeman, boards 10 Stillson
- Dutton Delos H. nurseryman, h. 153 Hudson
- Dutton Harry B. conductor, bds. 10 Stillson
- Dutton Jennie C. physician, 185 Powers'
bldgs. house do.
- Dutton Joseph M. stonecutter, h. 42 Hollister
- Dutton Marvin O. (*S. W. Dibble & Dutton*),
20 East Main, house 8 Broadway
- Dutton Mary P. widow, boards 153 Hudson
- Dutton N. C. Mrs. house 10 Stillson
- Duval Robert, hostler, boards 18 Market
- Dwinell Charles A. carpenter, h. 22 North av.

Dwinell Charles R. fireman, N. Y. C. R. R. house 64 Tappan
 Dwinell Eliza C. widow, house 6 Marshall
 Dwyer Bridget, domestic, 180 State
 Dwyer John, laborer, house 42 Lyell [h. do.
 Dwyer Michael, grocer, 102 Caledonia av.
DWYER MICHAEL, carriage and wagon maker, 26 Vienna, house do.—See p. 603
 Dwyer William H. (*McKenzie & Co.*), house 69 Sherman
 Dwyre Mary, housekeeper, b. 83 East avenue
 Dwyre Michael, shoemaker, boards 9 Otsego
 Dye Edmund, laborer, h. 83 North Union
 Dyer Elvira, widow, house 54 Scio
 Dyer James, deceased, 1875
 Dyer John, maltster, house 63 Pinnacle av.
 Dyer John T. waiter, boards 63 Pinnacle av.
 Dyer John T. Mrs. boards 166 Exchange
 Dyer Walter W. painter, 165 E. Main, house 49 Platt
 Dyer William, house 21 Comfort
 Dygert James H. bartender, 19½ Mill, house 18 Monroe avenue
 Dyke Albert W. student, University of Rochester, boards 37 Chestnut
 Dykins Philip, machinist, Exchange corner Glasgow, house 42 South Washington
 Dykins Philip jr. grocer, 136 Plymouth av. boards 42 South Washington
 Dykins Samuel W. agent, h. 29 Frost avenue
 Dykins Thomas K. printer, boards 42 South Washington
 Dyson Eliza Miss, boards 15 South Union
 Dyson John, gardener, house 17 Goodman
 Dyson Thomas, sawmaker, h. 9 East Maple
 Dywer Martin, cutter, 70 Mill, b. 62 Exchange

EAGAN JAMES, laborer, house rear 13 Green
 Eagan James, bookkeeper, 14 Front, boards 80 Atkinson [West av.
 Eagan Jeremiah, farmer, house Chili road n.
 Eagan John, teamster, boards 9 Briggs' place
 Eagan John, painter, house 161½ West Main
 Eagan Joseph R. boards 30 Kent
 Eagan Joseph W. clerk, 103 State, h. 30 Kent
 Eagan Margaret Miss, house 271 Brown
 Eagan Martin, hostler, 88 N. Water, boards 113½ East Main [c. Cottage
 Eagan Nora Miss, 205 Plymouth av. b. Genesee
 Eagan Patrick, grocer, 55 Prospect, house do.
 Eagan Stephen, salesman, bds. 55 Prospect
 Eagan Wm. blacksmith, 9 Ely, h. 140 Hunter
 Eagen Daniel, farmer, boards Chili road near Rapids road [Rapids road
 Eagen Dennis, farmer, bds. Chili road near
 Eales Elizabeth M. stitcher, b. 18 Broadway
 Eales Lucy, widow, house 18 Broadway
 Eales Lucy B. tailoress, bds. 18 Broadway
 Eames Elliott N. baker, 19 Monroe av. h. do.
 Eanus S. Miss, boards 67 West avenue
 Earl Duane, carpenter, h. 9 Woodford place
 Earl Harriet Miss, house 16 South Ford
 Earl Mary A. laundress, house 20 Atkinson
 Earle Charles, removed from city
 Earle Mary A. domestic, 5 Smith
 Early James M. removed to Buffalo
 Earnest Anthony, groom, State cor. Centre, boards Allen corner Elizabeth

Earnshaw Wm. H. laborer, house 47 Nassau
 East George W. removed to San Francisco
EAST HENRY, market, 24 Front, house 25 Rowe corner First.—See page 558
 East Henry R. clerk, 24 Front, bds. 3 South
 East Side Savings Bank, 127 East Main
 Eastman George, assistant bookkeeper, Rochester Savings Bank, W. Main cor. Fitzhugh, house 49 Jones avenue
 Eastman Joseph A. (*Eastman & Van Voorhis*), house 7 Atkinson
 Eastman Maria, widow, boards 49 Jones av.
 Eastman & Van Voorhis (*J. A. Eastman and M. Van Voorhis*), lawyers, 14 State
 Eastwood Albert C. clerk, 22 State, boards 23 Andrews [Paul
 Eastwood Ruth Mrs. widow, bds. 254 N. St.
EASTWOOD WILLIAM, boots and shoes, 22 State, house 16 S. Clinton.—See under *Population of Towns and Cities*
 Eaton Emiel, carriage trimmer, 3 Canal, bds. 8 North Ford
 Eaton George, marble polisher, 122 South St. Paul, house 54 William
 Eaton Gilbert C. clairvoyant, house 18 Platt
 Eaton Henry, clerk, 44 South av. boards do.
 Eaton Hiram, engineer, house 108 North av.
 Eaton James, shoemaker, h. Saratoga av. n. Bloss
 Eaton Mary Ann Mrs. house 7 Kirk [ard
 Eaton Mary A. widow, h. Champlain n. Sew-Eaton Rodney, house St. Clair cor. Clifton
 Eaton Samuel, h. Goodman n. University av.
 Eaton Samuel C. fishing tackle, 14 Arcade, boards 27 Chatham
 Eaton see Aiton [Maple
 Eberle Frank, moulder, 8 Hill, h. 50 West
 Ebel Christopher, hairdresser, 32 Mill, b. 108 East avenue
 Eberle Nicholas, laborer, b. 128 North Union
 Ebert Nicholas, butcher, 68 Hudson, bds. do.
 Eberwein Barney, frame maker, 110 Front, boards 16 East avenue
 Eberwein Jno. nurseryman, b. 9 Gregory
 Eberwein Margaret J. widow, h. 62 Gregory
 Eberwein Valentine, machinist, 100 South St. Paul, house 9 Gregory
 Ebi Frank J. deceased March 12, 1876
 Ebi Jacob, laborer, 123 Mill, house 5 Childs near Maple [Saxton
 Eble Antony, engineer, N. Y. C. R. R. h. 102
 Eble Joseph, teamster, house 44 Childs
 Eble Joseph jr. teamster, boards 44 Childs
 Eble Theresa L. clerk, 154 W. Main, boards 44 Childs [house do.
 Ebner Edward, saloon, Jackson cor. Green,
 Eccels Wm. J. house 103½ East Main
 Echtenacher John D. baker, 139 N. Water, house 64 Caledonia avenue [Whalen
 Eck John B. cabinet maker, 123 Mill, bds. 3
 Eck Joseph, tailor, house St. Joseph n. Hayward park
 Eckam Peter, engineer, 179 N. St. Paul, h. 16 Buchan park
 Eckel Barbara, widow, h. 6 Bond n. Munger
 Eckel John, helper, 3 Canal, h. Ames near Campbell - [6 Bond
 Eckel Philip, moulder, 187 W. Main, boards

Eckerle Charles P. turner, Aqueduct, bds. 86 Kent
 [Aqueduct, h. 86 Kent
 Eckerle John, furniture manufacturer, foot
 Eckerle John F. turner, Aqueduct, b. 86 Kent
 Eckerson Ann E. widow, b. 36 N. Washington
 Eckert Charles, mason, bds. 251 N. St. Paul
 Eckert John, shoemaker, 111 State, boards
 127 Scio
 Eckert Philip, carpenter, house 45 Nassau
 Eckert Titus, saloon, Clifford near Thomas,
 house do.
 Eckert Wm. laborer, house 50 Sellinger
 Eckhardt Casper, saloon, 106 Exchange, h. do.
 Eckhart Conrad (*Roth & Co.*), 4 South av.
 house 10 do.
 Eckrich Frank, mason, h. 261½ N. Clinton
 Eddy Albert M. & Co. (*A. A. Eddy*), gents'
 furnishing goods, 31 E. Main, house 22
 Howell
 Eddy Arthur A. (*Albert M. Eddy & Co.*), 31
 East Main, boards 4 N. Washington
 Eddy A. Theodore, removed to Chicago, Ill.
 Eddy Charles, pastor, Asbury Methodist
 Church, house 1 University av.
 Eddy Edmund L. boards 85 Lake av.
 Eddy Emily M. widow, b. 3 Livingston park
 Eddy Luther B. salesman, 80 E. Main, b. 85
 Lake avenue
 Eddy Samuel S. & Co. (*W. S. Castleman*),
 morocco manufacturers, 25 North Water,
 boards 27 N. Clinton
 Eddy S. Schuyler, agent, house 102 Frank
 Eddy Thomas, house 85 Lake avenue
 Eddy Thomas H. bds. 85 Lake avenue
 Eddy Zephaniah H. house 46 Hudson
 Edel Bernhard, cooper, Magne near R. R. h.
 Jay near Wackerman
 Edelman John, harness maker, b. 42 Nassau
 Edelman Joseph, mason, house 42 Nassau
 Edelman Lewis (*G. Engert & Co.*), 2 Ham-
 burgh, house 4 Wilson [Wilson
 Edelman Mary A. Mrs. music teacher, h. 4
 Edelman Peter, tailor, Clifford n. St. Joseph,
 boards 201 St. Joseph [b. 57 Asylum
 Edgar H. F. teacher, Hudson School No. 16,
 Edgar Joseph, grocer, 138 North Clinton, h.
 19 Ward
 Edgar Matthew (*Seely & Edgar*), 6 State, h.
 75 Meigs
 Edgar S. A. teacher, boards 57 Asylum
 Edgecumbe Alice, deceased June, 1875
 Edgecumbe Charles W. student, b. 66 South
 St. Paul
 Edgecumbe Emma E. bds. 66 S. St. Paul
 Edgecumbe James O. clerk, 23 Spring, bds.
 66 S. St. Paul
 Edgecumbe Lizzie, house 66 S. St. Paul
 Edgell Geo. H. clerk, Spring cor. Plymouth
 av. bds. 38 Caledonia avenue
 Edgell Mathilda S. grocer, Spring c. Ply-
 mouth avenue, house 38 Caledonia av.
EDGERTON HIRAM H. lumber, 207 S.
 St. Paul n. Griffith, h. 6 Broadway cor.
 Marshall.—*See page 637*
 Edgerton Octavia C. widow, h. 37 Howell
 Edington William, laborer, bds. 5 Genesee
 Edlicker John, laborer, house rear 7 Kirk
 Edmonds Alfred, painter, 3 Canal, h. 20 Julia

Edmonds Calvin H. painter, h. 8 Harvard
 Edmonds Catharine, nurse, bds. 61 East av.
 Edmonds James B. engraver, 88 Powers'
 buildings, house 177 Monroe avenue
 Edmonds Jennie M. Mrs. millinery, 79 East
 Main, house do.
 Edmonds Morris D. piano and organ tuner,
 59 State, h. 11 James [h. 79 E. Main
 Edmonds Wm. E. lawyer, 16 Smith's block,
 Edmunds Geo. G. hairdresser, 5 Exchange,
 house 46 Monroe avenue [house do.
 Edridge Frederick, brassfounder, 70 Court,
 Edson Charles F. removed to Napoleon, Ohio
 Edson Elijah, machinist, 138 Mill, house 4
 Saratoga avenue
 Edson Elijah H. machinist, bds. 2 Lime
 Edson Robert C. solecutter, house 6 Vernon
 Edwards Caroline Mrs. dressmaker, 18 Favor,
 house do.
 Edwards David, driver, National Hotel, b. do.
 Edwards Frank, waiter, 25 Exchange place,
 boards 114 West Main
 Edwards George, removed from city
 Edwards Griffith H. shoemaker, 111 State, h.
 7 Hudson
 Edwards James W. boards 38 Bolivar
 Edwards Rebecca E. Mrs. house 38 Bolivar
 Edwards Susan, widow, house 2 Sophia
 Edwards William gardener, h. 47 Prospect
 Edzel Valentine, cutter, 46 Mill, h. 22½ Kelly
 Efling Antoinette, widow, house 80 Joiner
 Efling Henrietta, widow, h. 92 N. Clinton
 Efling Herman, cigar maker, bds. 80 Joiner
 Efling Henry, laborer, house rear Jay n. James
 Efling Rosna, widow, h. rear Jay n. James
 Effrige John, carpenter, h. 23 Thompson
 Efner Charles, house 12 Broadway
 Egan Alice J. (*Egan & Mack*), boards Hunter
 near Reynolds [Reynolds
 Egan Bridget Miss, stitcher, bds. Hunter n.
 Egan Dennis, deceased Dec. 1875
 Egan Frank, cutter, 83 North Water
 Egan James, laborer, house Fairmount near
 University av. [231 Plymouth av.
 Egan John, shoe cutter, 83 North Water, b.
 Egan John, shoemaker, 87 N. Water, bds. 26
 Centre
 Egan John, saloon, 163 Scio, house do.
 Egan Julia, widow, h. Hunter n. Reynolds
 Egan Mary, widow, house 22 Glasgow
 Egan Thomas J. cabinetmaker, b. Hunter
 near Reynolds
 Egan & Mack (*A. J. Egan and M. J. Mack*),
 hairworkers, 4 Elwood block
 Egbert Andrew J. student, University of
 Rochester, bds. East av. [Sellinger
 Ege Peter, shoemaker, 91 N. Water, house 25
 Egelston Mary E. widow, b. 30 Trowbridge
 Egen Patrick, laborer, h. Genesee n. Seward
 Egerer Anthony, saloon, 162 North av. h. do.
 Egerer Joseph, hairdresser, 162½ North, h.
 176 North
 Egetenmeyer Mary Mrs. h. Clifford n. Maria
 Eggel Andrew, porter, h. Champion corner
 Clarkson
 Eggert Anna, tailoress, boards 26 Hoeltzer
 Eggert John H. G. laborer, house 26 Hoeltzer
 Eggleston Geo. W. constable, h. 422 Brown

- Eglinton James A. boards 16 South Union
 Eglinton Margaret, widow, h. 16 S. Union
 Ehde Frederic, carpenter, house 24 Flint
 Ehde Hannah Miss, dressmaker, b. 24 Flint
 cor. Reynolds [near Norton
 Ehinger Charles, ice, boards North St. Paul
 Ehinger Frank, removed to Pittsford
 Ehinger Gertrude Mrs. widow, h. North St.
 Paul n. Norton [near Norton
 Ehinger Victoria, tailoress, b. North St. Paul
 Ehl Jacob, carver, Aqueduct n. Canal, h.
 39 Baden
 Ehrhardt Margaret, finisher, b. 54 W. Maple
 Ehrhardt Mary A. widow, h. 54 W. Maple
 Ehrhardt William, shoe cutter, 4 Allen, bds.
 183 Brown [Allen, h. 56 West Maple
 Ehrhart John N. (*Ehrhart & Stickline*), 40
 Ehrhart & Stickline (*J. N. Ehrhart and L.
 Stickline*), saloon, 40 Allen
 Ehrle Wm. file cutter, River n. N. Water, b.
 15 Lowell
 Ehrman Henry, repairer, h. Jay cor. Orchard
 Ehrmantraut Charles, lumber inspector, Ex-
 change n. Troup, h. 1 Victoria
 Ehrmantraut Charles F. salesman, Exchange
 near Troup, h. 50 Saxton
 Ehrmantraut Henry, laborer, h. 53 Campbell
 Ehrstein Andrew, tailor, 10 W. Main, boards
 86 Smith
 Ehrstein Antony, house 86 Smith
 Ehrstein Antony, jr., stonecutter, Oak cor.
 Smith, h. 16 Grape
EHRSTEIN BROS. (*M. and J. Ehrstein*),
 stonecutters and contractors, Oak corner
 Smith.—*See page 639*
 Ehrstein John (*Ehrstein Bros.*), h. 98 Smith
 Ehrstein Michael (*Ehrstein Bros.*), h. 88 Smith
 Eibler John, bricklayer, h. 21 Mt. Hope av.
 Eibler Mary, widow, house 59 Cypress
 Eichelberg August, car cleaner, h. 51 Vienna
 Eichelberg Margaret Mrs. dressmaker, 51
 Vienna, h. do. [bds. 158 N. Clinton
 Eichelman Charles W. hairdresser, 3 Mill,
 Eichelman Emil, printer, 23 West Main, b.
 158 North Clinton [158 N. Clinton
 Eichelman Henry, machinist, 138 Mill, h.
 Eichholzer Joseph, laborer, h. Mt. Vernon
 avenue
 Eichhorn Richard, currier, b. 16 Mansion
 Eichman Helena, widow, h. 73 North av.
 Eichman Julius, bookkeeper, 68 Mill, boards
 73 North av. [46 Clinton place
 Eichman Louis, grocer, 148 East Main, h.
 Eichorn Anna Miss, tailoress, h. 19 Franklin
 Eichorn Frank G. bookbinder, 27 Smith's blk.
 boards 19 Franklin
 Eichorn George, engraver, house 134 Adams
 Eichorn Johanna, tailoress, bds. 19 Franklin
 Eichorn William, peddler, 144 E. Main, h.
 102 Champlain [bds. 14 Sellinger
 Eickart Charles, optician, 179 North St. Paul
 Eikart Christian, mason, h. 24 Buchan park
 Eikart Frederick W. clerk, 36 Exchange, h.
 6 Elizabeth place
 Eikart John, laborer, house 14 Sellinger
 Eikert Charles, grinder, 136 Mill, boards 24
 Buchan park [Champion
 Eilers Bernard, millwright, lower falls, h. 3
 Eilers Bernard, jr. paper maker, lower falls,
 boards 3 Champion [h. 36 German
 Eilinger Charles, machinist, Brown c. Jones,
 Eilinger Christian F. shoemaker, 124 Front,
 house 37 Sellinger [house 20 Wilson
 Eilinger Henry S. machinist, Brown c. Jones,
 Eilinger Mary, widow, house 26 St. Joseph
 Einsfield George G. turner, h. 121 Chatham
 Einsfield John V. upholsterer, 74 State, bds.
 57 Nassau
 Einsfield Margaret, widow, h. 121 Chatham
 Eipper Augustus H. saloon, 30 Mumford, h.
 do. [30 Mumford
 Eipper Thomas C. telegrapher, 7 Arcade, b.
 Eisele Adolph, removed to Villengen, Ger-
 many
 Eisele Albert, removed to Cleveland, Ohio
 Eisele Michael, cabinetmaker, 184 State, h.
 29 Holland [Buchan park
 Eisemann Adam, blacksmith, 136 Mill, h. 37
 Eisemann Bros. (*C. and J. Eisemann*), mag-
 ket, St. Joseph cor. Herman
 Eisemann Christopher (*Eisemann Bros.*), bds.
 20 Holland [Holland
 Eisemann John (*Eisemann Bros.*), boards 20
 Eisemann Louis J. vinegar manuf. 73 Nassau,
 house 20 Holland [Clifford, h. do.
 Eisemann Michael, grocer, North avenue c.
 Eisemann Philip, baker, b. N. av. c. Clifford
 Eisen Adolph, cutter, 6 Exchange place, b.
 129 North Clinton [n. Pinnacle av.
 Eisenberg Adam, laborer, h. Henrietta av.
 Eisenberg Christina, widow, h. Henrietta av.
 cor. Pinnacle av. [house do.
 Eisenberg Conrad, grocer, 174 Pinnacle av.
 Eisenberg Geo. machinist, 188 State, boards
 48 Davis [48 Davis
 Eisenberg Henry, safemaker, 188 State, bds.
 Eisenberg Henry F. shoemaker, 30 Franklin,
 bds. 116 N. Water
 Eisenberg John, laborer, house 19 Cypress
 Eisenberg William, machinist, 3 Canal, h.
 44 Caroline
 Eisenberg William, laborer, house 48 Davis
 Eisenhauer Geo. J. stonecutter, Oak c. Smith,
 bds. Brown c. Frances [Bauer
 Eisenhauer John, laborer, h. Michigan near
 Eisenhauer Louis, blacksmith, house 238 St.
 Joseph
 Eisenhauer Stephen, shoemaker, 7 S. St. Paul,
 house 236 St. Joseph [b. 11 Bay
 Eisenmenger Adam, tanner, 87 North Water,
 Eisenmenger Martin, grocer, 37 Broadway,
 house do.
 Eisenmenger Peter, baker, 154 W. Main, h. do.
 Eisenzaemer Stephen, butcher, 119 North
 Clinton, boards do.
 Eisman George, laborer, house 21 Whitney
 Eisman Adam, carriage trimmer, 13 Canal,
 boards 42 Madison
 Eismann Barthol, tailor, 42 Madison, h. do.
 Eismann Catharine, widow, h. 14 North York
 Elam Jabez, finisher, 73 North Water, house
 at Irondequoit
 Elbs George, baker, 117 Lyell, house do.
 Elderkin John, shoemaker, 124 Front, boards
 82 Atwater [Glasgow, h. 74 Cypress
 Eldredge George W. engineer, Exchange opp.

- Eldredge Geo. E. student, University of Rochester, boards 110 University avenue
 Eldredge Luther F. engineer, N. Y. C. R. R. house 45 Chatham
 Eldridge Ann, widow, house 189 N. St. Paul
 Eldridge Louis P. clerk, 1 Powers' buildings, boards 189 North St. Paul
 Eldridge Lyman A. boards 16 Fitzhugh
 Eldridge Salathiel, fruit peddler, house 160 East Main
 Eletson Charles, removed to California
 Eletson Charles H. house 58 Oak
 Eley Jennie, widow, h. Spring c. Plymouth av.
 Elgar Ebenezer, house 8 Hickory
 Elger Louis, teamster, 332 State, boards do.
 Eli Perry, clothing, 74 Front, house do.
 Elias Edward, wiper, boards 14 Tyler
 Elias Jacob, laborer, Jay cor. Erie canal, h. Clifford
 Elias John, laborer, house 14 Tyler
 Elias John jr. painter, 22 S. St. Paul, boards 14 Tyler [avenue
 Elit Christian, laborer, h. Jennings n. North
 Ellas Edward H. printer, 3 West Main, bds. 146½ do. [Chatham
 Ellas Josiah Y. clerk, 73 E. Main, house 16
 Ellems John, finisher, house 42 Smith
 Ellems Mary A. widow, boards 42 Smith
 Ellender Harry, painter, house 32 Bloss
 Ellery Frank M. cashier, 16 Exchange, house 44 Adams
 Ellery Mattie, seamstress, boards 53 Jay
 Ellery Willis C. clerk, 21 W. Main, b. 146½ do.
 Elliboat John J. painter, 9 West Main, boards 62 Exchange
 Ellingworth Stephen F. Mrs. h. 56 Tremont
 Elliot Andrew J. weaver, Rochester Cotton Mill, house 152 Lyell
 Elliot David F. removed to Philadelphia, Pa.
 Elliot Joseph jr. fireman, pulp mills, N. St. Paul, middle falls, boards 2 Frank
 Elliot Josiah, roofer, house 23 Clifton
 Elliott Abraham, carpenter, foot White, h. 38 Grape [22 Allen
 Elliott Alfred H. bartender, 124 State, house
 Elliott Charlotte E. widow, bds. 38 Hickory
 Elliott Frank A. removed to Buffalo
 Elliott Franklin R. gardener, b. 58 Broadway
 Elliott George W. night editor Democrat and Chronicle, 3 W. Main, bds. 34 Fitzhugh
 Elliott Isabella Mrs. boarding house, 2 Frank, house do.
 Elliott Joseph, house 2 Frank
 Elliott Mary A. millinery, 33 Scio, house do.
 Elliott William S. pressman, house 9 Kent
 Ellis Angus M. removed to Henrietta
 Ellis Benjamin, painter, house 3 Stone
 Ellis Betsey A. finisher, house 7 Kirk
 Ellis Edgar E. whip mounter, house 48 Scio
 Ellis Elisha B. carpenter, house 120 Broadway
 Ellis Eliza A. Mrs. dressmaker, h. 78 Monroe av.
 Ellis George, framemaker, 38 Gorham, boards 109 Chatham
 Ellis James H. clerk, 29 W. Main, h. 7 Sophia
 Ellis John N. harnessmaker, 25 S. St. Paul, boards West Main
 Ellis Mabel Miss, boards 9 Swan
 Ellis Mary, widow, house 109 Chatham
 Ellis Mary H. Mrs. boards 84 West avenue
 Ellis Minerva, boards 7 Kirk
 Ellis Sylvenus A. house 7 Clifton
 Ellis William C. house 52 South Ford
 Ellis William H. salesman, house 67 Martin
 Ellis William M. house Mason near First
 Ellis William S. caulker, Meigs st. bridge h. 118 Broadway
 Ellis, see Ellas and Allis [10 E. Main
 Ellison Frank T. bookkeeper, 77 N. Water, b. Water, bds. 10 East Main [E. Main
 Ellison Geo. W. (*Ellison & Stoddard*), 77 N. Water, bds. 10 East Main [E. Main
 Ellison Nathaniel B. 77 N. Water, house 10
 Ellison William, teamster, 311 State
 Ellison & Stoddard (*G. W. Ellison and G. Stoddard*), shoe manuf. 77 North Water
 Ellsworth Charles H. dentist, 43 State, house 72 William
 Ellsworth David E. G. removed to Batavia
 Ellsworth Edward F. porter, 17 State, house 45 Emerson
 Ellsworth Henry M. (*Geo. H. Thompson & Co.*); E. Main c. North av. boards 206 E. Main
 Ellwanger Frederick, gardener, house Lake avenue n. tollgate [140 Mt. Hope av.
 Ellwanger George (*Ellwanger & Barry*), house
 Ellwanger George H. pres. Evening Express Printing Co. 23 West Main, h. 138 Mt. Hope avenue [boards 140 do.
 Ellwanger Henry B. 134 Mt. Hope avenue,
 Ellwanger & Barry (*G. Ellwanger and P. Barry*), nurserymen, 134 Mt. Hope av.
 Ellwood Thomas, miller, bds. York House
 Elmer Amelia Mrs. house 42 Thomas
 Elmer Lizzie, teacher, 33 Spring, boards do.
 Elmore Anthony, laborer, house 22 Cliff
 Elmore Susan, cook, Whitcomb House, b. do.
 Elphick Thomas, mason, h. Penn n. Morgan
 Elsenbeck Michael, house 152 Plymouth av.
 Elsenheimer Bernhardt, baker, 43 Monroe avenue, boards do.
 Elsensohn Anton, tailor, 14 Rauber, bds. do.
 Elser John, baker, house E. Maple c. Frances
 Elsheimer Daniel C. removed to Utica
 Elsheimer Louis P. jeweler, 15 Smith's blk. boards 217 Exchange
 Elton Fanny P. Miss, teacher, Andrews' school No. 9, boards 12 James
 Elwell Elijah D. salesman, 73 East Main, h. 11 Chatham [2 Eagle
 Elwood Alfred (*Wray & Elwood*), 34 Mill, h.
 Elwood George M. insurance agent, 55 West Main, house 73 Fitzhugh
 Elwood James M. clerk, 55 W. Main, bds. 73 Fitzhugh
 Ely Abraham P. house 2 Greig
 Ely Alfred, lawyer, 28 Powers' buildings, h. Plymouth avenue c. Troup
 Ely Andrew, grocer, 114 West av. house do.
 Ely Angeline, widow, h. Hudson c. Bernard
 Ely Catharine, widow, house 34 W. Maple
 Ely Erastus U. clerk, 92 State, bds. Hudson cor. Bernard
 Ely Fred. teamster, 8 West av. boards 11 do.
 Ely George E. whip maker, h. 32 Ambrose
 Ely Henry P. boards 2 Greig
 Ely John W. clerk, 53 E. Main, b. 114 West av.
 Ely Joseph A. clergyman, bds. 69 Fitzhugh

A. R. PRITCHARD & LIKLY,

TRUNKS AND BAGS, WHOLESALE AND RETAIL, No. 78 STATE STREET.

Ely Lorenzo D. farmer, h. East av. c. Bower
 Ely Lorenzo D. jr. boards East av. c. Bower
 Ely Samuel D. foreman, Allen n. N. Wash-
 ington, house 40 Ambrose [69 do.
 Ely William S. physician, 67 Fitzhugh, bds.
 Ely William W. physician, 67 Fitzhugh, h.
 69 do.
 Ely Wilmer M. builder, h. Hudson c. Norton
 Ely see Eley
 Emblow Charles, deceased, February 19, 1876
 Emblow Charles J. waiter, boards 301 State
 Emblow William, (basement) Arcade, h. 44
 Brown's alley [Clinton Hotel
 Embry Frank W. freight agent, 83 State, b.
 Embry Herbert H. bookkeeper, 83 State, b.
 70 South St. Paul
 Embury John E. dentist, 14 State, h. 33 Hunter
 Embury Rindie, dressmaker, bds. 38 Hunter
 Embury Robert S. collar maker, 98 E. Main,
 house 38 Hunter
 Emens Henry G. removed to Ogdan
 Emer Anthony, clerk, 131 Scio, boards do.
 Emer Stephen, grocer, 131 Scio, house do.
 Emerich Conrad, carriage maker, 101 North
 avenue, house Channing n. North
 Emerick John, blacksmith, 3 Canal, bds. 122
 Chatham [house 11 Cady
 Emerson A. Frank, blacksmith, Mill n. Brown,
 Emerson Charles H. clerk, bds. 38 Chatham
 Emerson Elizabeth E. G. Mrs. house 71 Ply-
 mouth avenue
 Emerson George H. boards 38 Chatham
 Emerson John B. cabinet maker, 111½ North
 Water, house 27 Hudson
 Emerson Mary E. Miss, boards 38 Chatham
 Emerson Sarah Ann, widow, h. 38 Chatham
 Emerson Willard J. boards 2 Franklin square
EMERSON WILLIAM, Rochester Batting
 Mill, 153 N. Water, and Spring Foun-
 tain Ice, 322 N. St. Paul, house do.—
 See page 572
 Emerson William N. 96 Powers' bldgs. house
 2 Franklin square
 Emery James B. machinist, boards 7 Bolivar
 Emery Levi, millwright, 120 Mill, house 7
 Bolivar
 Emery Lorenda, dressmaker, bds. 58 Allen
 Emery Loretta, dressmaker, 58 Allen, b. do.
 Emery Mary, nurse, boards 58 Allen
 Emery Nathan M. mason, h. 200 Monroe av.
 Emery Norman C. clerk, 40 Allen, b. 58 do.
 Emery Phebe R. widow, house 58 Allen
 Emery Warren L. bookkeeper, b. 7 Bolivar
 Emlianne Mary, teacher, bds. Jay c. Frank
 Emmel George, cooper, 30 Canal, house 102
 Smith
 Emmel John, laborer, house 208 Jay
 Emmel Joseph, cooper, house 234 Jay
 Emmerich George, wagon maker, 125 N. St.
 Paul, house 122 Chatham
 Emmerich Joseph, wagon maker, 125 N. St.
 Paul, house 5 Ringlestein alley
 Emo Conrad, flour packer, Flour City Mills,
 house 15 Galusha
 Emperor John, laborer, h. Reynolds c. Tremont
 Empey Archibald, laborer, house 9 Brisbane
EMPIRE MOULDING WORKS (G. H.
 Newell), 37 Gorham.—See page 609

Empte Fred. teamster, 255 N. St. Paul, h.
 flats, middle falls [house 19 Cole
 Emrich Edward, machinist, 149 N. Water,
 Emrich Edward jr. machinist, bds. 19 Cole
END FERDINAND, boots and shoes, 7
 Andrews, h. 32 Herman.—See page 667
 End Joseph G. cleik, 7 Andrews, boards 32
 Herman
 Enders Charles, clerk, boards 12 Baden
 Enders John C. grocer, Frances c. Frost av.
 house do.
 Enders Konrad, deceased, March, 1876
 Enders Martin, tool maker, house 8 Draper
 Enders Mary A. widow, house 12 Baker
 Endlekofer Joseph, mason, h. Bernard near
 Thomas
 Endler Jacob C. tanner, house 12 Mansion
 Endres Charles, house 38 Vienna
 Endres John, blacksmith, house 146 Cady
 Endres Mary Mrs. saloon, 61 Jay, house do.
 Engel Catharine, widow, boards 8 Evergreen
 Engel Charles, laborer, house 103 Hudson
 Engel Charles jr. shoemaker, b. 103 Hudson
 Engel Frederick, shoemaker, h. 55 Scrantom
 Engel Leo, mason, house Caroline n. Meigs
 Engel Leopold, bricklayer, house 84 Chatham
 Engel Louis, removed to Greece
 Engelhardt Albert, show case maker, Ex-
 change c. Court, house Pine n. Troup
 Engelhardt Charles T. clerk, 28 Arcade, bds.
 14 Pitt
 Engelhardt Conrad, laborer, house 88 Meigs
 Engelhardt Edward, clerk, bds. Chatham c.
 Atwater
 Engelhardt Frederick G. bookkeeper, 7 Ply-
 mouth av. bds. 137 North Clinton
 Engelhardt Henry, machinist, 188 State, h.
 213 Jay
 Engelhardt John, house 90 Meigs
 Engelhardt John, cutter, 54 W. Main, house
 15 Marietta [Atwater
 Engelhardt Paul, constable, h. Chatham cor.
 Engelmann Linda, fancy goods, 253 N. Clin-
 ton, house do.
 Engelmor George, butcher, house 54 Sanford
 Engemann Henry, shoemaker, 77 N. Water,
 house 25 Thomas
 Engert Barbara, widow, h. Norton n. Hudson
 Engert Barney J. (G. Engert & Co.), 149 Ex-
 change, boards 40 Marshall
 Engert Frank, farmer, b. Norton n. Hudson
ENGERT GEORGE & CO. (B. J. Engert
 and Lewis Edelman), coal, 149 Exchange
 and 2 Hamburg, house 40 Marshall.—
 See page 600
 Engert John S. clerk, 5 Mill, b. 44 William
 Engert Martin, laborer, house 230 St. Joseph
 Engert Susan Miss, vestmaker, h. 44 William
 Engler Andrew, laborer, house 31 Herman
 Engler Barbara, hair worker, 131 East Main,
 bds. 121 N. St. Paul [56 Martin
 Engler Ferdinand, bootcrimper, 51 Front, h.
 Engler George, tailor, house 62 Hanover
 Engler Henry, bootmaker, 9 N. Clinton, h.
 9 Clinton place
 Engler Jacob, tanner, h. 231 Plymouth av.
 Engler John, salesman, 73 East Main, bds.
 31 Herman

- Englert Adeline, seamstress, boards 7 Clifford
 Englert Anthony, grocer, 258 N. Clinton, h. do.
 Englert Anthony, screw cutter, 123 Mill, bds. 15 Clifford
 Englert Catharine, widow, h. 19 Bismark pl.
 Englert Charles, saloon, 4 Andrews, h. do.
 Englert Frank, tailor, 48 Martin, house Conkey avenue near Clifford
 Englert George, blacksmith, h. Miller n. Bay
 Englert George, packer, 73 State, h. Crouch near University avenue
 Englert Jacob, boards 46 Lowell
 Englert John, laborer, house 64 German
 Englert John, baker, 12 West avenue, house 33 Baden [3 Bismark place
 Englert John, brewer, 7 Atwater, boards
 Englert John, shoemaker, 91 N. Water, h. 22 Leopold
 Englert John, mason, house 7 Clifford
 Englert John, sole cutter, 111 State, house 49 Weeger
 Englert Joseph Mrs. house 47 Childs
 Englert Joseph, laborer, house 28 Rauber
 Englert Louis, laborer, house 46 Lowell
 Englert Margaret, widow, house 8 Clifford
 Englert Margaret C. married to Wm. H. Pritchard
 Englert Martin, deceased January, 1876
 Englert Martin, mason, bds. 30 Conkey av.
 Englert Mary, tailoress, bds. 8 Clifford
 Englert Michael, laborer, 255 N. St. Paul, h. 15 Clifford
 Englert Michael, saloon, 86 St. Joseph, h. do.
 Englert Peter A. dry goods, 201 N. Clinton, house do. [house 310 N. Clinton
 Englerth Sebastian, wagonmaker, 17 Division,
 English Alban T. removed to New York
 English Albert R. grocer, 94 Caledonia av. house do. [do.
 English Grandon J. student, 25 Fitzhugh, b.
 English Irene E. widow, house 4 East park
 English James W. boards 4 East park
 English Joseph E. driver, 144 E. Main, bds. 36 Clinton place
 English Robert B. gardener, Rochester Orphan Asylum, house 224 Exchange
 English William, laborer, Platt c. Kent, bds. 33 Frank
 Ennecker Louis, lithographer, 7 Market, h. 8 Whitmore park near Meigs
 Ennecker Louis jr. (*Ennecker & Karle*), bds. 68 South St. Paul
ENNECKER & KARLE (*L. Ennecker jr. and W. Karle*), lithographers, 35 State. See opposite page 624.
 Ennis George, painter, house 12 Sherman
 Ennis Jane, widow, rear 17 Mt. Hope av.
 Enos B. Frank, clerk, Police Commissioners City Hall, house 15 Alexander
 Enos Mary, widow, boards 15 Alexander
 Enright Annie M. Miss, house 164 State
 Enright Daniel (*P. Enright & Son*), Mill cor. Factory, boards do. [bds. do.
 Enright John F. bookkeeper, Mill c. Factory,
 Enright Margaret Miss, house 164 State
 Enright Margaret, widow, h. 30 Brown's alley
 Enright Patrick & Son (*D. Enright*), brewery, Mill c. Factory, house do.
- Enright William H. tinsmith, boards 30 Brown's alley [2 Brisbane
 Ensign Luther, papermaker, Paper Mill, b.
 Ensmann Adolph, grocer, h. 105 North av.
 Ensmann Adolph jr., clerk, house 247 North Clinton
 Ephrim Sister, teacher, bds. Jay c. Frank
 Eppel Martin, removed from city
 Eppel Mary Mrs. house 76 South Union
 Epping Frank, moulder, 20 Court, house 184 Pinnacle avenue
 Epps Robert, hair dresser, house 54 N. Water
 Epstein Edward H. salesman, house 162 N. Clinton
 Epstein Henry, house 17 Park avenue
 Erb Herman, shoemaker, 83 North Water, boards 143 Campbell [Campbell
 Erb John, laborer, Jay c. Saxton, house 62
 Erb John F. hairdresser, boards 62 Campbell
 Erb Wm. shoemaker, 83 N. Water, boards 143 Campbell [house 115 Jay.
 Erbach Caspar, blacksmith, Brown c. Jones,
 Erbach Henry, removed to Madison, Wis.
 Erbach Jacob, blacksmith, Platt, h. 78 Saxton
 Erbacher Frank, watchman, 29 Powers' buildings, house 15 Lowell
 Erbeling Joseph, saloon, 50 S. St. Paul, h. do.
 Erbelding William, rectifier, 132 West Main, house 103 Orchard
 Erbshauer Edward, cabinetmaker, 179 N. St. Paul, boards 42 Martin [house do.
 Erden Frank, cigar maker, 9 Shamrock,
 Erden Frederick, cigar maker, bds. 91 Front
ERDLE FREDERICK, machinist, 129 Mill, house 68 Martin.—See page 672
 Erdle Joseph A. machinist, 129 Mill, boards 68 Martin
 Erdle Marcia, removed to Canandaigua
 Erdle Martin, market, 100 South avenue, h. 74 Gregory [ton n. Bloomingdale av.
 Ereth Anthony, laborer, house North Clin-
 Ereth Frank, sashmaker, boards N. Clinton n. Bloomingdale av.
 Ereth John, sashmaker, b. N. Clinton near Bloomingdale av. [depot, h. 183 Brown
 Erhardt Andrew, engineer, N. Y. C. R. R.
 Erhardt Elizabeth, widow, house 4 Terry
 Erhardt Ferdinand, laborer, house 17 Cole
 Erhardt Frederick, machinist, Mill c. Factory, boards 17 Tonawanda
 Erhardt Henry P. fireman, b. 17 Tonawanda
 Erhardt Mary, domestic, bds. 52 S. Union
 Erhardt Matthew, engineer, h. 17 Tonawanda
 Erickson Aaron (*Erickson, Jennings & Mumford*), house East av. near Alexander
ERICKSON, JENNINGS & MUMFORD, (*A. Erickson, G. E. Jennings, and G. E. Mumford*), bankers, 25 State.—See p. 501
 Erler J. Edward, clerk, 71 Hudson, bds. do.
 Erler William, grocer, 71 Hudson, house do.
ERNISSE ABRAHAM & SON (*J. Ernisse*), painters, 88 Powers' bldgs. h. 29 Prince.—See page 644
 Ernisse Abraham jr. janitor, Powers' bldgs. house 26 Hollister
 Ernisse Adrian, upholsterer, 42 East Main, house 7 Chestnut pk.
 Ernisse Isaac, laborer, house 67 Gregory

Ernisse James (*A. Ernisse & Son*), house 34 South avenue
 Ernisse James P. carpenter, h. 40 Reynolds
 Ernisse John, blacksmith, house 10½ Gregory
 Ernisse John, box maker, ft. Centre, boards 40 Frost avenue
 Ernisse John H. boards 29 Prince
 Ernisse Magdalene D. boards 15 Pleasant
 Ernisse William S. clerk, 54 State, boards 29 Prince
 Ernst Anton, hostler, 159 State, b. 25 Allen
 Ernst Charles B. student, boards 7 Chestnut
 Ernst Christian, laborer, h. Berlin n. Hudson
 Ernst Christian, butcher, 104 West Main, h. 33 Jay
 Ernst Christopher, butcher, house 33 Magne
 Ernst Edward J. salesman, 3 West Main, bds. 7 Chestnut
 Ernst George L. clerk, 19 North av. boards 28 Franklin [Franklin
 Ernst Lorenz (*Ernst & Schwalb*), house 28
ERNST LOUIS, hardware and cutlery, 3 West Main, h. 7 Chestnut.—*See page 630*
 Ernst Louis J. clerk, 3 West Main, boards 7 Chestnut [9 Atwater
 Ernst Philip, harness maker, 59 Front, house
 Ernst Rosina, house 9 South avenue
 Ernst Wendel, carpenter, 93 Exchange, bds. 28 Franklin
 Ernst & Schwalb (*Lorenz Ernst and Nicholas Schwalb*), coal yard, 19 North avenue
 Erstein John, stone cutter, h. 98 W. Smith
 Erstein Thomas, laborer, h. Ames n. R. R.
 Ertle George, cabinetmaker, 7 N. Water, h. 105 Wilder
 Ertle John, baker, 50 Orange, house do.
 Ervin Samuel, removed from city
 Erwin Augustus M. removed to Syracuse
 Erwin Henry J. painter, boards 87 South av.
 Erwin James, steward, Brackett House, h. 29 Brown
 Erwin Thomas, carpenter, house 73 Adams
 Erwin, see Irwin
 Escott Ann, widow, house rear 32 Ward
 Escott Silestia Mrs. seamstress, h. 13 Tyler
 Escott William J. laborer, house 13 Tyler
 Esemann Gustavus, music teacher, house 18 Tyler
 Esse Peter, cooper, 180 Jay, house do.
 Essex Lyman H. salesman, house rear 159 South avenue [49 Vienna
 Esson Louis A. printer, 23 West Main, bds.
 Estee William C. bookkeeper, 36 Exchange, boards 5 Livingston place
 Estelman George, brewer, 106 Lake av. house 12 Brisbane [Webster road
 Ester Conrad, butcher, house Goodman near
 Ester Henry J. butcher, h. Caroline n. Meigs
 Estermans Jacob, laborer, h. Norton n. Carter
 Estes Stephen R. removed to Rued's corners
 Etheridge Hamlet E. painter, 66 Arcade, house do. [boards National Hotel
 Etheridge O. Hamlet, sign writer, 66 Arcade,
 Etheridge Jacob S. boards 29 South avenue
 Ets John W. carpenter, house 34 Frost av.
 Ets Peter, carpenter, house 78 Reynolds
 Ets Peter C. painter, 109 State, boards 78 Reynolds

ETTENHEIMER ELIAS S. & Co. (*Wm. Müller and S. L. Ettenheimer*), watches and jewelry, 2 State, house 3 Elm.—*See page 515*
 Ettenheimer Jacob, jeweler, h. 42 Clinton pl.
 Ettenheimer Moses (*Loventhal & Ettenheimer*), 10 Mumford, bds. 42 Clinton pl.
 Ettenheimer Samuel L. (*E. S. Ettenheimer & Co.*), 2 State, house 35 Chatham
 Ettle George, cabinetmaker, 7 North Water, house 105 Wilder
 Etts Cornelius, deceased August, 1875
 Etts Geritts, carpenter, Brown's al. house 38 Tappan
 Etts Norris, machinist, Court corner Stone, h. 112 Champlain
 Etz George S. removed to Portland, Maine
 Etzel Valentine, cutter, 46 Mill, h. 22½ Kelly
 Euler Phebe, widow, house 32 Franklin
 Eulerick Frederick, tailor, boards 51 North av.
 Eustace Alice, widow, house 13 East Maple
 Eustace Annie, laundress, bds 13 E. Maple
 Eustace James (*Monaghan & Eustace*), 9 Division, house 13 East Maple
 Eustace John, expressman, bds. 13 E. Maple
 Eustace Joshua H. brakeman, N. Y. C. R. R. house 9 Helena
 Eustace Patrick, expressman, b. 13 E. Maple
 Eustace Sarah Miss, boards 21 Jones avenue
 Eustace Stephen, expressman, boards 13 E. Maple [Mt. Vernon av. n. Cayuga pl.
 Euten Charles, driver, 117 N. Clinton, house
 Evangelist Sister, Convent of Nazareth, Jay corner Frank [boards 184 St. Joseph
 Evans Alexander, cutter, River c. N. Water,
 Evans Ann, forewoman, boards 46 Joiner
 Evans Anne, widow, house 46 Joiner
 Evans Charles D. teacher, 96½ E. Main, bds. 35 Glasgow
 Evans Charles E. actor, bds. 3 Franklin sq.
 Evans Addie W. widow, house 37 Saxton
 Evans Evan & J. plane manufs. 13 N. Water, house 3 Franklin square
 Evans George core maker, Brown's race near Furnace, house 49 Thompson
 Evans Herbert G. pressman. 3 West Main, boards 118 Adams
 Evans James (*E. & J. Evans*), h. at Brighton
EVANS JAMES J. shoe manuf. River near N. Water, h. 52 N. St. Paul.—*See p. 666*
 Evans James P. bookkeeper, h. 6 Chatham
 Evans Jane, widow, house 7 Emmett
 Evans John, carpenter, house 89 Tremont
 Evans John C. baggage man, N. Y. C. & H. R. R. depot, boards 7 Emmett
 Evans John M. shoemaker, River near N. Water, house 20 Kelly
 Evans Margaret, widow, house 68 West av.
 Evans Mary G. widow, house 118 Adams
 Evans Robert T. clerk, 122 State, boards 7 Emmett [house 69 Gregory
 Evans Thomas A. letter carrier, post office,
 Evans Truby, bds. North avenue near Norton
 Evans William C. clerk, 64 State, boards 7 Emmett [place
 Evans William H. agent, house 16 Clinton
 Evans William T. foreman, River corner N. Water, house 184 St. Joseph

- EVENING EXPRESS PRINTING CO.** publishers Rochester Evening Express, 23 West Main.—*See opposite page 528*
- Everest Charles M. refined petroleum, 128 Powers' bldgs. boards 30 Stone
- Everest Hiram B. secretary Vacuum Oil Co. 128 Powers' buildings, house 30 Stone
- Everest Horace D. house 234 Exchange
- Everets Hattie, nurse, b. East avenue corner Alexander
- Everett John, laborer, house 66 Pearl
- Everett Washington, sawyer, bds. 66 Pearl
- Evernden Martha, widow, house 8 Stillson
- Evershed Thomas, civil engineer, house 50 Marshall [Culver
- Evershed John T. farmer, h. Monroe av. n.
- Evert William H. piano maker, 4 Hill, house 39 McDonald avenue
- Eves Charles M. shoecutter, 4 Allen, boards 220 North St. Paul
- Eves Henry M. Mrs. h. 220 North St. Paul
- Eves William, physician, 9 Franklin, b. do.
- Eves William H. gilder, 8 Allen, boards 220 North St. Paul [bldg. b. 17 Almira
- Ewald Edward, cabinet maker, Hydraulic
- Ewald Frederick, tailor, boards 17 Almira
- Ewald Nicholas, tailor, house 17 Almira
- Ewart John, laborer, h. rear Chili road near city line
- Ewell Jirah B. student, Roch. Theological Seminary, boards Trevor Hall
- Ewing Hannah A. seamstress, bds. 25 Grape
- Ewing William, peddler, house 25 Grape
- Ewing William P. lawyer, bds. 110 Genesee
- Ewing William T. carpenter, r. 59 Asylum, house 71 Ontario
- Exstein Hiram & Co. (*S. Weil*), men's furnishing goods, 54 Mill, house at Buffalo
- Eyer Mary Miss, tailoress, b. Champion cor. Leavenworth al. [cor. Champion
- Eyer Mary, widow, house Leavenworth al.
- Eyer Michael, cabinet maker, 7 N. Water, house 18 Thorn
- Eyre Joseph, coachman, 50 Lake avenue
- FAAS CORNELIA M.** widow, house 6 Herman
- Faas Daniel, laborer, 20 Court, h. r. Hudson near Norton [Huron
- Faas John, laborer, 20 Court, h. Hudson n.
- Faatz Charles L. market, 201 Monroe avenue, house Goodman cor. Monroe avenue
- Faber Christian, optician, 179 N. St. Paul house Herman cor. Thomas
- Faber Gottfried, filegrinder, h. 42 Hanover
- Faber Louis, flour packer, h. 43 Vienna
- Faber William, machinist, 22 S. St. Paul, b. 42 Hanover
- Fable Calvin L. machinist, boards 13 Almira
- Fable Charles J. marble cutter, 122 S. St. Paul, boards 13 Almira [13 Almira
- Fable Frederick, varnisher, 74 State, house
- Fabling Samuel (*McCoy & Fabling*), h. Keeler near Monroe avenue
- Fabriger John, carpenter, house 6 Marshall
- Fackler John, cigarmaker, 132 Lake av. h. 7 Clakson
- Fackler John P. boards 138 Lake avenue
- Fachy John W. waiter, Osburn House
- Fagan William, laborer, 50 N. Water, boards 15 Catharine [15 Catharine
- Fagin William, laborer, 65 N. Water, bds.
- Fahrene Jacob, basket maker, h. 51 Whitney
- Fahrer Jacob, tailor, boards 24 Hawkins
- Fahrer John, grocer, Smith c. Saxton, h. do.
- Fahrer Nicholas, tailor, house 24 Hawkins
- Fahy Elizabeth, widow, house 66 Franklin
- Fahy James W. 64 State, b. 50 N. St. Paul
- FAHY JOHN & CO.** millinery and fancy goods, 64 State, h. 38 East av.—*See page 545*
- Fahy Margaret, deceased January 25, 1876
- Fahy Martin, saloon, 66 Exchange, house do.
- Fahy Patrick, market, 26 Mumford, house 66 Franklin [lin, h. 340 W. Main
- Fahy Thomas, blacksmith, North c. Frank-
- Fahy Timothy, marble cutter, b. 159 Lake av.
- Failing Tunis P. gatetender, b. 29 Campbell
- Failing William, house 29 Campbell
- Failing William, cutter, 75 N. Water, bds. 29 Campbell [318 State
- Fairchild Andrew, millwright, 127 Mill, h.
- Fairchild Edwin W. house 11 Gardiner park
- Fairchild Harrison S. broker, 59 Powers' buildings, house 34 Atkinson
- Fairchild Harry A. boards 8 Phelps avenue
- Fairchild Henry L. removed to California
- Fairchild Jas. W. removed to E. Bloomfield
- Fairchild Mary E. Mrs. h. 13 Johnston blk.
- Fairchild Myron S. flour and feed, 126 Lake avenue, h. 6 Phelps av.
- Fairchild Olive Mrs, house 8 Phelps avenue
- Fairchild William, carriage maker, boards 12 Swan
- Fairfield Clara A. widow, b. 84 Fitzhugh
- Fairman David, bookkeeper, 24 State, house 8 Reynolds [8 Reynolds
- Fairman Harry M. student, 41 State, boards
- Faist Joseph, lampmaker, Mill c. Furnace, house 104 Orange
- Faist Magdalena, widow, house 102 Orange
- Fake John J. teamster, h. Rapids road near Genesee
- Falck George, laborer, boards 82 St. Joseph
- Falconer Alexander, laborer, h. 11 Vincent place [Brown, h. 2 Smith
- Falconer William, maltster, Warehouse cor.
- Falkenstein Frederick, machinist, 179 N. St. Paul, boards 17 Galusha
- Faller Emelia, widow, boards 69 N. Clinton
- Fallis Jacob, laborer, house Lewis n. Meigs
- Fallon James, laborer, house 2 Cliff
- Fallon William, brushmaker, boards 2 Cliff
- Falls Adaline Miss, boards 43 William
- Falls Jacob, foreman, gas house, h. 78 Ontario
- Falls Judith, deceased May 14, 1876
- Falls Kate A. teacher, private school, 12 Mathews, house do.
- Falls Mary A. widow, house 17 Alexander
- Falls Robert, filegrinder, boards 3 Cliff
- Falls William S. job printer, 9 Elwood blk, house 15 Franklin
- Fanning Bridget, widow, h. Fairmount near University avenue
- Fanning Francis, clerk, boards 3 Myrtle
- Fanning James H. clerk, boards 3 Myrtle
- Fanning John, laborer, house 3 Myrtle

- Fanning J. Rowe (*Fanning & Williams*), 86 Powers' buildings, boards 25 Prince
- Fanning & Williams (*J. R. Fanning and C. M. Williams*), lawyers, 86 Powers' bldgs.
- Fanson Thomas A. house 10 South St. Paul
- Faragher James, carpenter, house 19 Cady
- Farber George J. grocer, North av. c. Caspar, house do.
- Farber John P. agent, house 78 North avenue
- Farber Mary, widow, boards 4 Delevan
- Farley Augustus S. shoemaker, 15 Mill, bds. York House
- Farley Bridget, domestic, Osburn House
- Farley Charles, tailor, house 119 Tremont
- Farley Edward, boatman, boards 43 Stone
- Farley Ellen, widow, house 43 Stone
- Farley, Ferguson & Wilson (*J. Farley, jr. A. Ferguson and D. C. Wilson*), millers, Whitney mills, Mill foot Brown
- Farley James, packer, 205 Plymouth av. h. Reynolds near Strong
- Farley James, boatman, house 10 Prospect
- Farley John (*Farley & Love*), house 227 Plymouth avenue
- Farley John, teamster, house 44 Hunter
- Farley John H. cabinetmaker, house 227 Plymouth avenue [h. 2½ Tremont
- Farley Joseph jr. (*Farley, Ferguson & Wilson*), Farley Joseph, h. Mt. Hope av. n. Cemetery
- Farley Kate Miss, nurse, h. 4 University av.
- Farley Katharine, tailoress, h. Averell n. Cobb
- Farley Margaret, stitcher, boards 26 Centre
- Farley Margaret Miss, stitcher, b. 37 Kent al.
- Farley Michael, laborer, gas works, house 45 Strong
- Farley Philip, farmer, h. 48 Saratoga avenue
- Farley Susanna, dressmaker, b. 48 Saratoga avenue [saloon, 32 South St. Paul
- Farley & Love (*J. Farley and E. H. Love*), Farmer Wm. clerk, 65 E. Main, house 60 Franklin
- Farnham Edwin P. student, Roch. Theological Seminary, bds. 15 Chestnut
- Farnham Seth T. student, Roch. Theological Seminary, boards Trevor Hall
- Farnkopf Vincent, student, Roch. Theological Seminary, boards 118 Alexander
- Farquhar Henry T. saloon, 224 West Main, house do.
- Farquharson Duncan S. millwright, pulp mills, North St. Paul, middle falls, h. 47 Thompson
- Farquharson Duncan jr. millwright, wood pulp mills, North St. Paul, middle falls, boards 47 Thompson
- Farquharson William, pulp maker, North St. Paul, middle falls, b. 47 Thompson
- Farrall Ann, widow, house 42 Atkinson
- Farrand William H. bookkeeper, East Side Savings Bank, East Main corner North Clinton, house 60 Andrews
- Farrar Elizabeth Miss, b. 62 Lake avenue
- Farrar George. tailor, house 194 Jay
- Farrar Lysander, lawyer, 14 State, house 62 Lake avenue
- Farrar Raleigh, student, b. 62 Lake avenue
- Farrel Mary, nurse, boards 19 Arnold park
- Farrell Catharine, widow, boards 14 Ontario
- Farrell Edward, driver, 73 State, bds. West avenue near Ames
- Farrell James H. boards 17 South avenue
- Farrell Jessie, seamstress, boards 33 Stillson
- Farrell Margaret Mrs. milliner, h. 17 South av.
- Farrell Michael, laborer, h. 89 South St. Paul
- Farrell Michael J. grocer, Plymouth av. cor. Bartlett, house 59 Bartlett
- Farrell William, laborer, bds. 114 North av.
- Farrell William A. engineer, house 26 South
- Farren Michael J. grocer, house 59 Bartlett
- Farrington Horace M. salesman, 64 State, house 246 Plymouth avenue
- Farthing John, agent, boards 17 Caroline
- Farthing Lizzie S. tailoress, bds. 17 Caroline
- Farthing Margaret, widow, house 17 Caroline
- Farwell Minnie, milliner, boards 5 Jones
- Farwick John, peddler, h. West Maple near city line [Clinton
- Fassott John, tailor, boards 297 North
- Faul Anton, laborer, house 32 Orange
- Faulkner Charles E. real estate, boards 28 North avenue [house do.
- Faulkner Lewis K. physician, 28 North av.
- Faulstich Elizabeth T. tailoress, boards 121 Hudson
- Faulstich John, teamster, house 121 Hudson
- Faulstich John jr. shoemaker, 87 N. Water, b. 121 Hudson [b. 121 Hudson
- Faulstich Joseph, shoemaker, 75 N. Water,
- Faulstich Mary, tailoress, bds. 121 Hudson
- Faust Elizabeth, seamstress, house 61 Smith
- Faust George, painter, house 61 Smith
- Faust Jacob, painter, boards 61 Smith
- Faust John, laborer, house 58 Oakman
- Faust Joseph, painter, h. Orchard c. Smith
- Faust Leonard, painter, boards 61 Smith
- Favreau Alphonse (*Forest & Favreau*), house 2 Amity
- Fawcett Anthony, house 10 Walnut
- Fawcett Belle C. teacher music and wax flowers, 12 Spencer, boards do.
- Fawcett Fanny, seamstress, bds. 10 Walnut
- Fawcett Samuel, blacksmith, Mill cor. Factory, house 12 Spencer
- Fay Avery H. & Co. (*John K. Hunt*), bluing manufs. 14 N. Water, b. 60 Charlotte
- Fay Catharine, widow, boards 143 Lyell
- Fay Edward, waiter, Front c. West Main, boards do.
- Fay Edward, paper maker, b. Mill c. Platt
- Fay Elizabeth, widow, house 5 Kent
- Fay Frank, brakeman, boards 4 Saxton
- Fay Frank D. cigarmaker, 45 E. Main, bds. 20 Ames [Clinton Hotel
- Fay Henry C. salesman, 39 Exchange, bds.
- Fay Jackson S. clerk, 14 N. Water, house 60 Charlotte [Charlotte
- Fay Jay, draughtsman, 55 Arcade, bds. 60
- Fay Jay J. carpenter, boards 11 Mathews
- Fay John D. 57 Fitzhugh, house 22 South Washington
- Fay John J. laborer, house 13 Hill
- Fay John L. machinist, Exchange opposite Glasgow, boards 4 Adams
- Fay J. Otis, deceased April 24, 1876
- Fay Patrick, laborer, house Ames cor. R. R.
- Fay Rebecca B. Miss, house 11 Mathews

- Fay Sarah A. Miss, seamstress, bds. 13 West Troup
- Fay Thomas, blacksmith, house 240 State
- Fay William, clerk, 37 State, h. 14 Emerson
- Fay Wm. trackman, boards 162 North av.
- Fay William J. laborer, house 72 Broadway
- Fay, see Fey, Feye and Fahy
- Fayette Henry, porter, at Osburn House
- Fayle Susan, widow, house 44 Gorham
- Fayle Thomas W. mason, boards 44 Gorham
- Feagean Lizzie, dressmaker, 249 State, h. do.
- Feagean Mary, dressmaker, boards 249 State
- Feagles Adaline, widow, house 53 Jay
- Fearren John, laborer, b. 317 N. St. Paul
- Feasler Anna M. deceased, Sept. 1875
- Feasler Joseph, machinist, h. 161 N. Clinton
- Feasler Wm. J. shoemaker, 15 Mill, house 9 Hudson [55 Andrews
- Fechenbach Abraham, clerk, 11 State, bds.
- Fechenbach Louis, 24 Front, h. 51 Monroe av.
- Fechenbach Sophia, millinery, 51 Monroe av. house do.
- Fechuer Emelia, widow, h. 85 Monroe av.
- Fechner Ernst C. printer, boards 18 Allen
- Fechner Julius C. butcher, Herman corner Thomas, boards 42 Herman [Frost av.
- Fechter Joseph A. blacksmith, 129 Mill, h. 70
- Fee James & Bros. (*O. F. and J. C. Fee*), liquors, 26 N. Water, h. 102 N. St. Paul
- Fee John C. (*James Fee & Bros.*), boards 102 North St. Paul [N. St. Paul
- Fee Joseph H. clerk, 26 N. Water, bds. 102
- Fee Margaret, widow, house 102 N. St. Paul
- Fee Owen F. (*James Fee & Bros.*), bds. 102 North St. Paul [W. Main
- Feehery Johanna (*Feehery & Heberling*), h. 222
- Feehery Patrick, boards 222 West Main
- Feehery & Heberling (*J. Feehery and Wm. Heberling*), grocers, 222 West Main
- Feely Dennis C. lawyer, 83 Powers' buildings, house 18 Rowe [ton av.
- Feely Lawrence, chairmaker, house 132 Ful-
- Feely Margaret, widow, boards 16 Catharine
- Feeney Andrew, laborer, house 20 White
- Feeney Edwin F. carriage finisher, boards 84 Troup
- Feeney Frank P. painter, house 17 S. Ford
- Feeney John, nailmaker, 5 Spring, boards 17 Martin
- Feeney Josephine, forewoman, bds. 132 Oak
- Feeney Mary R. dressmaker, boards 132 Oak
- Feeney Michael, laborer, house 132 Oak
- Fegan Peter, laborer, 124 Mill, h. Sherman
- Fegan Thomas, teamster, house Orchard n. N. Y. C. R. R.
- Fehrenbach Frank, carpenter, Walnut near Campbell, b. Childs c. Smith
- Fehrenbach John, machinist, Brown corner Jones, house 152 Jay
- Feif Barbara, widow, boards 74 Gregory
- Feinburg Louis, peddler, house 67 Herman
- Feiock Bernard, bookkeeper, 9 Atwater, b. 6 St. Joseph [Clifford
- Feiock George, shoemaker, 55 Mill, house 14
- Feiock Michael, laborer, house 8 Atwater
- Feioch Sarah, widow, boards 6 St. Joseph
- Feiser Mary, widow, house Elm near Bay
- Feiser Nicholas, deceased June 5, 1875
- Feiser William, laborer, boards Jennings n. Goodman [b. 69 West Maple
- Feist Christopher, shoemaker, 6 N. Water,
- Feist George, tanner, house 69 W. Maple
- Feist Michael, shoemaker, bds. 69 W. Maple
- Feit Frank, hairdresser, 5 Arcade, house 247 Exchange
- Fell Myer, peddler, house 71 Nassau
- Felce Herman, brewer, house 10 Galusha
- Feldhoff Emily Miss, boards 1 Anson park
- Feldhoff Louisa, deceased May, 1875 [Weld
- Feldt Frederick, porter, 72 East Main, h. 71
- Felger Edward, removed to Ohio
- Felix Albert, cooper, boards 34 West Maple
- Felix Francis X. cooper, bds. 34 W. Maple
- Felix Joseph, conveyancer, 90 W. Main, bds. 34 West Maple
- Felix Theresa, widow, house 34 West Maple
- FELL ABRAHAM**, agent, Blue line freight, 166 State, house 1 Ambrose.—*See railroads in contents*
- Fell Fred. A. clerk, 166 State, b. 1 Ambrose
- Fell George, house 149 Tremont [Campbell
- Fell George B. tailor, 79 State, house 30
- Fell John A. saloon, Water c. railroad, house 1 Emmett [Ambrose
- Fell Thomas R. machinist, 138 Mill, boards 1
- Fellers Margaret, bds. East av. c. Alexander
- Fellman Ellis, moulder, 187 W. Main, h. 37 Childs [W. Troup
- Fellman John, moulder, 145 N. Water, b. 9
- Fellman Louis, moulder, 187 W. Main, h. 101 Wilder
- Fellman Mary A. widow, house 9 W. Troup
- Fellman Philip, blacksmith, 5 Spring, boards 49 Joiner
- Felltenstein Jacob, cigarette maker, 55 S. St. Paul, boards 9 Griffith
- Felsenheimer William, painter, house Lincoln near Clifford
- Fels August, carpenter, bds. 150 S. St. Paul
- Fels Joseph, machinist, bds. 150 S. St. Paul
- Felsing Anthony, house 31 Orange
- Felsing John A. (*Kaufman & Felsing*), 170 W. Main, boards 31 Orange
- Felt Carrie M. telegraph operator, 151 State, boards 58 Frank [93½ do.
- Felt Jehiel R. pumpmaker, 91 East av. h.
- Feltz Eugene, sausagemaker, 52 Front, b. do.
- Feltz Felix, butcher, 77 East av. b. 32 Scio
- Fender James, machinist, house 3 Vernon
- Fender Peter B. clerk, house 34 Hunter
- Fenlon John, steward, boards 11 S. Ford
- Fenn Charles H. clerk, boards 9 Centre pk.
- Fenn Frank C. bookkeeper, City Bank, 34 State, b. 9 Centre pk. [9 Centre pk.
- Fenn Fred. S. bookkeeper, 107 State, boards
- Fenn Harvey C. furniture dealer, 107 State, house 9 Centre park
- Fenn Henrietta E. widow, h. 9 Livingston pl.
- Fenn Robert H. boards 9 Livingston place
- Fenn William W. salesman, 107 State, bds. 9 Centre park
- Fennel Michael, carpenter, house 7 Prince
- Fenner Albert J. salesman, house 16 Pine-nacle avenue
- Fenner Alger, carpenter, h. Bismarc near Genesee

Fenner Edward B. lawyer, 2 Baker's block, h. 98 Mt. Hope av.
 Fenner Edward V. bartender, 116 W. Main, boards do. [No. 9, b.5 Atwater
 Fenner Emily J. teacher, Andrews School,
 Fenner Frances, widow, house 11 Charlotte
 Fenner Frank P. salesman, boards 16 North Washington
 Fenner Oren L. deceased October 1875
 Fenner Owen, boards 11 Charlotte
 Fenner Sarah J. widow, bds. 13 Briggs pl.
 Fenton Alfred, engineer, N. Y. C. R. R. h. 43 Ambrose [Charlotte
 Fenton William H. clerk, 50 Front, house 38
 Fenwick Thomas, tanner, 44 North Water, h. Conkey avenue corner Avenue C
 Ferbeck Bernard, cooper, Magne opp. Walnut, house Childs near Jay
 Ferbeck Henry, porter, 66 Mill, h. 101 Childs
 Ferge Annie, widow, boards 29 Sanford
 Ferge George, laborer, house Henrietta av. corner Allmeroth [Henrietta av.
 Ferge Henry, mason, house Allmeroth near
 Ferguson Annie J. (Taft & Ferguson), 58 State, boards 9 Waverley place
 Ferguson Alexander (Farley, Ferguson & Wilson), Mill foot Brown, h. 60 Platt
 Ferguson Duncan, millwright, house 47 Thompson
 Ferguson Duncan jr. pulpmaker, boards 47 Thompson
 Ferguson Edwin, whipmaker, Allen corner N. Washington, boards 12 Ambrose
 Ferguson James, laborer, house 324 State
 Ferguson Jefferson J. agent, bds. 9 Waverley place [Platt
 Ferguson John, miller, 5 Aqueduct, bds. 60
 Ferguson Junius H. clerk, Allen cor. North Washington, boards 11 Lyell
 Ferguson Maggie E. clerk, bds. 7 Manhattan
 Ferguson Martha W. widow, house 4 King
 Ferguson Mary, housekeeper, East av. near Meigs [91 Atkinson
 Ferguson Mary Miss, 205 Plymouth av. bds.
 Ferguson Nancy, widow, h. 9 Waverley place
 Ferguson Sarah A. widow, h. 133 Plymouth av.
 Ferguson Thomas, frame maker, bds. 174 Exchange
 Ferguson Thomas, cartman, h. 91 Atkinson
 Ferguson Thomas, watchman, Exchange opp. Glasgow, boards 101 Tremont
 Ferguson Wm. pulpmaker, b. 47 Thompson
 Ferguson William, house 174 Exchange
 Ferguson Wm. B. miller, Whitney Mills, b. 60 Platt [Rowe
 Ferguson Wm. G. carpenter, h. Finch near
 Ferguson Wm. H. whipmaker, Allen near N. Washington, house 12 Ambrose
 Fergusson Wesley A. removed from city
 Fernaays Stephen, melter, 150 North Water, house St. Joseph near Norton
 Ferner Charles L. removed to Syracuse
 Ferner Charles P. marble cutter, boards 138 Lake avenue
 Ferner John, grocer, 138 Lake av. house do.
 Ferner John jr. clerk, 138 Lake av. bds. do.
 Ferner Leonard, grocer, 204 North, h. do.
 Ferner Sophia, widow, house 15 Swan

Ferner Sophia, stitcher, boards 15 Swan
 Ferner Theodore, carver, boards 15 Swan
 Ferreira Margaret M. widow, h. 31 Upton pk.
 Ferren A. Kimball, clerk, boards-19 Asylum
 Ferren Joseph, laborer, rear 204 State, house 26 Brown's alley
 Ferren Thad. scalemaker, boards 19 Asylum
 Ferris Christopher, boards 121½ East Main
 Ferris Lillias E. milliner, boards 13 Pearl
 Ferris Robert, laborer, house 60 Martin
 Ferster Benedict, combmaker, house 13 Vose
 Ferster Frederick S. compositor, 3 W. Main, boards Lake av. opp. Little Ridge road
 Ferster James H. compositor, 3 W. Main, h. Lake av. opp. Little Ridge road
 Fertig John. flour and grain, 135 N. Clinton, house do.
 Fertig Lewis, surveyor, house 23 Baden
 Fetterly Aaron, clerk, Clinton Hotel, house 112 Orchard [bds. 66 Atwater
 Fetzer Frank A. salesman, 73 East Main,
 Fetzer George, student, Rochester Theological Seminary, boards Trevor Hall
 Fetzer John J. salesman, 53 East Main, house 66 Atwater [h. 4 Marietta
 Feuchtinger George, printer, 149 N. Water.
 Feuchtinger George jr. publisher Von Nah und Fern, 149 N. Water, b. 4 Marietta
 Feuel Katie, waiter, Whitcomb House
 Few William W. removed to St. Louis, Mo.
 Fey Stephen V. shoemaker, house 29 Sanford
 Feye Frederick, shoemaker, 92 State, house 66 St. Joseph [h. do.
 Fichtmaier Geo. mason, 311 North Clinton,
 Fichtner August, auger maker, b. 20 Tyler
 Fichtner David E. baker, 158 North avenue, house do. [158 North av.
 Fichtner David G. clerk, 27 Arcade, boards
 Fichtner Frederick, auger maker, h. 20 Tyler
 Fichtner Jacob, moulder, 150 N. Water, bds. 158 North avenue
 Fickett Albert, well driller, h. 52 Atwater
 Fickett Franklin, well driller, house 174 Exchange
 Fickett Sarah, widow, h. 120 Caledonia av.
 Fickett Wm. S. detective, City Hall, house 120 Caledonia avenue
 Fidelis Sister, teacher, boards Jay cor. Frank
 Fiedler Catharine, widow, boards Thorn cor. McCracken [c. McCracken
 Fiedler Moritz, machine operator, h. Thorn
 Field Anna, domestic, boards East av. near Goodman
 Field Charles L. clerk, 1 East park, house 54 North Union [Grape
 Field Francis S. wire weaver, 79 State, h. 45
 Field George E. 42 Exchange, h. 23 Greig
FIELD JAMES, awnings, tents and cordage, 42 Exchange, house 27 Greig.—See page 648
 Field Jane, domestic, b. East av. opp. Meigs
 Field John B. laborer, house 96 Bartlett
 Field Joseph, house 88 Fitzhugh
 Field Mary A. dressmaker, boards 19 Olean
 Field Patrick, mason, boards 96 Bartlett
 Field Patrick, laborer, house 19 Olean
 Fien Alexander, carpenter, 14 St. Joseph, h. 18 McDonald avenue

Fien Bernard, wagonmaker, h. 50 Scramton
 Fien John, file cutter, River near N. Water,
 house 69 Whitney
 Fien Louis, grocer, 192 N. Clinton, house do.
 Fien Louisa, seamstress, boards 50 Scramton
 Fien Margaret, widow, house 267 N. Clinton
 Fierstein Benedict, tailor, boards West Ma-
 ple corner Tonawanda
 Fiesler J. Peter, bakery, 51 Grape, h. do.
 Fifield Caroline, removed to Michigan
 Figer Sebastian, laborer, h. Goodman n. Bay
 Fight Catharine, widow, boards 108 Saxton
 Filer George R. clerk, 53 E. Main, h. 8 James
 Filiatroult Albert, driver, 63 Plymouth av.
 house 1 Eagle
 Filkins Constant F. (*Filkins & Winterroth*),
 14 Powers' buildings, house 48 Clifton
 Filkins & Winterroth (*C. F. Filkins and A.*
Winterroth), hair dressers, 14 Powers'
 buildings
 Filon Michael, house 13 North Clinton
FINCH CYRENIUS H. ice dealer, 134
 State, h. Rowe n. Erie canal.—*See p.* 571
 Finch Martha A. widow, house 56 Lorimer
 Finch Miranda, widow, b. Rowe cor. Ninth
 Finch Simeon, ice dealer, Rowe near Erie
 canal, boards do.
 Finding Fred. T. teller, Bank of Monroe, 22
 Exchange, house 113 Lake avenue
 Finding Joseph, carpenter, 7 Smith, h. do.
 Finein Edward, cooper, West n. Lyell, house
 41 Thompson
 Finein Mary A. dressmaker, b. 41 Thompson
 Fink Anselm, laborer, house 288 St. Joseph
 Fink Christian, auger filer, house 9 Herman
 Fink Clementine Mrs. house 6 Pearl
 Fink Frederick, laborer, house 32 Cole
 Fink George, boxmaker, Aqueduct, house 66
 Orchard
 Fink Herman, polisher, house 9 Herman
 Fink John, laborer, h. Carter n. North av.
 Fink John, finisher, 38 Gorham, house Cotter
 near city line
 Finkelstein A. C. peddler, h. 57 St. Joseph
 Finkle Charles E. sewing machines, 40 East
 Main, house 123 Caledonia av.
 Finkle Finley, expressman, house 94 Front
 Finkle George W. teamster, h. 70 Munger
 Finkle James, laborer, house 96 Front
 Finley Charles, fireman, 3 Canal, house near
 Thurston road
 Finley Edward J. salesman, boards 63 Jay
 Finley Elizabeth, widow, house 63 Jay
 Finley George A. clerk, 159 State, b. 63 Jay
 Finley Margaret Miss, dressmaker, 24 Hill,
 house do.
 Finley William D. carriage maker, b. 63 Jay
 Finn Maggie, house 4 Smith
 Finn Margaret, domestic, h. 18 Brown's alley
 Finn Patrick, switchman, h. 21 Philander
 Finnance Thomas, boxmaker, boards 112 N.
 Water
 Finnegan Andrew, removed to Spencerport
 Finnegan Charles R. ticket agent, Rochester
 & State Line R. R. Saxton c. Maple, h. do.
 Finnegan Thomas, clerk, bds. 24 Andrews
 Finnermore George, coachman, 64 Fitzhugh,
 boards 26 Spring

Finnican Clara, milliner, bds. 4 Oregon
 Finnican Thomas J. clerk, 23 East Main, b.
 24 Andrews
 Finnigan Alice, domestic, b. East av. near
 Goodman
 Finnigan Peter, laborer, house 50 Bartlett
 Finucane James, bricklayer, h. 112 N. Water
 Finzer Anthony, cutter, 64 Mill, house 83 St.
 Joseph
 Finzer Charles, blacksmith, h. 8 Hanover
 Finzer Frank V. (*Finzer & Zarges*), 13 South
 Water, house 6 Hanover
 Finzer John, bricklayer, boards 7 Vienna
 Finzer John E. cigar manuf. 70 St. Joseph,
 house 99 Chatham
 Finzer John F. stonecutter, house 7 Vienna
 Finzer Martin F. hairdresser, Congress Hall,
 house 154 N. Clinton
 Finzer Valentine, grocer, 99 Chatham, h. do.
FINZER & ZARGES (*F. V. Finzer and O.*
Zarges), millwrights and water wheel
 dealers, 13 S. Water.—*See page* 676
 Fiock George, shoemaker, house 14 Clifford
 Fiock Joanna, silver layer, bds. 14 Clifford
 Fiock John, cigarmaker, bds. 14 Clifford
 Fiock see Feiock and Feioch
 Firman Warren S. (*Welch & Firman*), 12
 Smith's blk. house 34 North Union
 Fischer J. Mrs. boards 25 Oregon
 Fischer Adam G. shoemaker, h. 43 Hanover
 Fischer August, machinist, h. 40 Hanover
 Fischer Barbara, carpet weaver, 101 Camp-
 bell, house do.
 Fischer Charles, spinner, house 79 Orange
 Fischer Conrad, deceased Aug. 23, 1875
 Fischer Frank, upholsterer, 15 N. Water, b.
 33 Hollister
 Fischer Frederick, turner, h. 267 St. Joseph
 Fischer Frederick, shoemaker, 109 ½ Jay,
 boards do.
 Fischer George, machinist, bds. Hague
 Fischer George, cabinet maker, Hydraulic
 buildings, house 27 Holland
 Fischer George, varnisher, bds. 79 Orange
 Fischer George A. carpet weaver, bds. 101
 Campbell
 Fischer George J. cutter, house 90 Campbell
 Fischer Henry, cabinetmaker, Hydraulic
 buildings, bds. 27 Holland
 Fischer John, wheelwright, 3 Elizabeth, bds.
 267 St. Joseph
 Fischer John, laborer, boards 109½ Jay
 Fischer John, finisher, house 108 Campbell
 Fischer John, market, 115 Lyell, house do.
 Fischer John A. weaver, house 104 Chatham
 Fischer John M. shoemaker, 109½ Jay, h. do.
 Fischer Joseph, carpenter, house Lewis
 Fischer Joseph, blacksmith, 35 S. St. Paul,
 boards 91 Front
 Fischer Joseph, cigarmaker, h. 21 Herman
 Fischer Margaret, widow, boards 1 Amity
 Fischer Michael, blacksmith, Brown corner
 Jones, h. Hague n. West av.
 Fischer Veronica, widow, h. 33 Hollister
 Fischer Wendlin (*Segewitz & Fischer*), 132 E
 Main, house 20½ Stone
 Fischer Wm. bootfitter, bds. 108 Campbell
 Fischer William, carpenter, house 9 Nassau

- Fischer, see Fisher [19 Elm
 Fish Geo. T. nursery stock, 35 Arcade, bds.
 Fish Harriet L. widow, boards 6 Cypress
 Fish Henry L. (*Fish & Heath*), house 100
 West avenue
 Fish Julia Mrs. widow, house 4 Jay
 Fish Rollin H. house 22 Tremont
 Fish & Heath (*H. L. Fish and E. Heath*),
 transportation, Fitzhugh cor. Erie canal
 Fisher Andrew, peddler, house 39 Hanover
 Fisher Bernard, removed to Iowa
 Fisher Christian, laborer, house 3 Scantom
 Fisher Charles, gardener, house Goodman n.
 Park avenue [Park av.
 Fisher Charles jr. florist, bds. Goodman near
 Fisher David L. Mrs. boards 69 Cady
 Fisher Edward, laborer, house 14 Mark
 Fisher Elizabeth, widow, h. rear 20½ Stone
 Fisher Frank, farmer, boards 160 State
 Fisher Frederick S. clerk, 60 State, h. 135
 Adams n. Frances [74 Asylum
 Fisher George, shipping clerk, 88 State, h.
 Fisher George, grocer, 110 East Main, house
 18 University avenue
 Fisher George E. treas. Roch. Adamantine
 Brick Co. 5 Masonic block
 Fisher George W. house 11 Troup
 Fisher Harriet, widow, house 54 Atkinson
 Fisher Harriet, peddler, house 10 Holland
 Fisher Henry, tailor, house 230 Pinnacle av.
 Fisher Henry, farmer, house 160 State
 Fisher Jacob, deceased April 13, 1876
 Fisher James, clerk, 2 Hudson, h. 11 Wilson
 Fisher Jane Mrs. nurse, City Hospital, b. do.
 Fisher John, clerk, b. Goodman n. Park av.
 Fisher John, teamster, Clarissa opp. Ex-
 change, house 70 South avenue
 Fisher John J. salesman, house 3 Lincoln
 Fisher John M. shoemaker, 87 N. Water, h.
 42 North Clinton
 Fisher John M. laborer, house 27 Hudson
 Fisher John W. laborer, house 76 Hudson
 Fisher J. Napoleon, shoemaker, house 31
 Lancaster [do.
 Fisher Kate N. Mrs. dressmaker, 33 Scio, h.
 Fisher Margaret, widow, boards 34 Martin
 Fisher Martin W. painter, house 7 Wilson
 Fisher Nathan, entry clerk, 40 State, bds. 1
 South
 Fisher Otto (*Knapp & Fisher*), Falls Field, N.
 St. Paul, n. Ward, h. 103 N. St. Paul
 Fisher Peter, tinsmith, house 506 Brown
 Fisher Philip, shoemaker, 124 Front, house 62
 Cypress
 Fisher Samuel, laborer, house 108 Champlain
 Fisher Sarah M. Mrs. house 160 State
 Fisher Theodore, salesman, house 34 Martin
 Fisher Thomas, painter, house 7 Leopold
 Fisher ———, clerk, 76 State, boards 34
 South Washington
 Fisher see Fischer [Broadway
 Fisk Daniel D. carriage trimmer, house 58
 Fisk John M. house 26 South Clinton
 Fisk Luther E. hay dealer, ft. White, house
 22 South Ford
 Fiske Asa S. removed to San Francisco, Cal.
 Fiske Edwin B. lawyer, 37 Powers' bldgs. b.
 134 South St. Paul
 Fitch Charles E. managing editor Democrat
 & Chronicle, 3 West Main, h. 14 Adams
 Fitch George W. Mrs. widow, h. 60 Andrews
 Fitch Giles H. paper hanger, h. 68 West av.
 Fitch Henry L. civil engineer, 82 Powers'
 buildings, boards 34 Jay
 Fitch James O. watch maker, Court corner
 Stone, house 209 Monroe avenue
 Fitch Mary, widow, house 16 Chatham
 Fitch William A. salesman, bds. 108 Frank
 Fitchner Frederick, pyrotechnist, boards 307
 East Main [Clifford
 Fitt James, machinist, Clinton Mills, house 26
 Fitts John J. house 15 University avenue
 Fitzenberger Christina, widow, h. 51 Ontario
 Fitzenberger Joseph, chairmaker, lower falls,
 house Fulton avenue c. Brisbane
 Fitzgerald Ann, widow, house r. Stone near
 Allen's alley
 Fitzgerald Catharine, clerk, boards 15 Kelly
 Fitzgerald Christopher, laborer, h. 46 Munger
 Fitzgerald Eliza T. Miss, teacher, Andrews
 School, No. 9, bds. 123 North St. Paul
 Fitzgerald Ellen, packer, boards 18 West
 Fitzgerald James, laborer, house 18 West
 Fitzgerald James jr. laborer, bds. 18 West
 Fitzgerald James C. removed to Auburn
 Fitzgerald John, shoemaker, 35 Smith, h. 34
 Kent
 Fitzgerald John, horse dealer, b. 96 S. St. Paul
 Fitzgerald John, stonecutter, bds. 94 Pearl
 Fitzgerald John P. peddler, h. 52½ Andrews
 Fitzgerald Lucy A. teacher, Andrews School,
 No. 9, boards 123 N. St. Paul
 Fitzgerald Mary, widow, h. 135 S. St. Paul
 Fitzgerald Mary, widow, house 15 Kelly
 Fitzgerald Mary, widow, house 38 St. Joseph
 Fitzgerald Michael, market, 100 North St.
 Paul, boards 123 do.
 Fitzgerald Peter, machinist, house 14 King
 Fitzgerald Richard, shoemaker, 35 Smith, b.
 34 Kent
 Fitzgerald Sarah A. widow, h. 49 Edinburgh
 Fitzgerald Theodore, cigarmaker, house 13
 Montrose
 Fitzgerald Thomas, carpenter, bds. 15 Kelly
 Fitzgerald Thomas, conductor, N. Y. C. R. R.
 house 14 Atwater [N. St. Paul
 Fitzgerald William, quarryman, house 123
 Fitzgerald William, moulder, bds. 15 Kelly
 Fitzgibbon John, shoemaker, h. 63 Troup
 Fitzharris Richard, quarryman, h. Cottage n.
 Genesee
 Fitzpatrick John, laborer, house 11 Syke
 Fitzpatrick John, laborer, house 21 Helena
 Fitzpatrick John, tobacco cutter, 55 South
 St. Paul, boards 17 Woodbury
 Fitzpatrick Michael, removed from city
 Fitzpatrick Michael, laborer, h. 59½ Cypress
 Fitzpatrick Patrick, laborer, bds. 21 Helena
 Fitzpatrick Patrick, laborer, h. 17 Woodbury
 Fitzpatrick Thomas, tobacco cutter, 55 S. St.
 Paul, bds. 17 Woodbury
 Fitzpatrick Thomas, laborer, bds. 21 Helena
 Fitz Simmons Alice, deceased, January, 1876
 Fitz Simmons Anna, widow, b. Clifford n.
 Hudson [Clifford
 Fitz Simmons James, cabinet maker, h. 115

- Fitz Simmons John, coachman, h. Sibley n. Bates
 Fitz Simmons Mary, stitcher, bds. 40 Lyell
 Fitz Simons Alice, widow, house Plymouth avenue near Magnolia
 Fitz Simons Charles (*Burke, Fitz Simons, Hone & Co.*), 53 E. Main, h. 2 Livingston place
 Fitz Simons Mary, boards Plymouth av. n. Magnolia [State, house 170 do.
 Fitz Simons Michael H. slate roofing, 164
 Flad Charles A. tinsmith, 196 E. Main, h. 13 William
 Flad Jacob, tailor, house 17 Tyler
 Flad John U. tailor, house 193 North
 Fladd Elias, tailor, house Bay near Hebard
 Fladd George E. polisher, 179 N. St. Paul, house 57 Bay
 Fladd Godfrey, mason, house 65 Ontario
 Fladd Gottlieb, optician, 179 North St. Paul, house Henry
 Fladd John, fireman, N. Y. C. R. R. house 5 Helena
 Fladd John L. clerk, 78 E. Main, boards 65 Ontario [Monroe av.
 Flager Frank, gardener, boards Bowen near
 Flager William, boards 13 Meigs
 Flagler Barnet B. (*Thos. Wright & Co.*), 167 S. St. Paul, house 7 Park avenue
 Flagler Catharine W. widow, h. 13 Pleasant
 Flaherty Ellen, seamstress, bds. 3 Spencer
 Flaherty John, laborer, house 150 Lyell
 Flaherty Joseph, stavecutter, Lyell cor. Erie canal, house West cor. Jones avenue
 Flaherty Mary, widow, house 3 Spencer
 Flaherty Patrick, tailor, 55 E. Main, house 6 Denning
 Flaherty Richard, hostler, 142 Lake avenue, boards 3 Spencer
 Flake Henry, house 182½ North St. Paul
 Flamm Jacob, farmer, house Elm near Bay
 Flanagan Daniel, laborer, h. rear 20 Griffith
 Flanagan David, finisher, 22 South St. Paul, boards 21 Elm
 Flanagan Kate, widow, boards 53 Manhattan
 Flanagan Martin, grocer, 8 West av. h. do.
 Flanagan Mary, milliner, bds. 121 S. St. Paul
 Flanagan Mary A. Miss, seamstress, house 27 Lancaster
 Flanagan Patrick, laborer, h. 121 S. St. Paul
 Flanagan Rebecca, widow, house 124 Adams
 Flanagan Rose, vestmaker, b. 53 Manhattan
 Flanagan Thomas, laborer, h. 53 Manhattan
 Flanagan Thomas, propr. Enniskillen Hotel, 302 State, house do.
 Flanagan Thomas W. slate roofer, h. 301 State
 Flanagan Wm. laborer, boards 27 Lancaster
 Flanagan William, peddler, 144 East Main
 Flanders Bartlett, house 149½ East Main
 Flanigan Elizabeth B. deceased Jan. 23, 1876
 Flanigan James, laborer, Brown cor. Jones, house 19 Smith
 Flanigan Mary, widow, house 22 Campbell
 Flanigan Michael, teamster, house 26 Cady
 Flanigan Patrick, laborer, house 8 Tyler
 Flanigan Wm. laborer, house 60 Wilder
 Flannery Catharine, widow, house 35 Hill
 Flannery Edward, laborer, boards 35 Hill
 Flannery George F. student, University of Rochester, boards 79 Court
 Flannery Roger, laborer, boards 35 Hill
 Flannery Thomas, foreman, Union news room, 82 West Main, house 79 Court
 Flannery Wm. cashier, 53 E. Main, b. 79 Court
 Flatray Devora, widow, boards 3 Amity
 Flavahin Bridget, widow, h. 29 W. Maple
 Flaven Jane Miss, sewer, boards 45 Chestnut
 Flaven John, laborer, house 29 W. Maple
 Flavihan John, laborer, N. Ford cor. Hill, house 29 West Maple
 Fleck Margaret, widow, boards 23 Wilder
 Fleck Nicholas, cabinetmaker, 184 State, b. 23 Wilder [55 Whitney
 Fleck William, cooper, 5 Thompson, house
FLECKENSTEIN BROS. (J., G. and V. Fleckenstein jr.), steam bakers, Brown cor. W. Maple.—*See page 573*
 Fleckenstein George (*Fleckenstein Bros.*), h. Brown corner West Maple
 Fleckenstein Joseph (*Fleckenstein Bros.*), bds. Brown corner West Maple
 Fleckenstein Otto, mason, house 4 Kondolf
 Fleckenstein Valentine, house 14 East
 Fleckenstein Valentine jr. (*Fleckenstein Bros.*), house 34 Madison
 Flegel Valentine, brakeman, house 12 Syke
 Flegel ———, widow, h. W. Maple n. Hague
 Fleig John G. cabinetmaker, Jay cor. Erie canal, h. 56 Whitney
 Fleischer Henry J. flour and feed, 124 St. Joseph, house do.
 Fleischer Henry P. gilder, b. 124 St. Joseph
 Fleischer Louis, teamster, bds. 124 St. Joseph
 Fleischer Simon, laborer, 13 Warehouse, bds. 31 Rhine
 Fleischhacker Caspar, laborer, h. 1 Holland
 Fleischhauer Geo. cabinet maker, 184 State, house 28 Joiner
 Fleischner Leopold, tailor, house 31 Rhine
 Fleming Ann, house 29 South St. Paul
 Fleming Bridget Miss, boards 11 Hill
 Fleming Edward H. removed to Buffalo
 Fleming Eliza, widow, house 33 Broadway
 Fleming John D. tinsmith, b. 33 Broadway
 Fleming Lorenzo D. confectionery, 27 East Main, house do.
 Fleming Margaret I. widow, h. 207 Exchange
 Fleming Michael, mason, h. 36 Brown's blk.
 Fleming Patrick, machinist, water works, shop City Hall, house 53 North avenue
 Flesch Charles, machinist, Court cor. Stone, house 8 Drayton [8 Drayton
 Flesch Nicholas, machinist, 187 W. Main, b.
 Flesch Philip, machinist, bds. 8 Drayton
 Fletcher Catharine, widow, h. Bowen n. Bates
 Fletcher Charles S. clerk, 57 Fitzhugh, house 119 Pinnacle avenue
 Fletcher Charles jr. lockmaker, Court cor. Stone, house 56 Hamilton place
 Fletcher Edwin, laborer, b. 119 Pinnacle av.
 Fletcher Malcom, shoemaker, 4 Allen, house 6 North Frances
 Fletcher Robert, coachman, boards Bates near Bowen
 Fletcher Thomas C. (*J. W. Van Vechten & Co.*), 35 State, boards 119 Pinnacle avenue

Fletcher Thomas T. foreman, Citizens Gas Co. Vincent place near North St. Paul, p. do. [Paul, b. Whitcomb House
 Fletcher William W. bookkeeper, 15 N. St.
 Flewett James E. removed to Canada
 Flewett Joseph, carpenter, house 2 Scrantom
 Flewett Sarah A. dressmaker, b. 2 Scrantom
 Flewett Sarah E. Mrs. house 111 East Main
 Flieger John, laborer, house Sibley n. Culver
 Fligel John, laborer, house 19 Woodbury
 Fling Syrel D. house 139 Adams
 Flint Charles S. fireman, Erie railway, bds. 164 Exchange
 Flint George, student, bds. 68 South St. Paul
 Flint John, clerk, 153 State, boards West av. near city line
 Flint John E. grocer, 11 North av. h. 12 do.
FLINT JOSEPH, saw manufacturer, 153 State, h. West av. n. city line.—See page 673 [ter, bds. 81 Sibley's block
 Flock Aaron S. student, University of Rochester
 Floesch Anna, boards 10 Harvard
 Floesch Jacob, wagonmaker, 26 Vienna, h. 10 Harvard [10 Harvard
 Floesch Jacob M. surveyor, 57 State, boards
 Flood Bridget, waiter, Whitcomb House
 Flood Catharine, widow, house 18 Spencer
 Flood Dennis, laborer, h. tow path n. Denning
 Flood Dennis, artist, boards 12 Manhattan
 Flood James, shoemaker, bds. 25 Munger
 Flood Patrick, deceased May, 1875
 Flora Alexander, cooper, Butler cor. Charles, house 41 King
 Flora Frank A. carpenter, house 60 Cady
 Flora Frank A. jr. upholsterer, 184 State, bds. 60 Cady
 Flora Joseph W. removed from city
 Florack Christian A. teamster, house Norton near Carter
 Florack Bernard, filer, 8 Hill, h. 36 Hanover
 Florack Frank, clerk, 51 Hudson, b. Norton
 Florack Frank T. carpenter, bds. 16 Grand
 Florack John, machinist, boards 16 Grand
 Florack Joseph, machinist, house 16 Grand
 Florack Josephine, knitter, bds. 18 Grand
 Flory Barbara, widow, house 322 Brown
 Flour City National Bank, 1 Powers' bldgs.
 Flowerday Joseph, teamster, h. 57 Gregory
 Flowerday Joshua R. carpenter, North York near Railroad al. h. do. [Main
 Floyd A. Ward, clerk, 54 State, bds. 169 E.
 Floyd Edward H. painter, house 243 State
 Floyd Elizabeth A. widow, house 123 University avenue
 Floyd Frank M. painter, 16 Stone, boards 123 University av.
 Fluck George, clerk, 21 Exchange place, b. 4 Gorham
 Flucker George, clerk, house 8 Stone
 Flusky James, coachman, house 8 Selden
 Flusky John, hostler, 14 S. Clinton, bds. do.
 Flusky Lawrence E. miller, Washington Mills, boards 8 Smith
 Flusky Robert, laborer, house 47 Savannah
 Flynn Anna M. clerk, 7 E. Main, boards 34 S. Washington
 Flynn Bernard, tool grinder, house 31 Stone
 Flynn Charlotte C. widow, h. 61 Pinnacle av.

Flynn Cornelius H. hallman, House of Refuge, boards do.
 Flynn James, removed to Germantown, Ky.
 Flynn James, tinsmith, boards 74 Adams
 Flynn James (Cowman & Flynn), boards 19 Emerson [h. 59 Orange
 Flynn James P. watchman, House of Refuge,
 Flynn John, fireman, boards 61 Bolivar
 Flynn John, carpenter, house 54 Jay
 Flynn John, laborer, house 15 Tappan
 Flynn John C. boards 59 Orange
 Flynn Joseph, principal St. Mary's school, 15 South, boards 1 do.
 Flynn Katie, cotton weaver, boards 6 Vernon
 Flynn Luke R. clerk, 53 E. Main, boards 59 Orange
 Flynn Mary Ann, widow, h. 87 Pinnacle av.
 Flynn Michael, removed to Germantown, Ky.
 Flynn Michael, farmer, h. Field n. Monroe av.
 Flynn Michael, boilermaker, house 6 Vernon
 Flynn Michael L. agent, house 87 Saxton
 Flynn Myles, saloon, 127 W. Main, bds. 62 Exchange [roe avenue
 Flynn Patrick, laborer, boards Field n. Mon-
 Flynn Patrick, laborer, bds. 12 Savannah
 Flynn Wm. teamster, boards Field n. Mon-roe avenue
 Foehner Geo. grocer, Lime c. Orchard, h. do.
 Foehner John C. foreman, 25 Mill, house 81½ Joiner [N. Clinton c. Atwater
 Foehner Joseph R. trimmer, 25 Mill, house
 Foehner Valentine G. (Foehner & Maier), 4 N. Clinton, h. 11 Weld
FOEHNER & MAIER (V. G. Foehner and L. W. Maier), undertakers, 4 North Clinton.—See page 568
 Foery Andrew, laborer, house 6 Maria
 Foery Frank, hairdresser, 106 N. Clinton, b. 6 Maria [bds. 6 Maria
 Foery Magdalena Miss, tailorress, 48 Martin
 Fogarty Bertha, widow, house 5 Kent alley
 Fogarty John, foreman, house 69 Charlotte
 Fogarty William, framemaker, h. r. 22 Bolivar [5 Kent alley
 Fogerty Frank P. chairfinisher, 184 State, b.
 Fogerty John, mason, boards 21 Jones
 Fogerty John J. varnisher, bds. 5 Kent alley
 Fogerty Patrick, laborer, house 15 Saxton
 Fogerty Patrick, jr. painter, 3 Canal, bds. 15 Saxton
 Foley Alice, boarding house, 34 Oak
 Foley Daniel, yardman, Clarissa opp. Exchange, bds. 42 Frost avenue
 Foley James, switchman, house 21 Orchard
 Foley James, laborer, h. 16 North avenue
 Foley Johanna, domestic, 77 Lake avenue
 Foley Johanna, widow, house 72 Orchard
 Foley John H. foreman, Clarissa opp. Exchange, house 42 Frost avenue
 Foley Thomas, yardman, Clarissa opp. Exchange, boards 42 Frost avenue
 Foley William, deceased Nov. 28, 1875
 Foley Wm. E. machinist, Brown cor. Jones, boards Eric cor. Oak [house do.
 Follet Harrison, medicine manuf. 114 State,
 Follett Algernon P. moulder, h. 75 E. Main
 Follett Clara B. Mrs. dressmaker, 75 E. Main, house do.

Follett Edward P. agent, house 5 Augusta
 Follmer Henry, watchman, Charlotte junction, house Ames near Jay
 Folmer Maggie, deceased April 9th, 1876
 Folmer Maggie, widow, h. Ames n. Campbell [house 24 Pryor
 Folsom Frank D. shoemaker, 83 N. Water,
 Fonda Jacob, house 14 Fitzhugh
 Foons Angelos, carpenter, house 97 Saxton
F OOS JOHN, ice dealer, 126 Lyell, house
 F Sixth n. Emerson.—See page 571
 Foons Joseph, laborer, h. Eighth n. Emerson
 Foons Peter, carpenter, h. Bernard n. Hudson
 Foote Albert W. pattern fitter, 187 W. Main,
 house 28 Caledonia av.
 Foote Avery L. removed to Parma
 Foote Celia B. widow, h. 87 Plymouth av.
 Foote Henry, laborer, house Jay n. Ames
 Foote Ira, house 1 Canal [N. Clinton
 Foote Israel, rector, St. Paul's church, h. 37
 Foote John, porter, 91 State
 Foote John C. boards 30 Caledonia avenue
 Foote Luther R. shoecutter, 4 Allen, boards
 87 Plymouth avenue [Meigs
 Foote Nathaniel jr. lawyer, 25 Arcade, h. 19
 Foote Orlando K. removed to Morrisville
 Forbes Addison, architect, 12 Masonic block,
 boards 18 Tremont
 Forbes Charles, physician, 18 Tremont, b. do.
 Forbes David, laborer, boards 59 Lancaster
 Forbes Elizabeth, domestic, 9 Phelps av.
 Forbes James, tinsmith, 26 South St. Paul,
 house 23 Lancaster [12 Vincent pl.
 Forbes John, shoemaker, 87 N. Water, bds.
 Forbes John, house 32 Andrews
 Forbes John N. constable, h. 54 Monroe av.
 Forbes Julia, widow, h. r. Stone n. Allen's
 alley
 Forbes Margaret, widow, house 59 Lancaster
 Forbes Martin, laborer, boards 59 Lancaster
 Forbes Steuben S. & Son (*V. E. Forbes*),
 coal, 11 Hunter, h. 18 Tremont
 Forbes Victor E. (*S. S. Forbes & Son*), boards
 6 Clarissa
 Force Isaiah F. truss hoops, rear 62 East av.
 and (*Haseltine, Cowen & Co.*), house 62
 East avenue
 Ford Abby, widow, boards 154 West avenue
 Ford Anna, widow, house 2 Gregory
 Ford Edward, carriagemaker, 3 Elizabeth,
 boards 12 Elizabeth [b. 169 do
 Ford Frank S. photo-copying, 45 East Main,
 Ford George, saloon, 131 State, house do.
 Ford George M. blacksmith, 109 Mt. Hope
 avenue, house 107 do.
 Ford John, laborer, house 88 Broadway
 Ford John S. bookkeeper, 33 State, house 19
 Prospect [Goodman
 Ford Joseph, coachman, b. East avenue c.
 Ford Mary N. domestic, boards 28 Pearl
 Ford Michael, laborer, house 8 German
 Ford Phineas, watches, &c. 146 State, house
 54 Lake avenue
 Ford Thomas W. foreman, Exchange oppo-
 site Glasgow, house 227 Exchange
 Forde Eva Miss, boards 8 Joslyn park
 Fordham Arthur, feeder, 82 West Main, bds.
 47 Tyler

Fordham Robert, laborer, house 47 Tyler
 Fordyce Horton (*Myles & Fordyce*), 146½
 West Main, house do. [h. 40 S. Union
 Forest Camille, confectioner, 137 East Main,
 Forest Francis, shoemaker, 73 N. Water, h.
 4 Oakman [Monroe av.
 Forest Isaac (*Forest & Favreau*), house 36
 Forest John B. shoemaker, 4 Allen, house 56
 Thompson [5 Henry
 Forest Joseph, shoemaker, 7 S. St. Paul, h.
 Forest Louis, shoemaker, house 6 Oakman
 Forest Maria, domestic, 13 Jones
 Forest Nazaire, shoemaker, 4 Allen, h. 80 Jay
 Forest Oliver, shoemaker, house Thomas n.
 Clifford [saloon, 138 State
 Forest & Favreau (*I. Forest and A. Favreau*),
 Forest, see Forrest [West Main
 Forgie John, cutter, 8 West Main, b. 170½
 Forkel Christopher W. artist, 174 Powers'
 buildings, boards 15 Leopold
 Forkel J. Christian, saloon, South St. Paul
 corner East Main, house 17 Rome
 Forkel Kunigunda, widow, house 15 Leopold
 Forman Daniel R. machinist, b. 23 Comfort
 Forman Joseph P. engineer, steamer No. 4,
 house 23 Comfort
 Forman William H. boards 23 Comfort
 Forming William, clerk, b. 103½ East Main
 Forner Carl, deceased May 10, 1876
 Forner Charles J. insurance agent, 8 Powers'
 buildings, boards 98 Hudson
 Forrest Ambrose, tailor, h. Carter n. Norton
 Forrest Melvina, widow, house 18 Helena
 Forristal Catharine, widow, bds. 60 Joiner
 Forristal Robert J. painter, 10 Front, house
 60 Joiner [avenue
 Forschler Catharine, widow, h. 70 Caledonia
 Forschler Frederick, optician, bds. 70 Caledo-
 nia avenue [Caledonia av.
 Forschler George H. clerk, 42 Allen, bds. 70
 Forschler Henry, clerk, 22 State, b. 70 Caledo-
 nia avenue
 Forster Adam, machinist, b. 112 West Maple
 Forster Michael, harnessmaker, 65 State, h.
 36 Litchfield [n. Alexander
 Forster Samuel, coachman, bds. East avenue
 Forster Sebastian, carpenter, h. 112 W. Maple
 Forsyth Edmund A. (*Forsyth & Co.*), 5 An-
 drews, house at Brockport
 Forsyth Joseph, mason, house 44 Asylum
 Forsyth & Co. (*E. A. Forsyth, W. H. Jones,*
J. H. Truex and J. Nagle), scale manu-
 facturers, 5 Andrews [36 Wilder
 Fortmiller Lewis, blacksmith, 3 Canal, house
 Fortune Joseph H. boatman, b. 86 Exchange
 Fortune Sarah J. saloon, 86 Exchange, h. do.
 Forward James H. painter, bds. 99 Bartlett
 Forward John C. painter, 14 Stone, house 99
 Bartlett
 Fossick Frank, carriagemaker, b. 20 Prospect
 Fosome Charles A. clerk, 67 West av. b. do.
 Fosome James, saloon, 67 West av. h. do.
 Foss Simon, cabinetmaker, house 105 Saxton
 Foss Winfield S. shoemaker, 111 State, bds.
 York House [line
 Foster Adam, machinist, h. W. Maple n. city
 Foster Arthur R. foreman, Plymouth av. n.
 rapids, house do.

Foster Charles, gardener, house 70 Ontario
 Foster Charles S. brakeman, bds. 27 Kirk
 Foster Delos W. boards 27 Kirk
 Foster Edward E. conductor, b. 1 Harrison
 Foster Edward J. removed to Lyons
 Foster Eliza L. domestic, bds. 30 N. Union
 Foster Fred C. joiner, 2 Hill, b. 50 Hudson
 Foster Frank M. house 247 North
 Foster Frank P. brakeman, N. Y. C. R. R. house 64 Baden
 Foster George, collector, bds. 70 Ontario
 Foster George, gas fitter, 117 West Main, h. rear S. St. Paul opposite Griffith
 Foster George H. yard master, house 38 Greig
 Foster Huldah G. widow, house 91 Frank
 Foster James K. house rear South St. Paul opposite Griffith
 Foster John jr. salesman, 50 Mill, house at Grand Rapids, Mich.
 Foster John H. hostler, 78 Plymouth av. b. do.
 Foster Julia A. Mrs. house 27 Kirk
 Foster Lemuel E. clerk, 86 State, house do.
 Foster Lucinda Miss, house 12 North Frances
 Foster Lucy, widow, house 4 Oak
 Foster Maggie, domestic, bds. 128 Alexander
 Foster Mary, widow, b. r. S. St. Paul opp. Griffith
 Foster Mary E. widow, house 372 Brown
 Foster Norman, farmer, bds. Clinton Hotel
 Foster Seth O. music teacher, bds. 38 Greig
 Foster Tillie G. boards 26 Ward [Mass.
 Foster Wendell F. removed to Greenfield,
 Foster Wm. S. real estate broker, b. 91 Frank
 Foster, see Forster
 Fothergill Joseph, carriage maker, rear 145 East Main, house 60 Chatham
 Foulds Andrew, cooper, house 10 Bloss
 Foulds Maggie L. teacher, Whitney School No. 17, bds. 10 Bloss [bds. 10 Bloss
 Foulds William, bookkeeper, 53 East Main,
 Found Richard, miller, boards Mansion opp. Violetta
 Fouquet John, bootmaker, 92 State, bds. 313 North Clinton [Clinton, house do.
 Fouquet Philip, carpenter, 313 North
 Fowle Harvey B. target, h. 94 Pinnacle av.
 Fowle William K. saloon, 37 Front, h. do.
 Fowler A. R. agent, boards Chapman House
 Fowler Charles E. policeman, City Hall, h. 29 Cypress
 Fowler Daniel, stone mason, h. 116 Saxton
 Fowler Eliza A. widow, house 10 Jones
 Fowler George B. butcher, boards 10 Jones
 Fowler Geo. W. peddler, 144 East Main
 Fowler Harriet Miss, b. East Main c. Scio
 Fowler Horton L. clerk, 21 West Main, bds. 15 Asylum
 Fowler James, house 151 Alexander
 Fowler Jane M. house 210 East Main
 Fowler J. S. salesman, 36 Exchange, house at Hornellsville
 Fowler Sidney A. carpenter, b. 151 Alexander
 Fowler Sophronia, widow, house 31 Cypress
 Fowler William, boards 11 Hill
FOWLER WILLIAM P. oculist and
 aurist, 27 Fitzhugh, boards 31 do.—See page 513
 Fox Charles A. 81 N. Water, h. 64 North av.

Fox Dorcas M. sewer, 81 N. Water, bds. 64 North avenue [Frank
 Fox Edward, blacksmith, 8 Centre, house 71
 Fox Edward T. student, Roch. Theological Seminary, boards Trevor Hall
 Fox Edwin R. sidewalk maker, boards 54 University avenue
 Fox Emma J. widow, h. 54 University av.
 Fox George F. laborer, house 30 Gregory
 Fox George M. bartender, 160 State, boards 17 Tappan
 Fox Jacob, grocer, 187 N. Clinton, h. do.
 Fox Jacob, carpenter, 27 Kelly, house do.
 Fox Jacob F. tinsmith, 79 South St. Paul, boards 19 Kelly
 Fox John, laborer, boards 31 South St. Paul
FOX JOHN T. watches, jewelry, &c., 3 State, house 79 Fitzhugh.—See page 592
 Fox Joseph, blindmaker, 7 W. Main, house 18 Marion
 Fox Joseph H. B. removed to Michigan
 Fox Julia, house 13 Division
 Fox J. Marsden, photographer, h. 46 Ambrose
 Fox Katie, dressmaker, boards 71 Frank
 Fox Mary, widow, house 51 Manhattan
 Fox Mary E. seamstress, 23½ Romeyn, b. do.
 Fox Michael E. house 13 Manhattan
 Fox Nicholas, carpenter, Joiner near Kelly, boards East Main
 Fox Peter, removed from city [E. Main
 Fox Philip, woodworker, 3 Aqueduct, b. 121½
 Fox Royal A. house 52 Court
 Fox Sarah J. seamstress, boards 23½ Romeyn
 Fox Wm. carpenter, house 61 Thompson
 Fox William T. plumber, 25 Exchange, bds. 51 Manhattan [Frank
 Fox Wm. T. plumber, 66 East Main, b. 71
 Fox see Fuchs [26 Vose
 Fraas John A. shoemaker, 12 Market, house
 Fraine Thomas W. taxidermist, house 13 Joslyn park
 Fraley George W. removed to Penfield
 Fralich George, laborer, house 59 Campbell
 Fralick Charles A. carpenter, b. 332 State
 Frame Joseph, machinist, Brown c. Jones, house 33 Saxton
 Frame Rebecca, widow, h. 36 West Smith
 Frame Robert, laborer, h. Saxton cor. West Smith [avenue, house do.
 Francis Alexander S. grocer, 84 Monroe
 Francis Alphonso A. school policeman, h. Beach corner Parkland
 Francis Amy J. deceased, Oct. 1875
 Francis Anna, nurse, Roch. Orphan Asylum, boards do. [St. Paul
 Francis David H. caulker, house 282 North
 Francis George, house 62 Bartlett
 Francis Henry A. carriage maker, 3 Canal, boards 80 West avenue [Parkland
 Francis Hiram B. caulker, house Beach cor.
 Francis Jay, removed to California
 Francis Samuel, waiter, boards 62 Bartlett
 Francis Simon, bell boy, Osburn House
 Francisen Jacob, shoemaker, house 12 Vose
 Frank Adolph, optician, 179 N. St. Paul, b. 57 Smith
 Frank Barbara, widow, house 54 Herman
 Frank Barbara, widow, boards 6 Bartlett

Frank Caroline Mrs. house 5 Hudson
 Frank Charles, laborer, house 21 Wadsworth
 Frank Charles, teamster, at Gas Works, h. 74 Bartlett [boards do.]
 Frank Charles M. clerk, North c. Woodbury
 Frank Christian F. teacher, Fitzhugh near Allen, boards 19 Grove [bell]
 Frank Christopher, carpenter, b. 133 Camp-
 Frank Dominick, cigarmaker, Leavenworth al. n. Champion, h. Eighth n. Emerson
 Frank Edward, laborer, h. 6 Janes near Jay
 Frank Francis M. teamster, h. 136 Pinnacle avenue [bury, house do.]
 Frank George F. grocer, North cor. Wood-
 Frank Gregor, grocer, Monroe av. c. Good- man, house do.
 Frank Henry, shoemaker, house 6 Thomas
 Frank Henry, turner, 135 N. Water, boards 54 Herman
 Frank H. Louis, carpenter, house 44 Orange
 Frank Jacob, foreman, 14 Mumford, house 69 North avenue [Bartlett]
 Frank Jacob, policeman, City Hall, house 6
 Frank Jacob, machinist, Brown cor. Jones, house 57 Smith
 Frank John, laborer, house 70 Lincoln
 Frank John, laborer, house 133 Campbell
 Frank John M. cutter, Mill corner Mumford, house 64 Joiner
 Frank John R. cutter, 64 Mill, b. 64 Joiner
 Frank Joseph, machinist, house 103 Orange
 Frank Joseph, painter, 16 Stone, house 36 Temperance buildings [St. Paul]
 Frank Joseph, cooper, house 148 North
 Frank Mary, widow, h. North c. Woodbury
 Frank Peter, upholsterer, 184 State, house Ackerman near Bay [Champion, h. do.]
 Frank Peter, cigarmaker, Leavenworth al. n.
 Frank Peter, tailor, house 156 State
 Frank Philip, switchman, N. Y. C. R. R. house 19 Baden
 Frank Theodore, grocer, 94 Meigs, h. do.
 Frank Theodore, driver, Osburn House, b. do.
 Frank Valentine, carpenter, 23 Gorham, h. 32 Selliger [94 Meigs]
 Frank Wigbert, clerk, 101 North Clinton, b.
 Frank William, carpenter, h. 27 German
 Frank Bernard, tailor, 10 W. Main, bds. 12 N. Clinton
 Franke Ernest, removed to Irondequoit
 Frankenberg Jacob, peddler, h. 223 Pinnacle avenue
 Frankenberg Fred. W. removed to Buffalo
 Frankenger Enos, grocer, 18 Hebard, h. do.
 Frankenstein Carl, laborer, house 13 Rauber
 Franklin Charles, tobacco worker, 23 West Main, bds. 49 Kirk
 Franklin C. A. removed from city
 Franklin Elizabeth, widow, h. 17 Alexander
 Franklin Henry H. clerk, 207 S. St. Paul, b. 17 Alexander
 Franklin Joseph, machinist, house 49 Kirk
 Franklin Leo, removed to Europe
 Franklin Mary E. deceased March, 1876
 Franklin William A. removed to Syracuse
 Franklin William E. painter, 3 Canal, house 45 Reynolds
 Franks Louis E. Mrs. widow, b. 86 N. Clinton

Franz John, laborer, house 38 Baden
 Franz Louis, laborer, paper mills, h. 44 Orange
 Fransch Frederick J. cabinetmaker, 69 N. St. Paul, house 28 Rhine
 Fraser Agnes, domestic, boards 7 Scio
 Fraser Eliza, widow, house 34 Adams
 Fraser Hattie Mrs. dressmaking, 11 Gibbs, house do.
 Fraser James, shoe store, house 55 Davis
 Fraser James C. axlemaker, h. 19 Hunter
 Fraser Thomas, machinist, Mill cor. Factory, house 11 Gibbs [35 Prospect]
 Fraser William J. painter, 3 Canal, house
 Frauel Harriet, widow, house 30 Hanover
 Frauel Joseph, shoemaker, River n. North Water, house 5½ Granger
 Frauel Lawrence, tanner, 321 N. St. Paul, boards Clinton c. Norton [Norton]
 Frauel Theresa, widow, h. N. Clinton cor.
 Frauel Victor, morocco finisher, 321 N. St. Paul, bds. N. Clinton cor. Norton
 Frauenberger Eugene, printer, 59 Arcade, b. 38½ North avenue
FRAUENBERGER GEORGE, wood en- graver, 59 Arcade, house 38½ North av. —See page 517 [h. Date n. railroad]
 Frawley John, switchman, N. Y. C. R. R.
 Frazer John, bookkeeper, 50 Front, house North Clinton near Norton
 Frazer John jr. cabinet maker, Jay cor. Erie canal, house 53 Baden
 Frazer John, laborer, b. Lyell n. Myrtle
 Frazer Samuel, cooper, b. Lyell n. Myrtle
 Frazer Samuel, carpenter, house 6 Vernon
 Frazer William, deceased Nov. 1, 1875
 Frazer Wm. Mrs. widow, h. Lyell n. Myrtle
 Frazier Philip, wagonmaker, 161 Lake av. h. Perkins n. Lake av. [1 Webster]
 Freadendall Wm. fireman, N. Y. C. R. R. b.
 Freadman Bernard, carpenter, h. Michigan near Bauer [St. Paul]
 Frear John M. jeweler, 18 State, b. 11 North
 Freas John, moulder, 20 Court, b. 96 South St. Paul [av. h. do.]
 Freatman Alexander, carpenter, 3 Saratoga
 Fredenbug Charles L. bds. Waverley house
 Fredenbug Dena, widow, house Goodman corner Park avenue
 Fredenbug Martha J. widow, bds. 32 Jay
 Fredenbug William L. painter, house 3 Johnston block
 Fredenburgh, see Vredenburgh
 Frederick Peter, cooper, h. 59 Childs n. Jay
 Free John, laborer, house 113 Jones
 Freeburghouse Margaret, domestic, bds. 66 Lake avenue
 Freedman Andrew, house 5 Saratoga av.
 Freedman Andrew, carpenter, 3 Saratoga av. house Lyell n. city line [5. b. 283 State]
 Freeland Eliza, teacher, Central School, No.
 Freeman Arthur, painter, house 111 Frank
 Freeman Augustus H. hostler, bds. 5 Pine
 Freeman Benjamin F. special deputy county clerk, Court House, house 71 Allen
 Freeman Eliza, widow, boards 143 W. Main
 Freeman George H. bookkeeper, boards 40 Asylum
 Freeman James, whitewasher, house 5 Pine

A. R. PRITCHARD & LIKLY,

GLOVES, CANES, ETC., A LARGE STOCK, No. 78 STATE STREET.

Freeman Susan M. dressmaker, 40 Asylum, house do. [Water, bds. 21 Elm
 Freeman Wm. lastmaker Andrews cor. N.
 Freese Frederick, laborer, house 38 Oakman
 Freiday Karl, laborer, house 109 Meigs
 Freidel Joseph C. foreman, house 42 Joiner
 Freler Martin, blacksmith, 3 Canal, house 115
 Campbell [229 St. Joseph
 Frelier Abraham, shoemaker, 2 Hudson, h.
 Fremesser Andrew, laborer, house Field n.
 Monroe avenue [Monroe av.
 French Alfred A. packer, 62 State, house 210
 French Alvah R. bookkeeper, Washington
 Mills, boards 34 Stone [L. I.
 French Arthur S. removed to Sag Harbor,
 French Charlotte T. Mrs. house Frank c. Jay
 French Clarissa A. Miss, boards 38 Hickory
 French Edward, overseer, boards 38 Hickory
 French Elijah, maltster, house 47 Savannah
 French Eliza, widow, house 114 Adams
 French Eliza Miss, bds. 29 Plymouth av.
 French Emily S. widow, h. 191 N. Clinton
 French Frank, dentist, 58 State, h. 74 Troup
 French Jane M. widow, house 34 Stone
 French John, mason, house 129 Adams
 French John, removed to England
 French John M. stoves, &c. 76 East Main,
 boards 4 N. Washington
 French Joseph, shoemaker, h. 107 Monroe av.
 French Joseph L. clerk, 15 Exchange, boards
 39 N. St. Paul
 French J. Milton, deceased Oct. 1875
 French Louisa M. Mrs. widow, h. 79 Scio
 French Martha J. widow, house 34 Fitzhugh
 French Mary, widow, house 38 Hickory
 French Orra C. (*Hill & French*), 33 West av.
 boards 7 Trowbridge [Hamilton place
 French Rufus F. cutter, 25 Mill, house 5
 French Samuel, baker, 185 E. Main h. do.
 French Sanford W. clerk, 62 State, house
 26 Meigs [avenue
 French Wm. E. clerk, 62 State, b. 57 North
 Freudenvoll Henry, deceased Aug. 1, 1875
 Freudenvoll Josephine, widow, h. 22 Orange
 Freund Amelia, hairworker, boards 156 Jay
 Freund Barbara, seamstress, boards 156 Jay
 Freund Charles T. clerk, 1 East park, boards
 25½ Meigs
 Freund J. W. presiding elder, M. E. Church,
 house First avenue near Bay
 Freund Sebastian, cooper, house 156 Jay
 Freund William, boards First av. near Bay
 Frey Abraham, tailor, house 33 Gibbs
 Frey Adam, cooper, 30 Canal, h. 88 Campbell
 Frey Christian, cabinetmaker, 184 State, bds.
 103 Pinnacle avenue
 Frick John, teamster, h. Kelsey flats, near
 bridge, Vincent place
FRICK JOHN H. livery and boarding stable,
 47 S. St. Paul, house 24 Hamilton
 place.—*See page 608*
 Frick Louis, blacksmith, 29 Front, house 76
 Orange
 Fricker Anna, widow, house Finney n. Tyler
 Fricker Jacob, laborer, b. Finney near Tyler
 Fricker John, tinsmith, bds. Rohr near Bay
 Fricker John, shoemaker, N. Water cor. An-
 dreds, boards 22 Tyler

Fricquet Samuel, tailor, boards 8 Wilder
 Friday Ann, widow, boards 200 Jay
 Friday Frederick W. machinist, house 85
 Monroe avenue
 Friday Jacob, laborer, 8 Hill, house 200 Jay
 Friday Magdalena, widow, h. Jay n. Wacker-
 man
 Friday see Freiday
 Fridman Barnet, peddler, house 46 Catharine
 Friederich John H. liquors, 36 Front, h. do.
 Friedlay Mary, widow, boards 2 Catharine
 Friedman Bernard, carpenter, 3 Saratoga av.
 house Michigan n. Sherman
 Friedman Joseph, carpenter, bds. 100 Jay
 Friedman Morris, peddler, house 52 Atwater
FRIEDRICH ADAM, mason and contrac-
 tor, 27 Baden, house do.—*See page 633*
 Friedrich Elizabeth, widow, bds. 27 Baden
 Friedrich Francis, student, Rochester Theological
 Seminary, boards 118 Alexander
 Friedrich Philip J. printer, 18 N. St. Paul,
 boards 36 Front
 Friedrich Henry, house Hudson n. Bernard
 Friedrich John, laborer, bds. 58 S. St. Paul
 Friedrich Sabina, widow, house Hudson n.
 Bernard [house do.
 Friend Frances M. millinery, 152 N. Clinton,
 Friend Joseph P. frame joiner, 126 State, h.
 34 Wilder
 Friend Joseph W. sawyer, 123 Mill, house 152
 North Clinton [Wilder
 Friend Peter, cooper, 5 Charles, house 32
 Friery Joseph, porter, Whitcomb House, b. do.
 Frimiller Mary, widow, house 15 W. Troup
 Frink Deborah, widow, b. 36 N. Washington
 Frink William, teamster, 14 St. Joseph, h. 27
 Herman
 Frisch Enoch, house 79 North Clinton
 Frisch Frederick, butcher, 34 Front, bds. do.
 Frisch George A. foreman, N. Y. C. R. R.
 boiler shop, Platt, house 36 Grape
 Frisch Joseph, carpenter, Exchange c. Court,
 house 50 Monroe avenue
 Frisch Mary, widow, house 17 Baden
 Frisch Mary Anna, tailoress, bds. 5 Whalen
 Frisch Matthias F. tool maker, h. 89 Frances
 Frisch Peter, printer, 18 N. St. Paul, boards
 89 Frances
 Frisch Peter, box maker, boards 5 Whalen
 Frisch Thomas G. box maker, Aqueduct, h.
 1 Sauer park [church, b. 24 Franklin
 Frischbier Peter, assistant pastor St. Joseph's
 Frischholz Charles, grinder, 8 Hill, boards 5
 Almira [Maple
 Frischholz John B. laborer, house 126 West
 Frischholz Joseph, cooper, house 5 Almira
 Frischholz Thomas, cooper, house 5 Almira
 Frison Martin, house 20 North Water
 Fritag Christoph M. laborer, gas works, h.
 Diem near Caroline
 Fritchie Lewis, produce buyer, h. 47 Nassau
 Fritchie George F. teamster, h. 18 Grand
 Fritsch Conrad, tailor, boards 122½ Hudson
 Fritsch Ferdinand, laborer, house 96 Meigs
 Fritsch Henry, laborer, house 122 ½ Hudson
 Fritsch John, cabinet maker, h. 15 Wood-
 bury
 Fritsch Joseph, carver, bds. 122½ Hudson

Fritsch see Fritzsche
 Fritsche Herman, tassel maker, bds. 94 N. Clinton [house 6 Spencer
 Fritscher H. Adelbert, salesman, 143 State,
 Fritz Anton, cigar maker, 99 Wilder, h. do.
 Fritz Catharine, widow, h. 134 Pinnacle av.
 Fritz Catharine F. Mrs. midwife, house 14 Cayuga place
 Fritz Cornelius, tailor, 5 Joiner, house do.
 Fritz Elias, marble polisher, 122 S. St. Paul, h. Maria near Clifford
 Fritz George G. saloon, 293 N. Clinton, h. do.
 Fritz John, clerk, boards 177 North St. Paul
 Fritz John, polisher, foot of Falls, house 64 Gregory
 Fritz John G. mason, house 22 Hill
 Fritz John G. grocer, 177 N. St. Paul, h. do.
 Fritz John L. hostler, Clinton Hotel, house 7 Dover
 Fritz Martin, carver, boards 134 Pinnacle av.
 Fritz Peter, deceased, April, 1876
FRITZSCHE FRANK, hides and skins, 43 Front, house 15 Granger.—See page 665
 Fritzsche Frank J. bookkeeper, 43 Front, b. 15 Granger
 Fritzsche Hermann, fringe maker, 44 Exchange, boards 94 North Clinton
 Fritzsche John C. tanner, 43 Front, house 12 Bay
 Frobel John, laborer, house 14 Holland
 Froehlich John, removed to Pennsylvania
 Froehlich John, carpenter, house Alphonse near Thomas
 Froelicher Joseph, tailor, 14 Rauber, h. do.
 Froidevaux Celestin, plasterer, 9 Andrews, boards do.
 Fromherz Peter, tailor, 28½ E. Main, house 4 McDonald avenue [h. 285 Jay
 Fromm Caspar (*Bauerschmidt & Fromm*),
 Fromm George, farmer, b. Norton n. Carter
 Fromm John C. laborer, rear Exchange near Court, house 18 Bay [h. 51 Herman
 Fromm John F. chair maker, 119 N. Water,
 Fromm Leonard, tailor, 47 Hanover, boards Norton near Carter
 Fromm Valentine, farmer, h. Norton n. Carter
 Frossard Eugene, watch maker, Court cor. Stone, bds. 29 South [av. h. 166 do.
 Frost Charles J. flour and feed, 87 Plymouth
 Frost Edward A. boards 161 Plymouth av.
 Frost Eugene E. compositor, 82 West Main, boards 47 South avenue
 Frost George T. printer, house 47 South av.
 Frost Harriet J. widow, h. 155 Plymouth av.
 Frost Henry C. (*Frost & Co.*), boards 161 Plymouth avenue
 Frost Lydia P. Miss, bds. 126 Mt. Hope av.
 Frost Mary T. widow, b. 161 Plymouth av.
 Frost Minerva A. widow, house 20 Clarissa
 Frost Pamela S. widow, h. 161 Plymouth av.
 Frost Starr K. boots and shoes, 9 State, h. 124 Fitzhugh
FROST & CO. (*H. C. Frost and Edward Dague*), Genesee Valley Nurseries, 175 Plymouth av. cor. Frost av.—See front cover
 Frothingham Thomas, lawyer, h. 66 Lake av.
 Frowley James, laborer, house 25 Platt

Frutchey Peter G. slater, 90 E. Main
 Fry Charles, deceased October 30, 1875
 Fry Christian, laborer, house 40 Kirk
 Fry Christian, cabinetmaker, boards 103 Pinnacle avenue [house do.
 Fry Edward, blacksmith, Lyell near R. R.
 Fry George, painter, boards 40 Kirk
 Fry James W. piano manuf. h. 42 Park av.
 Fry Joseph, porter. Whitcomb House, b. do.
 Fry Nellie, widow, house Lewis n. N. Union
 Fry William, lastmaker, Shawmut buildings, boards 40 Kirk [22 N. St. Paul
 Frye Edward, salesman, 73 E. Main, boards
 Fryers Richard, grocer, 120 Oak, house do.
 Fuchs Charles F. saloon, 122 Front, h. do.
 Fuchs Dorothea, widow, house 34 Weld
 Fuchs Elizabeth, widow, house 19 Kelly
 Fuchs Jacob M. house 59 Herman
 Fuchs John, stonecutter, 22 West av. boards 34 Weld
 Fuchs John F. boards 19 Kelly
 Fuchs Joseph, mason, house 27 Henry
 Fuchs Julius C. gilder, boards 59 Herman
 Fuchs Mary, widow, house 187 N. Clinton
 Fuchs Mary, widow, house 16 Thomas
 Fuchs Nicholas, carpenter, b. 96 Chatham
 Fuchs Peter, laborer, State cor. Platt, house 424 Brown [64 Tappan
 Fuchs Valentine, stonecutter, 22 West av. h. Fuchs see Fox [Thomas
 Fuerderer Hannah, widow, b. Bernard near Fuerderer Peter, laborer, h. Bernard near Thomas
 Fuhrmann William, stonecutter, 22 West av. house 102 North av.
 Fullagar Mary, widow, house 329 State
 Fullam Nathan S. (*Fullam & Copeland*), h. 56 Scio
 Fullam Nelson Mrs. boards 40 Cherry
 Fullam Thomas, coal dealer, h. 42 Champlain
 Fullam & Copeland (*N. S. Fullam and G. E. Copeland*), real estate, 14 Smith's block
 Fullenweider Edward, butcher, 6 East av. house 2 Augusta
 Fuller Addie, housekeeper, Home for the Friendless, East av. cor. Alexander
 Fuller Albert G. printer, boards 18 Tappan
 Fuller Ann, house 120 North Water
 Fuller Christian, shoemaker, 111 Mt. Hope avenue, house do.
 Fuller Daniel P. (*Phillips & Fuller*), 157 East Main, house 80 University avenue
 Fuller Elizabeth, deceased March 30, 1876
 Fuller Henry P. clerk, house Market corner Mill [Livingston place
 Fuller James N. clerk, 147 State, boards 5
 Fuller Jerome, county judge, Court House, house at Brockport
 Fuller Joseph, shoemaker, 83 N. Water, h. 20 Campbell [Spencer
 Fuller Joseph B. foreman, 62 State, house 14
 Fuller Lida, milliner, boards 18 Joslyn park
 Fuller Marian Miss, music teacher, boards 55 Troup
 Fuller Sarah E. widow, boards 128 Jones
 Fuller William, mason, boards 12 Seward
 Fuller William M. house 18 Tappan
 Fullreader Henry, laborer, house 83 Cypress

A. R. PRITCHARD & LIKLY,

FINE MOROCCO SATCHELS,
 No. 78 STATE STREET.

Fulton Addie L. Mrs. teacher, House of Refuge, boards do.
 Fulton Francis B. bookkeeper, 102 West av. house Cady near Frances
 Fulton John, blacksmith, Lake avenue cor. White, house 17 Montrose
 Fulton Levi S. superintendent, Western House of Refuge, house do.
 Fulton Newell C. gilder, b. 86 University av.
 Fulton Robert, teacher, House of Refuge, boards do.
 Fulton Robert Otis, supt. Rochester Driving Park, house 15 Phelps avenue
 Fulton Sarah G. widow, boards 22 Stillson
 Fulton William B. teamster, house 21 Hamilton place
 Fundy Henry, bell boy, Osburn House
 Funkenstein Levi (*Funkenstein & Moore*), h. 44 Franklin
 Funkenstein & Moore (*L. Funkenstein & L. W. Moore*), clothing, 10 Mill
 Funnell Charles H. laborer, h. 16 Caledonia avenue
 Furbey Bazel S. barber, bds. 149 South av.
 Furbey William D. hostler, h. 149 South av.
 Furby Eugene, engineer, house 4 Madison
 Furby Henry O. thermometer maker, 3 Hill, boards 4 Madison
 Furby Jane, widow, boards 84 Frank
 Furlong James M. shoemaker, h. Magnolia n. Plymouth av.
 Furlong John, laborer, 102 Exchange, house 27 Frost avenue
 Furlong Michael, boards 27 Frost avenue
 Furlong Moses, carpenter, boards Frost av. near Frances [near Frances
 Furlong Philip, carpenter, h. Frost avenue
 Furlong William J. clerk, 75 S. St. Paul, b. 29 Frost avenue
 Furman Charles E. clergyman, b. 181 State
FURMAN, CHARLES E. jr. clothing, 2 West Main, h. 122 Alexander.—*See page 592*
 Furman, see Firman
 Fuss Eva, widow, boards 119 West Maple
 Fuss John, laborer, house 110 North avenue
 Futherer Benedict C. policeman, City Hall, boards 7 Elm
 Futherer Matthias, cigarmaker, 24 Gorham, house do. [N. Clinton
 Futterer Joseph, blacksmith, house 260
 Futterer Joseph jr. tailor, 19 Sellinger, bds. 260 North Clinton
 GABEL JACOB, tanner, 51 N. Water, house 135 St. Joseph
 Gabel John, laborer, house 98 Meigs
 Gabel see Goebel
 Gabelman Denkmer, locksmith, 3 Canal, h. 36 Wilder [boards 37 Glasgow
 Gable George, bookkeeper, 178 Plymouth av.
 Gabler Christian, bricklayer, h. 19 Hawkins
 Gabriel Sister, superior, St. Joseph's Orphan asylum, house 48 Andrews
 Gabriel Wilhelm, peddler, house 90 Kelly
 Gadrell George, shoemaker, house 8 Thomas
 Gadrell Theodore, shoemaker, 30 South St. Paul, house 2 North Stillson

Gadrell William, shoemaker, 22 Johnston's block, boards 2 North Stillson
 Gaeb John, boatbuilder, house 10 Oregon
 Gaebelmann David, locksmith, h. 36 Wilder
 Gaenzler Conrad, upholsterer, 74 State, bds. 88 South avenue [house do.
 Gaertner Matthias, hairdresser, 94 N. Clinton,
 Gaertner Wendelin, deceased Dec. 1875
 Gaesser Henry P. butcher, 213 North Clinton, house 2 Morris
GAFF, FLEISCHMANN & Co. compressed yeast manufs. 156 East Main, and 4 East avenue.—*See page 558*
 Gaffin Christopher, house 7 Davis
 Gaffin Mary, widow, house 47 Joiner
 Gaffin Mary Jane, gilder, 38 Gorham, boards 47 Joiner
 Gaffin Thomas, tailor, house 47 Joiner
 Gaffin Thomas H. deceased March, 1876
 Gaffney Bartholomew, laborer, b. Elmwood avenue
 Gaffney Bridget, widow, h. rear 302 State
 Gaffney Charles, traveling agent, 53 E. Main, house 66 Alexander
 Gaffney Charles D. traveling agent, 53 East Main, boards 11 Comfort
 Gaffney Hugh J. gardener, h. 79 N. Union
 Gaffney James, salesman, house 23 Charlotte
 Gaffney James, solicitor, 35 State, h. Vine
 Gaffney James, ice peddler, boards Rowe n. Erie canal
 Gaffney James, laborer, boards 44 N. Water
 Gaffney John, salesman, 53 E. Main, house 80 Broadway
 Gaffney Margaret Mrs. boards 80 Exchange
 Gaffney Matthew, switchman, h. 25 Walnut
 Gaffney Michael, ice peddler, boards Rowe near Erie canal
 Gaffney Owen, house 37 Spring
 Gaffney Peter, house 11 Comfort
 Gaffney Sarah, widow, boards 44 Oak
 Gaffney Thomas, laborer, h. Elmwood av.
 Gaffney William B. salesman, 53 East Main, boards 11 Comfort
 Gaffney's Block, East Main cor. N. St. Paul
 Gage Frank, surveyor, bds. 90 Monroe av.
 Gage Frederick W. machinist, Shawmut Mill, house 28 Scio
 Gage F. Dwight, painter, boards 7 King
 Gage George, laborer, house Plymouth av. near rapids
 Gage George A. hoop staple manufacturer, Mill corner Platt, house 40 Hickory
 Gage Ira, teamster, house 294 Plymouth av.
 Gage James L. patent rights, h. 41 Hickory
 Gage John F. machinist, boards 28 Scio
 Gage Joseph T. machinist, house Straub alley near Rowe
 Gage Mary, widow, b. 15 North Washington
 Gage Milo, clerk, boards 7 King
 Gage Omar F. clerk, Osburn House, house 75 East Main
 Gage Samuel A. removed to Darien, N. Y.
 Gage Wm. H. laborer, bds. 294 Plymouth av.
 Gagner Peter, shoemaker, 111 State, house 15 Oakman
 Gagnon Frank D. bar tender, Whitcomb House, bds. do.

- Galatian Samuel, removed to Chicago, Ill.
 Galbraith Anna M. teacher, Atwater School,
 No. 10, house 13 Cobb [Mt. Hope av.
 Galbrecht Henry, laborer, h. Wolcott near
 Galen Henry, carpenter, house 76 Kelly
 Galen John A. carpenter, boards 76 Kelly
 Galen John R. hairdresser, 1 Corinthian Hall,
 boards 76 Kelly
 Galitzderfer Geo. shoecutter, bds. 116 Orange
 Galitzderfer Urschele, widow, h. 116 Orange
 Gall Alexander, tailor, 79 State, house do.
 Gall John, tinsmith, 83 Exchange, boards 61
 Wilder
 Gall Lawrence, boatbuilder, h. 61 Wilder
 Gall Matthias, harnessmaker, 98 E. Main, b.
 61 Wilder [park
 Gallagher Bridget, housekeeper, h. Nichols'
 Gallagher Amelia R. Mrs. house 89½ Frank
 Gallagher Catharine, widow, bds. 9 Perkins
 Gallagher Eliza, widow, house Mansion near
 Magnolia
 Gallagher Henry J. (McDonnell & Co.), 24
 State, house 140 Alexander
 Gallagher James, laborer, bds. 68 Exchange
 Gallagher James, driver, 121 West Main, b.
 17 Atkinson
 Gallagher James, removed to Brockport
 Gallagher James jr. laborer, house 216 North
 St. Paul
 Gallagher Jane A. widow, bds. 55 Fulton av.
 Gallagher John, laborer, bds. Centre c. Mill
 Gallagher John E. tailor, h. 106½ W. Main
 Gallagher John H. carpenter, bds. 26 South
 Gallagher Joseph, laborer, bds. 218 W. Main
 Gallagher Kate E. stitcher, boards 9 Perkins
 Gallagher Maggie, stitcher, bds. 94 Frank
 Gallagher Mary, housekeeper, 75 N. Union
 Gallagher Mary A. domestic, 81 Lake av.
 Gallagher Patrick, laborer, house 3 York
 Gallagher Patrick, laborer, h. 55 Thompson
 Gallagher Richard, painter, 100 South St.
 Paul, house 30 Lancaster
 Gallagher Thomas, laborer, h. 28 Bartlett
 Gallagher William D. student, 41 State, bds.
 28 Spring [Joseph
 Galland Ignatius, cigarmaker, house 163 St.
 Galland Ignatz, framemaker, 126 State, h.
 164 St. Joseph
 Gallery Eliza, widow, house 25 Kent
 Gallery Frank B. physician, 256 State, house
 56 Frank
 Galley Henry, removed to Chicago, Ill.
 Galli Christian, saloon, 111 North av. h. do.
 Galliger George W. deceased Sep. 1875
GALLIGER MARY, turning and mould-
 ings, 3 Aqueduct, house 14 North Clin-
 ton.—See page 576
 Gallis John, teamster, bds. S. St. Paul cor.
 Court [bds. 116 Orange
 Gallitstrefer George, cutter, 91 North Water,
 Gallitzderfer Conrad, shoemaker, h. 27 Childs
 Gallivan Bartholomew, laborer, boards 5 Al-
 exander
 Gallivan Bridget, widow, h. 5 Alexander
 Galloway Alfred, carpenter, house Mansion
 corner Violetta
 Galloway Frederica E. teacher, Tremont
 School, No. 3, boards 50 Reynolds
- Galloway Zachariah, carpenter, house 50
 Reynolds [19 Swan
 Gallup John, sleeping car conductor, house
 Galluper Rudolph, tanner, house Flint near
 Frances [h. 71 Pinnacle av.
 Gallus Jacob N. carpenter, Minerva alley,
 Gallusser John, yardman, 149 Exchange, b.
 50 South St. Paul
 Gally Merritt, clergyman, h. 9 Arnold park
 Galusha Almira, widow, boards East avenue
 cor. Goodman [bds. 26 Elizabeth
 Galusha Charles C. bookkeeper, 20 Court,
 Galusha Elon A. Mrs. widow, h. 18 Gorham
 Galusha Elon C. bookkeeper, h. 26 Elizabeth
GALUSHA NORMAN H. iron founder,
 20 Court, house 43 South Clinton corner
 Court.—See page 693
 Galvin Catharine, widow, house King corner
 Brown
 Galvin Elizabeth, widow, boards 6 Campbell
 Galvin John, laborer, house Ontario corner
 North Union [cor. North Union
 Galvin Patrick, blacksmith, boards Ontario
 Gamball Jane, widow, house 5 Costar
 Gamble Amelia, boards East av. c. Alexander
 Gamble Richard, florist, house East avenue
 near Goodman [bds. 25 Ward
 Gamel Frank H. carpenter, 87 Exchange,
 Gamel Nicholas, shoemaker, 249 N. Clinton,
 house do.
 Gamel Peter, shoemaker, house 25 Ward
 Gammache Louis, peddler, house 11 Smith
 Gamroth Henry, bricklayer, boards 38½
 Gregory
 Gamwell Chas. H. tailor, 43 E. Main, b. do.
 Gamwell Rosalia Mrs. house 5 Newton blk.
 Gando Charles, carpenter, b. 13 Vincent place
 Gando Nelson, carpenter, h. 13 Vincent place
 Gandren George, shoemaker, 235 East Main,
 house 2 Huron [34 South Washington
 Ganey Thomas, carriage maker, 9 Ely, bds.
 Gangloff Frank, cooper, 30 Canal, boards
 267 Brown [mouth avenue
 Gangloff John, glassblower, boards 168½ Ply-
 gangloff Xavier, cooper, 30 Canal, house 267
 Brown [ilton place
 Gangros Elizabeth, tailoress, boards 30 Ham-
 gangros Frank, laborer, house 67 Caroline
 Gangros Henry, teamster, 20 Court, house 30
 Hamilton place
 Gannon Frank, clerk, boards 67 Scrantom
 Gannon Gilbert, clerk, boards 67 Scrantom
 Gannon Margaret, widow, house 8 Jackson
 Gannon Mary, widow, house 144 N. St. Paul
 Gannon Mary, widow, house 67 Scrantom
 Gannon Michael tailor, h. Scio corner Davis
 Gannon Michael jr. grocer, Scio cor. Davis,
 boards do. [boards do.
 Gannon Michael K. grocer, 144 N. St. Paul,
 Gannon Martin, machinist, boards Scio. cor.
 Davis
 Ganol Peter, laborer, house 41 King
 Gant James, shoe manuf. River near N. St.
 Paul, house 5 West Troup
 Ganyard Enos Mrs. removed to Boston, Mass.
 Ganyard Henry O. real estate, 41 Arcade, h.
 26 Lincoln
 Garber Joseph, removed from city

GARBUTT JOHN W. cement manuf. rear Court near Exchange, house at Scottsville.—*See page 581* [at Gatesville.]
 Gardiner Addison, 57 Powers' bldgs. house
 Gardiner Chas. carpenter, h. 222 Alexander
 Gardiner John H. carpenter, house 31 Tyler
 Gardiner Robert, foreman, 83 N. Water, house 131 Jones [opposite Vick park
 Gardler Rachel, domestic, boards East av.
 Gardner Abner, insurance, 32 Arcade, boards 119½ East Main [h. 60 Oakland pk.
 Gardner Addison K. machinist, r. 204 State,
 Gardner Agnes, A. Mrs. boarding house, 107½ East Main
 Gardner Alexander, painter, house Vick pk.
 Gardner Anna A. widow, boards 79 Scio
 Gardner Anna M. millinery, 130 State, h. do.
 Gardner Byron, foreman, 4 Caledonia av. house 12 Favor
 Gardner Caroline, widow, boards 18 Prince
 Gardner Corlis B. pastor, Westminster church, house 2 New York
 Gardner Frances, teacher wax flowers, house 42 Hamilton place
 Gardner George, house 42 Hamilton place
 Gardner George, removed to Elmira
 Gardner George S. overseer, Rochester Cotton Mill, foot Centre, boards 55 Magne
 Gardner G. Edwin, painter, boards 116 State
 Gardner Hannah B. widow, boards 37 Savannah [h. 21 Vienna
 Gardner Jacob G. barber, 83 West avenue,
 Gardner John, grinder, 100 S. St. Paul, house 3 Gibbs [Jones
 Gardner Latham, painter, 14 Stone, house 68
 Gardner Lauren P. agent, 10 Exchange, house 14 Ambrose
 Gardner Locky Ann, widow, house 31 Hunter
 Gardner Mary J. Miss, boards 31 Hunter
 Gardner Millard, shoe fitter, 111½ N. Water, boards 107½ East Main
 Gardner Mitchell C. machinist, h. 10 Spencer
 Gardner Nancy A. widow, house 114 State
 Gardner Newman H. patent medicines, 149 State, house do.
 Gardner Susan Mrs. house 97 Hunter
 Gardner Thomas, grocer, 9 Magne, house do.
 Gardner Wm. coachman, 21 East av. house 13 Sycamore [R. R.
 Gardner Wm. machinist, b. Goodman corner
 Gardner Wm. W. turner, 3 Aqueduct, house 29 Hunter
 Gardner, see Gardiner
 Gargan Thomas H. roofer, h. 133 Tremont
 Garger John, carpenter, house 169 Jay
 Garin James, tobacco dresser, 55 S. St. Paul, boards 8 Catharine
 Garin Mary, widow, house 8 Catharine
 Garin Patrick (*Garin & Meagher*), house 128 East Main
GARIN & MEAGHER (*Patrick Garin and Patrick Meagher*), cigar manufs. 147 East Main.—*See page 564*
 Garland Geo. S. actor, house 55 Nassau
 Garland James F. conductor, N. Y. C. R. R. house 33 Chatham
 Garland Louis, optician, house 49 Chatham
 Garland Peter, cigarmaker, house 52 Cady

Garlic Charles, traveling agent, 100 S. St. Paul, house at Syracuse [Chestnut
 Garlock James S. lawyer, 38 Arcade, h. 54
 Garmonsway James, butcher, h. 101 Kelly
 Garnryck Margaret, widow, house 25 Madison
 Garretsee John R. 44 Exchange, house at Spencerport [152 N. St. Paul
 Garrett John J. policeman, City Hall, house
 Garrick Philip, laborer, 122 S. St. Paul, h. 20 McDonald avenue
 Garrigus Cyrus, mason, boards 1 Reynolds
 Garring Fred. house Hollenbeck near North Clinton [near Clifford
 Garring Wm. upholster, house N. Clinton
 Garrison Charles B. removed to Troy
 Garrison Daniel P. h. 1 Grove [Norton
 Garrison Ezra J. teamster, bds. Hudson near
 Garrison Helen, deceased May, 1875 [18 do.
 Garrison Jacob H. laborer, 4 Griffith, house
 Garrison Jacob S. agent, 45 E. Main, bds. 1 Grove
 Garrison John, boat builder, h. 13 Bolivar
 Garrison Martin, clerk, 33 North av. bds. do.
 Garrison Minard, mason, h. 79 Pinnacle av.
 Garrison Wm. teamster, h. Hudson n. Norton
 Garrison Wm. H. machinist, bds. 12 Green
 Garrity Ann Miss, house Pearl near Union
 Garrity Bridget, widow, bds. Pearl n. Union
 Garrity John, laborer, boards 39 Bolivar
 Garrity Kiern, flour packer, Washington Mills, house 21 Vincent place
 Garrity Mary, widow, house 5 Factory
 Garrity Thomas, flour packer, Jefferson Mills, boards 5 Factory
 Garsden Alice, widow, bds. 63 Thompson
 Garsney Hiram, laborer, house 184 Scio
 Garson David M. editor, 16 West Main, bds. 122 East Main
GARSON HENRY & SON (*Moses H. Garson*), clothiers, 75 East Main, house 47 Clinton place.—*See page 543*
 Garson Hiram H. bookkeeper, 75 E. Main, boards 47 Clinton place [Clinton pl.
 Garson Isaac H. clerk, 75 East Main, bds. 47
 Garson Jacob, h. 9 University av. [Clinton
 Garson Jacob L. salesman, 44 Mill, b. 63 N.
 Garson Joseph, cashier, 16 W. Main, boards 122 East Main
 Garson Leopold & Co. (*E. Kerngood*), clothiers, 44 Mill, house 63 North Clinton
 Garson Moses & Co. (*T. Meyer*), clothiers, 16 West Main, house 122 East Main
 Garson Moses H. (*H. Garson & Son*), 75 East Main, house 46 University avenue
 Garson Moses L. salesman, 44 Mill, bds. 63 North Clinton
 Garstner August N. house 31 Scrantom
 Garstner Louis, carpenter, house 44 Scrantom
 Garstner Theresa, tailorress, bds. 21 Scrantom
 Garthefer Conrad, stone cutter, 54 Fitzhugh, house 71 Sanford
 Garthefer Conrad Mrs. house 33 Sanford
 Garthoffner Elizabeth, widow, boards Hudson near Clifford [chester, b. 5 Scio
 Garton Joseph V. student, University of Ro-
 Gartshore James, teamster, house 34 Bloss
 Garvey Andrew, switchman, house North Union corner railroad

- Garvey Bridget, waiter, Whitcomb House
 Garvey Edward, laborer, h. Pennsylvania av. cor. Fourth av.
 Garvey James, laborer, house Augusta near North Union [n. Flint
 Garvey John, laborer, gas works. h. Frances
 Garvey Patrick, switchman, h. 75 Davis
 Garvey Patrick, blacksmith, 55 Fitzhugh, house 3 Cobb [Allen
 Gascoigne Alfred, tree agent, h. Brown cor.
 Gascoigne Clarence E. bookkeeper, River corner N. Water, boards 146 Scio
 Gascoigne James, manager, River corner N. Water, house 146 Scio
 Gasgoin Jane, bds. East av. cor. Alexander
 Gaskell Clara E. Miss, clerk, 95 East Main, boards 55 South Union
 Gaskill Clarence E. dentist, 7 Crystal Palace block, boards Franklin square
 Gaskin John, shoemaker, 22 Johnston block, boards 37 Tyler
 Gaskin Josephine, widow, house 37 Tyler
 Gass Daniel, laborer, house 18 Helena
 Gassner Joseph, laborer, house Vernon park near North Clinton
 Gast Henry, removed to Greece
 Gast Martin, carpenter, house 6 Vose [gow
 Gatchell C. A. 178 Plymouth av. b. 37 Glas-
 Gatchell Nathan B. (*Gatchell & Co.*), 178 Plymouth av. house at Lancaster
GATCHELL & CO. (*N. B. Gatchell*), glass manufs. 178 Plymouth av.—*See p. 668*
 Gates Daniel, contractor, house 172 Frank
 Gatens Daniel jr. painter, boards 172 Frank
 Gatens George M. carpenter, bds. 172 Frank
 Gates Alonzo E. lastmaker, Shawmut bldg. boards 6 St. Clair [Washington
 Gates Catharine, washerwoman, house 41 S.
 Gates Elias, lastmaker, h. 1 Park av. [b. do.
 Gates Emma L. Mrs. student, 135 E. Main,
 Gates Eunice, widow, house 6 St. Clair
 Gates Frederick T. student, University of Rochester, boards 17 Marshall
 Gates George W. conductor, N. Y. C. R. R. house 133 St. Joseph [cor. Smith
 Gates Henry P. grocer, 347 State, h. Frank
 Gates Jane, widow, house 133 St. Joseph
 Gates Margaret, seamstress, h. 69 West av.
 Gates Sarah L. widow, house 3 Brighton av.
 Gates Mrs. cook, Farmers' Hotel, bds. do.
 Gates, see Goetz
 Gattner Christian, laborer, house 23 Vienna
 Gattner George, carpenter, h. Miller n. Bay
 Gattner Jacob, barber, house 21 Vienna
 Gauch John, tailor, h. 62 Orange [Sellinger
 Gauger John C. teacher, 20 Allen, house 6
 Gauger Martin, tobacco worker, b. 23 Lowell
 Gauh John (*Gauhn & Klein*), bds. 26 South
 Gauhn & Klein (*J. Gauhn and F. Klein*), plumbers, 66 East Main
 Gaul Charles, porter, house 78 Adams
 Gault Elias H. teamster, house Lake av. n. Little Ridge road [Little Ridge road
 Gault Wm. E. teamster, boards Lake av. n.
 Gaus Louis, carpenter, house Thomas near Alphonse [house do.
 Gavagan Michael, grocer, Lime c. Orchard,
 Gavill John, painter, house 15 Syke
 Gavin Anna, dressmaker, 91½ Frank, b. do.
 Gavin John, removed to Louisville, Ky.
 Gavin Margaret, widow, bds. 21 Vincent pl.
 Gavin Michael, laborer, house 59 Saxton
 Gawne Mary, widow, house 61 William
 Gawne William, agent, boards 2 Sycamore
 Gay Azel, foreman, N. Y. C. wood shop, Brown, house 28 Orange
 Gay Charles, laborer, house 32 Ontario
 Gay Charles jr. cabinetmaker, 123 Mill, bds. 32 Ontario
 Gay Edgar A. machinist, Brown cor. Jones, bds. 28 Orange
 Gay Frank, polisher, 38 Gorham, boards 1 Sheridan park
 Gay Frank W. removed to Illinois
 Gay John, blacksmith, house 229 North
 Gay L. Fidelia, widow, bds. 43 S. Clinton
 Gay Richard R. clerk, 17 Weld, bds. do.
 Gay Robert, grocer, 17 Weld, b. 128 Adams
 Gay William E. removed to Chili
 Gaylord Leonard J. boards 50 Jones
 Gaylord Martha E. teacher, Free Academy, boards 69 Court
 Gaylord Mary A. widow, house 50 Jones
 Gaylord Mary E. Miss, music teacher, boards 50 Jones
 Gaylord Mary E. Miss, boards 69 Court
 Gaylord Willis C. clergyman, bds. 50 Jones
 Geare Chas. W. perfumer, h. Rowe c. Thrush
 Gearing William, upholsterer, house North Clinton near city line
 Geary Richard, teamster, h. 22 Vincent pl.
 Gebbing Henry, laborer, h. Perkins corner Aldern
 Gebele Jacob, mason, house 51 Whitney
 Gebhard Frank, house 1 Clifford
 Gebhard Mary, tailoress, boards 1 Clifford
 Gebhard Michael, tailor, house 16 Sellinger
 Gebhardt Charles C. peddler, house Lincoln near Clifford
 Gebhardt John M. removed to Parma
 Gebhardt Regina Dorothea, widow, house Phelps avenue corner Lake avenue
 Gebhardt Regina D. Miss, milliner, boards Phelps avenue corner Lake avenue
 Geddes Celia Mrs. boards 6 South Clinton
 Geddes Robert S. supt. Magne opp. Walnut, boards 56 Magne
GEDDES WILLIAM B. furnace manuf. 29 Exchange, and cooper, Magne opposite Walnut, house 56 Magne.—*See page 616*
 Geddiss Robert, laborer, house 163 Scio
 Gee George P. agent, house 140 Cady
 Gee Samuel, Chinese laundry, 100 E. Main, boards do.
 Gefell Edward, watchmaker, 114 North av. b. North Clinton cor. avenue A
 Gefell John B. carriage painter, 3 Canal, h. 15 Syke
GEHRES PETER, saloon, 76 N. St. Paul house do.—*See page 596*
 Gehrig Laurence, cooper, Magne opp. Walnut, house 233 Jay
 Gehrig Philip, laborer, h. 20 McDonald av.
 Gehrke Albert E. blacksmith, h. 5 Edward
 Gehweiler Joseph, cabinetmaker, 2 Hill, h. 41 Ontario

Geib Jacob, laborer, house 59 Cady
 Geib John, laborer, house Bartlett c. Frances
 Geider Regina, widow, boards 20 Holland
 Geier Valentine, machinist, Court c. Stone,
 house 25 Gorham [Penn.]
 Geiger Edward J. removed to Philadelphia,
 Geiger Elias H. (*F. C. Cook & Co.*), lumber,
 311 State, house at Dansville
 Geiger Ernestine, tailoress, bds. 46 Galusha
 Geiger Eva, widow, house 46 Galusha
 Geiger Frances, carpet weaver, bds. 19 West
 Geiger John, cooper, West near Lyell, house
 19 West
 Geiger John, shoemaker, house 148 Jay
 Geiger John A. butcher, 51 North av. boards
 22 University avenue
 Geiger Wm. laborer, house Goodman n. Bay
 Geimer Andrew, laborer, house 12 Clifford
 Geimer Elizabeth, tailoress, bds. 12 Clifford
 Geimer George, deceased, April 1875
 Geimer Jacob, flour and feed, 244 North
 Clinton, house do.
 Geimer John, clerk, 6 S. St. Paul, h. 23 Cole
 Geimer Michael, teamster, C. B. Hill's, h.
 24 Cole [Main]
 Geir Charles H. mason, house 106½ West
 Geir George, chair bottomer, h. Pine alley
 Geir Jacob L. confectioner, 37 Monroe
 avenue, house do.
 Geis Abraham, cigar manuf. 39 Lowell,
 house do.
 Geis Bernhart, mason, house 31 Vose
 Geis Frederick, laborer, h. 258 N. Clinton
 Geis Joseph, machinist, h. Vose c. Edward
 Geishoof August, brick layer, h. 17 Hawkins
 Geisler Frederick, shoecutter, 55 Mill, house
 16 Norton
 Geisler John, watchman, h. 2 Leavenworth
 alley
 Geisman Solomon, butcher, h. 128 Champlain
 Geisner Jacob, drover, bds. 55 St. Joseph
 Geisner Louis, clerk, 90 Plymouth av. bds.
 16 Tremont
 Geiwitz George, tanner, house 22 Hoeltzer
 Geiwitz John, removed to Germany
 Gelbrecht Henry, teamster, house Wolcott
 near Mt. Hope
 Gelling Electa, boards 84 Alexander
 Gelling Margaret, widow, h. 84 Alexander
 Geminder John, mason, house 21 Kirk
 Gemming Edward G. laborer, h. St. Joseph
 near Hayward park [Frank]
 Geneive Sister, Convent Nazareth, Jay cor.
 Genkel Christian, teamster, house Culver n.
 Norton
 Genkel Dores, domestic, boards 27 Vienna
 Gennett James, hairdresser, 339½ State, b. do.
 Genrick John, grocer, 76 St. Joseph, boards
 102 Chatham
 Gensimer Rosa E. waiter, 7 S. St. Paul
 Genter Delia, dressmaker, boards 8 Rome
 Genter Gustave, blacksmith, 3 Canal, house
 97 Reynolds
 Genter see Guenther
 Gentry John S. shoemaker, 83 North Water,
 boards 37 North St. Paul
 Genzler Charles E. cutter, bds. 88 South av.
 Genzler John, dry goods, 88 South av. h. do.

George Adam, mason, house Henrietta av. n.
 Pinnacle avenue [57 Saxton]
 George Andrew, clerk, 126 E. Main, boards
 George Benjamin, painter, b. 96 S. St. Paul
 George Charles W. clerk, 15 Exchange, bds.
 30 Park avenue
 George Frank, cooper, boards 57 Saxton
 George Frederick, grocer, Smith c. Saxton,
 house do. [Paul]
 George Frederick W. actor, h. 126 South St.
 George Josephine, clerk, Smith c. Saxton,
 boards 57 Saxton
 George Mary A. widow, house 57 Saxton
 Georger Martin, laborer, house 94 Orange
 Geraghty Patrick J. bookkeeper, 42 State,
 boards 35 St. Joseph
 Geraghty Thomas, house 35 St. Joseph
 Geraghty Thomas jr. blacksmith, 129 North
 Water, b. 35 St. Joseph [St. Joseph]
 Geraghty William, clerk, 40 State, boards 35
 Gerber Albert, shoemaker, 81 N. Water, h.
 64 Orange
 Gerber Louis, cutter, 74 Mill, h. 78 North av.
 Gerber Louis jr. tailor, 55 East Main, bds. 78
 North avenue [15 Syracuse]
 Gerew Edward, shoemaker, 92 State, house
 Gerew Joseph, tinsmith, 108 West Main, h.
 19 Kirk [98 East av.]
 Gerew Lewis, shoemaker, 92 State, house rear
 Gerger George, blacksmith, 3 Canal, boards
 Campbell corner Orchard
 Gerhard Daniel, boxcutter, 111 W. Main, h.
 23 Hunter
 Gerhardt Frank, hairdresser, W. Maple cor.
 Saxton, b. 54 W. Maple
 Gerig John, cabinetmaker, b. 94 N. Clinton
 Gerkin Fred, baker, 38 Fitzhugh, b. 158 do.
 Gerlach George, tailor, h. 86 Mt. Hope av.
 Gerlach George A. C. optician, boards 86
 Mt. Hope avenue [3 North Water]
 Gerling Brother (*J. and V. Gerling*), millers,
 Gerling Geo. clerk, 3 N. Water, h. 25 Wilder
 Gerling Jacob (*Gerling Bros.*), h. 300 Brown
 Gerling Valentine, 2d, flour packer, 3 North
 Water, boards 300 Brown
 Gerling Valentine (*Gerling Bros.*), house W.
 Maple n. Ames [cor. Allen]
 German Minerva Miss, laundress, b. Brown
 German Patience, domestic, Osburn House
 German Students Home, 118 Alexander
 Germyn Thomas, removed to Milwaukee,
 Wisconsin
 Germyn William, cartman, boards 11 Davis
 Gernandt Frederick, upholsterer, 73 State,
 house 78 Joiner [78 Joiner]
 Gernandt George, upholsterer, 73 State, bds.
 Gerndt Andrew, removed to New York city
 Gerner Barbara, widow, house 47 Kelly
 Gerner Helena Miss, tailoress, bds. 47 Kelly
 Gerner John, laborer, h. Dake near Hebard
 Gerns Julia, dressmaker, boards 315 State
 Gerry George, painter, house 155 West Main
 Gerry Rufus, painter, house 155 West Main
 Gerry Rufus P. house 155 West Main
 Gersley Jacob, blacksmith, 145 E. Main, b.
 127 Scio
 Gerstner Amon, laborer, house 1 German al.
 Gerstner Catharine Mrs. tailoress, h. Cobb

Gerstner Charles, clerk, 130 Front, house 18 Emmett [key avenue
 Gerstner Conrad, laborer, h. Clifford n. Conger
 Gerstner Joseph, deceased
 Gerstner Joseph, shoemaker, h. 10 Widman
 Gerstner Lewis, carpenter, 23 Gorham, h. Scrantom near Hawkins
 Gerstner Margaret, widow, b. 124 Hudson
 Gerstner Wendelin, laborer, 21 Plymouth av. house 50 Hoeltzer
 Gerstner William, grocer, 209 Scio, house do.
 Gerz Alois, tailor, boards 117 Jay
 Gerztner Wiendeler, machinist, boards 42 Madison C. Maple
 Gesell Andrew & Son (*J. S. Gesell*), ropemakers, Flint c. Genesee, house do.
 Gesell George (*Hoberker & Gesell*), 104 West avenue, house 18 King
 Gesell George J. lockmaker, 188 State, house N. Clinton near Bloomingdale avenue
 Gesell John S. (*Andrew Gesell & Son*), Flint cor. Genesee, boards do.
 Gessner Jacob, carpenter, house 8 Rauber
 Gethymer Conrad, laborer, h. Magne n. R. R.
 Getsinger George, removed to N. Y. city
 Getzkov Frederick, mason, house 189 Pinacle avenue
 Getzkov Gustave, mason, house 19 Wilson
 Getzkov William, mason, h. 111 Mt. Hope av.
 Geyer Albin, show cases, Aqueduct, h. Bates near Bowen
 Geyer Charles, carpet weaver, 7 Weld, h. do.
 Geyer Mary A. widow, b. Bates near Bowen
 Geyersbach Jacob, laborer, house 90 Kelly
 Ghaul Harry Mrs. house 16 South Ford
 Gibb Benjamin G. printer, house 28 Warner
 Gibbard Isaac (*Manning & Gibbard*), 122 Powers' bldgs. h. Chili road n. city line
 Gibbert Chauncey, agent, boards 26 Allen
 Gibbons Arthur J. (*Gibbons & Stone*), h. 4 Frank
 Gibbons Dewitt C. (*Gibbons & Stone*), house 7 Emmett
 Gibbons Dwight Mrs. widow, house 68 Allen
 Gibbons Frederick S. clerk, 117 W. Main, b. 68 Allen
 Gibbons John, nurseryman, boards 68 Cypress
 Gibbons Montgomery, bookkeeper, 16 Exchange, boards 4 Chestnut
 Gibbons Washington, lawyer, h. 4 Chestnut
GIBBONS & STONE (*A. J. and D. C. Gibbons and L. L. Stone*), piano forte manufs. 4 and 6 Hill, warerooms 86 State.—See page 525
 Gibbs Albert, hostler, rear 1 Franklin
 Gibbs Asgill, lawyer, boards 8 Gardiner pk.
 Gibbs Frederick, cooper, h. r. 57 Monroe av.
 Gibbs George, cutter, 14 Mumford, house German cor. Philander
 Gibbs George D. removed to Medina
 Gibbs James, deceased July 19th, 1875
 Gibbs Jonathan, hostler, 11 Andrews, house 69 North avenue
 Gibbs Lavina, widow, h. rear 57 Monroe av.
 Gibbs Lewis H. printer, 1 Aqueduct, boards 37 Atkinson
 Gibbs Lovel, carpenter, boards 3 Phelps av.
 Gibbs Mary A. widow, house 37 Atkinson

Gibbs Nellie Miss, house 15 Frank
 Gibbs Orren S. hairdresser, 154 North av. house 32 North avenue [212 Alexander
 Gibbs Robert, tailor, 74 Smith's block, house
 Gibbs Walter, shoemaker, 79 North Water, house 50 Hunter [290 East Main
 Gibbs Warren S. engineer, N. Y. C. R. h.
 Gibbs William, house 117 South avenue
 Gibbs William H. shoemaker, 15 Mill, house 120 State [house do.
 Gibbs W. H. Mrs. magnetiser, 120 State,
 Gibney John, canmaker, 134 North Water, b. Clinton Hotel [Refuge, boards do.
 Gibson Annie P. Mrs. seamstress, House of
 Gibson Catharine, sewer, boards 36 Spencer
 Gibson Isabella B. widow, boards 212 Brown
 Gibson Law S. chief engineer, fire department, 61 Front, house 10 Trowbridge
 Gibson Mason H. engineer, house 20 Weld
 Giddings Abbie A. seamstress, b. 129 Monroe avenue [roe avenue
 Giddings Amanda, seamstress, h. 129 Mongiel Caspar, heelcutter, 124 Front, boards 31 Hoeltzer
 Giebel Christopher, laborer, boards 27 Bond
 Giebel Leopold, peddler, house 27 Bond
 Giebel Valentine, cabinetmaker, house 31 Hoeltzer
 Gier Gottfried, laborer, house 47 Orchard
 Giering Joseph X. removed to Penfield
 Gifertt John M. cabinetmaker, 7 N. Water, boards Lake avenue [c. N. Clinton
 Gifford Andrew, screwmaker, bds. Atwater
 Gifford Charles H. (*A. V. Smith & Co.*), 65 State, house 7 Livingston place
 Gifford Clifton C. engraver, 16 Elwood blk. house 8½ Chestnut [house do.
 Gifford Fanny Mrs. music teacher, 34 Ward,
 Gifford Filmore, carpenter, 93 Exchange, b. 42 Weld [avenue
 Gifford Foster C. clerk, 36 State, bds. 18 East
 Gifford Gee D. car inspector, N. Y. C. car shop, house 42 Weld
 Gifford Henry D. machinist, bds. 203 State
 Gifford James, house 34 Ward
 Gifford James A. cutter, boards 34 Ward
 Gifford Jane M. widow, bds. 8 Madison pk.
 Gifford Jesse W. house 125 Lake avenue
 Gifford Orrin P. student, Rochester Theological Seminary, boards Trevor Hall
 Gifford Sarah J. widow, house 37 Franklin
 Gifford Wm. E. engraver, 16 Elwood block, boards 37 Franklin [Atwater
 Gifford Wm. L. engineer, h. N. Clinton n.
 Gilbert Albert T. machinist, bds. 23 Brown
 Gilbert A. Mrs. nurse, house 68 Sibley's blk.
 Gilbert Benjamin, deceased April, 1876
 Gilbert Charles F. cutter, boards 5 Pitt
 Gilbert Charles G. brassfinisher, Court cor. Stone, house 14 Cypress
 Gilbert Charles H. brakeman, h. 23 Strong
 Gilbert Francis W. foreman, 20 Court, h. 18 North avenue
 Gilbert Francis W. jr. tinsmith, 144 E. Main, boards 18 North avenue [21 Olean
 Gilbert Frederick W. clerk, 62 W. Main, b.
 Gilbert Grove S. portrait painter, 99 Arcade, house Culver near Webster road

Gilbert Hattie H. widow, boards 6 E. Main near Stillson
 Gilbert Henry, laborer, 3 Canal, bds 14 do.
 Gilbert H. Roy, clerk, Brown c. Erie canal, house 54 Jones
 Gilbert John P. physician, 120 State, h. do.
 Gilbert Julia, widow, b. Smith cor. Orchard
 Gilbert Lewis C. mason, house 9 Alexander
 Gilbert Richard, engineer, Rochester Water Works, house 49 Goodman
 Gilbert Richard F. fireman, Rochester Water Works, boards 49 Goodman
 Gilbert Sarah, bds. East av. cor. Alexander
 Gilbert Thomas, shoemaker, 11 Elwood blk. house 44 Atkinson
 Gilbert Thomas, soap maker, house 21 Olean
 Gilbert Thomas jr. agent, boards 21 Olean
 Gilbert William, grinder, 136 Mill, house 4 Plymouth av. [27 State, h. 9 Park av.
 Gilbert Wm. Wallace, U. S. Commissioner,
 Gilbert William W. tucker, house 43 Platt
 Gilbo John, laborer, house 121 Champlain
 Gilboe Daniel, laborer, house 174 Scio
 Gilde John, carpenter, house 47 St. Joseph
 Gildea Michael, shoe cutter, 55 Mill, house 16 Shamrock [rock
 Gildea Michael jr. shoemaker, bds. 16 Sham-
 Gilder Lewis, hairdresser, 110 North av. h. 49 Davis [23 Oak
 Giles Addison A. clerk, 198 W. Main, bds.
 Giles Charles E. liquors, 198 W. Main, house 23 Oak [h. 17½ Gregory
 Giles George W. cabinetmaker, 22 S. St. Paul,
 Giles Mary, clerk, boards 23 Oak
 Giles Samuel, flour, &c. 210 West Main, h. 125 Caledonia avenue [Tremont
 Giles William, flour, 137 West Main, house 20
 Giles William B. clerk, 198 W. Main, boards 23 Oak
 Giles William H. clerk, b. 125 Caledonia av.
 Gilfoil Kate, domestic, boards 41 Scio
 Gilford Ann, widow, boards 164 West av.
 Gilgan Peter, carpenter, 97 Exchange, h. 1 Pear alley
 Gilgunn Ann, widow, house 115 Jones alley
 Gilgunn Hugh, farmer, bds. 115 Jones alley
 Gilgunn Mary, boards 115 Jones alley
 Gilkeson Benjamin F. physician, 57 State, house 41 Sophia
 Gill Bridget, widow, house 27 Vincent place
 Gill Calvin B. pump manuf. 129 Mill, house 1 Brisbane
 Gill James M. removed to Ilion [b. do.
 Gill Margaret, dressmaker, 27 Vincent place,
 Gill Michael, tailor, 79 State, house do.
 Gillam Frank, clerk, 16 N. St. Paul, boards 169 East Main [Jones
 Gillam Frank A. (*H. E. Gillam & Co.*), b. 130
 Gillam Harvey E. & Co. (*F. A. Gillam*), blacking manuf. 149 State, h. 130 Jones
 Gillam James J. cutter, 77 N. Water, house 7 William
 Gillam Maria Mrs. dressmaker, h. 134 State
 Gillard Christopher P. (*Lester & Gillard*), Mill near Factory, house 30 Romeyn
 Gillard Nathaniel, foreman, 15 Mill, h. 16 Magne [30 Romeyn
 Gillard Thomas S. salesman, 73 E. Main, b.

Gillespie Elizabeth, widow, boards Hague
 Gillett Ency J. widow, house 5 Chatham
 Gillett Frank W. clerk, house 174 State
 Gillett Moses B. physician, 321 State, h. do.
 Gillett Octavia, widow, boards 59 Fitzhugh
 Gillett Walter, student, bds. 210 Monroe av.
 Gillette Lorin H. lawyer, 108 Powers' build- ings, boards 24 Chestnut [h. do.
 Gilliard Valentine, saloon, 139 N. St. Paul,
 Gilligan John, tailor, 18 W. Main, house 44 St. Joseph
 Gilligan Joseph J. machinist, b. 44 St. Joseph
 Gilligan Mary, dressmaker, b. 136 S. St. Paul
 Gillin Barney, moulder, 20 Court, b. 21 Elm
 Gillis Edgar, baggage master, N. Y. C. & H. R. R. depot, house 42 North av.
GILLIS JAMES W. picture frames, 8 Allen, boards 65 Troup.—*See page 524*
 Gillis Julia, widow, house 65 Troup
 Gillis Julia Miss, clerk, 8 Allen, b. 65 Troup
 Gillis Rose, waiter, Whitcomb House, b. do.
 Gillis William, foreman, 8 Allen, h. 3 Favor
 Gillispie Kate, widow, bds. 135 S. St. Paul
 Gillman John C. switchman, Dean st. cross- ing, h. N. Clinton c. Vernon park
 Gillmore William J. shoemaker, h. 14 Oak- land park
 Gillson Henrietta M. boards 114 E. Main
 Gilman Alpha, carpenter, h. 70 Pinnacle av.
 Gilman David, carpenter, boards W. Troup near Frances
 Gilman Harvey E. painter, house 195 Scio
 Gilman Horace M. tailor, house 85 Clifton
 Gilman L. C. carpenter, bds. 10 Jones av.
 Gilman Mary A. Mrs. teacher, House of Refuge, boards 43 Allen
 Gilman Mary E. teacher, Genesee School, No. 4, boards 18 Prospect
 Gilman Robert, laborer, house 162 W. Main
 Gilman Sarah, widow, house West Troup n. Frances
 Gilmore Addison, student, bds. 32 Park av.
 Gilmore Fanny, Mrs. actress, bds. 96 Front
 Gilmore Jas. fancy goods, 20 N. Union, h. do.
 Gilmore Joseph H. professor, University of Rochester, house 26 Park av.
 Gilmore Thomas, gardener, b. Bates n. Sibley
 Gilmore William, nurseryman, house Bates near Sibley
 Gilmore William jr. carpenter, boards Bates near Sibley [land park
 Gilmour Wm. J. shoemaker, house 14 Oak-
 Gilroy Wm. M. sashmaker, foot N. Water, boards 60 N. St. Paul
 Gilson Julia E. teacher, Tremont School No. 3, boards No. 82 Fitzhugh
 Ginn Catharine, widow, house 69 Mahattan
 Ginter Charles, mason, house 3 Oakland park
 Ginter Frederick, cooper, 102 Childs, h. do.
 Ginter Frederick 2d, cooper, bds. 92 Childs
 Ginter Frederick 3d, cooper, bds. 108 Childs
 Ginter Henry, cooper, Magne opposite Wal- nut, house 108 Childs
 Ginter John, cooper, 102 Childs, house 92 do.
 Ginter John, hostler, bds. 100 Mt. Hope av.
 Girardin John B. salesman, 64 Mill, house at Detroit
 Giroux Joseph, conductor, N. Y. C. R. R.

- Girvin John, gardener, h. Flint cor. Seward
Gisselbach Christian, blacksmith, house 40½
Munger
- Givens James, card moulder, 114 Front b. do.
GIVENS THOMAS, show card moulder,
G 114 Front, boards do.—*See page 518*
- Givin Michael, mason, h. Terry n. Frances
Gladwish Charles, brakeman, h. 3 N. Stillson
Glaesel John W. laborer, house 30 Hoeltzer
Glantschnig Thomas, mason, h. 8 Widman
Glasco Alexander, laborer, 65 N. Water bds.
10 Green [N. Clinton
Glaser Charles, clerk, 81 State, boards 69
Glaser Florence S. bookkeeper, 81 N. Water,
boards 6 Chestnut park
Glaser Frederick M. clerk, 41 Andrews, bds.
Goodman near College avenue
Glaser George, bds. Goodman n. College av.
Glaser John M. carver, 184 State, b. 45 Kelly
Glaser Joseph, h. Goodman n. College av.
Glaser Lewis M. teamster, bds. 10 St. Joseph
Glaser Sarah, widow, house 6 Chestnut pk.
Glasgow Alexander, teamster, 65 N. Water,
boards 10 Green
Glasgow James, watchman, h. 112 Bartlett
Glasgow John, laborer, house 147 Fitzhugh
Glass John H. registers, 8 Plymouth avenue,
house at Gates
Glass Thomas, waiter, Osburn House, b. do.
Glasser Christopher (*Glasser & Bro.*), house
190 Jay
Glasser Enos A. shoemaker, h. 45 Gregory
Glasser George F. porter, 80 E. Main, bds.
Goodman near railroad
Glasser George M. (*Glasser & Bro.*), h. 121 Jay
Glasser Joseph, laborer, 8 Hill, bds. Jay n.
Wackerman [St. Joseph
Glasser Louis, teamster, 7 Atwater, house
Glasser Sebastian, clerk, b. Goodman n. R. R.
Glasser Susan, widow, h. Jay n. Wackerman
Glasser & Bro. (*C. and G. M. Glasser*), boots
and shoes, 121 Jay [h. 82 Lyell
Glathar Frederick, chairmaker, 7 N. Water,
Glatt Frederick, brewer, 106 N. Clinton, b. do.
Glatt John, laborer, house 256 St. Joseph
Glavey James H. machinist, 138 Mill, house
27 Munger [n. Seward
Glavin Bridget Miss, tailoress, bds. Cottage
Glavin Edward, gardener, house 6 Munger
Glavin Edward, teamster, boards Cottage n.
Seward
Glavin John, painter, house 14 Vincent place
Glavin Patrick, laborer, h. r. 3 Brown's alley
Glavin Patrick, laborer, house 72 Campbell
Glavin Thomas, milkman, house Plymouth
avenue near canal
Glavin William, laborer, house Cottage cor.
Seward [1 Bolivar
Glazier Elias C. lampmaker, 118 Mill, house
Gleason Dennis, stonemason, h. 84 Atwater
Gleason Elizabeth B. widow, h. 45 Court
Gleason F. Edward, civil engineer, house 45
Court
Gleason Geo. G. civil engineer, b. 45 Court
Gleason Harry B. draughtsman, 64 Arcade,
boards 45 Court
Gleason James, grocer, University avenue c.
Anderson avenue, house do.
- Gleason James J. clerk, 79 East Main, bds.
University avenue c. Anderson av.
Gleason Marcello R., boards 20 Alexander
Gleason Mary, widow, boards 42 Platt
Gleason Thomas, machinist, bds. 84 Atwater
Gleason Thomas C. machinist, 100 South St.
Paul, house 20 Alexander
Gleason Thomas F. machinist, Brown's race
near Furnace, bds. 42 Platt
GLEASON WILLIAM, proprietor Kidd
Iron Works, Brown's race n. Furnace,
house 42 Platt.—*See page 686*
Gleason William, laborer, h. West alley near
West Main [h. 125 Adams
Gledhill Thomas, stone cutter, 8 West av.
Gleeson James, yardmaster, N. Y. C. depot,
house 62 Brown
Gleeson J. Henry, deceased 1875
Gleeson Kate Mrs. widow, house 18 Spencer
Gleichauf Albert, melter, 187 West Main, h.
38 Rhine
Gleichauf Bernhard, maltster, h. 39 Sanford
Gleichauf Frank X. currier, h. Hollenbeck
Gleichauf John, grocer, 89 Monroe avenue,
house Meigs c. Harvard [Ontario
Gleichauf John B. laborer, 2 Hill, house 50
GLEICHAUF JOHN B. pumppmaker, 37
G Sanford, house do.—*See page 643*
Gleisle Mary Ann, widow, house 93 Kelly
Gleisle Geo. cabinetmaker, 69 N. St. Paul, b.
93 Kelly
Glen Brothers (*E. and J. G. Glen*), nursery
stock dealers, East avenue n. Goodman
Glen Elijah M. b. East avenue n. Goodman
Glen Eugene (*Glen Bros.*), house Hawthorn
east side [b. 11 Stillson
Glen Frank E. teacher, Free Academy,
Glen G. Smith, nurseryman, bds. 15 Arnold
park [h. 11 Stillson
Glen Hezekiah G. engineer, N. Y. C. R. R.
Glen John G. manager Glen & Hall Manuf.
Co. S. Water (*and Glen Bros.*), b. Haw-
thorn near East avenue
GLEN & HALL MANUF. CO. agricultural
implements, South Water, n. E. Main.—
See page 675 [105 Fulton avenue
Glenn Eliza, paperfinisher, Paper Mill, bds.
Glenn Mortimer, kindling wood, h. Litch-
field near Brown
Glennon Ellen M. widow, b. 107 Atkinson
Glick Anthony J. shoemaker, h. 39 Rhine
Glick John, mason, house Carter n. North av.
Glick John W. saloon, North avenue near
Jennings, house do.
Gliddon Charles A. engineer, h. 39 Hudson
Gliddon Thomas, foreman, Evening Express
job office, 23 West Main, bds. 38 Bolivar
Glienke Charles, cabinetmaker, 133 North
Water, house 19 Scrantom
Glienke Leo G. scroll sawyer, Aqueduct, b.
19 Scrantom [Water, h. 19 Scrantom
Glienke William C. cabinetmaker, 133 North
Glinkie Frank, carver, 7 North Water, boards
99 South avenue
Glinkie Henry, cabinetmaker, h. 99 South av.
Glicht Charles, painter, house 3 Gregory
Glicht Sebastian, painter, house 3 Gregory
Glitsch Kate E. tailoress, boards 53 Weld

Glotzbach John, gasfitter, 25 Exchange, h. 50 Hickory [176 do.
 Glover Alanson D. painter, 207 E. Main, h.
 Glover Allie S. teacher, Munger school, No. 13 boards 34 Pearl
 Glover Charles, house 52 Broadway
GLOVER CHARLES, agent for D. Appleton & Co. 42 State, house 33-Court.—See page 593
 Glover Edwin A. clerk County clerk's office, Court House, boards 89 Alexander
 Glover George A. bookkeeper, house 34 Pearl
 Glover James M. carriage trimmer, 3 Canal, house 372 Brown
 Glover Mrs. widow, h. Bismarc n. Genesee
 Gloyd Ellen, widow, house 166 Exchange
 Gluck Ernest J. carver, 184 State, house 49 Orchard
 Glueck Frederick, h. St. Joseph n. Norton
 Glueck John, blacksmith, house 2 Sellinger
 Gluelich Albert, teacher, St. Joseph's school, boards 18 Franklin
 Glunz Caspar, painter, house 52 Saxton
 Glynn Kate, widow, boards 69 Manhattan
 Glynn Mary, house 85 Mt. Hope avenue
 Gmelin Emil, baker, 262 State, h. 26 Kelly
 Gnaedinger Sebastian, coppersmith, Platt, h. 68 Nassau [house 11 Selden
 Goddard Lewis J. lawyer, 71 Powers' bldgs.
 Goddard Rosa G. Mrs. teacher, Andrews school, No. 9, bds. 76 University avenue
 Goddard Susan A. boards 7 Fitzhugh
 Goddard William G. laborer, h. 15 W. Troup
 Goddard William S. laborer, h. 97 Hunter
GODFREY GEORGE W. & CO. photographers, 81 E. Main, b. do.—See page 522
 Godfrey James M. tailor, house 218 W. Main
 Godfrey Louis, tailor, rear 28 Stone, house 44 North Water
 Godfrey M. B. boards Chapman House
 Godley Lilla A. Miss, removed to Ludlowville
 Godley Pierson M. deceased Dec. 1875
 Godley Sophia B. widow, boards 114 Lake av.
 Godwin Anson, deceased June, 1875
 Godwin Charles, laborer, bds. 65 Monroe av.
 Godwin Jane, widow, house 65 Monroe av.
 Goebel Geo. blacksmith, h. 201 St. Joseph
 Goebel Joseph, cigarmaker, h. 1 Ringlestein al.
 Goebel Joseph A. cigarmaker, h. 1 Ringlestein alley [alley
 Goebel Martin, cigarmaker, b. 1 Ringlestein
 Goebel Martin, mason, h. Henrietta av. near Pinnacle avenue
 Goebel, see Gabel
 Goedel Charles, grocer, 119 Lyell, house do.
 Goerger John, cabinetmaker, 133 N. Water, boards 169 Jay
 Goers August, laborer, house 52 Sanford
 Goers Robert W. lampmaker, 3 Canal, bds. 159 St. Joseph [house do.
 Goers Theodore, grocer, Hudson cor. Rhine,
 Goesele Frances, clerk, 116 St. Joseph, b. do.
 Goesele Simon, laborer, house 19 Woodbury
 Goetchius Henrietta Mrs. milliner, 81 E. Main, boards 111 Lake avenue [North av.
 Goettel Charles, tailor, 92 Arcade, house 93
 Goetting Eliza, widow, house 23 Holland
 Goetz Bartholomay, house 74 Kelly

Goetz Charles, mason, house 86 St. Joseph
 Goetz Charles, mason, house 74 Kelly
 Goetz Dorothea Mrs. midwife, h. 74 Kelly
 Goetz Eugene, laborer, house 60 Weld
 Goetz Francisca, widow, h. Hudson c. Clifford
 Goetz George F. shoemaker, 20 Catharine, boards 97 Chatham [b. 336 N. Clinton
 Goetz George M. hairdresser, 86 St. Joseph,
 Goetz Josephine, widow, house 97 Chatham
 Goetz Louis, stonecutter, 8 West av. boards 74 Kelly
 Goetz Simon, butcher, 16 Front, bds. 60 Weld
 Goetze Charles, saloon, 57 Lyell, house do.
 Goetze Charles jr. artist, 155 West Main, bds. 57 Lyell [iversity avenue
 Goetzman Elizabeth, widow, house 39 Uni-
 Goetzmann E. (*Goetzmann & Son*), house 347 Brown
GOETZMANN FREDERICK, distiller, wines and liquors, 9 Atwater, house 6 St. Joseph.—See page 562
 Goetzmann Frederick, wagonmaker, 170 St. Joseph, house 336 North Clinton
 Goetzmann Frederic G. student, boards 6 St. Joseph [347 Brown
 Goetzmann Fred. W. (*Goetzmann & Son*), b.
 Goetzmann Gottlieb, soapmaker, Wentworth corner New York, house 347 Brown
GOETZMANN HENRY, vinegar maker and ice dealer, 19 Pinnacle avenue, house 20 do.—See page 555
 Goetzmann Sarah, widow, b. Clifford near Hudson
 Goetzmann & Son (*E. and F. W. Goetzmann*), soap manufs. Wentworth cor. New York
 Goff Catharine, Miss, boards 74 N. Clinton
 Goff Charles W. deceased, Jan. 26, 1876
 Goff Frank, student, 77 Powers' bldgs. bds. at Spencerport
 Goff Willard L. sawyer, 92 Allen, h. Walnut near Orange
 Goffronn William, removed to Buffalo
 Goggin Edward, tinsmith, 90 East Main, bds. 36 Stone [60 N. Clinton
 Goggin George, clerk, 77 East Main, boards
 Goggin Josie A. Mrs. teacher, Atwater school, No. 10, boards 89 South Union
 Goggin William E. (*Goggin & Jones*), house 60 North Clinton [b. 60 N. Clinton
 Goggin William E. jr. clerk, 77 East Main,
 Goggin & Jones (*W. E. Goggin and Edward Jones*), hats, caps, &c. 77 East Main
 Gohr August, mason, house 71 Kelly
 Golberg Simon, deceased, Oct. 1875
 Goldbach H. Jerome, sawyer, 71 North St. Paul, house 282 North Clinton
 Goldbach Joseph, baker, 240 N. Clinton, b. do.
 Goldbach Joseph J. bartender, 42 Allen, b. do.
 Goldbach Odilia, widow, boards Hague
 Goldbach Simplicius, laborer, N. Ford near Hill, house Hague n. R. R. [Pleasant
 Goldberg Samuel, clerk, 49 E. Main, bds. 16
 Golden John, laborer, house 187 Champlain
 Golden Martin, laborer, house 181 Champlain
 Golden Michael, shoemaker, 15 Mill, house 32 Romeyn
 Golden Michael, laborer, house 14 Ely
 Golden Walter B. removed from city

HENRY C. WISNER,

DECORATED CHINA, SILVER SETS,
 No. 33 STATE STREET,

- Golden Patrick, gardener, h. 82 Broadway
 Golding Daniel, saloon, 66 Front, house do.
 Golding Daniel jr. tinsmith, h. 7 Shamrock
 Golding Samuel, agent, h. Vincent place n.
 N. St. Paul
 Golding, see Goulding
 Goldsmith Bros. (*Max and Simon Goldsmith*),
 dry goods, 85 St. Joseph
 Goldsmith Ella, domestic, 9 White [O.
 Goldsmith Joseph A. removed to Cleveland,
 Goldsmith L. Mrs. boards 6 Rome
 Goldsmith Matilda, widow, house W. Maple
 corner Hague
 Goldsmith Max (*Goldsmith Bros.*), 85 St.
 Joseph, house 34 Kelly
 Goldsmith Saly, clerk, 85 St. Joseph, boards
 34 Kelly [Joseph, bds. 34 Kelly
 Goldsmith Simon (*Goldsmith Bros.*), 85 St.
 Goldstein David, peddler, boards 5 Herman
 Goldwater Isaac, peddler, house 14 Pryor
 Goldwater Moses (*N. Goldwater & Bro.*) h.
 134 St. Joseph [134 St. Joseph
 Goldwater Nathan (*N. Goldwater & Bro.*) h.
 Goldwater Sander, house 5 Herman
 Goldwater Simon, peddler, bds. 5 Herman
 Goldwater N. & Bro. (*N. & M. Goldwater*),
 dry goods, 134 St. Joseph
 Goler George W. (*Curran & Goler*), 96 West
 Main, h. West avenue n. Ames
 Goler John, laborer, h. Magnolia n. Frances
 Golley Henry, removed to Buffalo
 Gomm George, lockfinisher, Court c. Stone,
 house 49 Clinton place [66 Oak
 Gomm William, machinist, 123 Mill, house
 Gommenginger Bartholomew, 48 Exchange,
 house Goodman opp. E. Main
 Gommenginger Bartholomew J. plumber, b.
 36 Orange [Orange
 Gommenginger Jacob, switchman, house 36
 Gommenginger Jacob G. (*Gommenginger &
 Co.*) h. N. Clinton n. Bloomingdale av.
 Gommenginger John J. tinsmith, 48 Ex-
 change, h. Gorham [h. 36 Hand
 Gommenginger Joseph, policeman, City Hall,
 Gommenginger Lewis, policeman, City Hall,
 house Adams near Reynolds
 Gommenginger Theresa, h. Goodman corner
 Schanck avenue
GOMMENGINGER & CO. (*J. G. Gommen-
 ginger*), furnaces and iron roofing, 48
 Exchange.—*See page 617*
 Gomminger J. Louis, tailor, 28 McDonald
 avenue, bds. 69 Chatham
 Gomo Jacob, mason, house 298 N. Clinton
 Gongloff John, glassblower, 178 Plymouth
 avenue, bds. 168 do.
 Gonter Ella, paperworker, 32 N. Water, bds.
 69 South Union
 Gonter Lavinia, widow, h. 69 South Union
 Gonzaga Sister, teacher, bds Jay c. Frank
 Good Adam, blacksmith, Court cor. Stone,
 bds. 102 Scio [102 Scio
 Good James, laborer, Court co. Stone, house
 Good James, gardener, h. Park av. n. Brown
 Good Thomas, lockmaker, Court cor. Stone,
 boards 102 Scio
 Good, see Guth [308 E. Main
 Goodale Charles C. (*Goodale & Pells*), house
 Goodale Fred. W. stenographer, 77 Powers'
 buildings, bds. Clinton Hotel
 Goodale & Pells (*C. C. Goodale and A. V.
 Pells*), lamps, oils &c. 63 West Main
 Goodell Anna, widow, h. 9 Elizabeth
 Goodell Charles, clerk, 11½ Spring, bds. 9
 Elizabeth
 Goodell Emma, widow, h. 12 Sibley's block
 Goodell Theresa, dressmaker, b. 8 Chatham
 Goodell Wm. student, 94 Powers' bldgs. bds.
 121½ East Main [av. house do.
 Goodenough Charles, upholsterer, 74 West
 Goodenough David, deceased April 1, 1876
 Goodenough Edmund H. thermometer maker,
 3 Hill, house 10 Campbell
 Goodenough John, carpenter, house 73 Jay
 Goodenough Sarah, widow, h. 94 Campbell
 Goodger Henry, shoemaker, Jay cor. State,
 house 54 Bolivar
 Goodger James W. moulder, h. 11 Costar
 Goodger John H. jeweller, 295 State, boards
 54 Bolivar
 Goodger Margaret, stitcher, bds. 11 Costar
 Goodhue Allen J. (*Keller & Goodhue*), 87 N.
 Water, house 8 Matthews
 Goodin Edmund, framemaker, 38 Gorham,
 house 244 North avenue
 Goodland Charles, tanner, house 21 Tappan
 Goodman Daniel, carman, house 30 Orange
 Goodman Experience K. widow, h. Goodman
 near University av. [University av.
 Goodman George H. boards Goodman near
 Goodman George W. woodworker, 4 Hill, b.
 8 North Ford [Ford
 Goodman Harriet E. boarding house, 8 N.
 Goodman James, carpenter, 39 S. Ford, h.
 141 Tremont [Broadway
 Goodman James R. clerk, 15 Exchange, h. 27
 Goodman Jonas, cutter, 76 Mill, house 100
 South avenue [avenue
 Goodman Louis, salesman, boards 100 South
 Goodman Mary, widow, house 92 Fitzhugh
 Goodman Mary A. Mrs. house 30 Orange
 Goodman Moses, clerk, 11 State, boards 58
 North St. Paul
 Goodman Richard, clerk, 23 Spring, b. 24 do.
 Goodman Susan, widow, house 27 Broadway
 Goodman William, engineer, N. Y. C. R. R.
 boards 13 Jones
 Goodnow George S. removed to Hudson,
 Michigan [26 Asylum
 Goodrich Adolphus S. clerk, 13 E. Main, b.
 Goodrich Alfred L. removed to Rio Janerio,
 S. A. [W. Main, house 61 Andrews
 Goodrich Fred. (*Goodrich & Witherspoon*), 8
 Goodrich Jane, widow, bds. 203 Exchange
 Goodrich Judith, widow, boards 44 Court
 Goodrich Margery, widow, h. 10½ Chestnut pk.
 Goodrich William P. student, b. 61 Andrews
 Goodrich & Witherspoon (*F. Goodrich and
 W. E. Witherspoon*), tailors, 8 W. Main
 Goodwin Catharine, stitcher, b. 52 Reynolds
 Goodwin Frank E. (*Goodwin & Bishop*), h.
 24 Adams
 Goodwin Frank J. fireman, house 142 North
 avenue [Bank, bds. 32 South
 Goodwin Frank J. 2d, clerk, Traders' Nat.
 Goodwin Henry, painter, 20 Park av. h. do.

A. R. PRITCHARD & LIKLY,

SOLID RED CEDAR TRUNKS,
No. 78 STATE STREET.

Goodwin Henry E. paints and oils, 202 State, house 45 Lake avenue
 Goodwin James, cartman, h. 15 Saratoga av.
 Goodwin Jennie A. widow, house 154 Scio
 Goodwin Louisa Miss, boards 45 Lake av.
 Goodwin Mary, widow, boards 134 North av.
 Goodwin Mary, widow, house 256 North
 Goodwin Mary E. Mrs. house 32 South
 Goodwin Virgil C. (*Goodwin & Mason*), bds. Wood's building
 Goodwin Wm. H. fireman, house 256 North
 Goodwin Wm. H. painter, 202 State, boards 45 Lake avenue
GOODWIN & BISHOP (*F. E. Goodwin and F. B. Bishop*), boots and shoes wholesale, 109 State.—*See page 664*
GOODWIN & MASON (*V. C. Goodwin and J. C. Mason*), carriage repository, Wood's building, Fitzhugh.—*See page 602*
 Goodyear Joshua B. turner, 3 Elizabeth, h. 30 Litchfield [72 Champlain
 Goodyear Wm. H. foreman, 73 N. Water, h. Goodyear see Goodger
 Gould Addie, widow, house 29 Madison
 Gooney Michael, flagman, Scio st. crossing, boards Davis
 Gorbutt George, teamster, bds. 11 Alexander
 Gordinier E. Dayton (*Swift & Gordinier*), 335 State, boards do.
 Gordinier Hannah, widow, house 27 Scio
 Gordinier Nicholas, deceased March 6, 1876
 Gordinier Sarah A. widow, house 335 State
GORDON ADDISON J. manager New Jersey Mutual Life Insurance Co. 18 West Main, house Nunda.—*See page 506*
 Gordon Alexander, manager Rochester Agricultural Works, 100 South St. Paul, h. 300 East Main
 Gordon Alexander, deceased May 2, 1876
 Gordon Andrew O. saloon, 13 Arcade, house 50 Pearl [40 Kent
 Gordon Catharine, button-hole worker, house
 Gordon Charles (*Hathaway & Gordon*), 65 N. Water, house 31 Andrews
 Gordon Charles F. salesman, 73 E. Main, b. 5 N. Washington
 Gordon David M. (*Brewster, Gordon & Co.*), 80 East Main, boards 81 Fitzhugh
 Gordon David S. carpenter, bds. 31 Andrews
 Gordon Edward Y. draftsman, 20 W. Main, boards 170½ do.
 Gordon George V. removed from city
 Gordon Hannah, widow, h. 134 Frost avenue
 Gordon Harriet Miss, h. 119 Mt. Hope av.
 Gordon Harvey D. bookkeeper, house College avenue cor. Prince [h. 45 Marshall
 Gordon Henry R. (*Gordon, Van Zandt & Co.*),
 Gordon Herbert W. salesman, Allen c. North Washington, boards 61 Lake avenue
 Gordon James F. agricultural implements, r. 136 Mill, house 58 Caledonia av.
 Gordon Janet, widow, boards 40 Kent
 Gordon John H. clerk, b. Hook and Ladder house, 61 Front
 Gordon Mary G. Mrs. boards 17 Stone
 Gordon Norman, paper hanger, h. 2 Harrison
 Gordon Prudie H. teacher, Munger School, No. 13, boards 37 Brown

Gordon Robert H. produce, 79 S. St. Paul, house 115 Monroe av. [34 Channing
 Gordon Robert M. shoemaker, 4 Allen, house
 Gordon Stephen D. engineer, N. Y. C. R. R. house 37 Brown
 Gordon, Van Zandt & Co. (*H. R. Gordon, I. W. Van Zandt and M. B. King*), extracts, 50 Exchange [Peoria
 Gordon Wm. salesman, 31 Exchange, h. at
 Gordon Wm. engineer, house 64 North av.
 Gordon Wm. H. painter house 10 Fehner
 Gordon ———, boards 104 South St. Paul
 Gore Agnes M. Miss, milliner, bds. 24 Allen
 Gore Augustus W. clerk, 65 State, boards 24 Allen
 Gore Maria, widow, house 24 Allen
 Gores Joseph, carpet weaver, b. 91 N. Clinton
 Gorham Charles H. lawyer, 23 Powers' bldgs. house at Brighton [13 Scio
 Gorham Jessie C. H. copyist, 93 State, bds.
 Gorham Julia A. widow, house 13 Scio
 Gorman Anna, widow, house 26 Hill
 Gorman Ellen M. paster, boards 21 Lyell
 Gorman John, carpenter, house 13 West
 Gorman John F. machinist, Mill c. Platt, h. 120 Atkinson
 Gorman Mary, widow, house Frank c. Brown
 Gorman Mary A. polisher, boards 21 Lyell
 Gorman Michael J. painter, boards Brown c. Frank [Frank
 Gorman Thomas, laborer, boards Brown c.
 Gorman Wm. tobacco worker, 25 W. Main, boards 9 Caledonia av.
 Gormly Hannah M. widow, house 9 Meigs
 Gormly John, bookkeeper, 52 East Main, b. 9 Meigs
 Gormly Samuel J. boards 9 Meigs
 Gormly Thomas A. salesman, 73 E. Main, b. 39 North St. Paul [St. Paul
 Gormly William M. clerk, 42 State, b. 39 N.
 Gormly Wm. R. salesman, 64 State, boards 9 Meigs [149 N. Clinton
 Gornell George, book binder, 29 W. Main, h.
 Gorsline Alfred, currier, 130 Front, b. York House
 Gorsline Aurelia, widow, boards 33 Pearl
 Gorsline Charles, carpenter, west end Court street bridge, house 10 Averell
 Gorsline James, tanner, house Lake avenue near Ridge road
 Gorsline Salmon, mason, house 36 Pearl
 Gorsline Wm. H. mason, and (*Otis & Gorsline*), 51 Powers' bldgs h. 97 Alexander
 Gorton Charles W. student, University of Rochester, bds. 41 Plymouth av.
 Gorton Francis, pres. Flour City Nat. Bank, 1 Powers' bldgs. h. 41 Plymouth av.
 Gorton Harry C. ass't. bookkeeper, 1 Powers' buildings, boards 41 Plymouth av.
 Gorton Homer, detective, b. 9 Hamilton pl.
 Gorton John, deceased August 25, 1875
 Gorton John jr. house 51 Chestnut
 Gorton Warren, miller, Washington mills, h. 20 Lyell
 Gosele Gottlieb, tobacconist, house 57 Kirk
 Gosele Jacob, blacksmith, boards 127 Scio
 Gosele Rosanna, widow, house 127 Scio
 Gosele Rudolph, tobacconist, bds. 127 Scio

Gosele Samuel, blacksmith, boards 127 Scio
 Gosnell Daniel, cooper, Finney c. Davis, h.
 10 Ontario
 Gosnell Esther, widow, boards 19½ Kirk
 Gosnell Fred. yardman, Whitcomb House,
 boards do.
 Gosnell James, laborer, boards 2 Kirk
 Gosnell James jr. painter, 128 North, boards
 9½ Kirk
 Gosnell James, cartman, house 73 Atkinson
 Gosnell James, laborer, house 9½ Kirk
 Gosnell James, mason, boards 19 Ontario
 Gosnell James W. clerk, boards. 9 Kirk
 Gosnell John, carpenter, rear 4 Kirk, house
 19 Ontario
 Gosnell John, laborer, house 9 Kirk
 Gosnell John, painter, 128 North av. boards
 9½ Kirk
 Gosnell John, house 2 Kirk [h. 1 Finney
 Gosnell John G. shoemaker, 75 N. Water,
 Gosnell Samuel, laborer, 208 North
 Gosnell Samuel jr. carpenter, b. 208 North
 Gosnell Thomas, cooper, Magne near R. R.
 boards 208 North
 Gosnell William, shoemaker, Monroe avenue
 corner Marshall, house 43 Kirk
 Goss Charles, shoemaker, h. 118 Campbell
 Goss Charles C. shoemaker, b. 118 Campbell
 Goss Ignatius, sawyer, 3 Canal, bds. 118
 Campbell
 Goss John W. (*Pollock Weaver & Co.*), 17 W.
 Main, h. 8 Goodman [h. 68 Kent
 Goss Samuel (*Goss & Margrander*), 53 State,
 Goss William H. clerk, 53 State, b. 68 Kent
 Goss & Margrander (*S. Goss and J. Mar-*
grander), upholsterers, 53 State
 Gosselin Frank G. carpenter, boards Bolivar
 corner Smith [corner Smith
 Gosselin Helena, dressmaker, boards Bolivar
 Gosselin John, carpenter, Brown cor. Jones,
 h. Bolivar corner Smith
 Gosselin John T. carpenter, Brown c. Jones,
 house 51 Smith [44 Oakland park
 Gosson Thomas, clerk, 25 S. St. Paul, house
 Gosson Thomas H. printer, 1 Aqueduct, bds.
 45 Mt. Hope avenue
 Gosson William J. pressman, 23 W. Main,
 boards 45 Mt. Hope avenue
 Gottermeyer Frank, machinist, Stewart's
 building, house 44 Walnut
 Gottry Samuel, trunkmaker, boards 38 Platt
 Gottschalk Carl L. deceased June 12, 1875
 Gottschalk Catharine, widow, h. 67 Univer-
 sity av. [Factory, house 11 Nassau
 Gottschalk Charles F. cigar maker, Mill cor.
 Gottschalk Ferdinand, laborer, 255 N. St.
 Paul, house on flats N. St. Paul
 Gottschalk Frederick, laborer, boards 26
 Wadsworth
 Gottschalk Frederick, jr. cabinetmaker, bds.
 26 Wadsworth
 Gottschalk William C. shoemaker, 92 State,
 boards on flats North St. Paul
 Gould Amos, master mechanic, N. Y. C. R.
 R. Brown, house 13½ Marietta

GOULD BROS. (*E. P. and S. H. Gould*),
 Monroe Co. Nurseries, East avenue near
 Brighton.—See back cover

Gould Edgar G. salesman, 73 E. Main, bds.
 190 N. St. Paul [Alexander
 Gould Edward P. (*Gould Bros.*), house 103
 Gould Elizabeth P. widow, h. 1 Trowbridge
 Gould Fred. E. clerk, Exchange opp. Glas-
 gow, boards 93 Plymouth avenue
 Gould Geo. & Son (*J. H. Gould*), boots and
 shoes, 16 State, h. 46 Sophia [Alexander
 Gould Guilford D. nursery stock, house 143
 Gould Jacob S. boards 59 Fitzhugh
 Gould James, miller, boards 274 State
 Gould James, fireman, N. Y. C. R. R. house
 76 Jay [Sophia
 Gould James H. (*G. Gould & Son*), boards 46
 Gould Joel & Son (*Roscius K. Gould*), livery
 stable, 11 Andrews, house 22 John
 Gould Linsley M. grocer, house 1 Trowbridge
 Gould Mary T. Mrs. dressmaker, h. 22 John
 Gould Roscius K. (*J. Gould & Son*), house 22
 John [R. R. crossing
 Gould Samuel P. farmer, h. East avenue n.
 Gould S. Hatch (*Gould Bros.*), East avenue n.
 R. R. crossing, house Brighton village
 Gould Theodore B. (*Gould & Co.*) boards 1
 Trowbridge
 Gould William, mason, house 64 Prospect
 Gould William, gardener, h. Sibley n. Culver
 Gould William, engineer, N. Y. C. R. R. h.
 190 North St. Paul
 Gould Wm. T. jr. house 76 Cady [av.
 Gould & Co. (*T. B. Gould*), grocers, 29 West
 Goulding George P. (*Goulding & Co.*), 30
 Lake avenue, house do. [Paul
 Goulding Thomas, boarding house, 96 S. St.
 Goulding & Co. (*G. P. Goulding and E.*
Hart), bottlers, 30 Lake avenue
 Gove Charles (*W. R. Caulkins & Co.*), 32
 East Main, h. at Charlotte [49 Frank
 Govern Peter, cabinetmaker, 184 State, bds.
 Govro Louis, packer, 149 State, house do.
 Gow Alonzo D. cigarmaker, b. 133 Frank
 Gow John N. blacksmith, Brown c. Jones,
 house 157 Wilder
 Gow Maria, widow, house 133 Frank
 Gow Mary E. clerk, boards 133 Frank
 Graaf George, removed to New York City
 Graalman Edward, student, Rochester The-
 ological Seminary, bds. 118 Alexander
 Grab Adam, wood moulder, lower falls, bds.
 rear 2 Perkins
 Grab Henry, teamster, house 36 Whitney
 Grab John, packer, 101 State, h. 1 Thompson
 Grab Joseph, cooper, house 32 Grape
 Grace John, removed to Susquehanna, Pa.
 Grace Thomas, engineer, N. Y. C. R. R. h.
 176 Brown
 Gradl Andrew, laborer, boards 73 Saxton
 Gradl Anna, seamstress, boards 73 Saxton
 Gradl Joseph, shoemaker, house 73 Saxton
 Grady Patrick, salesman, 53 E. Main, bds.
 22 Frank [ings, b. 6 Pleasant
 Graebe William, lawyer, 36 Powers' build-
 Graf Anna M. widow, house 61 Nassau
 Graf Christian, coppersmith, 118 Mill, house
 10 Baden
 Graf Frederick, combmaker, h. Mill c. Brown
 Graf John H. laborer, h. 9½ Bay [Saxton
 Graf Margaret, widow, h. W. Maple corner

Graf Moritz, deceased March, 1876
 Graff Frederick W. cigarmaker, boards Mill corner Brown
 Graff Henry, laborer, boards 91 Front
 Gragan Hugh, laborer, house 129 S. St. Paul
 Gragan James, foreman, house Mt. Hope av. near Mt. Hope [Paul, h. 101 Meigs
 Gragan William C. tobacco cutter, 55 S. St.
 Graham Alexander, printer, h. 10 W. Troup
 Graham Bridget, widow, h. 35 Brown blk.
 Graham Daniel, teamster, house 40 Lake av.
 Graham George H. pattern maker, Clinton Mills, house 215 N. St. Paul
 Graham Hugh, laborer, h. r. 100 S. St. Paul
 Graham Hugh jr. shoemaker, b. r. 100 South St. Paul [Exchange
 Graham James, clerk, 64 State, boards 62
 Graham James J. insurance agent, 28 Powers' buildings, boards 20 East avenue
G. GRAHAM JAMES S. & CO. (*John Kane*), woodworking machinery, Mill n. Factory, house Ambrose c. Frank. — See page 672
 Graham John A. carpenter, house 187 Lyell
 Graham John C. coachmaker, 3 Canal, bds. 36 Prospect
 Graham John R. cabinetmaker, h. 17 Greig
 Graham Kate T. fancy goods, 91 East Main, boards 65 North avenue
G. GRAHAM LARASHA D. carpenter, house 23 Ontario cor. Finney. See page 590
 Graham Lewis, laborer, Lyell c. West, house 9 West [102½ Allen
 Graham Margaret Miss, music teacher, bds.
 Graham Mary jr. widow, house 35 Lancaster
 Graham Mary A. Mrs. house 35 Hudson
 Graham Rosa A. widow, house 65 North av.
 Graham Thomas, marble dealer, h. 26 Vick park
 Graham William H. waiter, bds. 95 Clifton
 Grahl Henry, mechanic, 179 N. St. Paul, house St. Joseph near Kelly
 Grainger James K. market, 89 S. St. Paul, h. 65 William [bds. 65 William
 Grainger Wm. A. bookkeeper, 26 Mumford
 Gramby Albert, cooper, house 1 Helena
 Gramlich Edward, blacksmith, 136 Mill, h. 9 Thomas [Smith, h. 41 Hanover
 Gramlich Valentine, stone cutter, Oak cor.
 Grandcolin Constant, cook, Osburn House
 Granger Charles, mattress maker, 74 State, house 55 Frances [bds 11 Joiner
 Granger Charles H. bookkeeper, 82 W. Main,
 Granger Francis E. (*Granger & Chapman*), 19 Marietta, boards 11 Joiner
 Granger Henry R. laborer, Erie Railway freight house, house 74 Champlain
 Granger Jane, widow, house 1 Sheridan pk.
 Granger Lyman H. house 11 Sophia
 Granger Mary J. paper box maker, 205 Plymouth avenue, house 47 Bartlett
 Granger Robert E. polisher, bds. 47 Bartlett
 Granger Seth, house 15 Elm
 Granger William, mason, house 6 Delevan
 Granger & Chapman (*Francis E. Granger and Herbert W. Chapman*), printers, 19 Marietta [Kirk
 Granning Charles T. blacksmith, boards 61

Granning John J. laborer, house 61 Kirk
 Grant Cecilia H. Miss, house 32 Andrews
 Grant George J. broom maker, Reynolds corner Champlain, boards 98 Bartlett
 Grant J. Herbert, civil engineer, boards Waverly House [avenue
 Grant Libbie Miss, domestic, bds. 66 Monroe
 Grant Minnie Miss, house 13 Division
 Grant Ranald, blacksmith, Alexander near Broadway, house 75 Broadway
 Grant Thomas, mason, house 98 Bartlett
 Grant Winfield S. clerk, boards 83 Lake av.
 Grantman Jacob F. tailor, Sellinger near St. Joseph, house do. [Clinton
 Grantman John, laborer, house 121 North Grantsynn Wm. S. removed to Greece
 Grapenstetter Edward, moulder, 8 Hill, bds. 68½ Hunter [68½ Hunter
 Grapenstetter Moses, moulder 8 Hill, house
 Grassman George, laborer, house 94 Hunter
 Gratton Thos. shoemaker, 87 N. Water, bds. 4 Hart's block
 Gratz Hulda, domestic, boards 81 Meigs
 Graule Barbara, widow, house 33 Bond
 Graule Frank, whip maker, Allen near North Washington, boards 33 Bond [Genesee
 Graus Michael, laborer, h. McLean pk. near
 Grauwiller David T. sash maker, 7 W. Main, boards 3 Weld
 Grauwiller Elizabeth, widow, house 3 Weld
 Grauwiller John J. sash maker, 7 W. Main, boards 3 Weld
 Gravell Edward, laborer, S. St. Paul opposite Griffith, h. 53 Front
 Graven Gerret, shoemaker, h. Hudson near Berlin [Berlin
 Graven Henry, carpenter, h. Hudson near
 Graves Andrew, coachman, h. Sibley near East avenue
 Graves Betsey, widow, house 45 Allen
 Graves Charles G. shoemaker, 73 N. Water, house Hudson near Berlin [45 Allen
 Graves Edson H. telegrapher, 151 State, h.
 Graves Frederick, laborer, h. r. 22 Gregory
 Graves Fred. B. bookkeeper, Mill c. Factory, boards 71 Lake avenue [12 N. Water
 Graves George C. carpenter, 3 Aqueduct, b.
 Graves George W. salesman, b. 6 Chestnut
 Graves Giles W. carpenter, 97 Exchange, h. 11 Martin
 Graves James, mason, house 80 S. St. Paul
 Graves John F. removed from city
 Graves John H. insurance, house 6 Chestnut
 Graves John W. confectioner, 39 Exchange, house 6 Gardiner park
G. GRAVES LORENZO S. boot and shoe machinery, Mill corner Factory, house 71 Lake avenue. — See page 690
 Graves Lyman, foreman, h. 296 Monroe av.
 Graves Mary, widow, house 22 N. Water
 Graves Mary A. widow, house 80 S. St. Paul
 Graves Wm. J. (*Putnam & Graves*), 95 Powers' buildings, boards 12 Joslyn park
 Graves William J. teamster, b. 296 Monroe avenue [281 Brown
 Grawitz Adam, upholsterer, 9 Front, boards
 Grawitz Mary Mrs. house 281 Brown
 Gray Catharine, deceased November, 1875

HENRY C. WISNER,

WHITE CHINA DINING and TEA SETS,
 No. 33 STATE STREET.

Gray Charles W. grocer, 136 State, house 22
 Arnold park
 Gray Edmund S. deceased July, 1875
 Gray Eliza, seamstress, h. Averill near Cobb
 Gray George H. clerk, 33 E. Main, boards 14
 James
 Gray George K. switchman, n. Ames c. R. R.
 Gray George W. clerk, 2 Mumford, bds. 28
 Pearl
 Gray James C. 143 East Main, h. 72 North av.
 Gray John, laborer, house 1 Huntington
 Gray John G. pattern maker, 108 State, h. 14
 James
 Gray John W. b. 15 Edinburgh [Charlotte
 Gray Joseph P. tinsmith, 153 E. Main, h. 25
 Gray Joseph S. farmer, h. Ames n. railroad
 Gray Margaret, seamstress, b. Averill n. Cobb
 Gray Samuel J. blacksmith, 5 Spring, boards
 49 Joiner
 Gray Thomas, agent, boards Stone near Court
 Gray William, blacksmith, Mill c. Factory,
 h. 49 Joiner
 Gray Wm. jr. blacksmith, 14 Market, h. 3
 Prospect
 Gray William C. civil engineer, b. 28 Pearl
 Gray Wm. R. cutter, 72 Mill, house 28 Pearl
 Greasley James, saloon, 41 E. Main, h. do.
 Greb Michael, wheelwright, 245 E. Main, h.
 North avenue n. Channing [n. Orchard
 Greek Felix, baker, 45 Fitzhugh, h. Wilder
 Greely Hiram M. boards 6 Trowbridge
 Greely Lillis, widow, house 6 Trowbridge
 Green Abner, house 22 Arnold park
 Green Ann, widow, h. 86 University avenue
 Green Catharine, widow, house 644 West av.
 Green Charles, gunsmith, 3 West Main, h.
 11 Trowbridge
 Green Charles A. house 22 Arnold park
 Green Charles J. policeman, City Hall, house
 16 Dean
 Green Charles S. tinsmith, boards 16 Dean
 Green Charles W. grocer, 49 Monroe avenue,
 house do. [bds. do.
 Green Chas. W. jr. clerk, 49 Monroe avenue,
 Green Chauncey H. foreman, Brown corner
 Jones, house 17 Bolivar [sity av.
 Green C. W. brakeman, h. Crouch n. Univer-
 Green DeWitt C. engineer, h. 35 Litchfield
 Green Eli, boards 38 Clifton
 Green Eliza, bds. East avenue c. Alexander
 Green Gertrude, widow, house 93 Chatham
 Green James, carpenter, house 60 Alexander
 Green James, removed from city
 Green James H. clerk, 45 Powers' bldgs. b.
 18 Mortimer
 Green John, contractor, house 89 N. Union
 Green Luther, removed from city
 Green Maria, widow, house 18 Mortimer
 Green Monroe A. fish propagator, house 85
 Broadway [51 Park av.
 Green Mortimer H. bookkeeper, 82 State, h.
 Green Philip, grocer, East Main near Uni-
 versity avenue, h. 84 University av.
 Green Richard, whipmaker, Allen c. North
 Washington, boards 24 Centre
 Green Robert, carpenter, house Scrantom
 near Conkey avenue [mer
 Green Seth, fish commissioner, h. 16 Morti-

Green Thomas, gardener, house 55 Caroline
 Green Thomas, nurseryman, b. 60 Alexander
 Green Westroppe H. painter, h. 46 Sherman
 Green William, engine wiper, b. 17 Bolivar
 Green Wm. A. hairdresser, house 46 S. Ford
 Green Wm. E. painter, house 45 Orange
 Greene Florence E. Mrs. teacher, boards 18
 Champion [93 North av.
 Greene Frank L. shoetreeer, 81 N. Water, h.
 Greene Frederick J. foreman, 3 Canal, bds.
 80 West avenue
 Greene George W. grocer, 37 Lyell house do.
 Greene James, nurseryman, house 75 Hunter
 Greene James G. sewing machine repairer,
 43 State, house 12 North Frances
 Greene Mary A. boards 27 Kent
 Greene Rachel, domestic, 79 Lake avenue
 Greene Walter D. physician, City Hospital,
 boards do. [near toll gate
 Greenfield George, gardener, house Lake av.
 Greenhagen Frederick, laborer, h. 19 German
 Greenhalgh Theophilus, music teacher, house
 108 Tremont [b. 20 North av.
 Greenleaf Chas. B. lockmaker, Court c. Stone,
 Greenleaf Eliza M. boards Goodman n. Uni-
 versity avenue
 Greenleaf Halbert S. (*Sargent & Greenleaf*),
 Court cor. Stone, house Goodman near
 University avenue
 Greenleaf Malcomb C. agent, b. 49 Asylum
 GREENNAGEL MICHAEL, livery stable,
 6 Lancaster, house 2 James.—See p. 602
 Greenslade William C. driver, 63 Exchange,
 house 28 Sanford [Stillson
 Greenstone Julius, clerk, 40 State, b. 5 North
 Greenstone Michael M. cigarmaker, 33 Mon-
 roe avenue, boards 5 North Stillson
 Greenstone Morris, salesman, h. 5 N. Stillson
 Greenstone Myer, peddler, house 27 Joiner
 Greentree Myer (*Caring, Weicher & Co.*), 87
 North Water, house 26 Andrews
 Greenwood George, shoemaker, 73 N. Water,
 boards 80 Mumford [c. Orange
 Greenwood John W. student, boards Grape
 GREENWOOD JOHN & CO. (*S. Teal*),
 Rochester Barrel Machine Works, Green-
 wood's building, Mill n. Furnace, house
 Grape corner Orange.—See page 688
 Greenwood Robert, machinist, 124 Mill, h.
 40½ Grape [21 Grape
 Greenwood Thomas, machinist, 124 Mill, h.
 Gregg Gulielma Mrs. house 20 Vick park
 Gregg Henry L. telegrapher, N. Y. C. R. R.
 151 State, house 7 East avenue
 Gregg James N. edge tool maker, foot of
 falls, boards 6 Jones avenue
 Gregg Julia W. teacher, Monroe School, No.
 15, boards 20 Vick park
 GREGG MAHLON, edge tool manufactur-
 er, foot of falls, house 6 Jones avenue.—
 See page 676
 Gregg M. Claude, trimmer, 2 West Main,
 boards 6 Jones avenue
 Gregg Sherman, photographer, 78 State, b.
 28 Alexander
 Gregg William T. house 48 Jones
 Gregory Alice Mrs. house 35 Edinburgh
 Gregory Elijah B. printer, boards 16 Tyler

- Gregory Fanny B. teacher, Atwater School, No. 10, boards 35 Edinburgh
- Gregory Isaac M. associate editor, Democrat and Chronicle, 3 W. Main, h. 11 Pearl
- Gregory James H. Mrs. house 134 Alexander
- Gregory John, removed to England
- Gregory Richard, deceased May, 1876
- Gregory Walter P. removed to Newark, N. J.
- Gregory Wm. R. machinist, b. 35 Edinburgh
- Greig Benjamin, tailor, 66 Smith's bl. h. do.
- Greim Barbara, widow, bds. 37 North av.
- Grell Johanna, widow, house Mauder park
- Grenan Zenobia, artist, boards 27 Charlotte
- Grentzinger Elizabeth, widow, h. 57 Allen
- Grentzinger Peter R. chairmaker, house 69 Orchard [Joseph
- Gresens August, laborer, h. Hoeltzer near St.
- Gresens Charles, laborer, house Hoeltzer n. St. Joseph
- Gress Francis X. laborer, h. Goodman n. Bay
- Gress Frank, laborer, b. Goodman near Bay
- Greve Frederick, dry goods, 107 Caledonia avenue, house do.
- Greve Henry, shoemaker, 68 Herman, h. do.
- Gribbon John D. removed to N. Y. city
- Gribbon Michael, waiter, Congress Hall, b. 24 Galusha
- Gribrbroek Albert, flour, &c. 72 Hudson, h. do
- Gribrbroek Garret H. carpenter, house 2 Vose
- Gribrbroek Henry, carpenter, Minerva alley
- Gridley Julia A. Miss, boards 158 West av.
- Griebel Ferdinand, policeman, City Hall, h. 49 Romeyn [etta avenue
- Griep Henry, teacher, h. Allmeroth c. Henri-
- Griep Henry B. hostler, 47 S. St. Paul, h. do.
- Griep Wm. O. laborer, house 103 Kelly
- Grieve Elizabeth, dressmaker, h. 36 Charlotte
- Griffen Anna F. widow, boards 33 South
- Griffen Arthur B. student, University of Rochester, boards 47 North avenue
- Griffen Edward H. C., Custom House, house 64 Mt. Hope avenue [av.
- Griffen John, switchman, bds. 149 Anderson
- Griffin C. S. Wilbur Mrs. hair work, 56 State, house 4 Elm
- Griffin Edward, shoemaker, 9 Spring, house Chili road near city line
- Griffin Edwin, broker, 53 Powers' bldgs. h. 5 Chili road near York
- Griffin George, h. Chili road n. West avenue
- Griffin George, waiter, boards Chili road n. West avenue
- Griffin Henry, billiards, 17 South St. Paul, house 33 Howell
- Griffin Honora, widow, house 30 Munger
- Griffin James, shoemaker, 9 Spring, h. do.
- Griffin John (*Griffin & Reichert*), house 41½ Munger [74 Clifton
- Griffin John, shoemaker, 75 N. Water, house
- Griffin John P. polisher, 136 Mill, house 341 State
- Griffin Lewis V. clerk, 14 State, h. 4 Elm
- Griffin Margaret, widow, h. 154 N. Clinton
- Griffin Michael, marble polisher, 122 South St. Paul, h. 5½ Munger
- Griffin Patrick, laborer, boards 66 Front
- Griffin Patrick H. butcher, h. West Maple near city line
- Griffin Perry O. salesman, Allen cor. North Washington, boards 61 Lake avenue
- Griffin Weltha Miss, b. Chili road n. West avenue
- Griffin Wm. blacksmith, h. 9 Johnston's blk.
- Griffin William H. agent, boards 18 Favor
- Griffin & Reichert (*J. Griffin and V. Reichert*), hairdressers, 1 South St. Paul
- Griffing Charles F. chairmaker, b. Perkins
- Griffing Charles L. pulpmaker, paper mills, b. Perkins c. Hastings
- Griffing James K. millwright, h. Perkins cor. Hastings
- Griffing Mary A. widow, house Perkins cor. Hastings [Lorimer
- Griffing William D. papermaker, house 2
- Griffis King H. clerk, 44 State, b. 35 North
- Griffith Alfred G. clerk, 151 W. Main, bds. 21 Prospect [venue
- Griffith Charles B. clerk, boards 44 Caledonia
- Griffith David B. chairmaker, h. 46 Bolivar
- Griffith David H. house 44 Caledonia avenue
- Griffith Henry E. salesman, 151 West Main, boards 21 Prospect
- Griffith Henry E. jr. agent, bds. 21 Prospect
- Griffith Edward F. boards 21 Prospect
- Griffith James C. boards 21 Prospect
- Griffith Mary, widow, house 8 Pinnacle av.
- Griffith Thomas R. stenographer, 133 Powers' bldgs. b. 31 North avenue
- Griffith William H. bill poster, house rear 46 South avenue [L. I.
- Griffiths Ebenezer, removed to Brooklyn,
- Grim Bernard, mason, house 54 Oakman
- Grimble Ebenezer, blacksmith, 170 E. Main, house 91 Tappan
- Grimes John, laborer, house 31 Walnut
- Grimes Mary Mrs. boards 270 Plymouth av.
- Grimes Patrick, laborer, boards 31 Walnut
- Griswold Clarence A. rem'd to Chicago, Ill.
- Griswold Edgar D. deceased, May 1875
- Griswold Frederick A. salesman, 8 W. Main, boards 61 Andrews
- Griswold Florence J. Miss, boards 64 Sophia
- Griswold Jarvis, house 147 Jones
- Griswold Lodema, widow, house 64 Sophia
- Griswold Otho, clerk, 114 State, b. 64 Sophia
- Griswold Thaddeus M. whipmaker, Allen n. N. Washington, house 14 Lyell
- Griswold Wm. G. removed from city
- Grivet Eugene, bartender, 29 Front, b. 150 S. St. Paul
- Grivet Jerome, boarding house, 150 South St. Paul, house do.
- Groat Frank A. laborer, boards 19 Cameron
- Groat Wm. S. blacksmith, house 19 Cameron
- Grobenski Cohen, peddler, house 1 Granger
- Groce Freeman, painter, 12 Stone, house 256 State
- Groff Frederick, laborer, boards 38 Tyler
- Groff Mary, widow, house 38 Tyler
- Groh Albert J. foreman, 145 North Water, boards 19 Munger
- Groh Caroline, married to Jos. J. Emmerich
- Groh Catherine, vestmaker, bds. 150 North Clinton
- Groh Catherine, boards 184 North Clinton
- Groh Charles, compositor, boards 19 Munger

HENRY C. WISNER,

CUT AND PRESSED GLASS TABLE WARE,
No. 33 STATE STREET.

Groh George P. shoecutter, 15 Mill, bds. 150
North Clinton [house 14 Franklin
Groh John, boots and shoes, 18 S. St. Paul,
Groh John 2d, shoemaker, 124 Front, house
82 Kelly
Groh John N. mason, house 19 Munger
Groh John S. clerk, 85 E. Main, boards 49
Savannah [Savannah
Groh Joseph, clerk, 18 S. St. Paul, boards 49
Groh Joseph A. removed from city
Groh Mary, widow, house 98 North St. Paul
Groh Nicholas, shoecutter, h. 150 N. Clinton
Groh Philomen, tailor, bds. 150 N. Clinton
Groh Roman, machinist, boards 14 Franklin
Grolling Bernard, cooper, Magne opp. Wal-
nut, boards 95 Whitney
Grolling Johanna, widow, house 95 Whitney
Grolling William, tailor, boards 95 Whitney
Gromer Charles J. shoemaker, 124 Front, b.
99 Champlain
Gromer Magdalena, widow, bds. 12 Bartlett
Groot James, shoemaker, b. 50 Caledonia av.
Groot William H. boards 50 Caledonia av.
Gropp Andrew, laborer, h. Seager n. Lewis
Gropp William, machinist, b. Seager near
Lewis
Grosbusch John, deceased, Sept. 14, 1875
Grosbusch Louisa, widow, h. 112 Campbell
Grosser Geo. shoemaker, 75 North Water, h.
8 New York [boards 23 Brown
Groskens Melanie, bookkeeper, Mill c. Platt,
Grosshans Jacob, stock breeder, house St.
Joseph near Hayward park
Grossmann Adolph, confectioner, 109 North
Clinton, boards do.
Grossmann Max, confectioner, boards 109
North Clinton [Clinton, house do.
Grossmann Theresa, confectionery, 109 N.
Grossmann William, cabinet maker, h. 109
North Clinton
Grossman see Grassman
GROSVENOR OLIVER D. supt. Ameri-
can Tract Society, and bookseller, 75
State, h. 8 Clinton place.—See page 519
Grosvenor Oliver G. student, Univ. of Roch-
ester, boards 8 Clinton place
Grosz Albert M. removed to Illinois [h. do.
Grosz Louis, shoemaker, 254 N. Clinton,
Gross Martin J. clerk, 114 East Main
Groth Louis, boot crimper, 76 North Water,
house 19 Mt. Hope avenue
Grotrian August, pastor, Evangelical St.
Paul's church, house 8 Pitt
Groat Margaret, boards 153 East Main
Groutage Ellen T. Mrs. dressmaker, 6 Scio,
boards do. [Scio
Groutage George E. agent, 45 E. Main, h. 6
Grover Amelia, seamstress, b. Straub al. cor.
McCracken
Grover Charles H. shoemaker, h. 54 Martin
Grover Elihu H. house 75 Sibley's block
Grover Frank, sawyer, house Straub alley c.
McCracken [Main, h. 33 South Ford
Grover Leavitt B. boots and shoes, 114 West
Grover Lucius, baggageman, house 37 Davis
Grover Priscilla Mrs. widow, boards 48 Jay
Groves George W. clerk, boards 46 Smith
Groves John B. machinist, h. 7 Kent alley

Groves Thomas B. wagonmaker, 8 Centre, h.
46 Smith
Groves Thomas H. agent, boards 46 Smith
Grow Joseph, painter, h. r. 131 Lake avenue
Grube Adeline L. widow, boards 41 Platt
Gruber Anthony, shoemaker, 75 West av.
house 89 Campbell
Gruber Catharine Mrs. boards 31 Vose
Gruber Leopold, tobacconist, 77 N. Clinton,
house do.
Gruber Michael, shoemaker, h. 109 Campbell
Gruber Michael jr. shoemaker, boards 109
Campbell
Gruber Peter, painter, house 42 Hoeltzer
Gruber William, removed to New York city
Grue Louis, shoemaker, h. 19 Mt. Hope av.
Gruenemey Ernest, tailor, 114 State, house
81 Morgan
Grugel Charles, mason, house 15 Hoeltzer
Grugel Joseph, laborer, house 16 Hoeltzer
Grumme Lottie, milliner, 77 North av. b. do.
Grunauer John, cabinetmaker, h. 98 Orange
Grunauer Joseph, shoemaker, house 139 Jay
Grunauer Joseph jr. removed to Oil City, Pa.
Grundman John, laborer, house 4 Wadsworth
Gruno Henry, laborer, house 29 Vose
Grunst Henry, laborer, h. 24 McDonald av.
Gruppe Aberthiene, widow, h. 66 Gregory
Gruppe Chas. P. clerk, 85 E. Main, boards
66 Gregory [Gregory
Gruppe Herman F. cigarmaker, boards 66
Guck J. Caspar, carpenter, house 15 Delevan
Guck Lawrence, painter, boards 15 Delevan
GUCKER CONRAD & G. tobacconists,
G Mill c. Factory, h. 88 Frank.—See page
565 [cor. Jay
Gucker George (C. & G. Gucker), h. Frank
Gucker Ludwig, cabinetmaker, 107 State, h.
35 Sanford [house 226 State
Gucker Martin, salesman, Mill cor. Factory,
Guebelle Emilie, teacher languages, 24 East
avenue, house do. [h. 5 Weeger
Guenther Benjamin, trimmer, 87 Exchange,
Guenther Fred. butcher, bds. 116 N. Water
Guenther George, agent, house Weeger near
Hudson [ical Seminary, b. 5 Weeger
Guenther George A. student, Roch. Theolog.
Guenther John F. gardener, East av. n. Cul-
ver, house Bates near Culver
Guenther Michael, laborer, house 49 Tyler
Guenther Samuel, frame maker, b. 5 Weeger
Guenther, see Ginter
Gueret Anthony, winemaker, h. 20 Ontario
Guerinot Bernard, shoemaker, bds. 233 Jay
Guerinot Jacob, shoemaker, 322 State, h. 82
Orange [bds. Childs c. Kondolf
Guerniot Jacob 2d. chairmaker, lower falls,
Guerinot John, chairmaker, lower falls, bds.
51 Childs [N. Water, h. 51 Childs
Guerinot Nicholas, shoemaker, Andrews c.
Guerinot Peter, shoemaker, 121 Jay, house
235 do.
Guerinot Peter jr. carpenter, bds. 235 Jay
Guernsey Electa, widow, house 64 N. Union
Guernsey Frederick W. student, University
of Rochester, boards 11 Oregon
Gugel Barbara, widow, house 99 Cady
Gugelman Frederick, driver, house 13 Bond

Gugelman Jacob, hostler, 104 East av. house
 Goodman near Monroe avenue
 Gugelman John, mason, house Goodman n.
 Monroe avenue [Kelly, h. 17 Vienna
 Gugelman John U. jr. carpenter, Joiner near
 Guggenheim Isaac, clerk, 15 Exchange, bds.
 33½ Monroe avenue [house do.
 Guggenheim Julia, dry goods, 33½ Monroe av.
 Guggenheim William, insurance agent, house
 33½ Monroe av. [Main, h. 6 Clinton pl.
 Guggenheimer Simon, hats, caps, &c. 5 East
 Guhman Josephine, widow, h. 9 Leopold
 Guild Josiah, shoemaker, 133 W. Main, h. do.
 Guile Fannie, widow, h. Swinerton n. Jen-
 nings [37 Madison
 Guile Henry D. engineer, N. Y. C. R. R. bds.
 Guile Hiram, laborer, house Swinerton near
 Jennings
 Guile Jeremiah K. house 37 Madison
 Guinan Bernard M. salesman, 53 East Main,
 boards 146½ West Main [32 Joiner
 Guldenschub Isaac P. engineer, 93 State, h.
 Gullen Thomas, laborer, h. 8 Anderson av.
 Gumm Valentine, cigarmaker, b. 12 Herman
 Gummer Frank L. clerk, 39 Powers' bldgs.
 b. 129 Mt. Hope av. [avenue
 Gummer Susan A. widow, h. 129 Mt. Hope
 Gummo Margaret, widow, boards 12 Herman
 Gummo Peter, mason, house 12 Herman
 Gummo Valentine, cigarmaker, 33 Monroe
 avenue, boards 12 Herman
 Gumprecht Adam, carpet weaver, 56 Orange,
 house do. [123 Jay
 Gundel George, shoemaker, 124 Front, house
 Gundel John, tailor, h. 123 Jay [h. do.
 Gundelshemer Caroline, saloon, 7 North av.
 Gundlach Edward F. clerk, 330 State, b. 28
 N. Frances [Sheridan park
 Gundlach Ernst, optician, house Almira cor.
 Gundlach Henry, laborer, h. 1 Wadsworth
 Gundlach Jacob, carpenter, bds. 18 Leopold
 Gundlach Michael, carpenter, 21 Minerva al.
 house 18 Leopold
 Gundlach Theodore, laborer, b. 1 Wadsworth
 Gundlack Mary M. widow, h. 28 N. Frances
 Gunkler Frederick, flour packer, Irving mills,
 house 38 Hanover
 Gunkler George, teamster, h. Webster road
 near Goodman [nacle avenue
 Gunkler George M. salesman, house 115 Pin-
 Gunn George D. cigarmaker, h. 20 Clifford
 Gunn Stephen J. cigarmaker, Mill cor. Fac-
 tory, h. 17 Clifford [Brighton
 Gunnell Joseph, gardener, h. Pinnacle av. n.
 Gunning John, clerk, house 11 Hill
 Gurnett Charles M. compositor, 3 W. Main,
 house 12 Joslyn park bds. do.
 Gurry Edward W. coachman, 57 East avenue,
 Gursley Mary Mrs. boards 92 Hudson
 Gury Mary domestic, 45 Lake avenue
 Guse August C. shoemaker, 54 Chatham, h.
 68 do. [Chatham
 Gutacker Frederick A. machinist, house 73
 Gutacker Margaret, widow, h. 73 Chatham
 Gutberlet Andrew, carpenter, house 171 Pin-
 nacle avenue
 Gutberlet Nicholas, harnessmaker, South St.
 Paul cor. Ely, house 132 Pinnacle av.

Gute John, yardman, 77 Mill, boards do.
 Gutfreund Emil C. hairdresser, 43 S. St. Paul,
 boards 150 do.
 Gutfried Felix, machinist, b. 150 S. St. Paul
 Guth Andrew J. cigarmaker, 138 West Main,
 boards 156 North Clinton
 Guth Catharine, clerk, boards 156 N. Clinton
 Guth Joseph, bootmaker, 251 N. Clinton, h. do.
 Guth Mary Miss, boards 156 North Clinton
 Guth Mary A. widow, house 156 N. Clinton
 Gutheil George, teamster, house Ulm n. Bay
 Gutheil John, laborer, house Ulm near Bay
 Gutheil John jr. deceased, June 29, 1875
 Guthrie Michael, laborer, house 32 Kent
 Guthrie Patrick, laborer, Brown cor. Jones,
 house 155 Jones
 Gutland Charles F. removed to Syracuse
 Gutmann Max L. watches, 38 William, h. do.
 Gutschel Norah, bds. East av. c. Alexander
 Guttmann Lawrence, tailor, house 8 Hope
 Guttmann Joseph F. tailor, boards 8 Hope
 Guttnacht Anton, shoemaker, 117 E. Main,
 house 111 West Maple
 Guy Maggie, removed from city
 Guyer John, cabinetmaker, house 45 Meigs
 Gwynne Charles F. engineer, Erie railway
 Gwynne Mary I. fancy goods, Frank corner
 Jones avenue, house do.
 Gyatt William, car driver, h. 23 Vincent pl.
 Gysel August A. furniture finisher, bds. rear
 North Clinton near Norton
 Gysel John K. carpenter, boards rear North
 Clinton near Norton
 Gysel Marcellus, carpenter, house rear North
 Clinton near Norton

HAAG ANNA, widow, house 142 N. Clinton
 Haag Bernhard, market, 232 E. Main, house
 29 Scio
 Haag Catharine, widow, h. 23 McDonald av.
 Haag Ephraim, tailor, house 55 Nassau
 Haag Ferdinand, shoemaker, b. 23 McDonald
 avenue [Pomeroy
 Haag Frank, laborer, house West Maple cor.
 Haag George C. clerk, 232 E. Main, b. 29 Scio
 Haag Jacob, driver, 66 Mill, house at Gates
 Haag Jacob, moulder, 8 Hill, house 238 Jay
 Haag John, teamster, house 160 Jay
 Haag John B. clerk, 152 North av. bds. do.
 Haag Louis, tailor, Orange c. Walnut, b. do.
 Haag Louis, shoemaker, 51 East Main, house
 51 Smith
 Haag Louis F. filecutter, boards 51 Smith
 Haag Nicholas, tailor, Orange cor. Walnut,
 house do. [West Maple
 Haag Peter, cigarmaker, bds. North York c.
 Haag Peter, farmer, h. Jay n. Wackerman
 Haag Peter A. door finisher, 13 Warehouse,
 house at Gates [nolia
 Haak Andrew, laborer, h. Frances near Mag-
 Haak Leopold, music teacher, 82 State, h. do.
 Haap John G. clerk, 78 East Main, house 2
 Brighton avenue [Cole
 Haas Alfred J. shoecutter, 22 Front, bds. 3
 Haas Caspar, gardener, house 2 German alley
 Haas G. Warner, tinsmith, 90 E. Main, house
 11 East park [Cole
 Haas John, boots and shoes, 22 Front, h. 3

- Haas John B. sexton St. Joseph's church, 24 Franklin, boards do.
- Haas Josephine, tailorress, bds. 57 North av.
- Haas Frederick, laborer, h. Lewis n. Meigs
- Haas Michael, house 202 Scio
- HAASS G. HERMAN**, druggist, 38 East Main, house 107 North St. Paul.—*See back cover*
- Habel Lawrence, house 41 Sanford
- Haberbosch Frank, shoemaker, 207 North, house do.
- Habich Augustus C. removed to Chicago
- Hacht Charles, laborer, house Pennsylvania avenue near Third avenue
- Hack Ferdinand, laborer, house 14 Almira
- Hack John A. house 41 Gibbs
- Hack Smith, sawfiler, 129 S. St. Paul, h. do.
- Hackett Alfred J. teamster, b. 82 Broadway
- Hackett Bridget, widow, boards 51 Davis
- Hackett Catharine F. seamstress, bds. Brown corner Frank [h. 106 Champlain
- Hackett Edward, carpenter, 148 Plymouth av.
- Hackett Horatio B. deceased Nov. 1875
- Hackett Hugh, book peddler, house Brown corner Frank
- Hackett John, deceased Feb. 2, 1876
- Hackett John L. machinist, 1 River, house 132 North avenue [avenue
- Hackett J. R. harness maker, bds. 13½ East
- Hackett Mary, widow, house 19 Smith
- Hackett Michael, gardener, boards Brown corner Frank [plain
- Hackett Patrick H. carpenter, bds. 106 Cham-
- Hackstaff Fred. D. printer, 23 Elwood block, boards 10 Alexander
- Hackstaff Nathan T. job printer, 23 Elwood block, house 10 Alexander
- Haddel Anthony, laborer, house 39 W. Maple
- HADDLETON JOSEPH**, wire goods manufacturer, 89 State, h. 12 George's park.—*See page 609*
- Hadley Nicholas, baking powder manuf. 22 S. St. Paul, house Seward n. Magnolia
- Hadley Willis C. clerk, 125 State, house 32 Atwater
- Haeffle Anna Miss, bds. 107 North St. Paul
- Haeffner Frank, saloon, Exchange c. Clarissa, house do. [145 Jay
- Haeffner Joseph, upholsterer, 6 Front, boards
- Haeffner Louis, cabinetmaker, house 145 Jay
- Haeffner Martin, mason, house 126 South av.
- Haege John, stonecutter, h. 139 Campbell
- Hafele Michael, shoemaker, 75 West avenue, house Frances corner Frost avenue
- Hafele Odelia, widow, house 55 Cypress
- Hafey John, teamster, boards 7 Otsego
- Haff John, teamster, boards 332 State
- Haff Mary, domestic, 36 Lyell
- Haffarn Catharine, widow, house 17 Delevan
- Hafner Adam, laborer, b. Magnolia n. Frances
- Hafner Amon, tailor, house 23 Catharine
- Hafner Anthony, carpenter, house 7 Oakman
- Hafner Erhard, sawyer, house 103 Saxton
- Hafner Jacob, laborer, house Fourth avenue near Pennsylvania avenue [Crouch
- Hafner Jacob, watchman, h. University av. c.
- Hafner John, laborer, house 2 North York
- Hafner John, laborer, h. Magnolia n. Frances
- Hafner Joseph, shoemaker, 79 N. Water, h. 5 Elizabeth place
- Hafner Mary, trimmer, boards 103 Saxton
- Hag Frank, laborer, Brown c. Wentworth
- Hagaman Howland S. removed to Batavia
- Hagaman S. Wallace, bookkeeper, 175 South St. Paul, boards 68 do.
- Hagan Charles, laborer, house 14 Almira
- Hagan John, laborer, house 30 Brown's alley
- Hagan Rosa, dressmaker, 318 State, h. do.
- Hagart James R. collarmaker, 77 State, bds. 13½ East avenue [45 Orange
- Hagarty Peter J. scroll sawyer, Aqueduct, b.
- Hagele Gottfried, mason, house 54 Whitney
- Hagele John, saloon, 5½ Wilder, house do.
- Hagen Arthur T. (*Hagen & Myers*), boards 15 Pleasant [Stone, b. 13 Pleasant
- Hagen Benjamin, watchmaker, Court corner
- Hagen James, laborer, European Hotel, b. do.
- Hagen Oliver, watchmaker, 35 Powers' bldgs. house 13 Anson park
- Hagen Patrick, moulder, 20 Court, h. 24 do.
- Hagen & Myers (*A. T. Hager and Peter Myers*), laundry, 4 N. Clinton
- Hager Charles, laborer, house Elm near Bay
- Hager Fannie, tailorress, boards 95 Lyell
- Hager John, stonecutter, 8 West avenue
- Hager Joseph, engineer, 16 Exchange, h. 90 Childs
- Hager Wm. A. carpenter, boards 90 Childs
- Hagerty Alice, widow, house 38 Griffith
- Hagerty James, removed to Jamestown, Iowa.
- Hagerty James B. carpenter, bds. 38 Griffith
- Haggerty Ellen Mrs. house 15 Vincent place
- Haggerty Joseph, groom, 113 Mill, boards 15 Vincent place
- Haggerty Marmaduke, confectioner, 39 Exchange, b. 141 Hunter
- Haggerty Matthias, cigarmaker, b. Tremont corner Reynolds
- Haggerty Patrick, mason, house 59 Hickory
- Haggerty Wm. printer, 8 State, h. 141 Hunter
- Hagle John C. policeman, City Hall, house 67 Lowell [York House
- Hagopian Martin, tailor, 100 State, boards
- Hagreen Charles H. deceased Nov. 2, 1875
- Hagreen Isaac, carpenter, house 3 Delevan
- Hagues Conrad, house 184 Jay
- Hagues Conrad jr. factory hand, b. 184 Jay
- Hahle William H. carriage painter, 109 Pinnacle avenue, house Allmeroth
- HAHLE WM. H.** carriage painter, 109 Pinnacle avenue, house Allmeroth.—*See page 604*
- Hahn Adam, tanner, 87 North Water
- Hahn Charles (*Kalb, Hahn & Co.*), 5 Mumford, house 36 Gorham [n. Diem
- Hahn Constantin, shoemaker, house Lewis
- Hahn Elizabeth, widow, boards 19 Kelly
- Hahn Frank, tailor, house 88 Weld
- Hahn Frank A. deceased May, 1875
- HAHN GEORGE**, railroad truckman, 13 Andrews, and (*Hahn, Weis & Co.*), h. 73 Monroe avenue.—*See page 604*
- Hahn George 2d, clerk 112 East Main, boards 52 South St. Paul
- Hahn George A. foreman, house 28 Hand
- Hahn Gertrude, widow, house 5 Marshall

- Hahn Henry, laborer, 3 Elizabeth, house 271 St. Joseph [5 Marshall
Hahn John, butcher, 56 South St. Paul, bds.
Hahn John jr. market, 56 S. St. Paul, h. do.
Hahn John, blacksmith, house 79 S. Union
Hahn John, boards 52 South St. Paul
Hahn John B. flour, &c. and (*Hahn, Weis & Co.*), 52 S. St. Paul, house do.
Hahn Joseph C. (*Hahn & Dunn*), harness makers, 179 E. Main, b. 79 South Union
Hahn Louis, deceased 1875 [79 S. Union
Hahn Nicholas, butcher, 136 E. Main, bds.
HAHN, WEIS & CO. (*J. B. Hahn, John Weis, George Hahn and Rudolph Weis*), brick manufacturers, 52 South St. Paul. —See page 638 [Joseph
Hahn William, shoemaker, 15 Mill, h. 263 St.
Hahn & Dunn (*Joseph C. Hahn and Patrick Dunn*), harnessmakers, 179 East Main
Hahnke Julius, brewer, 111 N. St. Paul, h. 25 Pryor
Haiges Frederick, removed to Buffalo [av.
Haight Catharine T. widow, h. 95 Plymouth
Haight Eliza M. Miss, teacher, boards 95 Plymouth avenue
Haight Hilten R. boards 95 Plymouth avenue
Haight Isaac, hairdresser, 214 West Main, h. 30 Elizabeth [bds. 10 Edinburgh
Haight James H. hairdresser, 22 Exchange,
Haight Joseph A. cook, House of Refuge, boards do. [bds. 10 Edinburgh
Haight J. William, hairdresser, 22 Exchange,
Haight Wm. hairdresser, 22 Exchange, h. 10 Edinburgh [Smith's block
Haight Wm. cutter, 8 W. Main, house 49½
Haines Edward, potter, 31 Weld, boards do.
Haines John E. painter, house 16 Nassau
Haines Julia E. dressmaker, 18 Allen, h. do.
Hainas Sarah E. cook, 7 South St. Paul
Hainstar Andrew, marble polisher, 122 S. St. Paul, house Childs near Lime
Hair Florence Miss, boards 101 West avenue
Hair Jennie, dressmaker, 10 Oregon, h. do.
Hair Luther M. student, University of Rochester, boards 85 Court [do.
Hair Mattie Miss, dressmaker, 10 Oregon, h.
Haisman John, machinist, 141 N. Water, b. 3 Tappan [80 Cady
Haitz Valentine, stonecutter, 22 West avenue,
Haitz William, stonecutter, 22 West avenue, house 48 Frances [near Bay
Haker Fritz, cabinetmaker, boards First av.
Haker Rudolph, machinist, Brown c. Jones, house 39 Wilder
Haker Wm. laborer, house 26 Wadsworth
Hakes Elihu jr. clerk, 13 E. Main, boards 16 North Clinton
Halbert James, marble polisher, house Mt. Vernon av. n. Caroline
Halbleib Kilian, sawyer, 184 State, h. 292 Jay
Halden Frederick B. packer, 33 State, house 46 Asylum [house do.
Hale Benjamin F. photographer, 75 E. Main,
Hale Charles G. machinist, Brown c. Jones, house 7 Tremont
Hale Elias E. (*Deavenport & Hale*), 163 East Main, house 15 Park avenue [Paul
Hale George D. school, 27 State, b. 66 S. St.
Hale Henry S. engineer, Erie railway, house 49 Troup
Hale John A. boards 59 Andrews
Hale Minnie E. Miss, music teacher, Bortle Seminary, boards 75 East Main [ander
Haley Anna, laundress, b. East av. c. Alex-
Haley Benjamin, boards 61 Hunter
Haley Catharine, cook, Children's Home, 263 N. St. Paul, boards do.
Haley Elizabeth, domestic, b. 101 Lake av.
Haley James, laborer, b. 149 Anderson av.
Haley Jeremiah, laborer, h. 112 Caledonia av.
Haley John, plumber, 48 East Main, boards 168 Alexander [do.
Haley Mary, housekeeper, Congress Hall, b. Haley Michael, tailor, 2 W. Main, b. 19 Smith
Haley Patrick, steward, Whitcomb House, boards do.
Haley, see Healy
Halferty Michael H. clerk, b. Centre c. Mill
Halis John, gardener, h. Bowen n. Monroe av.
Hall Adelbert S. clerk, 281 State, b. 282 do.
Hall Alexander, deceased Aug. 31, 1875
Hall Ambrose, cabinetmaker, h. 30 Magne
Hall Andrew J. house 73 Court
Hall Ann, widow, boards 133 Plymouth av.
Hall Anna, widow, boards 61 Lancaster
Hall August, wood yard, 6 Cobb, house do.
Hall Benajah T. house 271 N. St. Paul
Hall Benjamin T. ass't. rector, St. Paul's church, house 33 S. Union
Hall Caroline, widow, boards 98 East avenue
Hall Catharine, widow, house Tremont near Reynolds
Hall Celia A. Miss, removed to Fairport
Hall Charles, laborer, house 66 Sherman
Hall Charles, laborer, house 152 Jones
Hall Charles S. master mechanic, 10 South Water, h. 41 Lancaster [41 Lancaster
Hall Charles S. jr. salesman, 10 S. Water, b.
Hall Cordilla Mrs. house 13 West Troup
Hall Darius H. polisher, house 37 Martin
Hall Edward C. clerk, 74 State, boards 110 Lake avenue
Hall Edward W. bookkeeper, b. 41 Lancaster
Hall Elizabeth P. Miss, house 41 Frank
Hall Emily, widow, bds. East av. n. Bowen
Hall Emma Miss, boards 133 Plymouth av.
Hall E. Louisa, boards 33 University avenue
Hall Frank D. business manager, Rochester Opera House, boards 11 Pleasant
Hall Franz J. tailor, house 6 Cayuga place
Hall Frederick H. fireman, N. Y. C. R. R. boards 4 Charlotte
HALL GEORGE, carpenter and contractor, Joiner corner Kelly, house 18 Kelly. —See page 640
Hall George A. carpenter, boards 18 Kelly
Hall George F. removed to Syracuse
Hall George W. carpenter, house Exchange corner Greig
Hall Harvey, 20 E. Main, b. Brackett House
Hall Henry, tailor, 73 Sanford, house do.
Hall Henry, blacksmith, 3 Canal, boards 10 Litchfield [Lake avenue
Hall H. Owen, bookkeeper, 74 State, h. 110
Hall Jacob B. (*L. J. Hall & Bro.*), grocer, 98 East avenue, boards do.

Hall James, polisher, boards 37 Martin
 Hall John, stenographer, 62 State, house
 Smith cor. Jones
 Hall John, painter, house 1 Munger
 Hall Jonathan O. harnessmaker, 281 State,
 house 283 do.
 Hall J. Clinton, lessee and manager, Roch-
 ester Opera House, house 11 Pleasant
 Hall Leo. J. & Bro. (*Jacob B. Hall*), grocers,
 98 East avenue, house do.
 Hall Maria, domestic, Whitney place
 Hall Martin V. engineer, house 337 Brown
 Hall Mary, widow, house 136 State
 Hall Mary, widow, house 32½ South Ford
 Hall Mary E. gilder, 38 Gorham, b. Gorham
 near Almira
 Hall Mary J. Miss, house 91 Exchange
 Hall Millie M. teacher, Tremont School, No.
 3, boards 47 South avenue
 Hall Nancy, widow, house 21 West
 Hall Newman, removed to Chicago, Ill.
 Hall Rebecca, widow, house 4 Edinburgh
HALL RICHARD D. & CO. produce,
 fruit, &c. 175 and 177 E. Main, h. 160
 do.—See page 551 [York House
 Hall Robert, tinsmith, 29 Exchange, boards
 Hall Sidney, boilermaker, 138 Mill, house
 116 Champlain
 Hall William B. clerk, house 13 W. Troup
 Hall William H. finisher, 3 Canal, house
 rear 88 Adams
 Hall William H. mason, house 18 Swan
 Hall William R. builder, house 21 Reynolds
 Hall Wm. S. shoemaker, b. 116 Champlain
 Hall William T. boards 73 Court
 Halleck Wm. T. student, b. 58 Monroe av.
 Haller Christian, grocer, 104½ Hudson, h. do.
 Haller Julius, foreman brewer, h. 81 Herman
 Hallet James, deceased 1876
 Hallet Thomas, laborer, house 29 Kirk
 Halliday Lizzie H. tailoress, 20 East Main,
 boards 13 Bloss [alley
 Halifax Henry T. coachman, h. 35½ Brown's
 Hallings Peter, mason, house 159 Hudson
 Halloran Ann, widow, house 111 Whitney
 Halloran Ann, dressmaker, bds. 111 Whitney
 Halloran Catharine, domestic, b. 42 Franklin
 Halloran Charles, removed to Buffalo
 Halloran Cornelius, brakeman, bds. 31 Kent
 Halloran Daniel, brakeman, h. 24 Kent al.
 Halloran Dennis, brakeman, b. 111 Whitney
 Halloran James, carpenter, b. 111 Whitney
 Halloran John, laborer, house 31 Kent alley
 Halloran Michael, laborer, bds. 31 Kent al.
 Halloran Patrick, brakeman, b. 111 Whitney
 Halloran Thomas, teamster, boards 31 Kent
 Halloran, see Holloran
 Hollowell William R. (*Hollowell & Willis*),
 and (*J. E. Spencer & Co.*), house 51 Ply-
 mouth avenue
 Hollowell & Willis (*W. R. Hollowell, I. and*
E. P. Willis and H. H. Pyott), wool, 39
 North Water [35 Gibbs
 Halpin Edward, grocer, 142 East Main, h.
 Halpin Hugh, carriagemaker, h. 61 Munger
 Halpin James H. grocer, 53 North avenue,
 house 12 Grove
 Halsal Wm. car inspector, h. 45 Concord av.

Halsey Abram, cashier, Frost av. cor. Olean,
 house do. [78 West av.
 Halsted Homer, bookkeeper, 35 State, bds.
 Halsted Leonard, teamster, bds. 20 Prospect
 Halsted Samuel H. machinist, Brown c. Jones,
 house 153 Wilder [h. 23 Galusha
 Halzer John, machinist, Mill cor. Factory,
 Ham Charles T. pres't Buffalo Steam Gauge
 and Lantern Works, 13 Warehouse, house
 46 Jones avenue
 Ham Cynthia, widow, house 55 Lancaster
 Ham Edward B. painter, bds. 55 Lancaster
 Hamblet George, foreman, N. Y. C. black-
 smith shop, Brown c. Jones, h. 64 Bolivar
HAMBLETON ANGELINA, druggist, 111
 Plymouth avenue, house do.—See p. 569
 Hamburger Lewis E. removed from city
 Hamer John (*J. E. Hayden & Co.*), 73 State,
 boards 19 Park avenue
 Hamerick Francis A. carpenter, h. 4 Ward
 Hamerick John, mason, house 48 Gregory
 Hamerick Joseph, butcher, 158 State, bds.
 Waverley House
 Hames Cornelius P. carpenter, h. 11 William
 Hamill Ella, dressmaker, bds. 238 Exchange
 Hamill Robert, mail agent, N. Y. C. depot,
 boards 18 Allen
 Hamill Robert O. boards 238 Exchange
 Hamilton Abram, laborer, boards 41 Meigs
 Hamilton Amanda, widow, b. 181 Exchange
 Hamilton Arthur S. (*Hamilton & Mathews*),
 house 29 South Washington
 Hamilton Charles H. tinsmith, b. 3 Spencer
 Hamilton Edward, laborer, Erie R. R. freight
 house, boards 140 Plymouth avenue
 Hamilton Edwin F. bookkeeper, 72 West
 Main, house 14 Briggs' place
 Hamilton Eliza, widow, house 232 State
 Hamilton Elizabeth, widow, h. 11 Edinburgh
 Hamilton Elizabeth Miss, dressmaker, 11
 Edinburgh, boards do.
 Hamilton Elizabeth T. widow, h. 170 Brown
 Hamilton Franc F. physcian, 1 Henion place,
 house do.
 Hamilton George, machinist, h. 34 Spencer
 Hamilton George W. hairdresser, National
 Hotel, house 105 Mill
 Hamilton Henry G. secretary, D. R. Barton
 Tool Co. Mill c. Furnace, house 25 Jay
 Hamilton Hollister, driver, 72 West Main,
 house 2 Frances
 Hamilton Hugh (*Hamilton & O'Connell*), h.
 80 Lake avenue
 Hamilton James, laborer, Brown's race near
 Furnace, house 11 Stepheny's park
 Hamilton Jennie Miss, boards 105 Mill
 Hamilton John, blacksmith, h. 23 Brown's al.
 Hamilton Michael J. F. coremaker, Brown's
 race n. Furnace, bds. 11 Stepheny's park
 Hamilton Myron H. watchmaker, b. 47 Edin-
 burgh
 Hamilton Nancy, widow, house 3 Spencer
 Hamilton Rachel, seamstress, bds. 205 State
 Hamilton Robert, machinist, Brown c. Jones,
 house 18 Bismarc
 Hamilton Samuel, deceased Jan. 26, 1876
 Hamilton Sarah, widow, h. 66 Plymouth av.
 Hamilton Sophia T. boards 232 State

Hamilton Thomas, physician, house 27 South Washington
 Hamilton Wade, laborer, h. 25 S. St. Paul
HAMILTON & MATHEWS (*A. S. Hamilton and Robert Mathews*), hardware, 21 West Main.—*See page 630*
 Hamilton & O'Connell (*H. Hamilton and M. J. O'Connell*), grocers, 194 State
 Hamlin Lovel, hackman, r. 8 Jackson, h. do.
 Hamlin Orrin, laborer, house 85 Julia
 Hamm George, shoemaker, 73 N. Water, h. W. Maple c. Hague [83 Scio
 Hamm George C. bookkeeper, 78 State, bds.
 Hamm John, laborer, 45 Fitzhugh, h. 162 do.
 Hamm John A. plumber, 153 East Main, h. Shamrock n. N. Clinton [232 Brown
 Hamm Leonard, engineer, N. Y. C. R. R. h.
 Hamm Leonard jr. machinist, Brown cor. Jones, boards 41 Oak
 Hamm Sarah, milliner, bds. foot Ambrose
 Hammal Patrick, laborer, h. 37 Fulton av.
 Hamman Frederick, laborer, h. 47 Hoeltzer
HAMMATT EDWARD R. secretary and treasurer Rochester Savings Bank, West Main, corner Fitzhugh, house 89 Lake avenue.—*See page 496* [Kirk
 Hammen Calvin, carriage painter, bds. 24
 Hammen Charlotte, tailoress, house 24 Kirk
 Hammen Christopher, laborer, h. 27 Hoeltzer
 Hammen John, laborer, house 35 Oakman
 Hammen William, teamster, 13 Warehouse, boards 24 Kirk
 Hammer Amelia, laundress, house 3 Swan
 Hammer August, sawyer, 22 West av. house Trowbridge n. Erie canal
 Hammer James V. agent, 178 Plymouth av. house 42 Hunter
HAMMER JOHN M. pottery, 151 West Avenue, house 149 do.—*See page 576*
 Hammerschmidt John, hairdresser, house 67 Chatham
 Hammes Peter, cigarmaker, h. 21 Delevan
 Hammes Peter jr. machinist, b. 21 Delevan
 Hammett Eugene E. house 88 Plymouth av.
 Hammill James H. screwcutter, 123 Mill, b. 9 Bauer
 Hammill John, carpenter, house 9 Bauer
 Hammill John jr. carpenter, boards 9 Bauer
 Hammond Catharine Mrs. nurse, b. 5 Jones
 Hammond Edgar D. hackman, 21 Otsego, house 5 do. [b. 72 Mt. Hope av.
 Hammond Edward, cigarmaker, 6 N. Water,
 Hammond Frank L. carpenter, h. avenue D.
 Hammond James, grocer, 152 W. Main, h. do.
 Hammond John I. clerk, 62 West av. b. do.
 Hammond Lydia, widow, boards 49½ Hamilton place
 Hammond Mary, widow, boards 56 S. Union
 Hammond Robert, painter, h. 37 Reynolds
 Hammond S. B. salesman, 36 Exchange, h. at Batavia
 Hammond Thomas, clerk, 152 W. Main, b. do.
 Hammond Thomas D. foreman, Aqueduct near canal, house 1 Henion place
 Hammond Wm. C. variety store, 104½ West avenue [Alexander
 Hamn David, freight conductor, house 208
 Hamner John, removed to Parma

Hamner Sarah, stitcher, boards 37 Kent
 Hamp Charles, laborer, h. Caroline n. Meigs
 Hamp Henry, laborer, house 8 Bay
 Hamp Louis, shoemaker, boards 8 Bay
 Hamp Sophia, widow, boards 47 Hoeltzer
 Hampton Alexander, florist, 93 State, house 143 Adams
 Hampton John (*Hampton & McCall*), house Lyell near Whitney
 Hampton Wm. H. painter, house 8 Kent al.
 Hampton & McCall (*J. Hampton and J. J. McCall*), market, 348 State
 Hanan Thomas, cutter, 83 N. Water, b. Jones
 Hancock Benjamin F. tinsmith, h. 23 George
 Hancock Charles J. clerk, 117 East Main, b. 35 Atkinson [112 Adams
 Hancock George H. cutter, 32 West Main, b.
 Hancock John, merchant tailor, 32 W. Main, house 35 Atkinson
 Hancock Mary, widow, house 36 Ward
 Hancock Mary A. boards 36 Ward
 Hand Ekins, machinist, 2 E. Main, house 110 Broadway
 Hand Matthew, carpenter, boards 18 Allen
 Hand J. Selby, agent, boards 110 Broadway
 Handel Arthur, boards 48 Wilder
 Handel Caspar Mrs. widow, h. 48 Wilder
 Handel George, tinsmith, h. Goodman n. Bay
 Handel see Hendel
 Handley Daniel, laborer, house 14 Campbell
 Handy Elijah F. market, 150 W. Main, h. 24 South Ford
 Handy John, carpenter, h. Frank n. Lorimer
 Handy Sophronia G. deceased November 13, 1875 [n. Lorimer
 Handy W. Adelbert, butcher, boards Frank
 Hane John, grinder, house 24 Caroline
 Hanevy Lawrence, laborer, h. 37 Goodman
 Hanford Catharine, widow, house Lake av. corner McCracken [McCracken
 Hanford Charles M. engineer, b. Lake av. c. Hanford Emily, teacher, Monroe School, No. 15, boards 89 Alexander
 Hanford Hattie B. teacher, No. 7, boards Lake avenue c. McCracken
 Hanford Henry S. bond and mortgage clerk, Rochester Savings bank, house 4 Meigs
 Hanford H. Clay, machinist, b. 1 Brisbane
 Hanford Lois, teacher, Glenwood School, No. 7, bds. Lake av. c. McCracken
 Hanford W. I. contractor, h. 89 Alexander
 Hanke August F. laborer, h. 111 Chatham
 Hanks Byron M. resident engineer, Erie canal, 153 Powers' bldgs. h. Pearl opp. Union
 Hanks Caleb S. civil engineer, bds. 24 Pearl
 Hanley James, house 28 Campbell
 Hanley Mary A. removed to Albion
 Hanlin John C. tobacconist, 57 State, boards 6 Galusha
 Hanlin Kate, whip maker, boards 8 Jay
 Hanlon Martha S. widow, house 85 Weld
 Hanna Edward, cooper, Butler c. Charles, h. 165 Brown
 Hanna Elizabeth, widow, house 39 Hickory
 Hanna James E. upholsterer, house 15 Meigs
 Hanna James P. blind maker, Aqueduct, b. 39 Hickory

HANNA JANE B. millinery, embroidery, stamping, &c. 44 State, h. 15 Lyell.—*See page 546*
Hanna John, cartman, house 20 Prospect
Hanna John, cooper, 5 Charles, h. 166 Brown
Hanna John A. carpenter, Minerva alley, b. 4 North Union
Hanna Lizzie, milliner, boards 15 Lyell
Hanna Nicholas, cooper, house 4 N. Union
Hanna Nicholas C. carpenter, Minerva alley, boards 4 North Union
Hanna Thomas, cooper, house 102 East av.
Hanna Wm. B. bookkeeper, 80 State, boards 15 Lyell
Hanna Wm. R. carpenter, bds. 39 Hickory
Hannafy John, laborer, h. Sibley opp. Bates
Hannagan Francis R. laborer, b. 32 Munger
Hannagan George, plumber, 117 W. Main, boards 32 Munger
Hannagan Mary, widow, house 32 Munger
Hannah Philip, foreman, 7 N. Water, house 10 Gardiner park [102 East av.
Hannah Thomas, cooper, Butler c. Charles, h.
Hannahs Eliza D. teacher, Riley School, No. 14, boards 52 University avenue
Hannan Bridget, widow, house 177 Exchange
Hannan John, hackman, house 35 South av.
Hannan John W., U. S. gauger, b. 10 James
Hannan Michael, laborer, house 87 S. St. Paul
Hannan Patrick, laborer, house 74 Munger
Hannemann John, laborer, h. 40 Hoeltzer
Hanns John, miller, Frankfort mills
Hanrahan Bridget, widow, boards 16 Morris
Hanrahan Michael, laborer, house 16 Morris
Hanrahan Patrick, laborer, boards 16 Morris
Hanrahan Thos. P. rem'd to Memphis, Tenn.
Hanratty Daniel J. laborer, bds. 67 Tremont
Hanratty Felix, laborer, house 67 Tremont
Hanratty John T. clerk, boards 67 Tremont
Hanratty Peter M. cutter, 77 N. Water, bds. 67 Tremont
Hans George, carpenter, house 90 Smith
Hans John, laborer, house Bay corner Elm
Hans Lawrence, chair maker, 184 State, bds. 90 Smith
Hansel Charles, laborer, house 4 Wait
Hansel Peter, cabinet maker, 3 Canal, house 153 Jay [1 Grape
Hansen Charles J. trimmer, 14 Mumford, b.
Hansen Hannah, widow, house 1 Grape
Hansen John, hostler, house 96 State
Hansen Sophia, widow, boards 48 Thomas
Hansen William J. C. cutter, 24 State, house 72 Walnut
Hansis Adam, foreman, Scio n. Huron, h. Miller near Bay [North
Hansis Charles, teamster, h. Channing near
Hansis Gottlieb, laborer, 144 East Main, h. 6 Bay
Hanson Angeline, widow, house 206 Jay
Hanson John, removed to Canada
Hanson Mary A. tailoress, boards 26 Holland
Hanson Robert, hairdresser, 13 Exchange, h. 66 Asylum
Hanss Valentine, hairdresser, 159 E. Main, house 23 Delevan
Hanvey Dell S. teacher, Concord School, No. 18, boards 19½ Kent

Hanvey Fannie J. teacher, No. 18, boards 19½ Kent
Hanvey James, conductor, house 158 Brown
Hanvey James B. boards 19½ Kent
Hanvey Maggie, milliner, b. Saxton c. Lime
Hanvey Martha J. widow, h. Saxton c. Lime
Hanvey Mary J. Miss, milliner, Saxton cor. Lime, h. do. [apolis, Ind.
Hanvey Nellie A. Miss, removed to Indian-
Hanvey Robert J. boards Saxton c. Lime
Hanvey Thomas, house 19½ Kent
Hapgood Charles G. lawyer, 84 Powers' bldgs. boards 3 South
Happeler John, brewer, h. 218 N. St. Paul
Hardenbrook James E. salesman, 80 State, h. 6 Upton pk.
Harder John N. coroner, 59 State, house 84 West avenue
Harder William, carpenter, house 39 Vienna
Harder see Harter [245 State
Harding John, shoemaker, 87 East Main, h.
Hardman Fred. brewer, Cottage n. Plymouth avenue, boards do. [27 do.
Hardy Charles W. accountant, 103 State, h.
Hardy James B. clerk, house 67 Alexander
Hardy J. bookkeeper, h. 10 Greenwood av.
Hardy Lucy, widow, boards 67 Alexander
Hardy Susan, widow, house 59 Tyler
Hare John, clerk, 222 E. Main, b. 29 Gibbs
Hargarter Charles, tinsmith, boards 41 Grape
Hargarter Elizabeth, widow, house Tremont corner Reynolds
Hargarter John, carpenter, house 45 Orange
Hargarter John P. butcher, boards Tremont corner Reynolds
Hargarter Matthias, cigarmaker, 9 Caledonia avenue, b. Tremont c. Reynolds
Hargarter Matthias, mason, house 41 Grape
Hargrave Margaret, widow, boards 11 Grove
Harings C. Francis, sash maker, 13 Warehouse, house 9 McDonald avenue
Harison Richard, clerk, 132 Powers' bldgs. house 63 East avenue
Harison Richard N. clerk, b. 63 East avenue
Harkness Clarence M. bookkeeper, 43 State, boards 4 North Washington
Harland Sophia E. widow, house 9 Gibbs
Harley Geo. moulder, house Saratoga av. near Lorimer
HARLFINGER CHARLES, upholsterer and furniture repairer, 129 N. Clinton, house do.—*See page 628*
Harman John I. clerk, National Hotel, b. do.
Harman Joseph E. sailmaker, b. 49 Broadway
Harman J. Henry, blacksmith, b. 49 B'way
Harman Wm. B. carpenter, h. 49 Broadway
Harmon Herbert N. salesman, 73 East Main, boards 5 North Washington
Harmon John M. removed to Waterloo
Harmon Maria C. grocer, 13 Lowell, h. do.
Harnisfeger John, laborer, Clinton Hotel, h. 4 University avenue [56 Griffith
Harold Adam, carpenter, 97 Exchange, bds.
Harold Mary A. Mrs. seamstress, house 56 Griffith [b. 56 Griffith
Harold William U. shoemaker, 31 N. Water,
Harper George, trackmaster, house 73 Allen
Harper John, agent, boards Waverley House

Harper John, driver, 125 State, h. 11 Kent alley
 Harper John F. mason, boards 32 Asylum
 Harper Joseph, painter, 14 Stone, h. 21 do.
 Harper Mary, widow, house 63 Cady
 Harper Mary A. widow, house 32 Asylum
 Harper Rebecca, housekeeper, Brackett House, boards do. [b. 21 Stone
 Harper Sarah A. millinery, 125 East Main,
 Harper Thomas A. mason, boards 32 Asylum
 Harprry Gregory, carpenter, b. Caroline near Diem [Magne
 Harps Thomas jr. woodmoulder, house 84
 Harr Christian, shoemaker, house 14 Grand
 Harrie Joseph, machinist, house 3 Almira
 Harrigan Jerry, waiter, Osburn House
 Harrigan John, gardener, house 50 Meigs
 Harrigan Julia, widow, boards 18 Smith
 Harrigan Mary, domestic, Osburn House
 Harrigan Patrick, laborer, 215 State, h. 76 Oak [son], boards 23 Brown
 Harrington Chas. F. (*Harrington & Richard*-
 Harrington Daniel, laborer, h. 48 Tremont
 Harrington Eliza, widow, boards 2 Clifton
 Harrington Eugene, engineer, h. 80 South St. Paul [Clifton
 Harrington George H. boatman, house 2
 Harrington Jas. C. physician, 13 Smith's block, house 47 Court [Genesee
 Harrington James P. carpenter, house 39
 Harrington John, teamster, Osburn House, boards do. [*ardson*], h. 61 Oak
 Harrington Leonard B. (*Harrington & Rich*-
 Harrington Louisa, sewer, b. 50 Charlotte
 Harrington Maria, domestic, b. 111 Lake av.
 Harrington Mary, widow, house 50 Charlotte
 Harrington Michael, boards 161 St. Joseph
 Harrington Wm. H. carriagemaker, foot Centre, boards 23 Brown
 Harrington & Richardson (*C. F. and L. B. Harrington, and L. H. Richardson*), children's carriage manufs. foot Centre
 Harris Albert, teamster, Scottsville road near Rapids road
HARRIS BENJAMIN F. freight agent, Erie railway, 4 State, house 127 University avenue.—*See Railroads in Contents*
 Harris Calvin, cooper, boards 18 Ontario
 Harris Charles W. shoemaker, 75 N. Water, b. Conkey av. cor. avenue B
 Harris C. Henry (*Cowles & Harris*), 8 North Water, boards 129 University avenue
 Harris Daniel, removed from city
 Harris Daniel, builder, 3 Sycamore, house 52 Goodman [house 15 Avenue B
 Harris Daniel L. shoemaker, 75 N. Water,
 Harris Edward (*Harris & Cooke*), house East avenue near Sibley [Gates
 Harris Edwin L. printer, 74 Arcade, bds. at
 Harris Ellen, domestic, 32 Lake avenue
 Harris Frank L. salesman, 17 West Main, h. at Churchville [avenue
 Harris Frank M. printer, boards 96 Mt. Hope
 Harris George B. clerk, water works, City Hall, house 76 Kent
 Harris George B. Mrs. music teacher, 76 Kent, house do. [h. 30 Warner
 Harris Harvey C. compositor, 82 West Main,

Harris Hugh, machinist, Brown cor. Jones, house 15 Otsego [63 Litchfield
 Harris John F. bartender, 13 Arcade, house
 Harris John K. fireman, boards 8 Genesee
 Harris Joseph L. bookkeeper, 1 Andrews, house 129 University avenue
 Harris Locina, widow, house 136 Adams
 Harris Louise M. widow, house 12 Jackson
 Harris Mary Miss, 205 Plymouth av. boards 14½ Edinburgh
 Harris M. A. sleigh manufacturer, 17 Division, house Norton n. N. St. Paul
 Harris Orrin, builder, boards 58 Platt
 Harris Oscar, carpenter, house 7 Second av.
 Harris Sluman W. plumber, b. 96 Mt Hope av.
 Harris Solomon, servant, b. East av. c. Sibley
 Harris Stephen, brackets, h. 14½ Edinburgh
 Harris Thomas, carpenter, house 37 Gorham
 Harris Thomas, N. Water near E. Main, h. 108 University avenue
 Harris William, brackets, h. 14½ Edinburgh
 Harris William, milkman, house 87 Clifton
 Harris William, shoemaker, h. 8 George's pk.
 Harris William L. shoemaker, h. Conkey avenue, c. avenue B
 Harris Wilna C. boat builder, house 96 Mt. Hope avenue [n. N. St. Paul
 Harris Zebediah H. sleighmaker, h. Norton
 Harris & Cooke (*E. Harris and M. W. Cooke*), lawyers, West Main cor. Fitzhugh
 Harrison Camelia, widow, house at Rapids
 Harrison Charles A. produce, b. 40 Romeyn
 Harrison Daniel B. veterinary surgeon, house 8 Sherman
 Harrison George, blacksmith, Scottsville road at Rapids, house do. [Nassau
 Harrison Geo. fireman, N. Y. C. R. R. b. 58
 Harrison George N. (*Striker & Harrison*), 183 West avenue, house 185 do. [h. 30 Jay
 Harrison Henry, tailor, State corner Brown,
 Harrison Henry, student, boards 85 Court
 Harrison Henry W. clerk, bds. 30 Jay
 Harrison James, gardener, bds. 24 Bolivar
 Harrison James, bridgmaker, h. 9 Woodbury
 Harrison James H. engineer, h. 122 Frank
 Harrison James M. machinist, 20 E. Main, house Frank near Lorimer
 Harrison John M. (*Harrison & McQuade*), boards 30 Mumford
 Harrison Joseph, engineer, house 38 Ambrose
 Harrison Ophelia, stitcher, bds. 57 Bolivar
 Harrison Pamela, finisher, bds. 57 Bolivar
 Harrison Ralph, engineer, house 136 Oak
 Harrison Sarah Miss, dressmaker, 43 State, house do.
 Harrison Sarah, widow, house 58 Nassau
 Harrison Sarah, stitcher, boards 57 Bolivar
 Harrison Stephen, laborer, Brown c. Jones, house 57 Bolivar
 Harrison Walter M. painter, house 84 Frank
 Harrison William, removed from city
 Harrison William H. fireman, b. 58 Nassau
 Harrison William H. clerk, 8 Arcade, bds. Scottsville road at Rapids
 Harrison William J. agent, h. Thompson av. rear Leighton avenue
 Harrison & McQuade (*J. M. Harrison and J. McQuade*) painters, 2 South Washington

Harrith Joseph, door finisher, 13 Warehouse
 Harrold George W. crockery, 84 E. Main, h. 3 Johnson park [House
 Harrold John, clerk, 63 Front, b. County
 Harrold Mary E. boards 91 South avenue
 Harrold Sarah L. clerk, 22 E. Main, boards 91 South avenue [jail, b. do.
 Harroun Harmon V. turnkey, Monroe county
 Harry William C. captain, h. 12 Conkey av.
 Hart Andrew E. whipmaker, Allen c. N. Washington, boards 87 Nelson
 Hart Andrew S. patent right dealer, house 2 Phelps avenue
 Hart Annie E. teacher, boards 14 Pitt
 Hart Bridget, widow, house rear 63 Munger
 Hart Catharine T. Mrs. boarding house, 169 East Main
 Hart Charles, foreman, 184 State, h. 27 Hand
 Hart Charles E. house 61 Plymouth avenue
 Hart Chauncey H. salesman, b. 12 E. Main
 Hart Christian, carpenter, h. 51 Alexander
 Hart Christian F. shoemaker, 73 N. Water, house 28 Sellinger
 Hart Edward, laborer, house 76 S. Union
 Hart Edward P. (*J. M. Phelon & Co.*) 55 West Main, bds. 42 Plymouth avenue
 Hart Emma A. widow, boards 2 Phelps av.
 Hart Emma M. (*Goulding & Co.*), 30 Lake av. house do.
HART ERNEST, printer, 46 Oak, boards do.—See page 592
 Hart Frank N. marble cutter, 122 South St. Paul, house 29 Hickory
 Hart George, laborer, house rear 9 Julia
 Hart George S. clerk, house 35 Cherry
 Hart Henry, house 8 Franklin
 Hart Henry, house 3 Goodman
 Hart Henry jr. plumber, 66 E. Main, boards 3 Goodman [Alexander
 Hart Henry C. clerk, 126 State, boards 51
 Hart Henry F. house 22 Spring [18 Mathews
 Hart Henry L. engineer, 82 W. Main, house
 Hart Jacob J. clothing, 19 E. Main, boards 3 Goodman
 Hart James, harnessmaker, 241 State, h. do.
 Hart James C. (*W. S. Kimball & Co.*), 55 S. St. Paul, boards 27 East avenue
 Hart Jerome, farmer, h. Culver n. Webster road [302 State
 Hart John, broom maker, 5 N. Ford, boards
 Hart John, cabinetmaker, 7 N. Water, house Bay below toll-gate
 Hart John, shoemaker, 212 East Main, house 184 North Clinton [Union alley
 Hart John B. shoemaker, 73 N. Water, b. 12
 Hart John G. boatbuilder, h. 33 Mt. Hope av.
 Hart John R. marble cutter, 122 South St. Paul, house 5 Oregon
 Hart John W. clerk N. Y. C. ticket office, boards 109 Fitzhugh
 Hart Lina, widow, boards 16 Howell
 Hart Luke C. engineer, house 46 Oak
 Hart Mary A. widow, house 12 Union alley
 Hart Michael, laborer, house 87 Meigs
 Hart Moses, peddler, house 126 St. Joseph
 Hart Peter V. marble cutter, 122 S. St. Paul, house 44 Hickory [12 Union alley
 Hart Roman V. hairdresser, 159 E. Main, b.

Hart Romanta, house 19 East avenue
 Hart Roswell, water works com. City Hall, house 109 Fitzhugh
 Hart Roswell jr. boards 109 Fitzhugh
 Hart Roswell Mrs. house 109 Fitzhugh
 Hart Samuel & Co. (*J. A. Clark*), grocers, 333 State, house do.
 Hart Sylvester, removed to New York city
 Hart William, house 20 White
 Hart, see Hartt
 Hartel Andrew G. baker, boards 10 West av.
 Hartel George A. carriage trimmer, boards 10 West avenue
 Hartel John, saloon, 10 West avenue, h. do.
 Hartel John A. shoemaker, 83 North Water, h. 93 Wilder [Stone, h. 1 Johnson pk.
 Hartel Philip J. engineer, steamer No. 1, 36
 Hartell Anthony, carpenter, h. 105 W. Maple
 Hartell George, market, 46 Romeyn, h. do.
 Harter Andrew, saloon, Mill corner Factory, house 18 Hope
 Harter Balthasar, deceased May, 1875
 Harter Frances, widow, boards 98 St. Joseph
 Harter Frances, tailoress, bds. 7 Buchan pk.
 Harter Frank A. cartman, h. 7 Buchan park
 Harter Jacob, policeman, City Hall, house 21 McDonald avenue [Edward
 Harter Joseph, varnisher, 184 State, house 3
 Harter, see Hartter and Harder
 Hartigan Alice, widow, house 107 Frank
 Hartigan Jeremiah, machinist, b. 107 Frank
 Hartigan Mary A. Miss, seamstress, boards 107 Frank [Frank
 Hartigan Patrick, clerk, 4 Front, boards 107
 Hartigan Thomas, laborer, h. 27 Vincent pl.
 Hartigan William, moulder, rear 204 State, house 107 Frank [Morgan n. Clifton
 Hartley Charles, stonecutter, 8 West av. h.
 Hartley David, carpenter, Jones av. corner Saratoga av. h. Whitney corner Lime
 Hartley David jr. varnisher, bds. Whitney c. Lime [bds. 54 do.
 Hartley Hamilton, stonecutter, 22 West av.
 Hartley James J. druggist, boards 35 Frank
 Hartley Richard V. carpenter, h. 250 State
 Hartley William, carpenter, house 276 State
 Hartman Angeline E. (*Hartman & Brady*), boards 6 Greig
 Hartman Frederick, teamster, bds. 14 Grape
 Hartman George, boards 9 Sheridan park
 Hartman Jacob, packer, 81 E. Main, house 34 Rhine
 Hartman Joachim, tailor, house Alphonse
 Hartman John J. cabinetmaker, b. 9 Sheridan park [canal, h. 9 Sheridan pk.
 Hartman Joseph, cabinetmaker, Jay cor. Erie
 Hartman Joseph L. carpenter, bds. 6 Greig
 Hartman Louis, warehouseman, h. 273 State
 Hartman Louis jr. machinist, bds. 273 State
 Hartman Martin, carpenter, bds. 29 Holland
 Hartman William, policeman, City Hall, h. Stewart near North av. [house do.
 Hartman Wm. A. physician, 183 East Main, Hartman & Brady (*A. E. Hartman and A. P. Brady*), dressmakers, 18 East Main
 Hartmann George H. brakeman, N. Y. C. R. R. bds. 140 State [ham, b. 24 Scramont
 Hartmann Gustave, frame polisher, 38 Gor-

Hartmann Peter, shoemaker, h. 18 Stillson
 Hartnett Catharine Mrs. domestic, 2 Centre
 Hartnett Frank, shoemaker, 77 North Water,
 boards 14 Platt [b. 35 N. St. Paul
 Hartnett Jeremiah, shoemaker, 83 N. Water,
 Hartney Dennis W. waiter, Congress Hall,
 boards do.
 Hartshorn Bradley P. shoemaker, 15 Mill, b.
 16 North Clinton [99 Lake avenue
 Hartt John A. bookkeeper, 102 Exchange, h.
 Hartt William A. clerk, 76 State, boards 99
 Lake avenue [Nassau
 Hartter Sebastian, shoemaker, 15 Mill, h. 4
 Hartung Charles, turner, boards 144 Scio
 Hartupee Andrew W. physician, h. 92 Ful-
 ton avenue
 Hartupee Wm. F. house 206 East Main
 Hartwell James B. clerk, house 132 State
 Hartwig Ralph, removed to Philadelphia,
 Pennsylvania
 Harty John D. bookkeeper, house 132 State
 Harty Peter, planer, house 97 Frances
 Harvey Anna M. widow, house 40 Lorimer
 Harvey Charles N. carman, b. 143½ South av.
 Harvey Cyrus D. telegrapher, bds. 26 Hand
 Harvey Frances, forewoman, b. 48 Atwater
 Harvey Frank, musician, bds. 143½ South av.
 Harvey James C. salesman, 73 East Main, b.
 16 North Clinton
 Harvey Kate A. Mrs. house 26 Hand
 Harvey Mary, laundress, 14 N. St. Paul, bds.
 Osburn House [chester, b. 35 Howell
 Harvey Ransom, student, University of Ro-
 Harvey Reuben, house 143½ South avenue
 Harvey William F. boards 19 Leopold
 Harvey William H. clerk, boards 26 Hand
 Harvey Wm. T. conductor, N. Y. C. R. R.
 house 19 Leopold
 Harward Frank, carpenter, Walnut n. Camp-
 bell, house 18 North Frances
 Harwood Frank G. waiter, Osburn House,
 boards 1 Woodbury
 Haseltine Harvey B. (*Haseltine, Cowen & Co.*),
 14 Exchange, house 18 Pleasant
 Haseltine Syrene, widow, house 18 Pleasant
 Haseltine, Cowen & Co. (*H. B. Haseltine, W.
 W. Cowen, and I. F. Force*), underwear,
 14 Exchange
 Haseman John, machinist, 154 North Water
 Hasenaure Ada, tailoress, boards 31 German
 Hasenaure Henry, mason, boards 31 German
 Hasenaure Mary, tailoress, bds. 31 German
 Hasenaure Thomas, mason, house 31 German
 Haskell Caroline, widow, house 40½ Fitzhugh
 Haskin Curtis H. (*Reese, Higbie & Haskin*),
 66 West Main, house 20 Magne
 Haskin Ira, house 319 East Main
 Haskin Mary Miss, boards 319 East Main
 Haskin Oscar S. fireman, house rear E. Main
 near railroad [35 University av.
 Haskin Alexis T. painter, 74 Arcade, boards
 Haskins Edwin L. house 183 Monroe avenue
 Haskins Neville E. clerk, 110 West Main, bds.
 35 University avenue
 Haskins Ralph T. watchmaker, 163 E. Main,
 house 35 University avenue
 Haskins Sarah, widow, house 183 Monroe av.
 Haskins William, machinist, h. 36 Litchfield

Hasler John, waiter, boards N. Clinton near
 Bloomingdale avenue
 Hasler Josephine, widow, h. N. Clinton near
 Bloomingdale avenue
 Hasnor Roman A. cigarmaker, b. Shamrock
 near Ringlestein alley [avenue
 Hason James, salesman, 17 State, h. 11 Jones
 Hason John, blacksmith, Brown cor. Jones,
 boards 129 Jones
 Hason Thomas, removed from city
 Hass Adam, laborer, h. Fourth avenue n. Bay
 Hassan Midbury W. clerk, Erie Railway
 freight office, boards 66 Allen
 Hassan William B. laborer, boards 66 Allen
 Hassan William E. house 66 Allen
 Hassel Francis J. hairdresser, 227 North
 Clinton, boards 230 do.
 Hasselwander Anthony, painter, b. 155 Jay
 Hasselwander Geo. boatbuilder, h. 155 Jay
 Hasselwander Martin, laborer, bds. 155 Jay
 Hasslinger Joseph, foreman, 44 Exchange,
 boards 13 Granger
 Hastings Albert M. pres. and supt. Roches-
 ter Paper Co. lower falls, h. 9 Phelps av.
 Hastings Ann E. widow, bds. 10½ Comfort
 Hastings Charles E. chemist, h. Goodman n.
 Monroe av.
 Hastings Charles S. student, b. 9 Phelps av.
 Hastings Francis S. farmer, h. Culver cor.
 Webster road [St. Paul
 Hastings Lyman H. freight agent, bds. 27 N.
 Hastings L. H. Mrs. millinery, 2 Elwood bl.
 boards 27 North St. Paul
 Hastings Melville, house 68 Andrews
 Hastings Sophia Miss, boards 22 Mathews
 Hastings William H. (*Hastings & Toole*), b. 4
 Spencer [house 68 Andrews
 Hastings William M. M. health lift, 54 State,
 Hastings & Toole (*W. H. Hastings and W. J.
 Toole*), dry goods, 264 State
 Haszfetter Adam, machinist, b. 5 Wadsworth
 Haszfetter Anna, widow, h. 5 Wadsworth
 Hatch Andrew J. shoe counter manuf. River
 c. N. Water, house 8 Pleasant
 Hatch Charles, boards 100 West avenue
 Hatch Charles B. (*J. W. Hatch & Son*), h.
 37 Charlotte
 Hatch Geo. W. mason, house 47 Charlotte
 Hatch Hattie, boards 4 Ambrose
 Hatch Hiram H. house 4 Ambrose
 Hatch James L. crimper maker, house 1 Vine
 Hatch Jesse W. & Son (*C. B. Hatch*), shoe
 manuf. 124 Front, house 56 N. St. Paul
 Hatch John N. cutter, 124 Front, h. 35 Oak
 Hatch Julia, widow, bds. 100 West avenue
 Hatch Patent Crimper Co. River cor. North
 Water
 Hatfield Beatrice, stitcher, bds. 5½ Granger
 Hatfield Julia, dressmaker, bds. 9 Lorimer
 Hathaway Charlotte, boards 1 Fitzhugh
 Hathaway David C. carpenter, house 4 Con-
 cord avenue [h. 24 S. Washington
 Hathaway Henry B. (*Hathaway & Gordon*),
 Hathaway Jerome, transportation agent, h.
 21 Marshall
 Hathaway John B. b. 24 South Washington
 Hathaway J. Charles, agent, 65 North Water,
 boards 24 S. Washington

Hathaway J. Henry, driver, 37 State, house 42 Lowell
 Hathaway L. M. Mrs. house 16 Marshall
 Hathaway Samuel B. bottler, 65 N. Water, bds. 170½ West Main
 Hathaway & Gordon (*H. B. Hathaway, C. Gordon, and special, Susan Bevier* \$30,000; *terminates Sept. 1, 1878*), brewers, 65 North Water
 Hatter Sebastian, shoemaker, house 4 Nassau
 Hatterscheit Joseph W. shoemaker, bds. 136 Hudson [house do.]
 Hatterscheit Peter, shoemaker, 136 Hudson, Hattrich Rebecca, widow, bds. r. 9 Comfort
 Hauber Joseph, carpenter, h. 139 W. Maple
 Hauck George, cooper, h. 126 Caledonia av.
 Hauck Henry, mason, house 94 Campbell
 Hauck John, gilder, boards 126 Caledonia av.
 Hauck Louis, card stripper, bds. 122 Wilder
 Haug George H. sawyer, 136 Mill, house 6 Hayward park [33 Galusha
 Haug William, optician, 179 N. St. Paul, h. Houghton Wm. A. rem'd to Cleveland, Ohio
 Hauk John, laborer, house 53 Henry
 Haungs August, clerk, 278 Brown, boards do.
 Haungs Joseph, saloon, 4 W. Maple, h. do.
 Haungs Mary A. grocer, 278 Brown, h. do.
 Hauser Andrew, basket maker, h. 19 Grand
 Hauser Andrew, laborer, h. Childs n. Lyell
 Hauser August, candymaker, b. 110 North av.
 Hauser August, basketmaker, bds. 19 Grand
 Hauser Christian jr. driver, 143 E. Main, b. 110 North avenue [house do.]
 Hauser Christian, saloon, 110 North avenue,
 Hauser Henry, machinist, foot Platt, boards 24 Childs
 Hauser Jacob, carpenter, house 15 Cole
 Hauser Matthias, peddler, h. 15 Hamburg
 Hauser Xavier, tailor, house 98 St. Joseph
 Hausner John, cooper, house 190 Orange
 Hausner John jr. cooper, Magne opposite Walnut, boards 190 Orange
 Hauss Simon, wagonmaker, h. 8 Wadsworth
 Havard Ellen, widow, house 170 Orange
 Haven Albert R. removed from city
 Haven Etta E. laundress, House of Refuge, boards do. [ton avenue
 Haven Wm. A. civil engineer, house 92 Ful-
 Havens Junior, laborer, boards 65 West av.
 Havens Mary, domestic, East avenue cor. Alexander
 Havens Merinda, widow, b. 188 West Main
 Havens Silas M. clerk, 112 State, h. 74 Pearl
 Haver Albert A. removed to Detroit, Mich.
 Haver George, deceased June, 1875
 Haver Libbie C. music teacher, bds. 62 Court
 Haver Mary A. widow, house 62 Court
 Havery Mary, domestic, Osburn House
 Haviland Morgan N. actor, b. 119½ E. Main
 Havill Arthur C. P. clerk, boards 55 Vienna
 Havill Eric E. shoemaker, 83 N. Water, bds. 55 Vienna
 Havill Frederick, brakeman, bds. 47 Martin
 Havill Harold H. carpenter, bds. 55 Vienna
 Havill Susan Miss, teacher, Andrews school, No. 9, boards 8 Delevan
 Havill Thomas, physician, 55 Vienna, h. do.
 Havill Ula E. machinist, boards 55 Vienna

Havlin Wm. paver, house 56 Bartlett
 Havner Hyman, tailor, 43 E. Main, house 23 Catharine [city line
 Hawes John C. laborer, bds. Chili road near Hawes Miles, laborer, bds. Chili road near city line [78 Champlain
 Hawken Albert N. painter, 14 Stone, house Hawken Arthur N. painter, h. 47 S. Union
 Hawken Wm. G. painter, 14 Stone, house 76 Champlain [17 Frank
 Hawkins Ebenezer, salesman, 129 State, h. Hawkins Frank M. clerk, Ayer's Hotel, b. do.
 Hawkins Fred. J. clerk, 17 Reynolds, b. do.
 Hawkins Geo. B. grocer, 17 Reynolds, h. do.
 Hawkins Jeremiah, deceased November, 1875
 Hawkins John, carpenter, house Cliff near Lake avenue
 Hawkins John, teamster, Exchange opposite Troup, house 3 Garden
 Hawkins John, boat builder, Meigs st. bridge, house Caroline near Pinnacle avenue
 Hawkins Mahala, widow, house 87 Court
 Hawkins Salome Mrs. house 86 Platt
 Hawkins Samuel, mason, boards Monroe av. near Boardman
 Hawks Haywood, assistant cashier, Powers' banking house, 1 State, b. 85 Fitzhugh
 Hawks Thomas, patent rights, h. 85 Fitzhugh
 Hawks Thomas jr. ass't teller, City Bank, 34 State, boards 85 Fitzhugh
 Hawkswell John, boot treer, 55 Mill, h. 93 Tremont
HAWLEY GEORGE, grocer, 102 West av. boards 7 Madison.—*See page 554*
 Hawley Lottie, widow, boards 88 North av.
 Hawley, Myers & Co. (*N. G. Hawley, R. M. Myers, J. F. Holmes and J. F. Bentley*), stationers, 55 State
 Hawley Nelson G. bookbinder, 55 State, and (*Hawley, Myers & Co.*), house 23 South Washington [Frank
 Hawthorne Bella, domestic, Lorimer corner
 Hax Gertrude, widow, b. 154 Plymouth av.
 Hax J. Philip, hackdriver, h. 128 W. Main
 Hax William, hackman, b. 154 Plymouth av.
HAY JOHN, watches, jewelry and silver ware, 53 West Main, house 13 N. Ford, —*See page 516*
 Hay William, 53 West Main, b. 13 N. Ford
 Hay, see Hey
 Hayd Frederic, mason, bds. 100 East avenue
 Hayd John B. gilder, bds. 100 East avenue
 Hayd John R., Bellevue Hotel, 100 East av.
 Hayde Richard, groom, 4 Otsego, b. Collins House [house do.]
 Hayden Catharine Mrs. saloon, 206 State,
 Hayden Charles A. (*C. J. Hayden & Co.*), bds. 107 Fitzhugh [house 41 Madison
 Hayden Charles C. engineer, N. Y. C. R. R.
HAYDEN CHARLES J. & CO. (*W. C. Bush and C. A. Hayden*), chair and cabinet manufacturers, 184 and 186 State, h. 107 Fitzhugh.—*See page 613*
 Hayden Henry D. truss hoop maker, b. 57 Asylum
 Hayden James, laborer, 79 Front, b. 1 Jones
 Hayden James A. student, University of Rochester, boards 57 East avenue

Hayden James E. & Co. (*O. E. Hayden and J. Hamer*), furniture, 73 State, h. 57 East avenue
 Hayden Jane E. widow, house 2 School al.
 Hayden Mary A. widow, h. 206½ W. Main
 Hayden Minerva A. Miss, principal, Chestnut School, No. 11, b. 57 Asylum
 Hayden Oscar E. (*J. E. Hayden & Co.*), house West avenue near Ames [Asylum]
 Hayden Phebe A. Miss, milliner, boards 57
 Hayden Walter M. foreman, h. 43 Madison
 Hayden Willard C. fireman, bds. 41 Madison
 Hayden John C. policeman, City Hall, h. 19 Favor
 Hayes Charles H. roofer, house 25 Strong
 Hayes Delia B. widow, house 40 Greig
 Hayes Eliza, bds. East av. corner Alexander
 Hayes Elizabeth, widow, bds. Church Home, Mt. Hope avenue
 Hayes Emma A. C. Miss, teacher, Genesee School, No. 4, bds. 11 Madison [av.
 Hayes Evis, widow, h. Munger n. Pinnacle
 Hayes Gordon, house 11 Madison
 Hayes Hannah, widow, boards 86 Adams
 Hayes James, boards Murray near Lyell
 Hayes James, waiter, boards 299 State
 Hayes James, maltster, boards 37 Platt
 Hayes James B. salesman, 16 Exchange, h. 18 Prospect [house, b. 40 Greig
 Hayes James F. clerk, Erie railway freight
 Hayes James M. clerk, 314 State, b. 6 White
 Hayes John & Co. (*J. K. Courneen*), grocers, 22 S. St. Paul, house 15 Hamilton place
 Hayes John, moulder, Brown's race n. Furnace, boards 13 Frances
 Hayes Lawrence, moulder, Brown's race n. Furnace, boards 13 Frances
 Hayes Marion G. widow, h. 111 Fitzhugh
 Hayes Marquis D. L. (*Rowley & Hayes*), 8 State, h. 33 Adams
 Hayes Mary, widow, h. 13 N. Frances
 Hayes Michael, laborer, Charlotte junction, house Murray near Lyell
 Hayes Morris, laborer, house 11 Kent alley
 Hayes Patrick J. boatman, h. 10 Alexander park [der park
 Hayes Richard T. plumber, bds. 10 Alexander
 Hayes Rose, widow, house 9 Otsego
 Hayes Thomas, mason, house 299 State
 Hayes Thomas jr. painter, boards 299 State
 Hayes Thomas, teamster, house 79 Cypress
 Hayes Thomas, foreman, Vacuum Oil Works, house Bond corner Averell
 Hayes William H. laborer, h. 131 S. St. Paul
 Hayes William H. laborer, boards 25 Strong
 Hayes, see Hays, Hay and Hey [Chestnut
 Hayken Martin (*Hayken & Hensel*), house 52
HAYKEN & HENSEL (*M. Hayken and Julius Hensel*), fresco painters, 88 Arcade.
 —See page 591
 Haynes William A. carpenter, h. 79 Moore
 Hays Andrew, cooper, Magne opp. Walnut, house West near Costar
 Hays Caroline, widow, boards 35 N. Clinton
 Hays David, student, University of Rochester, b. 39 N. Clinton
 Hays Edward, steamfitter, 25 Exchange, h. 69 Magne

Hays Edward J. lamp lighter, b. West near Costar
 Hays Ferdinand & S. clothiers, 76 Mill, h. 28 N. St. Paul [Atwater
 Hays Henry A. salesman, 76 Mill, boards 85
 Hays Isaac M. (*M. Hays & Co.*), b. 39 North Clinton
 Hays Louis, clerk, 74 Mill, b. 18 Clinton pl.
 Hays Marx, salesman, 68 Mill, h. 13 Hudson
 Hays Maurice S. bookkeeper, 76 Mill, bds. 60½ Andrews [Mill, h. 39 N. Clinton
 Hays Moses & Co. (*J. M. Hays*), clothing, 68
 Hays Moses A. rag dealer, 111 Mill, house 85 Atwater [Atwater
 Hays Moses A. salesman, 76 Mill, boards 85
 Hays Simon (*F. & S. Hays*), h. 60½ Andrews
 Hayton Joseph, flour, 34 South av. h. 30 do.
 Hayward Edmund B. horse dealer, house 92 Munger
 Hayward Edwin S. seed grower, house 60 Goodman near Schanck avenue
 Hayward Fannie C. Mrs. dressmaker, 42 State, house do.
 Hayward George C. photographer, 55 East Main, boards 12 North Washington
 Hayward Nathaniel, farmer, house Goodman near Schanck avenue
 Hayward Walter S. machinist, boards North Clinton n. Bloomingdale avenue
 Haywood Prudence, widow, h. 9 Fitzhugh
 Haywood Thomas F. salesman, b. 9 Fitzhugh
 Haywood Wm. S. boards 9 Fitzhugh
 Hazard Alexander C. clerk, 118 W. Main, b. 1 Madison park
 Hazard Ann Mrs. house 19 Sherman
 Hazard Catharine F. Miss, boards 263 North St. Paul
 Hazard Dora J. forewoman, b. 1 Madison pk.
 Hazard Edward R. clerk, 156 State, boards 42 Sherman [11 do.
 Hazard Hugh, cooper, 1 St. James park, b.
 Hazard James, cooper, 1 St. James park, h. 11 do.
 Hazard James, peddler, b. 1 Madison park
 Hazard John, street car driver, b. 25 Allen
 Hazard John R. teamster, bds. 19 Sherman
 Hazard Mary A. Mrs. house 1 Madison park
 Hazel Samuel Z. teamster, bds. 59 Spring
 Hazelgrove Fred. hostler, bds. 20 Johnston block [ston block
 Hazelgrove George, laborer, boards 20 Johnston
 Hazen Wm. H. carpenter, house Hollister n. Channing [12 Brighton av.
 Hazlip John, engineer, gas works, house
 Hazlip Thomas, laborer, b. 12 Brighton av.
 Hancock Albert, coachman, bds. 274 State
 Headley Alzna P. boards 62 Chestnut
 Healion Nellie, stitcher, b. 14 Gardner park
 Healy Catharine, widow, house Mansion n. Magnolia
 Healy Daniel, grocer, 161 Scio, house do.
 Healy Daniel P. blacksmith, 277 State, house Stone cor. Ely
 Healy James, sawyer, b. Mansion n. Magnolia
 Healy John, laborer, bds. First near Rowe
 Healy John, blacksmith, house 5 Kent
 Healy John C. file forger, 107 Mill, h. First near Rowe

Healy Mary A. domestic, boards 54 East av.
 Healy Patrick, laborer, bds. First near Rowe
 Healy Patrick J. sawyer, Exchange n. Troup,
 house Mansion near Magnolia
 Healy Thomas, deceased June 6, 1875
 Healy William E. removed to Buffalo
 Heaney Bernard J. cutter, b. r. 147 Exchange
 Heaney James P. shoemaker, house Ritter
 Heaney James P. jr. cutter, boards Ritter n.
 Exchange [rear 147 Exchange
 Heaney John C. shoecutter, 77 N. Water, b.
 Heaney Patrick, clerk, 147 State, house 61
 Bartlett
 Heard Mary, widow, boards 16 Chatham
 Heard Walter, 68 Powers' buildings, boards
 Osburn House
 Hearty Frank, blacksmith, house 120 Scio
 Hearty Joseph, laborer, house 83 Davis
 Hearty Peter, teamster, house 82 Ontario
 Heath Edwin S. ironing tables, Aqueduct,
 near canal, house 47 Ambrose
 Heath Eldridge (*Fish & Heath*), house 132
 Plymouth avenue
 Heath Emma, whipmaker, boards 23 Jay
 Heath Frederick, coachman, b. East avenue
 corner Prince [50 Clifton
 Heath George B. clerk, 21 West Main, bds.
 Heath George H. student, boards 143 Frank
 Heath Henry C. gardener, house 288 E. Main
 Heath James L., Rochester Boot manuf. Co.
 81 North Water, house 10 Elm
HEATH JOHN G. building mover, house
 186 North St. Paul.—*See page 642*
 Heath Nathan B. removed to Livonia
 Heath Thomas, coachman, 4 Fitzhugh, b. do.
 Heaton Lucy A. widow, house 159 Scio
 Heavey George, clerk, 115 University av.
 house 19 Andrews [Andrews
 Heavey Henry, foreman, 83 Front, boards 19
 Heavey Mary A. Miss, boards 19 Andrews
 Heavey Michael, livery stable, 85 Front, h.
 19 Andrews [Andrews
 Heavey Peter H. clerk 83 Front, boards 19
 Hebard Charles W. marblecutter, 122 South
 St. Paul, house 112 do.
 Hebard Frederick, letter carrier, Post Office,
 house 111 Plymouth avenue
 Hebard George, surveyor, b. 112 S. St. Paul
HEBARD HENRY S. marble dealer, 122
 H South St. Paul, house 11 Howell.—*See*
front colored page
 Hebard Joseph, flagman, Litchfield st. cross-
 ing, house 45 N. Frances
 Hebard Oliver, shoemaker, 7 South St. Paul,
 house 45 N. Frances
 Hebard Reuben, umbrella maker, 48 Monroe
 avenue, house 60 Broadway
 Hebard Samuel, boards 112 S. St. Paul
 Hebbard Alvah, salesman, boards 19 Elm
 Hebbard Frances, matron, City Hospital,
 boards do.
 Hebbard Ira A. house 19 Elm
 Hebbard, see Hebard and Hibbard
 Heberger August, shoemaker, 124 Front, h.
 18 Almira
 Heberger Frank, laborer, b. 214 N. Clinton
 Heberger Geo. M. mason, h. 121 N. St. Paul
 Heberger Jacob, clerk, boards 33 Hand

Heberger Jacob, mason, h. 265 N. Clinton
 Heberger Jacob, mason, h. 284 N. Clinton
 Heberger Jacob M. cigarmaker, boards 214
 North Clinton [Almira
 Heberger John, salesman, 26 N. Water, h. 28
 Heberger John, saloon, 112 N. Clinton, h. do.
 Heberger Martin, deceased Sept. 1875
 Heberger Martin Mrs. grocer, 214 N. Clinton,
 house do. [h. 224 N. Clinton
 Heberger Martin, jr. shoemaker, 79 N. Water,
 Heberger Martin 2d, mason, 16 Stone, boards
 5 Rauber
 Heberger Mary U. house 33 Hand
 Heberger Michael, mason, h. 267 N. Clinton
 Heberger Valentine, mason, 121 N. St. Paul
 Heberger Wm. M. clerk, 214 N. Clinton, h.
 15 Morris
 Heberle Joseph, removed to Holly
 Heberling Elizabeth A. Miss, housekeeper,
 h. 115 Alexander
 Heberling George (*T. & G. Heberling*), 61
 Monroe av. h. do.
 Heberling Henry, expressman, 83 State, bds.
 115 Alexander [115 Alexander
 Heberling Joseph, clerk, 69 W. Main, boards
 Heberling Thomas & G. flour and feed, 61
 Monroe av. house Pearl n. Meigs
 Heberling Wm. (*Feshery & Heberling*), 222
 West Main, boards Adams cor. Exchange
 Hebing Anthony, musician, h. 64 Munger
 Hebing Christina, fancy goods, 31 Grand,
 house do.
 Hebing Gertrude, widow, boards 77 South av.
 Hebing Henry, hardware, 74 E. Main, house
 45 North avenue [31 Grand
 Hebing Wm. optician, 179 N. St. Paul. bds.
 Hebsher Wm. tailor, house 248 N. Clinton
 Hechinger Isador, 58 W. Main, b. 103 Court
 Hechinger Ludwig, optician, 58 W. Main, h.
 103 Court
 Hecht Uriah J. 68 Mill, boards 71 N. Clinton
 Heck Henry, brewer, 106 N. Clinton, house
 6 Widman
 Heckel John, cutter, 79 N. Water, b. 67 Lowell
 Heckel John C. policeman, City Hall, house
 67 Lowell
 Hecker Rudolph, machinist, house 29 Wilder
 Heckert Margaret, knitting, h. 39 Franklin
 Heckmann Charles, teamster, house Lewis
 Heckner George, stone cutter, b. 155 Hudson
 Heckner George, piano maker, 4 Hill, house
 25 Oakman [near Clifford
 Heckroth George, farmer, house North av.
 Heckroth Henry, shoemaker, 77 N. Water, h.
 North avenue near Clifford
 Heckroth Peter, tailor, house 108 North av.
 Hedditch George, butcher, 293 State, boards
 Lyell near Childs [Lyell n. Childs
 Hedditch Henry, market, 293 State, house
 Hedditch Robert, butcher, 293 State, boards
 Lyell near Childs
 Hedger Gertrude, milliner, boards 180 State
 Hedges Amanda J. house 17 Greig
 Hedley Elizabeth C. photographer, 98 State,
 boards do.
 Heech Bardel, laborer, house 38½ Gregory
 Heech Jacob, butcher, 59 S. Clinton, b. do.
 Hefferan Mark, laborer, house 22 Caroline

Hefferanan Michael, switchman, Montgomery alley, house Ontario near Union
 Hefner Anne, widow, house 3 Griffith
 Hefner Anthony, baker, 37 Scio, house 13 Charlotte [Paul, b. 3 Griffith
 Hefner Charles W. casket maker, 22 S. St. Hefner see Hafner
 Hegeman Charles S. hair dresser, 14 Powers' buildings, house 32 Comfort
 Hehn Charles, tailor, house 4 Thomas
 Heibaum Johanna W. widow, h. 102 Chatham
 Heiber Charles M. laborer, b. 6 North York
 Heiber John, stove moulder, 187 E. Main, h. 6 North York c. R. R. [6 N. York
 Heiber John M. shoemaker, 79 N. Water, b. Heiby Louis, clerk, 94 East av. b. 2 Park av.
 Heick Charlotte, widow, boards 10 Pitt
 Heidelberg Joseph, mason, house 62 Weld
 Heiden Charles, mason, house 37 Scramton
 Heiden Frederick, laborer, house 25 Rhine
 Heider Charles F. deceased, April, 1876
 Heilbronn Christian, saloon, 169 East Main, house do.
 Heilbronn Frederick, grainer, h. 19 Morris
 Heilbronn Henry, peddler, house 49 Hand
 Heilbronn Jacob, musician, b. 28 St. Joseph
 Heilbronn Joseph H. cigar maker, 33 Monroe av. boards 49 Hand
 Heilbronn Lewis, saloon, 85 Chatham, h. do.
 Heilig Frederick, cooper. 12 Martin, b. 122 Front
 Heilman Frank J. finisher, house 50 Baden
 Heilman John, finisher, 15 N. Water, house Ulm near Hoyt
 Heilman John D. saloon, 109 Hudson, h. do.
 Heilmann Conrad, laborer, boards Averill cor. Cobb [h. 119 Lyell
 Heim Andrew, watchman, Charlotte junction,
 Heim Ignatz, tailor, h. Ames p. W. Maple
 Heim John A. tailor, Weeger near Thomas, house do.
 Heim John P. wagon maker, h. 18 Vienna
 Heiman David, peddler, h. 75 St. Joseph
 Hein Jacob, carpenter, house 141 Hudson
 Heindl Frank, laborer, house Alphonse near Thomas [Alphonse n. Thomas
 Heindl Leopold, box maker, 149 N. Water, b. Heindl Lewis, printer, boards 113 Chatham
 Heindl Louis, boot treer, house 113 Chatham
 Heindl Louis jr. (*Bostwick & Heindl*), printers, 2 East Main, house 36 Lowell
 Heindl Nicholas J. cabinet maker, 155 North Water, house 45 Kelly
 Heinebuch Henry, blacksmith, h. Waverley place near canal [house do.
 Heiness Unies Miss, hairdresser, 47 N. Clinton,
 Heininger Lawrence, tailor, house Goodman near Bay
 Heininger Margaret, widow, house 5 Wait
 Heinele Adam, cutter, 24 State, h. 2 Romeyn
 Heinele Christian, cutter, 76 Mill, house 26 Broadway
 Heinoth Joseph, carpenter, house 276 North
 Heindold Frederick, nurseryman, h. Mt. Vernon avenue near Lewis
 Heindold Henry J. tinsmith, 144 East Main
 Heindold Margaret B. widow, h. Mt. Vernon avenue near Lewis

Heinrich William, removed to Brockport
 Heins Henry, shoemaker, h. Hoyt near Ulm
 Heinsler Ignatz, bootmaker, Andrews c. N. Water, house North av. n. Norton
 Heintz Jacob, tailor, 10 West Main, house 1 McDonald avenue [38 Madison
 Heintz Wm. H. silver plater, 3 Canal, boards
 Heintz Magdalene, widow, house 38 Madison
 Heintzle Mary, widow, h. Webster road near Goodman [ster road near Goodman
 Heintzle Vincent, plumber, 17 Mill. b. Web-Heintzleman Marion, widow, h. Schanck av. near Goodman [bds. North av.
 Heintzle Charles, shoemaker, 20 Catharine,
 Heisel Andrew, printer, 18 N. St. Paul, bds. 74 Frances
 Heisel Christina, widow, house 318 Brown
 Heisel George, machinist, 123 Mill, bds. 318 Brown
 Heisel Henry, tool maker, house 74 Frances
 Heisel Henry M. removed from city
 Heisel John, machinist, boards 318 Brown
 Heiser see Hiser
 Heisinger John, blacksmith, h. 12 Hebard
 Heisinger Joseph, wood yard, rear 255 North Clinton, house 30 Conkey av. [Joiner
 Heislein Anton, moulder, 20 Court, house 63
 Heislein Frank, upholsterer, bds. 63 Joiner
 Heisler Adam J. laborer, r. Exchange near Court, house 50 Martin [b. 50 Martin
 Heisler Anthony, cabinet maker, 184 State,
 Heisler Eva, widow, boards 54 Vienna
 Heisler John, cabinet maker, 184 State, bds. 50 Martin
 Heisner Charles, dooper, house 43 St Joseph
 Heisner Rebecca Mrs. dressmaker, 43 St. Joseph, house do. [h. 2 Waverley pl.
 Heister Frederick, stonecutter, 22 West av.
 Heiter Charles, saloon, 33 St. Joseph, h. do.
 Heiter Charles F. deceased April 29, 1876
 Helberg Constantine, shoemaker, 77 North Water, house 40 Thomas [man
 Helburgh Frederick, machinist, bds. 54 Her-
 Helbert James, marble polisher, 122 South St. Paul, house Mt. Vernon avenue
 Helbing August, shoemaker, 77 N. Water, house 26 Hoelfer [138 Lake av.
 Held Alois, cabinetmaker, foot Rowe, house
 Held Christiana, widow, h. 61 Mt. Hope av.
 Held Frank X. cabinet maker, foot Rowe, b. 138 Lake avenue [18 Hanover
 Held Florian, wheelmaker, 3 Elizabeth, bds.
 Held George, sawyer, River near North St. Paul, bds. 260 Jay [Mt. Hope av.
 Held Henry M. sawyer, 184 State, boards 61
 Held Jacob, painter, house 3 North York
 Held Jacob, saloon, 17 Mt. Hope av. h. do.
 Held Joseph, shoemaker, 91 North Water, house 107 North avenue near Clifford
 Held Joseph A. engineer, Brown cor. Jones, house 81 Chatham
 Held Mary, widow, house Jay near Ames
 Held William, clerk, 73 Mill, boards 61 Mt. Hope avenue
 Helena Mary Sister, teacher, St. Bridget's School, boards Jay corner Frank
 Helfer Charles, blacksmith, North Water c. Mortimer, house 33 Wilder

HENRY C. WISNER,

THE CELEBRATED (SOLE AGENCY) "MOSELLE WARE"---No. 33 STATE STREET.

Helper Henry, teamster, h. 124 Pinnacle av.
 Helper Jacob, tailor, 287 N. Clinton, h. do.
 Helper John A. collar maker, 129 State, h. 124 Pinnacle avenue
 Helper Joseph, laborer, boards 88 Pearl
 Helper Nicholas, dry goods, 140 North Clinton, house do.
 Helfiker Jacob, mason, house 22 Lewis
 Hellems Charles C. clerk, 4 Griffith, b. 42 Oak
 Hellems Charles F. carpenter, house 42 Oak
 Hellems Isaac, carpenter, 18 Oak, h. 12 do.
 Heller Agnes, widow, bds. 191 North Clinton
 Heller Cecilia, widow, h. Miller near Bay
 Heller Charles, cabinet maker, 184 State, h. 29 Lowell [40 Delevan
 Heller Edward, letter carrier, post office, h.
 Heller Edward H. clerk, 57 North Clinton, boards 12 do.
 Heller John, mason, boards 32 Front
 Heller Joseph, grocer, 24 William, house do.
 Helling Charles, moulder, house 12 University avenue [av.
 Helling Henry T. cutter, bds. 12 University
 Helling John, marble cutter, 166 State, bds. 12 University avenue
 Hellyar Thomas, miller, house 32 Smith
 Hellwing August, shoemaker, h. Hoelfer near N. Clinton [h. Hollenbeck
 Helmbold George, bootmaker, 123 E. Main,
 Helmrich Anton, student, Roch. Theological Seminary, bds. 118 Alexander
 Hemaen Fred, laborer, 187 West Main, house 46 Gregory [bds. do.
 Hembrough George, hostler, Farmers' Hotel,
 Hemeley Annie, stitcher, boards 28 Bolivar
 Hemingway Harvey C. (*H. F. Hemingway & Co.*), 123 State, boards 12 Frank
HEMINGWAY HENRY N. hardware manuf. 150 North Water n. railroad, h. 13 South Clinton.—*See page 679*
HEMINGWAY H. F. & CO. (*H. C. Hemingway*), oyster packers, and fruit dealers, 123 State, boards 12 Frank.—*See page 575*
 Hempel Charles, mason, house 6 Hawkins
 Hempel Charles, blacksmith, 120 Mill, house 55 Scrantom
 Hempel Christian, mason, house Ulm n. Bay
 Hempel Joseph, carpenter, house 15 Galusha
 Hempel Thomas, tailor, bds. 19 Hamburg
 Hempel William, cabinetmaker, 133 North Water, boards 21 Hawkins
 Hempstead Charles, farmer, h. 33 Hudson
 Hempstead John Q. A. bookkeeper, 25 West Main, house 5 William
 Henchen Abbie Miss, house 37 Broadway
 Henchen Francis, deceased August, 1875
 Henchen Frederick, cooper, West n. Lyell, house 103 Wilder
 Henchen Joseph, cooper, Smith near Erie canal, house 101 Jay
 Henchen Joseph jr. cooper, h. 127 Childs
 Hendee Henry F. printer, 3 West Main, bds. 113½ E. Main
 Hendel Andrew, laborer, house Goodman opp. Pennsylvania av.
 Hendel Conrad, wagonmaker, 35 S. St. Paul, boards Goodman opp. Pennsylvania av.

Hendel Michael, plumber, 48 Exchange, bds. Goodman opp. Pennsylvania av.
 Hendel Valentine, marble cutter, 122 S. St. Paul, b. Goodman opp. Pennsylvania av.
 Hendershott Fred. E. photographer, boards 68 South St. Paul
 Henderson Ann E. widow, h. 7½ Manhattan
 Henderson Edward H. B. agent, 55 E. Main, house 31 Monroe avenue
 Henderson Frank S. stitcher, bds. 4 Bloss
 Henderson George L. shoemaker, 124 Front, house 35 Fulton avenue
 Henderson George W. foreman, 124 Front, house 4 Bloss [b. 13 N. St. Paul
 Henderson Henry B. cutter, 82 West Main,
 Henderson Horace, blacksmith, bds. 4 Bloss
HENDERSON JAMES, merchant tailor, 82 W. Main, house 2 N. Washington.—*See page 539*
 Henderson James, carpenter, 39 South Ford, house 24 Trowbridge
HENDERSON JAMES MRS. domestic patterns and sewing machines, 52 State, h. 2 North Washington.—*See page 548*
 Henderson John, shoemaker, 83 N. Water, house 84 Cady [Manhattan
 Henderson John W. cutter, 10 Mill, bds. 7½
 Henderson Josephine, dressmaker, boards 7½ Manhattan [hanttan
 Henderson Julia, dressmaker, bds. 7½ Man-
 Henderson Martin, trimmer, 73 N. Water, boards 12 Swan
 Henderson Thomas, mason, house 86 Clifton
 Henderson Thomas, fruit stand, Railroad av. house 120 North Water [Ont.
 Henderson William T. removed to Port Hope,
 Hendrick Thomas A. removed to Charlotte
 Hendricks Martin, clerk, b. Clifford n. St. Joseph
 Hendrikse Florus, curtain hanger, b. Clifford near St. Joseph
 Hendrikse William C. painter, house Clifford n. St. Joseph [house 139 Saxton
 Hendrix Albert B. bookkeeper, 192 State,
 Hene Herman, cigar manuf. 40 Andrews, house do. [Cypress
 Heney James, overseer, Penitentiary, b. 10
 Heng John V. tailor, house 15 Hope
 Henion Ann, boarding house, 11 Elizabeth
 Henion John B. physician, 165 West av. house do.
 Henion, see Henyon
 Henkel Frank, laborer, house 22 Wilder
 Henkel G. Henry, grocer, Mt. Vernon av. cor. Whitmore park, house do.
 Henkey Mary Ann, widow, house Andrews corner Franklin
 Henkle Leonard, roofing, house 443 Brown
 Henn Joseph, hairdresser, 159 East Main, b. 120 Front
 Henn William, toolmaker, house 11 Maria
 Henneberger George C. saloon, 20 Stone, house do.
 Henneby Patrick, laborer, boards 5 Ely
 Hennekey Abraham, mason, h. 5 Huntington
 Hennekey Abraham jr. mason, house 11 Huntington [house 9 Victoria
 Hennelly John H. laborer, Brown c. Jones,

- Hennemann John, tailor, 79 State, house 85
Smith [Lyell]
- Hennerson Jacob, teamster, 138 Oak, h. 137
- Hennessey Alonzo, shoemaker, b. 96 North
St. Paul
- Hennessey Catharine, widow, h. 27 Troup
- Hennessey Esther, widow, h. Pinnacle av.
near Henrietta avenue
- Hennessey Jeremiah, laborer, house Webster
road near Goodman [27 Lancaster]
- Hennessey John, tinsmith, 144 E. Main, b.
- Hennessey John, watchman, house 295 Jay
- Hennessey John, cutter, 63 Mill, house 96
North St. Paul
- Hennessey John, cutter, boards 6 King
- Hennessey Martin, coachman, b. 37 North
St. Paul
- Hennessey Martin, shoemaker, house 6 King
- Hennessey Martin G. shoemaker, b. 6 King
- Hennessey Mary, boxmaker, boards Bolivar
near Lyell
- Hennessey Mary, laundress, Osburn House
- Hennessey Michael, boards 6 King
- Hennessey Michael G. painter, 74 Arcade, b.
27 Troup [Lyell]
- Hennessey Patrick, laborer, h. Bolivar near
- Hennessey Thomas, laborer, bds. 68 Cypress
- Hennessey Thomas, overseer, Penitentiary,
boards 10 Cypress [city]
- Hennessey Thomas, removed to New York
- Hennessey William, shoemaker, h. 17 Sanford
- Henning Mary F. seamstress, bds. 1 Grape
- Henrahan Patrick, maltster, Atwater corner
Water, boards 16 Clifford
- Henricus Christina, widow, bds. 97 Hudson
- Henricus Constantine, varnisher, 22 S. St.
Paul, h. 51 Hanover [h. 62 Joiner]
- Henricus C. Louis, finisher, 69 N. St. Paul,
- Henricus Ferdinand, varnisher, 22 South
St. Paul, h. 22 Holland [2 Hanover]
- Henricus F. Charles (*M. Henricus & Son*), b.
- HENRICUS MICHAEL & SON** (*P. Chas.*
Henricus), masons and contractors, 2
Hanover, house do.—*See page 590*
- Henry Hill, conductor, N. Y. C. R. R. h.
51 Weld [Lancaster]
- Henry James (*Quambusch & Henry*), h. 35
- Henry James, moulder, Brown's race near
Furnace, boards 4 Spencer
- Henry James P. clerk, house 99 Reynolds
- Henry Jessie Mrs. fancy goods, 3 Montrose,
house do. [Furnace, h. 3 Montrose]
- Henry John B. foreman, Brown's race near
- Henry John S. car coupler, boards 13 Hill
- Henry Joseph (*Courtney & Henry*), cigar
manuf. 341 State, house 326 do.
- Henry Louis, butcher, boards 12 Adams
- Henry Margaret E. stitcher, boards 4 Spencer
- Henry Mary, widow, boards 290 State
- Henry Mary M. stitcher, boards 4 Spencer
- Henry S. Madison, collector, 36 Arcade, b.
3 South [near Furnace, b. 25 Campbell]
- Henry William M. moulder, Brown's race
- Henry William J. shoemaker, 111 State, b.
Genesee c. Clifton [h. 41 Cherry]
- Hensel Julius (*Huyken & Hensel*), 88 Arcade,
- Hensler Frank, house 226 Jay
- Hensler George, laborer, house 50 Childs
- Hensler John, cartman, h. Moulson n. R. R.
- Hensler Philip, laborer, boards 226 Jay
- Henyon Rachel, widow, b. 37 South Ford
- Henyon Reuben L. driver, at C. B. Hill's,
house 37 South Ford
- Hepburn James, engineer, house 3 Anson pk.
- Hepler Adam, laborer, house 47 Gibbs
- Heppeler John, brewer, 139 N. St. Paul, h.
218 North St. Paul
- Herberd Henry H. baggage express, N. Y.
C. depot, boards 2 South Washington
- Herbert Alexander C. removed to Canan-
daigua
- Herbert Patrick, switchman, house 92 Davis
- Herbert Robert, switchman, boards 92 Davis
- Herbrand John, carpenter, 93 Exchange, h.
9 Zimmer
- Herbst Charles, laborer, house 121 Lyell
- Herbst Frederick, farmer, house Hudson n.
Bernard [Paul, boards 6 Leopold]
- Herbst Frederick G. optician, 179 North St.
- Herbst Henry, tailor, b. Lincoln n. Clifford
- Herbst Ignitz, milkman, b. Hudson near
Bernard [near North]
- Herbst Louis, miller, 35 N. Water, b. Hudson
- Herbst Simon, nurseryman, h. 153 Pinnacle
avenue [Clifford]
- Herbst Theresa, widow, house Lincoln near
- Herchler John, chair bottomer, h. 44 Howell
- Herdle Henry, tanner, 87 N. Water, house 9
Stepheny's park [Mt. Hope avenue]
- Herdt George, silver plater, 3 Canal, bds. 90
- Herdt John, cutter, h. 90 Mt. Hope avenue
- Herendeen Mary G. widow, bds. 16 Glasgow
- Heritan Blanche, teacher, h. 21 Lancaster
- Herle Margaret Mrs. house 100 Chatham
- Herle William A. carpenter, Joiner n. Kelly,
hous 19 Rhine [house 11 Green]
- Herlihy Michael, shoemaker, 91 N. Water,
- Herlihy Patrick, shoemaker, 91 N. Water, b.
Front near Market
- Herman Benjamin, clerk, 140 E. Main, bds.
56 Franklin [Franklin]
- Herman Charles, clerk, 140 E. Main, bds. 56
- Herman Gottlieb, clerk, 80 E. Main, house
88 Kelly [56 Franklin]
- Herman Henry, market, 140 East Main, h.
- Herman James M. street car driver, b. 25 Allen
- Hermance Alexander C. clerk, 22 S. St. Paul,
boards 62 Griffith
- Hermance George S. salesman, 22 S. St.
Paul, boards 62 Griffith [12 Grove]
- Hermance Henry C. clerk, 22 S. St. Paul, b.
- Hermann Ernest, laborer, house Hoelfer near
N. Clinton
- Hermann George, laborer, house 32 Weeger
- Hermann Henry, boards 32 Weeger
- Hermann John, laborer, house 20 Hoelzer
- Hermann John, shoemaker, house 89 Orange
- Hermann Paul, laborer, b. Hudson n. Berlin
- Hermann, see Herrmann
- Hermes Louis, removed to New York city
- Herney Louis, cabinetmaker, 15 N. Water,
boards North av. n. Bay
- Hernig John, baker, house 51 Grape
- Hernig Rose, milliner, b. 51 Grape c. Magne
- Herold Conrad, laborer, house 14 Helena
- Herr George, agent, boards 35 Frank

HENRY C. WISNER,

**WHITE CHINA DINING and TEA SETS,
No. 33 STATE STREET.**

Herr Jacob, mason, house 6 Pryor
 Herr Jacob jr. sawyer, 38 Gorham, b. 6 Pryor
 Herr Nicholas, peddler, house 44 German
 Herrieng Joachim, removed from city
 Herrick James (*Towner & Herrick*), 6 Exchange, boards 51 Spring
 Herrick Mary W. widow, h. 35 Sibley's blk.
 Herring Albert H. mason, house Langham
 Herring Gustav, laborer, boards Langham
 Herring James B. house 171 North Clinton
 Herring John, butcher, boards 97 W. Maple
 Herring Joseph, carpenter, h. 97 W. Maple
 Herring Thomas, farmer, house York corner Champlain
 Herrington Louisa, boards 172 East Main
 Herrmann John K. blacksmith, h. 13 Concord avenue
 Herrmann Mary, grocer, 134 Hudson, h. do.
 Herschell James, miller, Washington Mills, house 157 Brown
 Hershberg Amelia, widow, boards 5 Pryor
 Hert Anna, widow, house 24 Lewis
 Hert Benedict, deceased May 6, 1875
 Hertel Frederick, mason, house 432 Brown
 Hertel Frederick C. harnessmaker, boards 394 Brown [h. 398 Brown
 Hertel J. William, harnessmaker, 4 Sophia,
 Hertel Mary M. seamstress, 432 Brown, b. do.
 Hertel Matthias, mason, house 394 Brown
 Hertel William G. mason, boards 432 Brown
 Hertford John, waiter, boards 131 Meigs
 Herthe John, removed from city
 Hertweck Anthony, stonecutter, h. Bernard near Hudson [opp. Clifton
 Hery Nicholas, moulder, 8 Hill, h. Genesee
 Herzberger Conrad, market, 226 E. Main, house 59 S. Clinton [ton, h. do.
 Herzberger George, market, 59 South Clinton
 Herzberger George, clerk, 226 E. Main, bds. 59 South Clinton [boards do.
 Herzberger Henry, clerk, 59 South Clinton,
 Herzberger Louis, butcher, 226 E. Main, b. 59 South Clinton
 Hesler Catharine, widow, house 106½ E. Main
 Hess Ezra P. engineer, house 216 North
 Hess Frederick, shoemaker, 67 North av. house do.
 Hess George A. removed to Ontario Co.
 Hess Lawrence, stonecutter, 54 Fitzhugh, boards Buchan park
 Hess Lewis, laborer, house 4 Walnut
 Hess Lewis, grinder, house 34 Vienna
 Hess Lewis, clerk, boards 4 Walnut
 Hess Minna, midwife, house 34 Vienna
 Hess Peter, St. Nicholas House, Front cor. Mumford, house do.
 Hess Philip, tailor, bds. St. Nicholas House
 Hess Rosina, widow, house 315 N. St. Paul
HESS SOLOMON F. tobacconist, 7 Exchange, h. 123 Plymouth av. — *See page 566*
 Hessdorffer Francis, removed to Nazareth, Montgomery Co., O.
 Hesse Adam, tailor, house 17 Wait
 Hesselink Aaron J. laborer, h. Sibley corner Bates
 Hesselink Henry, teamster, b. Sibley c. Bates
 Hesslinger Joseph (*Hesslinger & Stallknecht*), house 228 West Main

Hesslinger & Stallknecht (*J. Hesslinger and A. Stallknecht*), grocers, 226 W. Main
 Hetherington John, hostler, Osburn House, boards do.
 Hetherington Mary, domestic, Osburn House
 Hettel Anton, turner, 123 Mill, h. 39 Maple
 Hettell Sophia, widow, house 193 Scio
 Hetterich John J. tailor, boards 94 Scio
 Hettig Benedict, cabinetmaker, h. 12 Nassau
 Hettig Florian, carpenter, house 35 Baden
 Hettig Florian A. tailor, house 40 Vienna
 Hettig Louis, packer, house 12 Nassau
 Hettig Louisa Mrs. dressmaker, 12 Nassau, house do.
 Hettiger Catharine, widow, house 44 Front
 Hettiger Patrick, laborer, 54 Fitzhugh, h. 1 Green
 Hettiger Caroline, widow, house 25 Leopold
 Hettiger Elizabeth, widow, b. 11 St. Joseph
 Hettiger John, laborer, boards 25 Leopold
 Hetterich Lawrence, tailor, house 94 Scio
 Hettrich John, deceased May, 1875
 Hettrich Margaret, widow, house 181 North
 Hetzel Albert, bartender, 105 E. Main, house 1 Weld [105 E. Main
 Hetzel Charles F. clerk, 94 West Main, bds.
 Hetzel Charles F. grocer, 156 North av. h. do.
 Hetzel Christian, clerk, 156 North av. b. do.
 Hetzel Ferdinand, gasfitter, 84 E. Main, h. 23 Manhattan
 Hetzel Henry, saloon, 46 Kent, house do.
 Hetzel Henry J. clerk, 36 Powers' buildings, boards 156 North avenue
 Hetzel John C. saloon, 105 E. Main, h. do.
 Hetzel John M. clerk, 156 North av. b. do.
 Hetzel John P. saloon, 94 W. Main, bds. 105 East Main
 Hetzel Matthias, boards 105 East Main
 Hetzel William, grocer, 116 Mt. Hope av. house do.
 Hetzel Wm. L. clerk, 105 E. Main, bds. do.
 Hetzk John, laborer, house 5 Holland
 Hetzler Carl, joiner, boards Jay near Ames
 Hetzler Charles, tailor, house 30 Henry
 Hetzler Conrad, tailor, b. Grape c. Romeyn
 Hetzler Frank, laborer, b. Whitney n. Lyell
 Hetzler George A. tailor, 65 St. Joseph, h. do.
 Hetzler Hannah, widow, house Jay n. Ames
 Hetzler Henry, deceased July, 1875
 Hetzler Henry F. moulder, 20 Court, boards Grape corner Romeyn
 Hetzler John, tailor, Grape c. Romeyn, h. do.
 Hetzler John A. clerk, 73 N. Clinton, bds. 19 Hamburg
 Hetzler J. George, tailor, 75 Chatham, h. do.
 Hetzler Kuhne, tailoress, bds. 19 Hamburg
 Hetzler Valentine, tailor, N. Clinton c. Atwater, house 19 Hamburg
 Heueneck Henry G. laborer, h. Leavenworth alley cor. Champion
 Heuer Charles, pianomaker, 4 Hill, house 141 St. Joseph
 Heuer Frederick A. cabinetmaker, Jay cor. Erie canal, house 28 Kelly
 Heuer Henry C. cabinetmaker, Jay c. Erie canal, b. 28 Kelly
 Heuer Herman J. C. bootreer, 55 Mill, house 41 Campbell

Heughes Frederick L. bookkeeper, 106 South St. Paul, b. 2 Elm

HUGHES JOHN C. & CO. (*B. Sherry*), boot and shoe dies, Mill c. Platt, house 198 N. St. Paul.—*See page 662*

Heughes Mary C. widow, b. 198 N. St. Paul

Heumann Bernhard, clothier, h. 86 Pinnacle avenue [218 do.

Heurich John, moulder, 187 W. Main, bds.

Heusler John G. brewer, foot of Cliff, h. do.

Heusler Lawrence, laborer, h. Ulm n. Bay

Heusner Charles F. clerk, N. Y. C. R. R. freight house, Platt c. Kent, b. 3 Madison

Heusner Louis D. clerk, N. Y. C. R. R. ticket office, boards 3 Madison

Heusner Mary Mrs. house 3 Madison

Heveron John, mason, boards 10 Shamrock

Heveron Margaret, widow, h. 10 Shamrock

Heveron Thomas, removed from city

Hewer Alfred C. carriagemaker, 194 West Main, boards 27 Lyell

Hewer Frances, widow, house 27 Lyell

Hewer Henry W. butcher, 329 State, boards 27 Lyell

Hewes Charles A. removed to Virginia

Hewes Jenny M. nurse, boards 75 Court

Hewitt Ann, widow, boards 9 Arnold park

Hewitt Elнора, portrait painter, b. 42½ Lyell

HEWITT FRANK L. druggist and news dealer, 44 South av. h. do.—*See page 570*

Hewitt Henry H. student, Roch. Theological Seminary, boards Trevor Hall

HEWITT HIRAM H. plow manufacturer, Platt c. State, house 32 Platt.—*See p. 673*

Hewitt Libbie, dressmaker, 131 Caledonia avenue, boards do. [18 Lake avenue

Hewitt Samuel E. toolmaker, 120 Mill, house

Hewitt Violet M. widow, house 91 Court

Hewlitt Julia, widow, house 9 South avenue

Hewlitt Robert, house 130 Caledonia avenue

Hewlitt Robert jr. blacksmith, boards 130 Caledonia avenue

HEY LEVI, rag and paper stock dealer and tinsmith, 215 and 244 State, house 11 Jay.—*See page 670*

Hey Moses, machinist, h. Childs n. W. Maple

Heydler Ernest C. pastor, St. John's Lutheran church, house 173 St. Joseph

Heyer John, carpenter, h. Clifford c. Maria

Heyer Theodore, shoemaker, 79 N. Water, house 21 Flower

Heys Julia A. widow, house 91 S. St. Paul

Heyser Henry C. clergyman, house 60 Hamilton place

Hibbard Almira W. widow, bds. 159 Wilder

Hibbard James W. teamster, 8 Hill, house 5 Railroad alley

Hibbard Jennie, telegrapher, b. 33 Culver pk.

Hibbard Lucy R. widow, house 161 Wilder

Hibbard Sarah Mrs. boards 134 East avenue

HIBBARD SARAH A. physician and druggist, 134 East av. h. do.—*See page 569*

Hibbard, see Hebard and Hebbard

Hichborn Henry C. clerk, 13 E. Main, b. do.

Hichborn Robert H. (*Hichborn & Co.*), bds. Wood's Hotel

HICHBORN & CO. (*R. H. Hichborn*), dry goods, 13 E. Main.—*See page 546*

Hickey Anna E. telegraph operator, bds. 36 Platt

Hickey Daniel, teamster, h. 123 Champlain

Hickey Deborah, packer, 182 State, house 10 Union alley

Hickey Edwin T. (*Schulz & Hickey*), r. 46 South avenue, boards Sanford

Hickey Jeremiah, clothier, 90 State, house 59 Pinnacle avenue

Hickey John, laborer, house 36 Cady

Hickey John F. cigarmaker, 138 W. Main, boards 13 Caroline

Hickey Levina, widow, house 13 Caroline

Hickey Michael, shoemaker, 55 Mill, house Frost avenue near Summer

Hickey Thomas, laborer, bds. 218 W. Main

Hickman Abram, teamster, boards 2 East

Hickman George, laborer, house 52 Gregory

Hickmott Helen F. widow, h. 11 Gardiner pk.

Hickok Henry, farmer, h. Norton n. Carter

Hicks Albert R. removed to Hornellsville

Hicks Clinton C. agent, 6 Corinthian hall bldg. b. Rowley c. Monroe avenue

Hicks Corydon C. agent, Cincinnati Safes, 6 Corinthian hall bldg. house 10 Rowley

Hicks Delbert P. varnisher, Jay corner Erie canal, boards 12 Dean

Hicks DeWitt C. violinmaker, h. 44 South av.

Hicks Edwin O. shoemaker, b. 4 Sibley's bl.

Hicks Elias, salesman, house 213 Monroe av.

Hicks Elon D. bracket manuf. Jay cor. Erie canal, house 74 Jay

Hicks Elsie, widow, house 23 Gardiner park

Hicks Fayette G. salesman, house New York near Frances

Hicks Joseph W. foreman, State c. Centre, h. 9½ Jay [B. n. Conkey av.

Hicks Philip (*Hicks & Schmitt*), house avenue

Hicks Sarah, widow, house 4 Sibley's block

Hicks Sophia Mrs. house 12 Dean

Hicks Sylvester B. salesman, h. 16 Park av.

Hicks Thomas, miller, Whitney Mills, house 15 Montrose

Hicks Thomas, boardinghouse, 25 Allen, h. do.

Hicks Thomas G. laborer, boards 25 Allen

Hicks William J. stonecutter, bds. avenue B. near Conkey avenue

Hicks & Schmitt (*P. Hicks and L. Schmitt*), blacksmiths, 5 Spring

Hickson Elliott, gilder, 110 Front, b. 130 Jones

Hickson George H. cigarmaker, boards 96 Tremont [c. Lowell

Hickson Margaret, tailoress, boards Martin

Hickson Robert, foreman, 110 Front, house 30 Gorham [house 27 Martin

Hieb Henry, hairdresser, 14 Powers' bldgs.

Hieronimo Sister, Rochester Home of Industry, 136 South St. Paul, house do.

Higbie Frank P. bookkeeper, 31 Arcade, bds. 36 Fitzhugh

Higbie Horace A. (*Williamson & Higbie*), 62 West Main, boards 36 Fitzhugh

Higbie Silas, boards 126 Monroe avenue

Higbie William H. (*Rose, Higbie & Haskin*), 66 West Main, house 4 Greig

Higgin John, cutter, boards 35 Frank

Higginbotham Louis, engraver, 20 W. Main boards Reed House

Higgins Alvira, widow, house 232 Exchange
 Higgins Ann, domestic, b. 54 Jay [h. do.
 Higgins Catharine, grocer, 229 Plymouth av.
 Higgins Cornelius H. deceased March, 1876
 Higgins Ezra M. (*E. F. Hyde & Co.*), 64 East
 Main, boards 232 Exchange
 Higgins Gregory, quarryman, house Mag-
 nolia near Plymouth avenue
 Higgins Henry, waiter, Osburn House
 Higgins Henry W. coachman, 32 Glasgow,
 house Tremont corner Reynolds
 Higgins John J. salesman, North avenue c.
 Webster, boards 4 Comfort [Genesee
 Higgins Martin, quarryman, house Cottage n.
 Higgins Mary J. widow, h. rear Stone near
 Allen's alley [13 McDonald av.
 Higgins Michael, maltster, 65 N. Water, h.
 Higgins Rachel, widow, boards 27 Comfort
 Higgins Washington H. house 9 Reynolds
 Higgins William, wagon maker, Champion
 cor. Leavenworth alley, house 13 Bloss
 Higgins William H. gas fitter, Gas Works, h.
 35 Davis [10 Stillson
 Higley Charles E. salesman, 73 E. Main, bds.
 Higley David, carpenter, house 22½ Scio
 Higley Oralda E. watchmaker, Court corner
 Stone, boards 209 Monroe avenue
 Higon John, laborer, 138 Mill
 Hilberg Bernhart, hostler, 47 S. St. Paul, b.
 24 Hamilton place [h. 48 Chatham
 Hilbert Charles, salesman, 52 South St. Paul,
 Hilbert George, flour and feed, North avenue
 n. Caspar, house Jennings n. North av.
 Hilbert Henry, mason, boards 6 Henry
 Hilbert John, sashmaker, house 56 Munger
 Hilbert John F. collector, house 84 Meigs
 Hilbert Margaret, widow, boards 84 Meigs
 Hilbert Valentine, mason, house 6 Henry
 Hildebrand Louis, varnisher, 184 State, h.
 10 Bay
 Hildebrand Charles, laborer, house 53 Tyler
 Hildenbrand Augustus, saloon, 168 North,
 house do.
 Hilderbrandt Charlotte Mrs. house 17 Childs
 Hildreth Horace, laborer, house r. 13 Green
 Hildreth Samuel M. & Co. (*Wm. Hildreth*),
 proprs. Brackett House, Mill, house do.
 Hildreth William (*S. M. Hildreth & Co.*), bds.
 Brackett House [North Clinton
 Hile Louis N. clerk, 15 E. Main, boards 71
 Hilfiker John, bakery, 43 Monroe av. h. do.
 Hilfinger Christian, stove moulder, 8 Hill,
 house 105 Scio
 Hilfinger Geo. E. stove moulder, 8 Hill, bds.
 105 Scio [boards Thomas
 Hilgendorf Henry, packer, 141 N. Water,
 Hilgenreiner Edmund, optician, 179 N. St.
 Paul, house 17 Galusha
 Hill Albert D. tinsmith, 15 East Main, house
 rear 36 Griffith
 Hill Alexander R. & Son (*H. W. Hill*), well
 drillers, h. Summer corner Champlain
 Hill Ann, widow, house 15 Clinton place
 Hill Benjamin H. (*Hill & French*), house 7
 Trowbridge

HILL CHARLES B. merchant miller, S.
 Water near E. Main, h. 43 Plymouth av.
 —See page 552

Hill Charles F. moulder, rear 204 State, house
 Smith corner Kent
 Hill Charles H. salesman, bds. 12 Tracy pk.
 Hill Charles J., South Water near East Main,
 house 10 Prince
 Hill David L. student, University of Roches-
 ter, boards 110 University avenue
 Hill Edward laborer, boards 42 Greig
 Hill Edward A. shoemaker, 87 North Water,
 boards 97½ East Main
 Hill Francis C. laborer, house 22 Brown's al.
 Hill George, blacksmith, house Schanck av.
 near Goodman
 Hill Horace W. (*A. R. Hill & Son*), house
 Summer corner Champlain
 Hill John H. hardware, 29 West Main, house
 49 East avenue
 Hill Kate S. saleswoman, bds. 12 Tracy pk.
 Hill Martha Miss, baker, boards 117 Adams
 Hill Mary A. widow, house 32 Bolivar
 Hill Matilda, widow, house 12 Tracy park
 Hill Rowland, boards 58 Frank
 Hill Weltha B. boards 10 Prince
 Hill William, carpenter, house Bartlett near
 Reynolds [pany, 4 Jackson, h. r. do.
 Hill William, agent, Fulton Towing Com-
 Hill William W. clerk, 79 E. Main, house 56
 Alexander

HILL & FRENCH (*B. H. Hill and O. C.
 French*), coal dealers, 33 West avenue.—
 See page 601

Hillangas Adam, laborer, house 57 Kirk
 Hillangas Adam jr. packer, 33 State, house
 57 Kirk
 Hillard William, saloon, 234 State, house do.
 Hiller Jacob, fireman, Oak cor. Smith, house
 93 Orange
 Hiller Mary, domestic, bds. 123 East avenue
 Hille James, laborer, house 1 Allen's alley
 Hillis Isaac, painter, house 41 Davis
 Hillman Emily R. dressmaker, b. 19 Fulton
 avenue [Frank
 Hillman Frank W. clerk, 123 State, bds. 12
 Hillock Thomas, tallyman, Platt cor. Kent,
 house 3 Campbell
 Hills Abigail Mrs. house 83 Alexander
 Hills Ammi, house 57 Prospect [n. Norton
 Hills Dan'l H. comb maker, house Hudson
 Hills Edmund, coal, 66 Hudson, house 83 do.
 Hills Frank A. carrier, Post Office, boards
 82 West avenue [67 Plymouth av.
 Hills Isaac, lawyer, 16 Powers' bldgs. house
 Hills Jane M. widow, boards 10 Woodbury
 Hills Jeremiah M. comb maker, h. Hudson
 near Norton
 Hills Reuben, milkman, house 2 Woodbury
 Hills Winslow H. clerk, boards 83 Hudson
 Hilsdorf William, blacksmith, 159 State, h.
 34 Sellinger [h. 106 University av.
 Hilton H. Porter, bridgebuilder, Leighton av.
 Hilton Jacob, clerk, house Smith cor. Jones
 Hilton John E. clerk, house 63 Lyell
 Hilt Charles W. cotton carder, Rochester
 cotton mill, house 131 Wilder
 Hilt Frank M. laborer, boards 17 Jones
 Hilt Geo. S. machinist, 6 Hill, b. 17 Jones
 Hilt John H. carder, Rochester Cotton Mill,
 house rear 4 Pitt

Hilts Thomas E. overseer, Rochester Cotton Mill, foot Centre, house 17 Jones
 Himenez Charles, bookkeeper, b. 49 Kirk
 Himmel Augustus, house 113 North Clinton
 Himmel Jane, flower painter, b. 113 N. Clinton
 Himmel Joseph, fireman, h. Miller's alley n. Atwater
 Himmel William, engineer, N, Y. C. R. R. boards 113 North Clinton
 Himmelsbach Frances, widow, house. East Main corner Scio
 Himmelsbach Henry, cigar maker, boards E. Main corner Scio
 Himmer George, engineer, 184 State, h. 47 Oakman
 Hinchey Franklin, tax agent, N. Y. C. R. R. Centre cor. Mill, house at Gates
 Hinds James A. miller, Washington Mills, Brown's race, c. Factory, h. 82 Lake av.
 Hinds Sarah A. removed to Greece
 Hindson William J. printer, bds. 17 Gregory
 Hine Maria E, widow, house 128 S. St. Paul
 Hine Noble J. deceased June, 1875
 Hinemann Frederick, removed to Connecticut
 Hines Adolphus, boards 62 Clifton
 Hines Alfred H. carriage trimmer, 3 Canal, boards Clifton opp. St. Clair
 Hines Anna, dressmaker, boards 7 Vought
 Hines Charles, hackman, 4 S. Clinton, house 17 Joiner [h. 62 Clifton
 Hines Nelson R. carriage trimmer, 3 Canal,
 Hinett James, laborer, Vacuum Oil Works, boards Mansion n. Flint
 Hingston Samuel, boatbuilder, Exchange st. slip, house 6 Eagle [bds. do.
 Hinkley D. Eugene, watchmaker, 37 Stone,
 Hinkley Emma, boards East avenue corner Alexander [Bay
 Hinger Lawrence, tailor, h. Goodman near
 Hinman Clara, widow, house 5 Briggs' place
 Hinman Clara Miss, clerk, bds. 5 Briggs' pl.
 Hinman Frank T. miller, Crescent Mills, b. 21 North St. Paul [Briggs' pl.
 Hinman Mary, clerk, 7 East Main, boards 5
 Hinman Mary W. teacher, Concord School, No. 18, boards 14 S. Clinton
HINMAN PORTUS M. stoves, tinware, &c. 16 S. St. Paul, h. 20 Stone.—See page 627
 Hipp George T. carpenter, house Carter near North avenue [102 N. Clinton
 Hirsch Adolph, clerk, 164 W. Main, boards
 Hirsch Frederick, machinist, Mill c. Factory, house Grape cor. Campbell
 Hirsch George, saloon, N. Clinton c. Atwater. house do. [h. Goodman
 Hirsch Roman, shoemaker, 79 North Water,
 Hirschfield Benjamin, peddler, h. 25 Gregory
 Hirschfield Moses, student, University Roch. boards 37 Howell [b. 60½ Andrews
 Hirschfield Marcus, student, 18 Powers' bldgs.
 Hiser George, sawyer, h. Straub al. n. Rowe
 Hiser see Heiser
 Hisom Thomas, peddler, house 9 Edmonds
 Histon Catharine, widow, boards 7 Syke
 Histon Patrick, laborer, house 7 Syke
 Histon Thomas, fireman, house 14 Lime
 Hitchcock Delia, widow, h. 54 Caledonia av.

Hitchcock Frederick A. lawyer, 14 State, b. 41 South Ford
 Hitchcock Gilbert S. salesman, 53 E. Main, boards 44 Cypress [54 Caledonia av.
 Hitchcock James, moulder, 150 N. Water, b.
 Hitchcock Joseph, carpenter, 65 Adams, h. do.
 Hitchcock Norman P. tinsmith, 66 E. Main, house 44 Cypress
 Hitchcock Robert H. foundryman, 150 N. Water, boards 54 Caledonia avenue
 Hitchens William, laborer, house Wentworth corner New York
 Hitzel Charles, butcher, 115 Lyell, bds. do.
 Hitzel Jacob, butcher, Jay c. Oak, bds. do.
 Hitzel Philip H. market, Jay cor. Oak, h. do.
 Hitzfeld Elizabeth, widow, boards 78 Martin
 Hitzfeld Joseph, mason, h. Childs n. Smith
 Hitzler John, deceased June, 1875
 Hitzler Mary F. saloon, 52 Mill, house do.
 Hixson Alfred, shoemaker, 87 N. Water, b. 96½ Tremont
 Hixson Fannie, widow, house 9 Stone
 Hixson George H. cigar maker, 6 N. Water, boards 96 Tremont
 Hixson Samuel J. cartman, h. 70 S. Union
 Hixson see Hickson
 Hoag George H. bartender, 86 Mill, bds. do.
 Hoag Hamilton M. clerk, house 164 State
 Hoagland Fred. C. watch repairer, 35 W. Main, house 6 Clarissa
 Hoare George R. clerk, 83 State, b. 77 Allen
 Hoare John R. 126 State, house 77 Allen
 Hoban Maria, widow, house 137 Frank
 Hoban William K. printer, 82 West Main, h. 193 State
 Hobart Anson H. tucker, house 43 Platt
 Hobbie Caleb K. farmer, boards Culver cor. Schanck avenue
 Hobbie Jane Miss, boards 63 Delevan
 Hobbis Lucius H. produce, house 137 Adams
 Hobbirker Joseph H. (*Hobirker & Gesell*), h. 18 King. [*Gesell*], market 104 West av.
 Hobbirker & Gesell (*J. H. Hobbirker and Geo.*)
 Hobson John, removed to Whitby
 Hoch Albert, optician, 179 N. St. Paul, bds. 17 Saxe
 Hoch Charles, stonemason, house 197 Scio
 Hoch John, optician, 179 N. St. Paul, boards Allen corner King [alley
 Hochhaimer Joseph, planemaker, h. 116 Kent
 Hochbruchner Michael, stonemason, 22 W. avenue, boards 102 Front
 Hochstetter Geo. G. drover, h. 36 Chatham
 Hockenyoys Louis, tailor, 64 Kelly, h. 140 St. Joseph
 Hoctor John, salesman, 80 State, h. 82 Kent
 Hoctor Patrick, policeman, City Hall, house 71 Scio
 Hodecker Frederick, Supt. Rochester Brewing Company, house 1 Cliff
HODECKER PHILIP, tight cooper, 5 Thompson, house do.—See page 678
 Hoder Isaac, teamster, r. S. St. Paul, opp. Griffith
 Hodge John, mason, house 66 Monroe av.
 Hodge Robert, student, b. 39 N. St. Paul
 Hodges Elliott, flour packer. b. 10 Sherman
 Hodges Merica Miss, house 126 Fitzhugh

HENRY C. WISNER,

PARLIAM BUSTS AND FIGURES,
 No. 33 STATE STREET.

- Hodges Willard, farmer, h. r. Pinnacle av. beyond city line
- Hodgman Asa, removed to Canada
- Hodgson James S. shoemaker, 91 N. Water, house Hoefler near North Clinton
- Hodgson John, shoemaker, house 23 Ward
- Hodgson John W. jeweler, 16 Elwood block, boards 23 Ward
- Hodgson Matthew S. shoemaker, 55 Mill, b. 23 Ward
- Hodgson Thomas C. solecutter, 55 Mill, bds. 125 Adams [Conkey av.
- Hoefen Anna, tailoress, boards Clifford cor.
- Hoefen Evelyn, tailoress, boards Clifford cor. Conkey avenue
- Hoefen Ignatz, tailor, 5 Kelly, house do.
- Hoefen Leopold, clothing, 203 N. Clinton, house do. [Conkey av.
- Hoefen Michael, laborer, house Clifford cor.
- Hoefler Charles B. hatter, 12 E. Main, house Martin cor. Sheridan park [b. do.
- Hoefler Fred. W. saloon, 48 South St. Paul.
- Hoelt Albert E. clerk, 51 State, bds. 12 N. Clinton [h. do.
- Hoehn George jr. grocer, 152 North avenue,
- Hoehn Jacob, blacksmith, house North av. near Bay [North av.
- Hoehn Jacob 2d, blacksmith, house 151½
- Hoehrlen Adolph, coffin maker, boards 32 Franklin [av.
- Hoekstra Annas J. carpenter, house 3 Fulton
- Hoekstra Egbert, compositor, 3 West Main, house 174 Jay
- Hoekstra Jacob A. editor, house 27 Frank
- Hoekstra Sietske, widow, bds. 3 Fulton av.
- Hoekstra Sietske, teacher, Genesee School, No. 4, boards 3 Fulton avenue
- Hoellrigl Anselm A. cutter, 24 State, house 22 Almira
- Hoelzer Adam, tool forger, house 52 Martin
- Hoenicka George, laborer, 3 Elizabeth, house 87 Scio [do.
- Hoenner Geo. J. framemaker, 8 Allen, b. 71
- Hoenner Lorence, pictures, house 71 Allen
- Hoenner Nicholas, machinist, bds. 71 Allen
- Hoeret Albert L. M. hairdresser, 88 E. Main, house 31 Chatham [avenue
- Hoeret Augustus L. hairdresser, b. 85 North
- Hoeret Elizabeth, widow, house 70 Nassau
- Hoeret Julia, midwife, house 85 North av.
- Hoeret Leonard, deceased May, 1875
- Hoernline C. William, turner, 136 Mill, h. 118 W. Maple [St. Joseph
- Hof Ernest, shoemaker, house r. Huron near Hof Louis, grocer, 392 Brown, house do.
- Hof Louis P. clerk, 392 Brown, bds. do.
- Hof Michael, basketmaker, h. 17½ Hawkins
- Hof William, mason, boards rear Huron near St. Joseph
- Hof Jacob, laborer, house 26 German
- Hoff Henry, removed to Canandaigua
- Hoff Joseph, tailor, house 97 Hudson
- Hoffman Adolph, bartender, 175 North Clinton, boards do. [147 Lyell
- Hoffman Andrew G. glazier, 7 West Main, h.
- Hoffman Augustine, laborer, house Bond near Grand
- Hoffman Caroline, tailoress, house r. 4 Pitt
- Hoffman Catharine, widow, h. 1 Peach alley
- Hoffman Charles, laborer, h. 1 West Orange
- Hoffman Charles J. foreman, rear 54 North, house 36 Grape [Ulm n. Bay
- Hoffman Edward, currier, 25 N. Water, h.
- Hoffman Edward A. clerk, bds. 40 Atwater
- Hoffman Edward S. carpenter, 301 State, house do. [North av.
- Hoffman Frederick, stonecutter, house 91
- Hoffman George, carriage painter, 3 Canal, boards 80 Atkinson
- Hoffman Henry, carriage maker, 35 South St. Paul, house 35 Court [bds. 35 Court
- Hoffman Henry E. bookkeeper, 72 E. Main,
- Hoffman John, show case maker, Exchange cor. Court, house 21 Ontario
- Hoffman John, carpenter, house 60 Hollister
- Hoffman John A. toolmaker, h. 40 North av.
- Hoffman John C. hairdresser, 1 Corinthian Hall bldg. boards 121 Alexander
- Hoffman Joseph (*Hoffman & Mayer*), house 40 Atwater [h. 10 Hanover
- Hoffman Joseph, sausage maker, 34 Front,
- Hoffman Joseph, laborer, N. Y. C. R. depot, house 78 Ames [110 South av.
- Hoffman Joseph, cabinet maker, 2 Hill, h.
- Hoffman Lawrence, brewer, 139 North St. Paul, house 175 do.
- Hoffman Margaret, widow, house 19 Holland
- Hoffman Mary A. widow, house 141 Lyell
- Hoffman Peter, carpenter, house 316 North Clinton
- Hoffman Sarah, widow, house 35 Joiner
- Hoffman Valentine, varnisher, 184 State, h. Hebard near German

HOFFMAN & MAYER (*Joseph Hoffman and John Mayer*), undertakers, 10 Allen, and 37 Andrews.—See page 568

- Hoffmeyer Louis, laborer, h. 213 Pinnacle av.
- Hofheinz Jacob (*Klein & Hofheinz*), 6 Exchange place, boards 139 N. St. Paul
- Hofheinz Rudolf, saddlemaker, 1 Walbridge's block, boards 7 Mortimer
- Hofman Christian, carpenter, b. 37 Ontario
- Hofman George, laborer, house 37 Ontario
- Hofman John, varnisher, house Jennings
- Hofman John, wagonmaker, house 94 North avenue [Mumford, b. 24 Scramton
- Hofmeister Adolph, carriage trimmer, 31
- Hofmeister Emil, compositor, 18 N. St. Paul, house 2 Hollister [Romeyn n. Wilder
- Hofschneider Joseph, cutter, 72 Mill, house
- Hofschneider Leopold, pastor, Holy Family Church, house do. [St. Joseph
- Hofste Christian, machinist, 8 Hill, house 157
- Hogan Amanda, saloon, 96 Exchange, h. do.
- Hogan Ann, widow, house Kent al. n. Smith
- Hogan Bridget, domestic, boards 20 West
- Hogan Bridget C. seamstress, h. 12 Evergreen
- Hogan Charles, machinist, 138 Mill
- Hogan Dennis, stonecutter, 54 Fitzhugh, b. 62 Exchange [boards do.
- Hogan Edward, coachman, 88 Fitzhugh,
- Hogan Ellen, house 4 Foehner
- Hogan Honora Miss, boards 6 Shamrock
- Hogan James, switchman, house 3 Shamrock
- Hogan James E. collector, gas works, boards 84 Hudson

- Hogan James F. polisher, 136 Mill, boards 40 Grape
 Hogan James F. tinsmith, 122 State, boards 6 Shamrock
 Hogan John, laborer, house 84 Hudson
 Hogan John, laborer, house 29 Brown's alley
 Hogan John F. clerk, 73 E. Main, boards 84 Hudson
 Hogan Libbie, forewoman, House of Refuge, bds. 304 State
 Hogan Margaret, clerk, boards 12 Evergreen
 Hogan Martin, blacksmith, house 128 State
 Hogan Mary, widow, house 6 Shamrock
 Hogan Mary, servant, Osburn House
 Hogan Mary Ann, dressmaker, h. 40 Grape
 Hogan Mary C. teacher, Oakman School, No. 20, boards 3 Shamrock
 Hogan Michael, laborer, house 337 State
 Hogan O. John, laborer, house 1 Woodbury
 Hogan Patrick, mason, house 20 West
 Hogan Patrick, house 15 Ontario
 Hogan Sarah, milliner, boards 12 Evergreen
 Hogan Thomas, machinist, 124 Mill, boards 40 Grape [84 Hudson
 Hogan Thomas, clerk, 73 E. Main, boards
 Hogan William, removed to Albany
 Hoge Charles, laborer, h. 32 Scrantom cor. Hawkins
 Hogeboom Peter, carpenter, Paper Mill, h. 4 Clarkson [alley
 Hogeboom William, paper maker, h. 1 Straub
 Hogestien Anthony T. finisher, house North Clinton n. Vernon pk.
 Hogestyn Bartel, packer, 48 Front, house 411 North Clinton [n. Norton
 Hogestyn Thos. Mrs. widow, b. N. Clinton
HOGLE FRANK M. concrete roofer, 39 H Tyler, house do.—See page 642
 Hoh Benedict, laborer, house 47 Childs
 Hohenstein John, saloon, Bank court, Exchange place, house 19 Atwater
 Hohm Anthony, deceased Sept. 1875
 Hohm Joseph, clerk, house 24 Goodman
 Hohm Mary widow, boards 24 Goodman
 Hohman Isadore, driver, boards 107 Meigs
 Hohman Richard, tailor, 84 Chatham, b. do.
 Hohnan Victor, shoemaker, 6 West avenue, boards 139 Pinnacle avenue
 Hohmann Ferdinand, cabinet maker, 184 State, house 25 Rauber [Sanford
 Hohmann Henry, sausage maker, boards 50
 Hohmann John, teamster, house Mt. Vernon avenue near Whitmore park
 Holahan James, boards 15 Davis
 Holahan John, plumber, 63 Exchange, house Shamrock n. Ward
 Holahan Michael, laborer, Citizens' Gas Works, North St. Paul, h. 61 Davis
 Holahan Michael, jr. conductor, b. 61 Davis
 Holahan Patrick, laborer, boards 61 Davis
 Holborn Henry, blacksmith, h. 40 Sellinger
 Holborn John, blacksmith, b. 40 Sellinger
 Holborn Reinhardt, boards 40 Sellinger
 Holbrook Fred. C. clerk, bds. East av. near Culver [Culver
 Holbrook Daniel H. agent, house East av. n.
 Holcom Alonzo, farmer, b. 37 Mt. Hope av.
 Holdeker Jacob, removed to Henrietta
 Holden Caleb, stonecutter, 54 Fitzhugh, bds. 96 South St. Paul [16 Caledonia av
 Holden Curtis J. clerk, 159 West Main, bds.
 Holden Edward, laborer, house 185 Exchange
 Holden Edward jr. shoemaker, 83 N. Water, boards 185 Exchange
 Holden Henry, deceased 1876
 Holden John H. laborer, Citizens' Gas W'orks, boards 16 Caledonia avenue
 Holden Levi, laborer, house 9 West
 Holdfender Fred. laborer, house 48 Hoeltzer
 Holdridge Hiram, builder, house 7 Charlotte
 Holdridge Phila B. widow, bds. 82 Clifton
 Holihan John, plumber, house 2 Shamrock
 Holihan William, cigarmaker, 3 Eagle, bds. 2 Shamrock
 Holl John, carpenter, 14 St. Joseph, house 2 Henry [Jones, h. 12 Catharine
 Holl Valentine, blacksmith, Brown corner
 Holland Arthur, tailor, house 235½ E. Main
 Holland Charles, stage carpenter, Rochester Opera House, bds. 235½ East Main
 Holland Charles W. bookkeeper, 72 State, boards 111 Mount Hope avenue
 Holland James, laborer, house Field n. Pinnacle avenue [fuge
 Hollenbeck Anna M. teacher, House of Refuge
 Hollenbeck Hubert R. photographer, 18 West Main, house 61 Broadway
 Holleran Michael, laborer, h. Pinnacle av. near Henrietta avenue [n. Phelps av.
 Holleran Patrick, hackman, h. Backus av.
 Holliday George G. cooper, b. r. 88 Adams
 Holliday John H. machinist, Mill cor. Platt, boards 17 Troup
 Holliday Richard, confectioner, boards 36½ South St. Paul
 Holliday Sarah Mrs. house 17 West Troup
 Holliday William G. machinist, 136 Mill, house 54 Tremont
 Holliger Rudolph, tailor, house 2 Philander
 Hollihan Timothy, laborer, house 59 Adams
 Holling Albert, house 36 Campbell
 Holling John, tinsmith, 90 E. Main, house 31 Bolivar [Ont.
 Hollins George, removed to St. Catherines,
 Hollis Malcomb S. machinist, b. 52 South av.
 Hollister Emmet H. Mrs. (Hollister & Co.), house 63 Plymouth avenue
 Hollister George C. (Hollister & Co.), 102 Exchange, boards 63 Plymouth avenue
 Hollister Granger A. (Hollister & Co.), 102 Exchange, boards 63 Plymouth avenue
 Hollister Henry K. clerk, 17 State, boards 5 North Washington
 Hollister Monroe M. 102 Exchange, house 13 Glasgow
 Hollister Resina Miss, house 27 Tremont
 Hollister Stephen G. (W. B. Morse & Co.) West av. c. Trowbridge, b. 122 West av.
HOLLISTER & CO. (Mrs E. H. Hollister, G. A. and G. C. Hollister), lumber and planing mill, 102 Exchange.—See page 656
 Holloran see Halloran and Holleran
 Holloway Elmor, agent, h. 77 North avenue
 Holloway George, superintendent, 10 Corinthian Hall, house 13 Edinburgh

Holloway Isaac (*Holloway & Normington*), 8 West avenue, house at Buffalo
 Holloway Mary F. *Mrs.* boarding house, 34 North Washington, house do.
HOLLOWAY & NORMINGTON (*Isaac Holloway and Mark Normington*), stone yard, 8 West avenue.—*See page 638*
 Holloway Ann, widow, boards 5 Conkey av.
 Holloway Arthur H. expressman, 83 State, h. 5 Conkey avenue
 Holly Robert, removed to Philadelphia, Pa.
 Holman Neely, screw cutter, 123 Mill, boards 21 Orchard
 Holmes Anna, widow, h. Sibley n. Culver
 Holmes Catharine, widow, boards 26 Jones
 Holmes Edgar, real estate, 55 Powers' bldgs, house Livingston place c. Troup
 Holmes Edmund B. teamster, h. 36 Sherman
 Holmes Harriet, widow, boards 95 Clifton
 Holmes James, laborer, house 9 Harrison
 Holmes Jane A. widow, house 35 Sophia
 Holmes John, laborer, boards 31 S. St. Paul
 Holmes John A. conductor, N. Y. C. R. R. house 116 North avenue
 Holmes John F. (*W. F. Holmes & Co.*), 2 Masonic block, house 66 Atkinson
 Holmes Maria B. widow, house Troup near Caledonia avenue
HOLMES W. F. & CO. (*John F. Holmes*), insurance agents, 2 Masonic block.—*See page 510*
 Holmes Wm. F. deceased March 19, 1876
 Holstead Ansel B. boatman, bds. 54 West av.
 Holt Chester, tree agent, h. 94 University av.
 Holt Peter E. removed to Eldora, Iowa
 Holtfoth Charles, laborer, house Monroe av. near Nichols park
 Holthos Fred. laborer, boards Huntington
 Holton Alfred L. whipmaker, 102½ E. Main, house 26 Tappan
 Holton Eliza A. widow, boards 9½ Comfort
 Holtz Abraham, tailor, house 25 Baden
 Holtz Andrew, butcher, house 52 Childs
 Holtz Christopher, tailor, h. 137 W. Maple
 Holtz Ignats, finisher, boards 242 Jay
 Holtz Louis, clothing, house 80 St. Joseph
 Holtz Simon, clothier, house 120 St. Joseph
 Holtz Solomon, tailor, house 29 Vienna
 Holtzman Jacob, boards 32 Weld
 Holtzschuh Peter, stone cutter, Oak c. Smith, house 9 Thomas
 Holyland Lovena, widow, house 30 Scio
 Holzeland John, brewer, 139 N. St. Paul, h. Conkey avenue c. Clifford
 Holzeland Wm. removed from city
 Holzenthaler Ferdinand, laborer, Pinnacle avenue n. Grand, house 70 Gregory
 Holzer Lawrence, ass't pastor St. Joseph's church, 24 Franklin, house do.
 Holzer Michael, laborer, house 35 Lowell
 Holzhuer Christian, laborer, h. Allmeroth n. Henrietta avenue [house 52 Covlin
 Holzinger Frank, machinist, Brown c. Jones,
 Holzschuh Joseph, tailor, boards 16 Rhine
 Holzschuh Peter, stone cutter, h. 9 Thomas
 Holzwarth Andrew, clergyman, h. 40 Meigs
 Holzwarth August, finisher, 38 Gorham, bds. 40 Meigs

Holzwarth Christian, sawyer, 38 Gorham, h. 105 North avenue
 Homan Catharine, widow, bds. 16 Hawkins
 Homan Cora A. domestic, 7 Fitzhugh
 Homan Frank E. pressman, 23 W. Main, b. 27 Hamilton place
 Homan Mary P. stitcher, b. 27 Hamilton pl.
 Homan Nancy M. widow, h. 27 Hamilton pl.
 Homan Sophia G. stitcher, boards 27 Hamilton place
 Homan see Hohman
 Homann Edmund, brick layer, boards Clifford near Conkey av. [Conkey av.
 Homann Richard, peddler, h. Clifford near Home for the Friendless, East av. c. Alexander
 Home of Industry, 124 West Main
 Homeopathic Free Dispensary, 121 W. Main
 Homer Sarah M. widow, b. 14 N. Washington
 Hommel George, cutter, 14 Mumford, house 8 Elizabeth place [b. 8 Elizabeth
 Hommel Geo. jr. machinist, 179 N. St. Paul,
 Hommel Henry, peddler, house 48 Vienna
 Hommel Simeon, peddler, house 67 Hudson
 Hommel Simon, salesman, boards 48 Vienna
 Hondorf Christopher, driver, Roch. Brewing Co. house 13 Cliff
 Hondorf Wm. (*Swikelhard & Hondorf*), 12 Exchange place, boards 104 Lyell
 Hone Alexander B. (*Burke, Fitz Simons, Hone & Co.*), 53 E. Main, h. 27 S. Clinton
 Hone Alexander K. salesman, 53 E. Main, b. 27 South Clinton
 Hone Henry, mason, h. Culver n. Erie canal
 Hobck Florentine, grocer, Frances c. Hunter, house do.
 Hood Harriet L. teacher, b. Frank c. Lorimer
 Hoogenstein Hover, boards 301 St. Joseph
 Hoogenstein Leonard, tanner, 87 N. Water, house 301 St. Joseph
 Hook Albert, optician, house 17 Syke
 Hook Edward K. miller, 112 State, house 8 Manhattan
 Hook Joseph, removed from city
 Hook see Hauck
 Hooker Charles M. (*H. E. Hooker & Bro.*), E. avenue n. Goodman, h. at Brighton
HOOKEER HORACE B. & CO. (*E. Huntington*), nursery, 255 N. St. Paul, house do.—*See page 526*
HOOKEER H. EDWARD & BRO. (*Charles M. Hooker*), nurseries, East av. n. Goodman, house do.—*See front cover*
 Hooker James H. house 118 North avenue
 Hoolehan Patrick, laborer, b. Burns Hotel
 Hoopam Arent W. carpenter, house 24 Kelly
 Hooper Berintha, widow, house 11 William
 Hooper George W. painter, b. 218 W. Main
 Hooper Isaac, laborer, house 218 W. Main
 Hoosac Tunnel line 147 State
 Hoover Martin, saloon, 55 Hudson, house do.
HOP BITTERS CO. 50 Mill.—*See page 596*
 Hope Hospital, Wolcott r. Mt. Hope cemetery
 Hope John, laborer, boards 146 Lewis
 Hopkins Alphonso A., Rural Home publishing Co. 31 Arcade, house 20 Elm
 Hopkins Edward L. trunkmaker, r. 156 Lake avenue, house 66 South av.

A. R. PRITCHARD & LKLY,

GLOVES, CANES, ETC., A LARGE STOCK,
 No. 78 STATE STREET.

Hopkins Elizabeth A. widow, boards 70 Mt. Hope avenue
 Hopkins George C., Rochester Iron Manuf. Co. 33 Mill, boards 70 Plymouth av.
 Hopkins Herman H. clerk, 21 West Main, b. 5 North Washington
 Hopkins Laura C. Miss, city missionary, b. 13 Caledonia avenue
 Hopkins Mary G. house 308 East Main
 Hopkins Robert, clerk, 64 East Main, bds. 87 East avenue
 Hopkins Stephen, salesman, h. 8 Tracy pk.
 Hopkins Thomas G. cartman, h. 45 Baden
 Hoppe Andrew J. cabinetmaker, Hydraulic buildings, house 47 Sellinger
 Hoppe C. F. W. Rev. pastor, Zion's Lutheran church, house 48 University avenue
 Hopper John R. carpenter, bds. 22 Frank
 Hopwood John M. shoe cutter, 55 Mill, house 50 Frost avenue
 Hopwood Robert F. grocer, 165 West Main, house 5 Greenwood avenue
 Hopwood Thomas H. house 126 Lake avenue
 Horan Edward W. tinsmith, bds. 31 S. St. Paul
 Horan James, laborer, house 98 Whitney
 Horan John, switchman, boards 98 Ontario
 Horan Martin, laborer, h. 96 Whitney n. R.R.
 Horan Mary, widow, boards 98 Whitney
 Horan Thomas, laborer, house 34 Lime
 Horcheler Bernard, policeman, City Hall, h. 76 Gregory [Gregory]
 Horcheler Elizabeth, dressmaker, boards 76
 Horcheler Elizabeth, widow, bds. 27 Ward
 Horcheler George H. (*Horcheler & Miles*), h. 24 Comfort
HORCHELER & MILES (*G. H. Horcheler and W. E. Miles*), doors, sash and blind manufs. Aqueduct.—*See page 639*
 Horcher Wm. blacksmith, house 85 Orange
 Horigan Michael, laborer, house 39 Orange
 Horn Charles, laborer, house 7 Herman
 Horn Charles, carpenter, h. 168 N. Clinton
 Horn Frank, tinsmith, 276 Brown, house 39 East Maple
 Horn George, tool forger, house 3 Vienna
 Horn Herman, teamster, 342 State, boards do.
 Horn Jacob, house 9 Weld
 Horn John, laborer, house 112 North avenue
 Horn Mary H. widow, house 8 Chestnut park
 Horn Matthew, blacksmith, bds. 103 Champlain
 Horn Michael, laborer, house 103 Champlain
 Horn William, laborer, house 14 Widman
 Horn William, laborer, house 74 St. Joseph
 Hornaday William T. taxidermist, 4 College avenue, boards 21 Asylum
 Horne Ben. F. shoemaker, 15 Mill, boards York House
 Horne Edwin W. watchmaker, Court cor. Stone, bds. 29 South
 Horner John (*Lockett & Horner*), 193 South St. Paul, house 51 William
 Horner John C. glazier, house 25 Scio
 Horner William H. house 235 East Main
 Hornlein Wm. turner, house 118 W. Maple
 Hornung Rosa, widow, house St. Joseph n. Hayward park

Horsley Jane, widow, boards 62 West avenue
 Horsfall Albert, painter, boards 1134 E. Main
 Horsley Henry, hostler, house 14 Moore alley
 Horst Christopher, laborer, house 45 Gregory
 Horst Henry, blacksmith, Brown cor. Jones, house 41 Frances
 Horton Charles A. clerk, boards 15 Grove
 Horton Charles T. edge tool manuf. North Water near R. R. house 15 Grove
 Horton Elizabeth, widow, b. 1 Anderson av.
 Horton Elizabeth, widow, boards 2 Ambrose
 Horton Jenny, housekeeper, 5 East
 Horton Joseph P. laborer, h. 39 Savannah
 Horton Miner S. ice dealer, bds. Rowe near Erie canal
HORTON PLATT, ice dealer, 136 State, h. Rowe n. Erie canal.—*See page 571*
 Horton Richard, telegraph repairer, bds. 20 Stone
 Horton Samuel, driver, house 20 Stone
 Horton William, carpenter, 3 Sycamore, h. 25 Vick park
 Horton William F. actor, Rochester Opera House, boards 21 South St. Paul
 Horton William H. clerk, 16 Exchange, bds. 25 Vick park [Ninth n. Rowe
 Hosenfeldt August, laborer, lower falls, h.
 Hoskin Joseph, machinist, Court cor. Stone, boards 28 Court
 Hosmer Fanny, widow, boards 98 Pearl
 Hosmer Thomas B. book agent, house 14 Monroe avenue [30 Adams
 Hotchkin George A. civil engineer, boards
 Hotchkin George N. & Sons (*G. A. and F. Hotchkin*), ice, 175 Exchange, h. 30 Adams
 Hotchkin George W. truss manuf. 145 Powers' buildings, house at Albion
 Hotchkin James W. salesman, 100 State, b. 6 Gibbs
 Hotchkiss Arvilla, widow, house 102 Hudson
 Hotchkiss Charles, saloon, 172 State, house 160 do.
 Hotchkiss Cyrus I. deceased March, 1876
 Hotchkiss Frank D. house 16 Prince
 Hotchkiss James L. student, University of Rochester, boards 40 East avenue
 Hotchkiss John (*Hotchkiss & Nagle*), house 174 State
 Hotchkiss Levi, real estate, house 40 East av.
 Hotchkiss Miles, b. Straub al. n. McCracken
 Hotchkiss & Nagle (*J. Hotchkiss and A. Nagle*), saloon, 174 State
 Hotterscheit Joseph, shoemaker, 79 North Water, boards 136 Hudson
 Hottes Charles, carpenter, r. 54 North av. h. 25 Weld
 Hottes Charles F. woodworker, 3 Elizabeth, boards 25 Weld
 Hottes Elizabeth, widow, boards 25 Weld
 Houck Edward, shoemaker, house 30 Tyler
 Houckelman Joseph, removed from city
 Hough E. A. Mrs. widow, bds. 171 Alexander
 Hough Lyman C. carpenter, h. 8 N. Union
 Hough Mary B. dressmaker, 171 Alexander, house do. [Union
 Hough Mary J. music teacher, boards 8 N.
 Hough Norman (*Wm. H. De Puy & Co.*), 92 Allen, house 34 Prospect

HENRY C. WISNER,

**CUT AND PRESSED GLASS TABLE WARE,
 No. 33 STATE STREET.**

Houghtaling John, conductor, N. Y. C. R.
R. house 6 Frank [Madison
Houghtaling Richard A. agent, house 39
Houghton Alfred, bookkeeper, h. 4 Helena
Houghton Anna Mrs. dressmaker, 14 Helena,
house do. [McCracken
Houghton Geo. A. hostler, b. Straub alley n.
Houlihan John A. blacksmith, 129 Mill, h.
99 Jones [house 21 West
Hourigan Daniel F. cooper, West n. Lyell,
Hourigan Richard, cooper, West near Lyell,
boards 21 West
Housam Jane, widow, house 14 Grove
Housam John, painter, house 14 Grove
House Frederick, laborer, h. 15 Monroe av.
House Frederick G. gilder, 110 Front, boards
76 Exchange
House George, saloon, 33 Front, house do.
House George W. clerk, 12 W. Main, b. 138
North St. Paul
House Horace L. student, Roch. Theological
Seminary, boards Trevor Hall
House John, foreman, h. 138 North St. Paul
House John, gardener, h. Sibley n. Culver
House John P. cutter, 10 West Main, house
20 Almira
House Lucinda, widow, house 55 Goodman
Houser Andrew, teamster, h. r. 76 Mt. Hope
avenue [Goodman
Houser Charles, laborer, house Harvard cor.
Houser Frederick, gardener, bds. Harvard
corner Goodman
Houser see Hauser
Houston Charles G. (*Westcott & Houston*), and
(*Walsh, Westcott & Co.*), 196 State, house
2 Villa place [38 Nassau
Houston Elizabeth (*Houston & Draper*), bds.
Houston John, gardener, h. Edmonds near
Pearl [Pearl
Houston John jr. gardener, b. Edmonds n.
Houston Mary Ann, widow, h. 38 Nassau
Houston & Draper (*E. Houston and C.
Draper*), umbrella manuf. 3 Elwood blk.
Houter Julia, widow, house r. 94 Exchange
Hovey Albert R. removed from city
Hovey Bleeker L. physician, 35 Fitzhugh,
house do. [h. 131 University av.
Hovey Douglas, albumen paper, 32 N. Water,
Hovey Frank H. pension agent, boards 35
Fitzhugh
Hovey Luther, farmer, house Thurston road
Hovey Luther H. (*Hovey & White*), house 31
Greig
Hovey & White (*L. H. Hovey and T. E. White*),
lawyers, 65 Powers' buildings
Howard Adam, horse trainer, Roch. driving
park, house Straub alley n. McCracken
Howard Almeron, foreman, h. 89 Plymouth
av. [Jones, h. 28 Saratoga avenue
Howard Chauncey M. blacksmith, Brown c.
Howard Chauncey P. driver, 104 Plymouth
av, house 89 do. [perance bldgs.
Howard Elijah, tinsmith, house 54 Tem-
Howard Elmer, tinsmith, house 14 Davis
Howard Ella, stitcher, boards r. 61 Prospect
Howard Elmira M. dressmaker, 89 Ply-
mouth av. b. do. [poorhouse, b. do.
Howard Eugene H. warden, Monroe county

Howard Frank, shoemaker, 15 Mill, boards
28 Saratoga avenue
HOWARD HAMILTON H. contractor and
builder, 112 E. Main, and (*H. A. Kings-
ley & Co.*), boards Whitcomb House.—
See page 636
Howard Henry M. mason, house 1 Diem
Howard Henry R. salesman, bds. 145 Frank
Howard Isaac I. correspondent, 93 State, h.
38 Adams [av. cor. Magnolia
Howard James, whitewasher, h. Plymouth
Howard Jas. deceased November, 1875
HOWARD JAMES O. liquor importer, 114
State, house 185 do.—*See page 563*
Howard John, blacksmith, 3 Canal, house
30 Julia
Howard John, laborer, house 5 Smith
Howard John L. (*Warner, Stockbridge & Co.*),
18 Arcade, house at Chicago
Howard John P. actor, Roch. Opera House,
b. Chapman House [h. 22 White
Howard Joseph, teamster, Frankfort Mills,
Howard Joseph I. salesman, 93 State, bds.
Clinton Hotel
Howard Mary, dressmaker, 49 State, h. 38
Adams [sing, b. 4 Walnut
Howard Michael, switchman, Platt st. cros-
Howard Patrick, plumber, boards 5 Smith
Howard Patrick, cooper, Butler c. Charles,
boards 4 Walnut
Howard Robert, teamster, house 6 Tracy pk.
Howard Sarah L. widow, house 145 Frank
Howard Thomas, removed from city
Howard Thomas, pressman, boards 5 Smith
Howard William H. boards 1 School alley
Howard William L. clerk, 347 State, boards
Saratoga avenue corner Lorimer
Howden John H. cashier, 17 State, boards 4
North Washington [b Whitcomb House
Howe David W. livery stable, 17 Andrews
Howe Edwin G. bookkeeper, 45 Fitzhugh, b.
42½ Fitzhugh
Howe Elizabeth, widow, house 24 Asylum
HOWE HARLEY J. & CO. (*A. Leggett*),
scale manufacturers, 3 Andrews, house
58 Delevan.—*See page 618*
Howe Henry B. student, University of Roch.
b. 30 South Clinton [boards 42½ do.
Howe Jacob jr. (*J. Howe & Son*), 45 Fitzhugh,
Howe Jacob & Son (*Jacob Howe jr.*), bakery,
45 Fitzhugh, house 42½ do.
Howe John (*John H. Howe & Co.*), house 168
Alexander
Howe John H. & Co. (*J. Howe*), plumbers,
48 East Main, b. 168 Alexander
Howe John H. (*Howe & Rogers*), 37 State, h.
30 South Clinton [boards 37 Stone
Howe J. Milton, pattern maker, 10 S. Water,
Howe Michael, gasfitter, at Gas Works, house
32 South Washington
Howe Richard, wiper, Exchange opp. Glas-
gow, b. River road n. Eric R. R.
Howe Sarah J. dressmaker, boards 54 Kent
Howe Sarah W. teacher, Munger School, No.
13, house 169 Alexander
HOWESEWING MACHINE CO. 69 State.
—*See page 578*
Howe Thomas, carriagemaker, h. 50 Vienna

- Howe Thomas F. foreman, 65 North Water, boards York House
- Howe William, watchman, house Wolcott road n. railroad bridge [House]
- Howe William, salesman, 53 E. Main, b. York
- Howe William, cigarmaker, 7 Childs, b. do.
- HOWE & ROGERS** (*J. H. Howe and Clinton Rogers*), carpets, oil cloths and matting, 37 State.—*See page 628*
- Howell Dudley F. student, Roch. Theological Seminary, boards Trevor Hall
- Howell Edmund W. house 3 New York
- Howell Edwin, geologist, bds. 2 College av.
- Howell Frederick D. paleontologist, boards 2 College avenue
- Howell Richard D. house 32 Broadway
- Howell Samuel, clerk, 73 East Main, h. 34 Broadway
- Howes Carlos D. clerk, Erie Railway freight house, house 19 Hamilton place
- Howes James E. dep. supt. Monroe Co. penitentiary, house 12 Alexander
- Howes Joseph, currier, 51 N. Water, house 25 University avenue [Albion]
- Howes Samuel R. (*Howes & Beebee*), house at
- HOWES & BEEBEE** (*S. R. Howes and E. Beebee*), croquet manufs. 111½ N. Water.—*See page 676* [av. house 164 State]
- Howland Albert M. restaurant, 8 Railroad
- Howland Charles J. Mrs. widow, h. 64 N. Clinton
- Howland Chauncey W. removed to Geneva
- Howland Edgar J. clerk, 19 Mill, b. 11 N. Ford [house 18 Court]
- Howland George, expressman, 35 Exchange, Howland Jesse, trunkmaker, foot Rowe, h. 11 N. Ford [51 Ontario]
- Hoxie Orrin, machinist, Court cor. Stone, h. Hoxie Wm. L. removed to Cayuga
- Hoy Ann, widow, house 8 W. Maple [Allen]
- Hoy Peter, chair finisher, 184 State, bds. 54
- Hoyt Alfred, collector, Union & Advertiser, 82 West Main, house 10 Mathews
- Hoyt Anna E. widow, boards 9 Fitzhugh
- Hoyt A. J. Mrs. matron, Rochester Theological Seminary, boards do. [inary, b. do.]
- Hoyt A. Jay, janitor, Roch. Theological Sem-
- Hoyt Charles B. rec. teller, Powers' banking house, bds. 9 Scio [Water, b. 34 Troup]
- Hoyt Charles E. (*Williams & Hoyt*), 79 N.
- Hoyt Charles H. clerk, boards 21 Tremont
- Hoyt Daniel B. salesman, 103 State, h. 51 Court [25 Court]
- Hoyt Daniel V. salesman, 53 E. Main, bds.
- Hoyt David, paying teller, Monroe Co. Savings Bank, 31 State, house 8 East
- Hoyt Elizabeth A. teacher, 24 East av. bds. 25 Court [E. Main]
- Hoyt E. Foster, agent, 31 Exchange, h. 190
- Hoyt George H. salesman, 48 E. Main, h. 25 Gardiner park [Glasgow]
- Hoyt Henry B. salesman, 40 W. Main, h. 14
- Hoyt Henry W. agent, 57 State, h. 21 Tremont
- Hoyt Hiram, 79 N. Water, house 34 Troup
- Hoyt Lewis S. jr. assist. bookkeeper, City Bank, 34 State, boards 9 Fitzhugh
- Hoyt Mary, domestic, Osburn House
- Hoyt Mary A. Miss, boards 9 Scio
- Hoyt Mary M. B. widow, house 9 Scio
- Hoyt Sarah, widow, house 25 Court
- Hoyt Webster, laborer, h. 111 Mt. Hope av.
- Hoyt Wm. E. ticket agent, Canada Southern railway, 100 Railroad av. bds. 2 King
- HOYT WILLIAM B.** freight agent, Canada Southern Line, 100 Railroad avenue h. 2 King.—*See Railroads in Contents*
- Hoyt W. Mason, salesman, 33 State, b. 9 Scio
- Hub Adam, carpenter, h. 28 Buchan park
- Hubachek Henry G. printer, bds. Jay opp. Ames
- Hubachek Joseph, house Jay opposite Ames
- Hubbard Benjamin L. deceased April, 1876
- Hubbard Eliza, widow, house 13 Swan
- Hubbard James, sailmaker, 42 Exchange, b. 146½ West Main [road at rapids]
- Hubbard John D. teamster, h. Scottsville
- Hubbard Margaret E. widow, h. 38 Asylum
- Hubbard Menzo W. ins. agt. house 134 S. St. Paul
- Hubbard Oella C. widow, bds. 2 S. Clinton
- Hubbard Walter, farmer, h. Scottsville road at rapids [ville road at rapids]
- Hubbard Walter C. brickmaker, h. Scotts-
- Hubbard Walter E. shirt manuf. 110 State, house do.
- Hubbard William A. secretary Rochester Paper Co. lower falls, h. 7 Phelps av.
- Hubbard Wm. A. jr. bookkeeper, 24 State, boards 7 Phelps avenue
- Hubbard Wm. H. cigar manuf. 87 North, h. North c. Clinton place [7 Clinton pl.]
- Hubbell Charles H. clerk, 17 W. Main, bds.
- Hubbell Elizabeth, seamstress, house 51½ Gregory
- Hubbell Maria G. widow, h. 36 Concord av.
- Hubbell Mary A. widow, h. East av. c. Meigs
- Hubbell Walter S. lawyer, 43 Powers' bldgs. boards 1 Fitzhugh
- Hubeli Abraham, grocer, St. Joseph corner Vienna, house do.
- Huber Anthony, laborer, house 88 Weld
- Huber Balthazer, machinist, Mill cor. Platt, boards 44 Campbell
- Huber Barbara, widow, house 29 Oakman
- Huber Charles F. (*F. Zimmer & Co.*), 78 Front, house 153 Hunter
- Huber Clara Miss, seamstress, b. 29 Oakman
- Huber Frank, laborer, h. 175 Pinnacle av.
- Huber Geo. A. carver, boards 29 Oakman
- Huber Jacob, laborer, h. Ackerman cor. Bay
- Huber Jacob, market, Mt. Hope av. c. South avenue, house 20 Comfort
- Huber John J. deceased October 1, 1875
- Huber Joseph, wheelmaker, 3 Elizabeth, h. 8 Marion
- Huber Joseph, house 31 Wadsworth
- Huber Kate, widow, house 44 Campbell
- Huber Lawrence, frame finisher, 38 Gorham, boards 341 State
- Huber Michael, laborer, house rear 9 Comfort
- Huber Philip, deceased November 15, 1875
- Huber Valentine, cooper, house 126 Jay
- Huber Valentine H. cooper, 50 Orchard, h. 46 West Maple [54 Weld]
- Hubertang George, teamster, 56 Hudson, h.

HENRY C. WISNER,

DECORATED CHINA, SILVER SETS,
No. 33 STATE STREET,

Hubertang Laurence, laborer, 56 Hudson, h. 52 Weld [house 40 Joiner
 Huberth Peter J. shoemaker, 127 East Main,
 Hubner George, blacksmith, 150 North Water, house 96 Orange
 Hubner Theresa, weaver, boards 96 Orange
 Hubner Wm. M. clerk, 1 Front, b. 96 Orange
 Hubregtse Abraham, gardener, h. 31 Cypress
 Hubregtse Adrian, nurseryman, h. 34 Cypress
 Huck Albert, laborer, house 28 Smith
 Huck Anthony, carpenter, h. 71 W. Smith
 Huck Bernard, mason, house 92 Adams
 Huck Charles, cigarmaker, 147 E. Main, b. 311 Brown
 Huck Edward, engineer, house 35 King
 Huck Edward, cooper, Butler cor. Charles, house 4 Romeyn
 Huck Edward jr. cooper, h. 197 St. Joseph
 Huck Florence, warehouseman, Brown cor. Warehouse, h. 73 King [b. 4 Romeyn
 Huck Frank, cooper, Butler corner Charles,
 Huck Frank, moulder, 8 Hill, bds. 73 King
 Huck Frederick, fireman, bds. 311 Brown
 Huck George, sawyer, house 100 Saxton
 Huck John, spectacle maker, boards 71 Allen
 Huck Joseph, boxmaker, 3 Aqueduct, bds. 368 Brown
 Huck Julia, widow, boards 110 Hudson
 Huck Julia L. widow, house 368 Brown
 Huck Julia K. widow, house 122 Jay
 Huck Louis, carpenter, boards 122 Hudson
 Huck Mary A. widow, house 311 Brown
 Huck Regina, widow, house 108 Orchard
 Huck Thomas G. shoemaker, 15 Mill, house 35 Saxton [b. 130 West av.
 Huddleston Edmund R. bookkeeper, 62 State,
 Huddleston Peter, house 130 West avenue
 Huddy Mary, widow, house 68 Savannah
 Huddy Richard, laborer, bds. 68 Savannah
 Huddy Wm. painter, boards 68 Savannah
 Hudson B. Eugene, cutter, Andrews cor. N. Water, b. 106 Orange [Orange
 Hudson Oliver, shoemaker, 5 Magne, h. 106
 Hudson Catharine, stitcher, boards 48 Frank
 Hudson Charles B. bookkeeper, 77 North Water, b. 8 Washington Hall
 Hudson Frederick G. rem'd to Connecticut
 Hudson Harry B. removed from city
 Hudson Henry D. clerk, 42 Exchange, house 2 Cypress [Main, h. 14 Elizabeth
 Hudson J. William, carriagemaker, 194 W
 Hudson Newlands, shoemaker, 15 Mill, h. Tremont near G. V. canal
 Hudson Richard, taxidermist, h. 18 Philander
 Huels John B. cabinetmaker, boards Hudson near Alphonse [h. do.
 Huels John H. grocer, Hudson n. Alphonse,
 Huette William, baker, 11 King, house do.
 Hufeland John F. bookkeeper, house 106½ West Main
 Huff Hannah, bds. East av. cor. Alexander
 Hughes Ann, widow, house r. 4 Litchfield
 Hughes Augustine L. clerk, 214 State, bds. 42 Prospect
 Hughes Edward, plumber, h. 56 North av.
 Hughes Elizabeth, widow, boards 28 Elm
 Hughes Francis L. (Jacobs & Hughes), 166 W. Main, house 54 Adams

Hughes George W. clerk, 64 State, house 151 Frank
 Hughes Henry A. carriage painter, 157 West Main, h. 2 Pear alley [9 Lancaster
 Hughes James, tinsmith, 144 E. Main, bds.
 Hughes James E. student, 41 State
 Hughes John, machinist, Brown's race near Furnace, house 128 Lake av. [Frank
 Hughes John, clerk, 60 West Main, h. 155
 Hughes John H. bookseller, 52 S. St. Paul, boards 209 State
 Hughes Joseph, bricklayer, h. 11 Granger
 Hughes Juliette, widow, h. 100 Caledonia av.
 Hughes Margaret L. widow, h. 42 Prospect
 Hughes Martin, plumber, 25 Exchange, bds. 56 North avenue
HUGHES MICHAEL L. toys, fancy goods, etc. 110 State, house 8 N. Washington.— [Sarotoga av.
See page 507
 Hughes Nancy, widow, house Costar near
 Hughes Nelson A. clerk, 64 West Main, h. 10½ East Main [40 Saxton
 Hughes Peter, groom, State cor. Centre, bds.
 Hughes Peter, coachman, 100 Fitzhugh, h. 152 do. [William
 Hughes Peter, detective, City Hall, house 63
 Hughes Sarah Miss, dressmaker, b. 24 Morris
 Hughes Stephen H. boottreer, 77 N. Water, house 10½ E. Main n. Stillson
 Hughes Wm. wagonmaker, 71 East av. h. do.
 Hughes William H. machinist, 100 South St. Paul, house 102 Broadway
 Hughes William P. bookkeeper, 166 West Main, boards 42 Prospect
 Hughes, see Heughes and Hewes
 Huhn August (Huhn Bros.), bds. 55 Henry
 Huhn Bernard, laborer, house 55 Henry
 Huhn Bros. (E. and A. Huhn), bakers, 55 Henry
 Huhn Edward (Huhn Bros.), bds. 55 Henry
 Huhn Helen M. Mrs. house 3 Schleyer's blk.
 Huibregtsen John, carpenter, house 17 Pryor
 Huibregtsen Wilhelmina, widow, b. 17 Pryor
 Hulbert Adelbert E. plumber, 96 East Main, boards 58 Munger [Washington
 Hulbert Claude, shoemaker, boards 12 North
 Hulbert Edwin T. boatman, h. 97 South av.
 Hulbert J. Earl, boots and shoes, East Main corner N. Water, house at Brighton
 Hulbert Maggie Miss, house 198 West Main
 Hulbert Moses H. brakeman, N. Y. C. R. R. house 108 State
 Hulbert Osmer S. dining room, Front corner East Main, house 60 Atkinson
 Hulce Eliza, widow, house 38 Romeyn
 Hulce Warren A. laborer, Brown c. Jones, boards 38 Romeyn [b. 38 Romeyn
 Hulce William H. laborer, Brown c. Jones,
HULETT ALONZO I. agent, Brooklyn Life Ins. Co. 45 Powers' bldgs. house 36 Greig.—*See page 506* [North av.
 Hulet John, saloon, 173 East Main, bds. 20
 Hulet John W. clerk, 83 State, boards 12 Joslyn park
 Hulet Pierson B. lawyer and special county judge, 62 Arcade h. 25 N. Clinton
 Hulet Thaddeus W. bookkeeper, 114 State, house 12 Joslyn park

Hulin Truman, h. Scottsville road at rapids
 Huling Perry G. engineer, N. Y. C. R. R. h.
 14 Orange
 Hultenschmidt Charles jr. dec'd Oct. 1875
 Hultenschmidt Charles L. W. painter, house
 73 St. Joseph
 Hultenschmidt C. August, painter, boards
 McCracken near Lake av. [n. Lake av.
 Hultenschmidt Wm. painter, h. McCracken
 Hultenschmidt Margaret, widow, house 195
 North
 Humburch George, removed to Buffalo
 Humburch John H. bookkeeper, 18 State,
 boards 9 East avenue [Martin
 Hummel Charles G. clerk, 8 Hill, house 32
 Hummel Christian, baker, 128 North av. b. do.
 Hummel George, glassblower, 178 Plymouth
 boards Plymouth avenue cor. Clarissa
 Hummel John, removed to Milwaukee, Wis.
 Hummel Regina, domestic, 44 Lake avenue
 Humphrey Frank S. reporter, 3 W Main, b.
 84 E. Main [rey], h. 13 Atkinson
 Humphrey George H. (H. & G. H. Humph-
 Humphrey George H. clerk, 93 State, house
 36 Trowbridge
 Humphrey Harvey & G. H. lawyers, 112
 Powers' bldgs. house 7 N. Washington
 Humphrey Hezekiah (Humphrey & Bro.), h.
 27 Hill
 Humphrey John P. (A. Churchill & Co.), 71
 State, boards 3 North Washington
 Humphrey Leonard H. (Humphrey & Bro.),
 house 21 Romeyn [27 Hill
 Humphrey Washington G. cigarmaker, bds.
 Humphrey William, teamster, h. 315 State
 Humphrey & Bro. (H. and L. H. Humphrey),
 stairbuilders, Scott alley
 Hungerford Fayette, house 79 East avenue
 Hungerford Newell L. clerk, 300 Monroe av.
 house Monroe av. near toll gate
 Hungerford Sarah P. widow, h. 32 S. Clinton
 Hungerford Susan, widow, house Monroe av.
 near toll gate
 Hungerford Thomas A. lawyer, 58 Powers'
 bldgs. boards 36 North Washington
 Hunn Adeline, widow, house 12 S. St. Paul
 Hunn Charles, hairdresser, h. 119 Chatham
 Hunn David L. jr. 74 State, h. 89 Alexander
 Hunn David L. Rev. house 83 Alexander
 Hunn Francis S. (Hunn, Spencer & Co.), 74
 State, h. 83 Alexander [2 Champion
 Hunn Henry D. upholsterer, 74 State, house
 Hunn Joseph S. student, bds. 83 Alexander
 Hunn Joseph S. carriagemaker, h. 55 Hickory
HUNN, SPENCER & CO. (F. S. Hunn,
 H. S. M. and B. Spencer), furniture ware-
 rooms, 74 State.—See page 612
 Hunn Tiffany, deceased April 6, 1876
 Hunn Wilbur, clerk, boards 55 Hickory
 Hunn William C. clerk, 27 East Main, bds.
 83 Alexander [110 Fitzhugh
 Hunt Alfred B. fireman, Erie railway, house
 Hunt Charles & H. hairdressers, 48 West av.
 boards 98 North St. Paul
 Hunt Christopher, painter, h. 136 St. Joseph
 Hunt Daniel T. postmaster, Arcade, and
 (Kenyon & Hunt), 100 State, house 34
 Monroe avenue

Hunt Edward W. teamster, 90 South St. Paul,
 boards Lewis
 Hunt George, blacksmith, house 57 Martin
 Hunt George, cartman, b. 20 Caledonia av.
 Hunt Gottlieb, tailor, house 98 N. St. Paul
 Hunt Henry (C. & H. Hunt), 48 West av.
 boards 89 North St. Paul
 Hunt Horace H. student, University of Roch-
 ester, boards 15 James
 Hunt James, shoemaker, house 107 Hunter
 Hunt James, cartman, 53 East Main, boards
 20 Caledonia avenue
 Hunt James M. clerk, boards 52 Clifton
 Hunt John, hostler, Clinton Hotel, bds. do.
 Hunt John, cartman, house 52 Clifton
 Hunt John, carpenter, house 15 Weld
 Hunt John jr. carpenter, house 17 Weld
 Hunt John C. clerk, boards 52 Clifton
HUNT JOHN K. paper box manufacturer,
 91 N. Water, and (A. H. Fay & Co.), b.
 144 Adams.—See page 645
 Hunt Joseph, shoemaker, 75 West avenue,
 house 76 Clifton
 Hunt Rebecca, widow, h. 20 Caledonia av.
 Hunt Richard, shoemaker, 33 West avenue,
 house 144 Adams
 Hunt Walter, carpenter, house 4 N. Stillson
 Hunt William, laborer, b. 20 Caledonia av.
 Hunt William F. clerk, house 52 Clifton
 Hunt William J. boxmaker, 91 North Water,
 boards 144 Adams
 Hunter Alice Miss, house 48 East avenue
 Hunter Anna B. housekeeper, 28 East avenue
 Hunter David, millwright, 127 Mill, house
 206 Alexander [Main
 Hunter Elizabeth A. boarding house, 119½ E.
 Hunter Ella Miss, boards Bloss c. Fulton av.
 Hunter George, grocer, 23 Lake av. h. 25 do.
 Hunter George N. laborer, h. r. 19 Sanford
 Hunter Henry, coachman, house 14 Ashland
 Hunter James, drygoods, 23 Monroe av. h. do.
 Hunter John, laborer, h. Stanley n. South av.
 Hunter John E. carpenter, h. 54 Hamilton pl.
 Hunter John F. hairdresser, 131 West Main,
 house do.
 Hunter John W. clerk, 17 State, h. 8 Kent
 Hunter Joseph R. clerk, 82 State, boards 25
 Lake avenue
 Hunter Josephine, widow, house 2 Sophia
 Hunter Julia H. Mrs. boarding house, 8 Kent
 Hunter Thomas, house 26 Weld [11 Hill
 Hunter Thomas M. waiter, 36 W. Main, bds.
 Huntington Benjamin, h. 55 University av.
 Huntington Calvin G. bookkeeper, bds. 21
 Chestnut
 Huntington Charles W. teller, Commercial
 Bank, 31 West Main, house 17 Fitzhugh
 Huntington Edward T. clerk, 31 West Main,
 boards Wood's Hotel
 Huntington Edwin (M. & E. Huntington),
 house 106 University avenue [Hotel
 Huntington Edwin T. agent, bds. European
 Huntington Elon (H. B. Hooker & Co.), 250
 North St. Paul, house do.
 Huntington George, house 21 Chestnut
 Huntington G. Clark, salesman, h. 5 Emerson
 Huntington Henry F. cashier, Commercial
 Bank, 31 W. Main, h. West av. c. Colvin

Huntington John F. trees, house 73 Tappan
Huntington Martin (*M. & E. Huntington*),
house 22 Chestnut

HUNTINGTON M. & E. (*Martin and Ed-
win Huntington*), paints, oils, &c. 36 E.
Main.—*See front colored page*

Huntington Nathan, house 23 Chestnut
Huntington Sarah A. boards 32 Stone
Huntington Ward, house 23 Chestnut
Huntley Charles, boards 5 Reynolds
Hup John, carpenter, house Mauder's park
Hupner John, finisher, 184 State, boards 96
Orange

Hurd Charles W. teamster, h. 23 Lake av.
Hurd Edwin H. (*E. H. and G. F. Hurd*), 62
Sophia, house do.

Hurd Emma, sewer, boards 4 Jay
Hurd E. H. & G. F. (*Edwin H. and George F.
Hurd*), physicians, 62 Sophia [28 Platt

Hurd George F. (*E. H. & G. F. Hurd*), house
Hurd Susan Mrs. house 9 North Ford
Hurlbert Edwin, shoemaker, 15 Mill, h. 215
Jones

Hurlbert Edwin N. turner, boards 215 Jones
Hurlbert Adelphi plumber, bds. 58 Munger
Hurlbert Albert, clerk, 220 W. Main, boards
52 Gregory

Hurlbert Sarah, widow, bds. 1 University av.
Hurlbut Mary E. widow, h. 23 Clinton place
Hurlbut Alvin, carpenter, b. 12 Schleyer blk.

Hurley George L. removed to Covington, Ky.
Hurley John, forger, boards 48 Jones
Hurley John, house 31 Broadway

Hurley Julia, cook, Congress Hall, boards do.
Hurley Lizzie Miss, corkcutter, 205 Plymouth
avenue, boards 58 Champlain

Hurley Margaret, widow, h. 6 Sauer's park
Hurley Margaret M. domestic, b. 155 Alexander
Hurley Michael, painter, house 27 Atkinson

Hurley Patrick, laborer, house 63 West av.
Hurley Patrick, laborer, bds. 6 Sauer's park
Hurley Thomas, mason, house 58 Champlain

Hurley Thomas F. policeman, City Hall, h.
304 State [State, h. 168 Frank
Hurley Thomas J. (*S. J. Arnold & Co.*), 103

Hurrell Servington, saloon, 18 Market, h. do.
Hursch George H. cigarboxmaker, 11 Aque-
duct, house 5 Sauer's park

Hursh John H. hostler, 6 Lancaster, house
13 Green
Husband Thomas B. lawyer, 111 Powers'
buildings, boards 6 Chestnut

Husband Thomas H. rec. cashier, Rochester
Savings Bank, West Main cor. Fitzhugh,
boards 52 Edinburgh

HUSBANDS JOSEPH D. lawyer, 143 Pow-
ers' buildings, house 33 Fitzhugh.—*See*
page 512 [iversity av.

Husbands Minnie B. b. Culver place n. Uni-
Husbands Richard, conductor, house Culver
place near University avenue

Husmann Henry, carpenter, h. 316 N. Clinton
Huson Catharine E. widow, h. 57½ Chestnut
Huson Hobart, clerk, Post Office, boards 57½
Chestnut

Huson John R. salesman, 24 State, boards
North St. Paul near Mortimer
Hussey Ann, widow, h. North York n. R. R.

Hussey Catharine, widow, h. 57 N. Clinton
Hussey Charles G. (*Leary & Co.*), 93 W. Main,
boards 28 Caledonia avenue

Hussey Charles S. baths, 59 State, boards
31 Court [West avenue

Hussey John, clerk, 138 W. Main, b. York n.
Hussey Nancy R. widow, b. 28 Caledonia av.
Hussey Thomas M. grocer, 37 Monroe av. h.
5 Green [212 W. Main

Husted William N. teamster, 30 West av. h.
Hutchings Frederick, bookkeeper, boards
334 State

Hutchins Charles D. agent, h. 153 West av.
Hutchinson Abigail, widow, b. 83 South av.
Hutchinson Edward T. driver, 69 State, h.
3 Charlotte [4 Mortimer

Hutchinson Frank B. lawyer, 52 Arcade, h.
Hutchinson George R. porter, h. 201 State
Hutchinson Hannah, deceased May 22, 1876

Hutchinson James, deputy collector, Custom
House, 31 State, house 3 Meigs
Hutchinson Lorin, house 3 Charlotte

Hutchinson Maria, widow, house 57 Prospect
Hutchinson Mary, widow, h. r. 21 Tappan
Hutchinson Mary A. widow, h. 79 Tappan

Hutchinson Nancy, widow, b. Bismarck n.
Genesee [154 Exchange

Hutchinson William, machinist, 43 State, b.
Hutchinson William H. bookkeeper, 44 Ex-
change, boards rear 21 Tappan

Hutsman Henry, laborer, house 5 Holland
Hutson Ezra, machinist, house 31 Strong
Hutte Charles, boots and shoes, 85 N. Clinton,
house do.

Hutter Anna, stitcher, boards 80 Orchard
Hutter Arnold F. blacksmith, East Main c.
Goodman, house 2 Ashland

Hutter Frederick, mason, 69 Hudson, h. do.
Hutter G. Nicholas, mason, h. 32 Buchan pk.
Hutter John, plasterer, 16 Stone, b. 69 Hudson

Hutter Margaret, stitcher, boards 80 Orchard
Hutter Philip, mason, house 12 Barlett
Hutter Teresia, widow, house 80 Orchard

Huyck Charles F. salesman, 53 E. Main, bds.
89 Fitzhugh

Huyck Philip P. tailor, house 89 Fitzhugh
Hyatt Eliza Mrs. boarding house, 205 State
Hyatt Sarah A. Mrs. dressmaker, 9 N. Clin-
ton, house do.

Hyatt Theodore H. house 205 State
Hyde Andrew, bricklayer, b. 113 Broadway
Hyde Charles, real estate, 36 Arcade, house
16 Gardiner park

HYDE D. CAMERON, lawyer, 91 Powers'
bldgs. h. 9 S. Washington.—*See page 512*

Hyde Elisha F. & Co. (*E. M. Higgins*), gro-
cers, 64 E. Main, house 87 East avenue
Hyde James, carpenter, house 113 Broadway

Hyde John, tobacconist, 10 Exchange place,
house 87 East Main [h. 37 Hill
Hyde Joseph F. stonecutter, 97 N. St. Paul,

Hyde Michael, cigarmaker, 6 East Main, b.
Pinnacle av. n. Henrietta avenue
Hyde Patrick, carpenter, 45 Monroe avenue,
h. Pinnacle av. n. Henrietta avenue

Hyde Robert, clerk, 4 West Main, b. 55 Pearl
Hyland John, foreman, Citizens' Gas Com-
pany, North St. Paul, h. 35 Martin

Hyland John, trimmer, boards 87 South av.
 Hyland Joseph, fireman, boards 20 Canal
 Hyland Mary Miss, forewoman, b. 25 Hudson
 Hyland Michael, laborer, house 64 Strong
 Hyland Michael, policeman, City Hall, h. 20 Canal [64 Strong
 Hyland Michael J. shoecutter, 124 Front, b.
 Hyman Joseph, tailor, boards 54 Chatham
 Hyne George H. carpenter, boards 23 Pearl
 Hyne Jacob, burnisher, house 23 Pearl
 Hyne Lewis F. nurse, 77 Plymouth av. b. do.
 Hynes Charity, widow, house 19 Jay
 Hynes Martin, hostler, boards 18 Kirk
 Hynes Michael, stable, 88 N. Water, house 18 Kirk
 Hynes Patrick, doper, boards 18 Kirk
 Hynes Rebecca Mrs. house 5 Ambrose
 Hynes William J. removed to Silver Star, Montana, Territory
HYSNER DANIEL, carriage trimmer, Chatham c. Franklin, house 23 Swan.—
See page 603 [house 62 Prospect
 Hysner Henry, carriage maker, 3 Canal,
 Hysner Jennie, stitcher, 62 Prospect
 Hysner John, carriage trimmer, b. 23 Swan
 Hysner Julius W. carriage trimmer, boards 23 Swan
 Hysner Philip G. foreman, h. 116 Atkinson
 Hysner William, brakeman, boards 16 King
 IAGO CATHARINE, seamstress, b. 13 Lancaster
 Ihrig Adam, market, 106 Chatham, h. do.
 Ihrig George, market, 68 Hudson, house do.
 Ihrig George W. butcher, b. 42 N. Clinton
 Ihrig John, market, 42 N. Clinton, house do.
 Ihrig Michael, butcher, 106 Chatham, b. do.
 Ihrig see Ehrig
 Iles Daniel, house 30 Delevan
 Iles Emma E. teacher, Atwater School No. 10, bds. 30 Delevan
 Illig Joseph, glass blower, 178 Plymouth av. house Bartlett cor. Reynolds
 Imhof Fred. saloon, 124 N. Clinton, h. do.
 Imhof Fred. jr. clerk, 124 N. Clinton, b. do.
 Imhof Louis, cabinetmaker, 22 S. St. Paul
 Imo Conrad, miller, house 15 Galusha
 Imo Louis, peddler, house 14 Morris
 Ineson George, car inspector, N. Y. C. R. R. Platt n. John, h. 52 Thompson
 Ingalls George M. (*Ingalls & Schwikert*), h. 7 Stillson
 Ingalls & Schwikert (*G. M. Ingalls and F. Schwikert*) billiards, 4 Mill
 Ingersoll Alicia, widow, house 121 Lake av.
 Ingersoll Geurdon jr. clerk, 14 Exchange, h. 22 Upton park
 Ingersoll Hattie A. clerk, bds. 121 Lake av.
 Ingersoll Henry M. painter, h. 23 Orchard
 Ingersoll Jared B. papermaker, boards 121 Lake avenue.
 Ingersoll William J. boards 121 Lake av.
 Ingham Jonas, moulder, 20 Court, house Michigan near Bauer
 Ingling Peter C. collarmaker, 129 State, bds. 81 Pinnacle avenue
 Inglis John S. clerk, 14 Exchange, boards Whitcomb House [West av.
 Inglis Peter L. clerk, 147 State, boards 100

Ingmire William H. tallyman, house 11 Waverly place
INGRAHAM WILLIAM L. water filters, rope and twine, 77 Exchange, bds. 170½ West Main.—*See page 513*
 Inman Herman C. mason, h. Hunter n. Saxe
 Inman Isaac L. mason, house 73 Hunter
 Inslee Lucinda E. Mrs. house 91 N. Clinton
 Inteman Henry, milkman, boards 67 Nassau
 Ireland Benjamin, boards 131 Meigs
 Ireland Frank S. painter, h. Evergreen park near Clifford
 Ireland George, laborer, b. 162 North av.
 Ireland Henry O. removed to Auburn
 Ireland John, 7 Masonic blk. h. 46 Alexander
 Ireland William H. H. clerk, Erie Railway freight office, house 42 Alexander
IRISH JACOB P. druggist, 255 State, h. 58 Lorimer.—*See page 570*
 Irvine Phebe Mrs. house 76 Jay
 Irvine Robert, salesman, 73 E. Main, house 70 Williams [Genesee
 Irvine William, salesman, house Bismarc n.
IRVING ALBERT G. carver, 1 N. Water, house Bernard n. Thomas.—*See page 629*
 Irving William, agent, 149 State, b. 130 Jones
 Irwin Cyrene, dressmaker, b. 29 Hamilton pl.
 Irwin David, removed to Troy
 Irwin Francis J. city messenger, City Hall, house 7 North Stillson
 Irwin Jacob S. & Co. (*J. H. Bullard*), files, 107 Mill, house 41 Adams
 Irwin James C. carriage maker, 145 E. Main, boards 8 Sycamore
 Irwin Nancy, widow, house 29 Hamilton pl.
 Irwin William, tinsmith, b. 29 Hamilton pl.
 Irwin see Erwin
 Isabel Sister, teacher Nazareth convent, Jay corner Frank
 Isbister John H. removed to Niagara Falls
 Isenman Frederick, confectioner, 79 North Clinton, boards do.
 Isenman John optician, 179 N. St. Paul, b. North av. corner Jennings
 Isenman Meinard, blacksmith, house North avenue cor. Jennings [house do.
 Islep George, hairdresser, 215 North Clinton,
 Iven Julia, boarding house, 37 N. St. Paul
 Ives George C. fireman, N. Y. C. R. R. bds. 8 James [8 James
 Ives Henry A. brakeman, N. Y. C. R. R. b. Ives Henry C. lawyer, house 8 James
 Ives James R. student University of Roch. b. 5 Scio
 Ives Sophia, boarding, house 35 Spring
 Iwig Catharine, widow, house 19 Concord av.
 JACKSON ABRAM, salesman, 73 E. Main, bds. 170½ West Main [b. 27 N. St. Paul
 Jackson Alfred (*Weld & Jackson*), 4 Arcade,
 Jackson Charles W. engineer, h. 5 Martin
 Jackson George E. carpenter, h. 53 Champlain
 Jackson George F. lawyer, 84 Power's bldgs. house 2 Prospect
 Jackson Harry (*H. A. Kingsley & Co.*), 112 E. Main, bds. Whitcomb House
 Jackson Isabella, nurse, house 76 Adams
 Jackson Jas. C. stone cutter, b. 107 North av.

HENRY C. WISNER,

WHITE CHINA DINING and TEA SETS, No. 33 STATE STREET.

- Jackson James H. hairdresser, 319 State, h. 2 S. Washington
 Jackson Jesse, caterer, h. 3 North Frances
 Jackson Joel, farmer, h. North av. n. Norton
 Jackson John, laborer, house 44 Howell
 Jackson John, hairdresser, 2 Railroad av. house do. [29½ Wadsworth
 Jackson John C. porter, 100 State, house
 Jackson Joseph, clerk, 78 State, h. 24 Gates avenue
 Jackson Joseph H. B. sculptor, 149 State, h. 62 Wilder
 Jackson Mary Mrs. house 231 Brown
 Jackson Micajah, farmer, h. Waring road n. Norton
 Jackson Robert, coachman, bds. 143 E. Main
 Jackson Samuel, hairdresser, 43 E. Main, h. 16 South Ford
 Jackson Sarah N. widow, h. 107 North av.
 Jackson Seba, widow, boards 5 Martin
 Jackson William, clerk, 4 W. Main, boards 170½ West Main
 Jacob Catharine, widow, boards 29 Kent
 Jacobi Sigmund, cutter, boards 83 Chatham
 Jacobowitz Augustus, paperhanger, house 65 Nassau
 Jacobs Barnard, peddler, house 175 North
 Jacobs Charles S. removed to Victor
 Jacobs Erastus N. removed from city
 Jacobs George W. house 123 Lake avenue
 Jacobs Gustave C. (*Jacobs & Hughes*), house 103½ East Main
 Jacobs Henry N. shoemaker, 77 North Water, house 15 Thomas
 Jacobs Homer, house 153 Alexander
 Jacobs John, carpenter, 193 North Clinton, house 66 Cypress
 Jacobs John, tailor, house 57 Kelly
 Jacobs John H. shoemaker, 108 St. Joseph, house St. Joseph n. Hayward park
 Jacobs John R. shoemaker, 87 N. Water, bds. St. Joseph near Hayward park
 Jacobs Maria, forewoman, h. 36½ S. St. Paul
 Jacobs Paul G. removed to Detroit, Mich.
 Jacobs Pauline Mrs. house 24 Hill
 Jacobs William, painter, house Ashland near Gregory [near N. Clinton
 Jacobs William, carpenter, house Hoeltzer
 Jacobs William W. student, University of Rochester, boards 29 South
 Jacobs & Hughes (*G. C. Jacobs and F. L. Hughes*), toys, &c. 164 West Main
 Jacobson Meyer, boards 54 Chatham
 Jacobus Charles H. clerk, b. 11 Saratoga av.
 Jacobus John, laborer, 54 Lyell, house 11 Saratoga avenue [11 Saratoga av.
 Jacobus John A. tinsmith, 266 State, boards
 Jacobus Margaret, widow, b. 11 Saratoga av.
 Jacobus Peter, teamster, 279 State, h. 343 do.
 Jacques T. S. salesman, 73 East Main, bds. 13 Stillson [bds. 118 Alexander
 Jager Johannes, student, Roch. Theo. Sem.
 Jager Charles, carpenter, house 7 Hollister
 Jager Frank, tanner, 87 N. Water, h. 13 Bay
 Jager George, tinsmith, 8 South St. Paul, house 42 Sanford
 Jager George, laborer, house 68 Kelly
 Jager John, laborer, 76 E. Main, h. 11 Hoeltzer
 Jager John, shoecutter, 55 Mill, h. 60 Clifton
 Jager John, laborer, 20 Court, h. 32 Gregory
 Jager, see Yager
 Jaggi Jacob, carriage maker, h. 144 Campbell
 Jagoe Alice, widow, boards 72 Champlain
 Jahn Aloise, watchman, house N. Clinton n. Clifford
 Jahn Henry, boat builder, house 1 Ashland
 Jehreis John, laborer, boards 2 Bond
 Jalkut Samuel, peddler, house r. 14 Vienna
 James A. whitewasher, house r. 32 West av.
 James Caroline M. clerk, b. 210 N. St. Paul
 James Darius W. roofer, house 123 Adams
 James Frederick C. boards 210 N. St. Paul
 James Frederick T. cigar manuf. 6 N. Water, house 72 Mt. Hope avenue
 James Henry A. stonecutter, 8 West avenue, house 3 George's park [N. St. Paul
 James Isaiah, clerk, N. Y. C. R. R. depot, h. 210
 James James J. carpenter, 93 Exchange, h. 37 South avenue
 James Jemima Mrs. house 50 Atwater
 James John, butcher, house Lake avenue n. Ridge road
 James John E. butcher, boards 37 South av.
 James Joseph, shoemaker, house 32 South
 James Mary Sister, domestic, St. Patrick's Orphan Asylum
 James Sarah, widow, bds. 41 S. Washington
 James Thomas Rev. house 80 Tremont
 James Thomas E. grocer, Clifton corner Frances, house do. [11 South
 James William H. carrier, Post Office, house
 James Wm. T. broom manuf. 5 North Ford, house 79 Allen [4 Reynolds
 Jameson Albert L. bookkeeper, Gas Works, b.
 Jameson Geo. J. expressman, b. 4 Reynolds
 Jameson I. H. widow, house 4 Reynolds
 Jameson Joseph B. bookkeeper, 10 S. Water, boards 41 Lancaster
 Jamieson Andrew R. moulder, Brown's race near Furnace, house 45 Myrtle
 Janeck Charles L. mason, house 25 Henry
 Janeck Michael, laborer, boards 23 Henry
 Janes Abbie N. widow, house 48 South av.
 Janes Alvin, house 159 Alexander
 Janes Asel, machinist, house 24 East
 Janes Elizabeth, widow, house N. St. Paul near lower falls [Goodman
 Janes Henry, laborer, house Jennings near
 Janes Julian A. agent, boards N. St. Paul near lower falls [cor. Wilder
 Janes Wm. P. surveyor, house Monroe av.
 Janes William S. lawyer, house 5 Cobb
 Janes Wm. T. shoemaker, 2 Mumford, house 165 West Main [b. 48 South av.
 Janes Willis H. photographer, 55 East Main,
 Jannaske Anna, widow, house 4 Ward
 Jannck Frederick, laborer, house 32 Henry
 Jannck John, mason, house 21 Oakman
 Jansen Abraham, mason, b. 18 Huntington
 Jansen Arend, bookkeeper, 65 North Water, boards 13 Pleasant
 Jansen Jacob, mason, house 18 Huntington
 Jaquith Addison B. foreman, 44 Exchange, house 18 Sibley's block
 Jaquith Elbridge A. shoe manufacturer, 44 Exchange, house 29 South Clinton

Jaquith Harriet P. widow, house 82½ State
 Jardine Fanny, stitcher, boards 3 Genesee
 Jardine Jessie, seamstress, boards 38 Stillson
 Jardine John, laborer, house 3 Genesee
 Jardine John jr. clerk, 128 East Main, boards
 3 Genesee
 Jardine Mary Miss, stitcher, bds. 3 Genesee
 Jarrard Robert, student, 158 Powers' bldgs.
 house Pennsylvania av. n. Fourth av.
 Jarvis Frederick, removed to Fairport
 Jarvis Geo. W. porter, 74 Mill, h. 34½ John
 Jarvis Henry, laborer, h. 14 Kent near R. R.
 Jarvis Lucina, widow, house 10 Scio
 Jarvis William, tailor, house 12 Dover
 Jarvis William jr. tailor, boards 12 Dover
 Jauchzi Andrew, laborer, house Parkland
 Jauchzi George, tanner, 130 Front, house 274
 North St. Paul
 Jauchzi Philip, whipmaker, bds. 48 Hanover
 Jayne Frank A. clerk, 32 E. Main, h. 24 East
 Jeal Carrie domestic, bds. 216 University av.
 Jefferis John H. carpenter, 37 King, h. do.
 Jeffery Hezekiah, laborer, b. 150 N. St. Paul
 Jeffords Chas. A. contractor, h. Broadway
 near Alexander [Alexander
 Jeffords Elsie, widow, house Broadway cor.
JEFFRES JOHN H. lawyer, 118 Powers'
 bldgs. house 49 Park avenue cor. Arnold
 park.—See page 512 [Fitzhugh
 Jeffrey Agnes, teacher of painting, bds. 83½
 Jeffrey Arthur H. hairdresser, house 2 South
 Washington
 Jeffrey Elizabeth Mrs. boards 46 Jay
 Jeffrey Happy S. widow, house 10 Weld
 Jeffrey Jehiel B. removed to Detroit, Mich.
 Jeffrey Nathan C. polisher, bds. 78 Tremont
 Jeffrey Pauline Miss, house 16 South Ford
 Jeffrey Roswell D. house 41 Meigs
 Jeffreys Anna, widow, boards 415 Brown
JEFFREYS CHARLES V. undertaker and
 coffin warehouse, 125 State, house 46 Jay.
 —See page 608
 Jeffreys J. M. Mrs. widow, bds. 32 Atwater
 Jeffreys Lemuel A. bookkeeper, 125 State,
 boards Brackett House [Genesee
 Jeffries Alfred, lime burner, h. Bismarc near
 Jehle Ottmar, tailor, 86 South St. Paul, h. do.
 Jehlenn Dominick, shoemaker, 92 State, h.
 72 Childs [b. 94 N. Clinton
 Jehrig John, cabinetmaker, 69 N. St. Paul,
 Jendreau Joseph, shoemaker, b. 27 Galusha
 Jendreau Julius, house 27 Galusha
 Jendreau Saurar, upholsterer, b. 27 Galusha
 Jenner Elizabeth, dressmaker, 36 Andrews,
 house do.
 Jenkins Charles, machinist, b. 66 Kent
 Jenkins Emily, widow, house 66 Kent
 Jenkins George W. agent, New Jersey Mut-
 ual Life Ins. Co. 18 W. Main, house 29
 University avenue [Fitzhugh
 Jenkins Henrietta Miss, dressmaker, house 28
 Jenkins James B. hairdresser, 34 Exchange,
 house 79 Atkinson
 Jenkins John, boards 66 Kent
 Jenkins Thomas B. nurseryman, 1 East pk.
 house 47 Asylum
 Jenkinson Eliza, widow, house 65 Orange
 Jenkinson John, house 21 North Frances

Jenkinson Joshua, sashmaker, 13 Warehouse,
 house 170 Orange [65 Orange
 Jenkinson Samuel, machinist, 124 Mill, bds.
 Jenkinson William H. letter carrier, Post
 Office, house 216 Brown
 Jenneahn Christian, laborer, house Good-
 man near Bay
 Jennett James, removed to Montreal, Can.
 Jennings Adelia, boards 54 Scio
 Jennings Agnes P. widow, bds. 60 Sophia
 Jennings Betsey Miss, boards 51 S. Clinton
 Jennings Bridget, domestic, boards East av.
 corner Wilder place
 Jennings Caroline, widow, h. 51 S. Clinton
 Jennings Carrie L. boards 51 South Clinton
 Jennings Charles E. painter, 3 Canal, house
 57 Prospect [17 Frank
 Jennings Conrad L. clerk, 36 Exchange, bds.
 Jennings Cornelia R. teacher Whitney School
 No. 17, house 74 Caledonia avenue
 Jennings Daniel J. coachmaker, 3 Canal, h.
 56 Prospect
 Jennings Edward, carriage trimmer, 3 Canal,
 house 74 Caledonia avenue
 Jennings Egbert B. (*Davis, Jennings & Co.*),
 Jefferson Mills, bds. 51 S. Clinton
 Jennings Elvira S. Mrs. house 51 Monroe av.
 Jennings Emeline, widow, h. 43 South Union
 Jennings George E. (*Erickson, Jennings &*
Mumford), 25 State, house 53 S. Clinton
 Jennings Henry M. farmer, h. Goodman near
 Webster road
 Jennings Jas. laborer, h. Mansion n. Magnolia
 Jennings James jr. removed to Penn Yan
 Jennings John, laborer, h. Field n. Monroe
 Jennings John, carriagemaker, 3 Canal, bds.
 82 West avenue [Brown block
 Jennings Joseph, stitcher, 3 Canal, house 40
 Jennings Thomas, carriage painter, 277 State,
 boards Magnolia c. Mansion
 Jennings Wm. H. carpenter, h. 42 Chatham
 Jennings Whalen H. farmer, bds. Goodman
 near Webster road
 Jenny Benedict, carpenter, h. 106 South av.
 Jenny John, saloon, 43½ N. Clinton, h. do.
 Jermy Henry, cartman, house 106 Adams
 Jerome Charles W. farmer, house 50 Frank
 Jerome Mary Sister, teacher, St. Patrick's
 Orphan Asylum [N. J.
 Jerome Walter W. removed to Mont Clair,
 Jervis Asahel H. house 66 Sanford
 Jess Christian, laborer, house 22 Wadsworth
 Jesserer Aloise, grocer, 85 Hunter, house do.
 Jesserer Andrew, packer, 16 Exchange, bds.
 85 Hunter [Hunter
 Jesserer Lewis, carpenter, h. Frances near
 Jester Chas. J. artist, boards 103½ E. Main
 Jettles Larry A. (*Jettles & Leseritz*), boards
 44 Franklin
 Jettles & Leseritz (*H. A. Jettles and F. S. Les-*
eritz), jewelers, 107 Powers' bldgs.
 Jewett David S. clerk, 98 E. Main, boards 44
 North avenue
 Jewett E. teacher, Brighton School, No. 23,
 Bates n. Bowen, house at Brighton
 Jezard Elizabeth A. stitcher, boards Oak c.
 Lind
 Jezard Henry, laborer, house Oak cor. Lind

HENRY C. WISNER,

CUT AND PRESSED GLASS TABLE WARE,
No. 33 STATE STREET.

Jingling Catharine, widow, bds. 81 Pinnacle avenue
 Jobs Catharine, housekeeper, 42 Frank
 Joeckle Jacob, switchman, John street, house 16 Syke [avenue]
 Joerger Felix A. stonecutter, b. 30 Concord
 Joerger Sophia, widow, h. 30 Concord avenue
 John Nicholas, boards 39 Wilder
 Johns Franklin, whipmaker, Allen corner N. Washington, house 50 Orchard
 Johns George W. druggist, 110 North Clinton, house 33 Marietta
 Johns Jacob, saloon, 60 West av. house do.
 Johns John, mason, house 14 Hope
 Johns Josephine M. Miss, boards 72 Oak
 Johns Michael, boards 14 Hope
 Johns Rachel, widow, boards 99 Tremont
 Johnson Adaline L. widow, h. 311 E. Main
 Johnson Adelia B. hairworker, bds. 35 Oak
 Johnson Alfred, laborer, boards 43 Kent
 Johnson Alice Mrs. bds. r. 23 Mt. Hope av.
JOHNSON ALMERON J. & CO. (*J. I. Robins jr.*), shoe manufacturers, 4 Allen, house 78 Plymouth av.—See page 664
 Johnson Andrew, plasterer, house 318 State
 Johnson Andrew J. foreman, 4 Allen, house 172 Brown
 Johnson Andrew L. removed to Castile
 Johnson Ann, widow, bds. 2 Brown's alley
 Johnson August, machinist, house 57 Joiner
 Johnson Augustus, engineer, Erie Railway, house 2 Adams
 Johnson Calvin, house 6 Charlotte [16 Kent
 Johnson Caroline S. Miss, dressmaker, house
 Johnson Catharine, widow, h. 1 Clinton pl.
 Johnson Charles, groom, boards 105 Mill
 Johnson David C. foreman, 3 Otsego, house 209 State [York n. Wentworth
 Johnson Edward P. salesman, house New
 Johnson Ellen, widow, boards 19 Kent
 Johnson Eva M. teacher, boards 86 Frank
 Johnson Ferdinand, blacksmith, house 119 Champlain
 Johnson Franklin A. (*Smith, Johnson & Co.*), 115 Arcade, house 1 Evergreen park
 Johnson George E. agent, 3 Canal, h. 102½ East Main [h. Brown c. Allen
 Johnson George L. hackman, 15 Fitzhugh,
 Johnson Harriet Mrs. h. 28 Plymouth av.
 Johnson Harvey B. student, University of Rochester, boards 198 Alexander
 Johnson Henry, driver, house 104 Allen
 Johnson Henry, laborer, h. Webster road n. Culver
 Johnson Henry A. sawyer, house 5 First
 Johnson Henry G. hairdresser, 148 W. Main, house do.
 Johnson Henry M. polisher, h. 8 Munger
 Johnson Hugh, policeman, City Hall, house 16 Favor [n. Pinnacle av.
 Johnson Hugh A. bookkeeper, h. Caroline
 Johnson Isaac, finisher, 74 State, boards 28 Bolivar [toga av.
 Johnson Isaac, conductor, h. Costar n. Sara-
 Johnson Isaac A. peddler, 141 North Water, house 12 Tyler [do.
 Johnson Jacob, market, Reynolds c. Cady, h.
 Johnson Jas. steam laundry, h. 31 Alexander

Johnson James, finisher, house 54 Allen
 Johnson James A. policeman, City Hall, h. 323 Brown [Plymouth av.
 Johnson James E. clerk, 4 Allen, boards 78
 Johnson James H. laborer, house 16 S. Ford
 Johnson Jane Miss, house 104 Exchange
 Johnson Jane E. widow, house 5 Vienna
 Johnson Janette, widow, house 27 Charlotte
 Johnson Jeremiah P. clerk, house 101 North
 Johnson John, stone mason, house 45 Lyell
 Johnson John, boards 46 Kent
 Johnson John T. porter, boards 113 Mill
 Johnson Joseph W. laborer, house 84 Platt
 Johnson J. Greig, salesman, 24 State, boards 126 Fitzhugh
 Johnson Lyman, constable, house 7 Hill
 Johnson Mary, widow, house 135 S. St. Paul
 Johnson Mary, widow, boards 27 Gibbs
 Johnson Mary Mrs. proprietor Niagara House, 154 State
 Johnson Mary A. widow, house 16 S. Ford
 Johnson Mary J. stitcher, boards 43 Kent
 Johnson Nancy M. widow, boards 3 East av.
 Johnson Nannie, widow, boards 4 Adams
 Johnson Ole, house 18 Glasgow
 Johnson Oliver, teamster, boards 12 Tyler
 Johnson Reuben, house 86 Frank
 Johnson Rosa A. widow, house 43 Kent
 Johnson Rudolph, blacksmith, 3 Canal, house 79 Hunter
 Johnson Samuel, mason, house 13 Tracy pk.
 Johnson Seldon, bartender, 91 Mill, boards Wimble House
 Johnson Sophia, house 39 Gibbs
 Johnson Spencer, blacksmith, Mill n. Brown, boards 209 State
 Johnson Susan, saloon, 70 Exchange, h. do.
 Johnson Thomas L. (*McLean & Johnson*), 27 Arcade, boards 15 Pleasant
 Johnson Truman B. (*Curran & Johnson*), h. at Seneca Falls [place
 Johnson Wm. painter, 14 Stone, b. 1 Clinton
 Johnson Wm. deceased November 1875
 Johnson Wm. house 60 Oak
 Johnson Wm. hostler, Livingston place cor. Troup, house 22 Caledonia avenue
 Johnson Wm. foreman, 15 Fitzhugh, boards Wimble House
 Johnson Wm. H. whipmaker, Allen cor. N. Washington, house 9 Romeyn
 Johnson Wm. H. mason, house 33 Hill
 Johnson Wm. T. removed to Brooklyn, L. I.
 Johnson Zephyr, shoemaker, 4 Allen, house 30 Galusha [b. 91 Scio
 Johnston Andrew, shoemaker, 44 Exchange,
 Johnston B. Birtus, clerk, h. 15 Edinburgh
 Johnston Clark, 30½ S. St. Paul, house East avenue near Vick park [State
 Johnston Daniel L. (*Rowley & Johnston*), 41
 Johnston Isabella, widow, boards 42 Lowell
 Johnston James, clerk, 8 Exchange place, b. 9 Lake avenue [9 Lake av.
 Johnston John, clerk, State c. Smith, boards
 Johnston Lottie Mrs. house 26 Allen
 Johnston Margaret, dressmaker, house 15 Edinburgh [Smith, h. 9. Lake av.
 Johnston Robert, flour and feed, State cor.
 Johnston Sarah S. b. Culver n. Schanck av.

A. R. PRITCHARD & LIKLY,

TRUNKS AND BAGS, WHOLESALE AND RETAIL, No. 78 STATE STREET.

Johnston Thomas, farmer, house Culver n. Schanck avenue
 Johnston Thomas S. (*Sibley, Lindsay & Curr*), 73 East Main, boards Whitcomb House
 Johnston Washington G. 87 N. Water, house 7 Scio
 Johnston Wm. K. clerk, Model Mills, South Water, b. 9 Lake av. [ton av.
 Joiner Martin, grocer, 297 State, h. 15 Ful-
 Joiner Mortimer C. clerk, 297 State, boards 15 Fulton avenue
 Joint Frank, teamster, Frost av. c. Olean, h. Scottsville r'd at Rapids [b.24 Franklin
 Jone Barnabas, sexton, St. Joseph's church,
 Jones Adelaide M. boarding house 58 Frank, house do.
 Jones Albert, waiter, 119½ E. Main, bds. do.
JONES ALBERT J. Rochester Brackett Works, foot Aqueduct, and picture store 22 E. Main, h. 32 Madison.—*See page 648*
 Jones Allen C. removed from city
 Jones Amanda, widow, house 66 Asylum
 Jones Anna, widow, house 13 Lancaster
 Jones Anna widow, house 226 West Main
 Jones A Elizabeth Miss, tailoress, boards 323 Brown
 Jones Barbara A. Mrs. boards 187 State
 Jones Benedict, laborer, house 323 Brown
 Jones Bert, author, boards 6 Orange
 Jones Beverley W. bookkeeper, C. B. Hill's, South Water, house 39 Chestnut
 Jones Caroline A. widow, house 85 Chatham
 Jones Caroline B. house 27 Chestnut
 Jones Caroline B. music teacher, boards 62 Caledonia avenue
 Jones Cassius O. house 37 Mt. Hope avenue
 Jones Charles P. agent, house 6 Orange
 Jones Charlotte A. Miss, boards 116 West av.
 Jones Christopher, laborer, house 2 Zimmer
 Jones Cordelia M. Miss, h. 41 University av.
 Jones C. F. Mrs. house 79 Sibley's block
 Jones David, laborer, house 1 School alley
 Jones Edward, 16 S. St. Paul, and (*Goggin & Jones*), boards Whitcomb House
 Jones Edward A. clerk, 38 S. St. Paul, bds. 68 do. [h. Clifton n. Summer
 Jones Edwin A. salesman, Hunter c. Olean,
 Jones Egbert, carpenter, Brown c. Jones, h. 155 Brown
 Jones Elijah W. boards 41 University av.
 Jones Eliza, widow, house 187 State
 Jones Eliza Jane, widow, house 44 Chatham
JONES EZRA & SON (*J. Emory Jones*), foundry, Brown's race foot Furnace, h. 72 Allen.—*See page 683*
 Jones Frank, clerk, 107 Plymouth av. bds. 62 Caledonia av. [Mich.
 Jones Frederick S. removed to Grand Rapids,
 Jones George H. shoemaker, 91 N. Water, boards 13 Pearl
 Jones George W. boards 187 State
 Jones George W. boards Waverley House
 Jones Hannah M. widow, house 14 Elm
 Jones Harris S. shoemaker, house 13 Pearl
 Jones Harry C. (*Jones & Sugru*), 43 State, h. 188 East Main
 Jones Henry, painter, house 5 Hamburg
 Jones Henry, clerk, house 10 Erie

Jones Hiram T. nurseryman, Locust n. Ful-
 ton av. boards at Greece
 Jones Horace, surveyor, 57 State, b. 187 do.
 Jones Horatio P. mason, house 12 Hickory
 Jones Hubbard W. grocer, 38 South St. Paul, b. 68 do.
 Jones Humphrey, carpetweaver, 298 Monroe avenue, house do.
 Jones James, laborer, boards 68 Exchange
 Jones James, boards 44 Chatham
 Jones James, house 3 Oak
 Jones James B. salesman, b. 95 South av.
 Jones Jessie A. widow, h. 106 South avenue
 Jones John B. insurance, 62 E. Main, b. 95 South avenue [Greece
 Jones John B. (*Jones & Palmer*), house at
 Jones John F. trimmer, 3 Canal, boards 46 Tremont [Rhine
 Jones John H. slater, 90 East Main, house 10
 Jones John J. scalemaker, house 38 Marshall
 Jones Jonas, physician, 116 West av. h. do.
 Jones Julia M. widow, house 147½ East Main
 Jones Juliette, artist, boards 147½ East Main
 Jones J. Emory (*E. Jones & Son*), house 59 North St. Paul [St. Paul
 Jones Lafayette M. brakeman, h. 103 North
 Jones Laura, widow, house 11 Prospect
 Jones Mary, house 20 Monroe av.
 Jones Mary A. artist, 75 East Main, bds. do.
 Jones Mary E. Miss, bds. 95 South avenue
 Jones Mary J. house 48 Orchard
 Jones Minerva Mrs. house Bismarc
 Jones Orson B. superintendent, 53 E. Main, house 87 Mt. Hope avenue
 Jones Percival K. removed to New York
 Jones Philip T. saloon, 132 Front, h. 74 Oak
 Jones Rachel J. Mrs. nurse, h. 62 Caledonia avenue [House, boards 12 Dean
 Jones Reuben D. clerk of the court, Court
 Jones Rowland, coffin maker, 22 S. St. Paul, house 7 Hudson
 Jones Samuel, clerk, 155 West Main, b. do.
 Jones Sarah, millinery, 298 State, house do.
 Jones Sarah E. Mrs. house 321 State
 Jones Seth C. surveyor, boards Erie 10
 Jones Thomas, hairdresser, 2 Railroad av. b. 104 Exchange [Temperance bldgs.
 Jones Thomas, hackman, 83 Front, house 53
 Jones Thomas W. Mrs. widow, b. 116 West avenue [house 141 Hunter
 Jones William, baker, 104 Plymouth avenue,
 Jones William H. (*McConnell & Jones*), 50 Exchange, house 128 Alexander
 Jones William H. (*Forsyth & Co.*), 5 Andrews, boards 38 Marshall
 Jones W. Martin, lawyer, and (*McPhail & Jones*), 39 Arcade, h. 52 S. Union
 Jones & Palmer (*J. B. Jones and B. R. Palmer*), nursery, Locust n. Fulton av.
JONES & SUGRU (*H. C. Jones and E. J. Sugru*), Singer sewing machines, 43 State.—*See page 549*
 Jordan Ann, widow, house Spring c. Favor
 Jordan Ann Miss, milliner, bds. 50 Bolivar
 Jordan Charles A. student, bds. 79 Ontario
 Jordan Charles M. engineer, N. Y. C. R. R. house 79 Ontario
 Jordan Christopher, deceased, March 14, 1876

- Jordan Christopher Mrs. widow, house 29 Savannah
- Jordan Edwin E. (*Williams & Jordan*), 96 E. Main, house 29 Savannah
- Jordan Elizabeth, widow, house 50 Bolivar
- Jordan Fanny A. widow, house 36 S. Union
- Jordan Irving H. photographer, b. Farmer's Hotel [42 South Union]
- Jordan James A. lawyer, 37 Arcade, boards
- Jordan John A. house 46 William
- Jordan Julius C. contractor, b. 29 Savannah
- Jordan Matthew, plasterer, 16 Stone, bds. 38 Allen [Monroe avenue]
- Jordan Wm. C. clerk, b. Maple place near
- Jordan William L. constable, house Maple place near Monroe avenue
- Jory Mary Miss, house 54 Atwater
- Jory Sibella Miss, house 54 Atwater
- Joseph Johanna Mrs. saloon, 75 Front, h. do.
- Joseph Mary, removed to Geneva
- Joseph Rosa Miss, house 280 North Clinton
- Joseph William, saloon, 73 Front, house do.
- Josiah Sister Mary, teacher Holy Family school, Jay cor. Ames, boards 265 Jay
- JOSLIN THOMAS M.** milk and cream dairy, 156 State, h. 165 do.—*See page 571*
- Joslyn Eugene A. clerk, 34 West Main, h. 3 Phelps avenue
- Joslyn John H. clerk, boards 1 Joslyn park
- Joslyn Maria M. widow, house 1 Joslyn park
- Joslyn Matthew H. real estate, h. 29 Conkey avenue
- Joy Clarence E. clerk, house 101 East Main
- Joy Lewis S. carpenter, house 98 South av.
- Joy Linus, gardener, house 15 Goodman
- Joy Sidney, clerk, 73 E. Main, b. 98 South avenue
- Joyce Hattie, seed packer, b. 212 Alexander
- Joyce John, laborer, house 103 Francis
- Joyce Keziah, house 212 Alexander
- Joyce Patrick (*Joyce & Moran*), h. 27½ Platt
- Joyce Thomas, laborer, house 189 Alexander
- Joyce & Moran (*P. Joyce and A. J. Moran*), undertakers, 206 West Main
- Joyes Benjamin, coffee roaster, 11 W. Main, house 68 North Union
- Joyes Frederick E. morocco dresser, 37 N. Water, boards 189 Alexander
- Joyes Thomas, boards 53 Pinnacle avenue
- Judd Ethan A. removed to Ontario, Canada
- Judd Lucien, laborer, house 73 Hunter
- Judd Ralph C. shoemaker, 83 North Water, house 22 Pryor [avenue]
- Judge Andrew, produce dealer, b. 63 North
- Judge Patrick, asst. supt. 53 East Main, h. 52 Andrews
- Judge Susannah B. Miss, boards 109 Frank
- Judson Albert, engineer, N. Y. C. R. R. h. 16 Elm [Lake avenue]
- Judson Charles B. clerk, 116 Mill, boards 70
- Judson James S. (*Judson & Co.*), house 93 Mt. Hope avenue
- Judson Junius & Son (*J. L. Judson*), governor manufs. 116 Mill, house 70 Lake av.
- Judson Julia, widow, bds. Goodman near Monroe avenue
- Judson J. Lee (*J. Judson & Son*), 116 Mill, h. 84 Lake avenue
- Judson William W. (*Judson & Co.*), house 52 Meigs
- Judson & Co. (*W. W. and J. S. Judson*), fish pole manufs. 119 N. Water
- Julian Lawrence, baggageman, N. Y. C. depot, house 7 Weld [boards do.]
- Julian Wm. gardener, Nazareth Convent,
- Jumph Jacob A. clerk, Monroe av. c. South Union, h. 21 Broadway
- Jund Gregory, laborer, h. Lincoln n. Clifford
- June Charles R. lamp cleaner, b. 43 Prospect
- Junker William G. market, 220 West Main, house 52 Gregory
- Jurgensen Carl, student, Rochester Theological Seminary, boards 66 Weld
- Justice Ann J. widow, house 5 Romeyn
- Justice Frances, widow, h. Walnut cor. Jay
- Justice Robert, grocer, 146 Brown, boards 13 Romeyn [8 George's park]
- Justice William, silver plater, 3 Canal, h.
- Justine Mary Sister, teacher St. Bridget's School, Hand, b. Jay c. Frank
- KAEFER FREDERICA MRS.** h. 48 Weeger n. Henry
- Kaemmer Peter, shoemaker, h. 5 Webster
- Kahbing John, laborer, house Ulm fear Bay
- Kahler Frederick W. butcher, bds. 216 Front
- Kahler Jacob, tool grinder, 120 Mill
- Kahler Michael, laborer, Exchange opposite Troup, bds. Hague near railroad
- Kahler, see Kohler and Koehler
- Kahn Jacob, peddler, boards 45 Buchan pk.
- Kahr George, laborer, h. 128 Pinnacle av.
- Kain James, laborer, boards 33 Frank
- Kaiser Martin, clerk, 76 State, bds. 36 North Washington [house 37 Wilder]
- Kaiser August, carpenter, Brown cor. Jones,
- Kaiser Caspar, driver, boards 2 Sycamore
- Kaiser Charles, stock keeper, 24 State, bds. 32 Ward
- Kaiser Frederica, widow, house 22 Holland
- Kaiser John, hostler, 96 Fitzhugh, bds. do.
- Kaiser John, removed to France
- Kaiser Joseph, laborer, boards 20 Stone
- Kaiser Michael, tanner, h. Moulson near Jay
- Kaiser, see Keiser [Mt. Hope avenue]
- Kalb Francis J. (*Kalb, Hahn & Co.*), h. 65
- Kalb Frank, shoemaker, S. St. Paul corner Griffith, house 132 Pinnacle avenue
- KALB, HAHN & CO.** (*F. J. Kalb, C. Hahn and C. W. Rampe*), leather and findings, 5 Mumford.—*See page 667*
- Kalb John, varnisher, 15 N. Water, boards Miller near Bay [74 Mt. Hope av.]
- Kalb John, leather dealer, 6 North Water, h.
- Kalb John jr. boards 74 Mt. Hope avenue
- Kalb John B. laborer, bds. 203 Pinnacle av.
- Kalb John J. tanner, h. 74 Mt Hope avenue
- Kalb Joseph, clerk, 6 N. Water, b. 74 Mt. Hope avenue [Miller near Bay]
- Kalb Lawrence, finisher, 15 N. Water, bds.
- Kalb Rosana, widow, h. Miller near Bay
- Kalbfleisch Edwin A. clerk, b. 7 Reynolds
- Kalbfleisch John II. music teacher, 121 Powers' bldgs. h. 7 Reynolds [b. 7 Reynolds]
- Kalbfleisch J. Clifford, clerk, 14 Mumford,
- Kaler Jacob, teamster, h. Martin n. Lowell

- Kall Christopher W. moulder, 8 Hill, h. 187
 Jay [3 Galusha
- Kall John, carver, Jay cor. Erie Canal, house
 Kallusch Frederick W. shoemaker, River n.
 S. St. Paul, house 7 Holland
- Kallusch Henry, tailor, house 87 Cypress
 Kallusch Samuel, mason, house 45 Cypress
 Kallush Charles (*Wichmann & Kallush*), 7
 South avenue, boards 45 Cypress
- Kalmbach Jacob, teamster, house 10 Maria
 Kalmbach Louis, teamster, house Maria near
 Clifford
- Kalmbacher Conrad, tailor, house 7 Edward
 Kalmbacher Kasimer, tailor, 105 Hudson, h.
 134 do.
- Kaltenbach Andrew, house 6 Pleasant
 Kalwas Albert H. laborer, house 25 Henry
 Kamb Jacob, flour packer, Flour City Mills,
 boards 19 Hoelfer
- Kamb Michael, mason, house 132 Hudson
 Kambeitz Lawrence, h. Bay cor. Goodman
 Kammer Henry, cutter, 70 Mill, boards 4
 Goodman [exander park
- Kammer Jacob, cutter, 70 Mill, house 5 Al-
 Kammer John N. cutter, 70 Mill, house 18
 Marshall [Harvard
- Kammer Joseph, cutter, 24 State, house 14
 Kammer Philip, cutter, 24 State, house 4
 Goodman [East avenue
- Kammer Wm. J. machinist, bds. Goodman n.
 Kammerer Leonard, rag picker, 111 Mill, h.
 322 Brown
- Kammerloher Andrew, warehouseman,
 Model Mills, h. 26 North York
 Kampf Joseph, blacksmith, 120 Mill
 Kanane Michael, saloon, 59 West av. boards
 Union Hotel
- Kane Ann, widow, house 7 Elizabeth place
 Kane Annie Miss, b. University av. n. Culver
 Kane Annie Miss, boarding house, 38 Platt,
 house do.
- Kane Charles, laborer, house 139 Frank
 Kane Christopher, shoemaker, 4 Allen, house
 51 West Maple
- Kane Elizabeth, widow, boards 44 Thompson
 Kane Elizabeth, widow, h. 39 Brown's alley
 Kane James, house 59 Lancaster
 Kane James jr. grocer, 21 Monroe av. h. do.
 Kane John, laborer, house Sibley n. Bates
 Kane John (*James S. Graham & Co.*), Mill
 near Factory, house 2 Ambrose
- Kane John H. sawmaker, b. 39 Brown's al.
 Kane Julia Miss, boards 38 Platt
 Kane Libbie M. teacher, Franklin school,
 No. 6, boards 139 Frank
- Kane Mary F. widow, boards 84 Hudson
 Kane Mary J. dressmaker, bds. 51 University
 avenue [h. 19 Harrison
- Kane Michael, cabinetmaker, 155 N. Water,
 Kane Michael, shoemaker, North Water c.
 Andrews, house 110 Bartlett
- Kane Patrick, cattle policeman, house 45
 Tremont
- Kane Patrick jr. thermometer maker, 8 Hill,
 boards 45 Tremont
- Kane Perry, laborer, h. Plymouth av. n. rapids
 Kane Samuel H. machinist, Clinton Mills, b.
 139 Frank
- Kane Sarah, bookkeeper, Clinton Mills, bds.
 139 Frank
- Kane Thomas, shoemaker, North Water cor.
 Andrews, house 6 Lime [87 Adams
- Kane Thomas, coachman, 40 Spring, house
 Kane Thomas, removed from city
 Kane Thomas W. boards 39 Brown's alley
 Kane William, removed to Philadelphia
 Kane, see Cain and O'Kane
- Kanhauser Wilhelmine, widow, house 316
 North Clinton
- Kanhooyer Wm. music teacher, h. 86 Atwater
 Kannagh Ellen, widow, house Cataract near
 North St. Paul
- Kannagh James W. deceased June, 1875
 Kannan James, laborer, house 21 Smith
 Kany Anthony, laborer, h. Goodman n. Bay
 Kapler Sebastian, cooper, h. 113 Jay [do.
- Kapp Philip, shoemaker, 291 N. Clinton, h.
 Karber Frederick, watchman, 17½ Hawkins
 Karg Catharine, widow, bds. 40 N. Frances
 Karg Engelbert, engineer, b. 40 N. Frances
 Karg Gebhard, tailor, 172 Jay, house do.
 Karg George, laborer, h. Union alley near
 Andrews [Mt. Hope av.
- Karg George, butcher, 104 W. Main, h. 105½
 Karges Wm. milkman, h. 203 Pinnacle av.
 Karle John J. music teacher, b. 58 S. St. Paul
 Karle Juliana, saloon, 58 S. St. Paul, h. do.
 Karle Michael, carpenter, house 205 North
 Karle Michael, laborer, house 27 Sanford
 Karle William (*Ennecker & Karle*), 35 State,
 boards 58 South St. Paul
- Karles John, laborer, r. 144½ Mt. Hope av.
 Karnisky Theodore, sawyer, Jay corner Erie
 canal, house Lime cor. Childs
- Karp Anthony (*J. Karp & Sons*), b. 39 Rauber
 Karp Eugene (*J. Karp & Sons*), b. 39 Rauber
 Karp Frank, laborer, house 53 Sanford
 Karp Jacob jr. (*J. Karp & Sons*), h. 26 Rauber
- KARP JACOB & SONS** (*J. jr., Eugene,
 and Anthony Karp*), slate roofers, 39
 Rauber, house do.—*See page 642*
- Karp Julius, painter, boards 53 Sanford
 Karp Michael, slater, house 34 Hoeltzer
 Karpeles S. jeweler, boards 6 Clinton place
 Karweick John, mason, house 25 Pryor
 Karweik John, laborer, house 12 Widman
 Karweik John, teamster, boards 25 Henry
 Kasbom Charles, laborer, h. Lewis n. Diem
 Kasbom Frederick, laborer, 117 N. Clinton,
 house Lewis near Diem [av.
- Kasborn Laurence, laborer, h. 196 Pinnacle
 Kase Charles, clerk, 267 Plymouth av. bds.
 330 Brown [330 do.
- Kase George, hairdresser, 227 Brown, boards
 Kase Gertrude Mrs. widow, house 330 Brown
 Kase John, brewer, rear 125 West Maple, h.
 Ames n. West Maple [127 W. Maple
- Kase John B. carpenter, 14 St. Joseph, house
 Kase John E. grocer, 267 Plymouth av. h. do.
 Kase Joseph, tinsmith, boards 330 Brown
 Kase Nicholas, grocer, 108 Orange, house 35
 Whitney
- Kase Peter, grocer, 7 Wilder, house do.
 Kase Valentine, hairdresser, 7 Wilder, house
 34 do. [Miller near Bay
- Kasmann Adam, cabinetmaker, 2 Hill, house

Kassell Anthony H. hack stable, h. 26 Oak
 Kassell Joseph, hackman, house 36 Frances
 Kassmann Richard, laborer, house Lewis n.
 Mt. Vernon av. [h. Clifford n. Hudson
 Kastner Antony, stonecutter, 54 Fitzhugh,
 Kastner Melchior, stonecutter, 22 West av.
 house 134 Hudson
 Kate Michael, laborer, house 43 Scrantom
 Katel Frederick, hostler, 68 Plymouth av.
 boards do. [avenue
 Kating James, laborer, h. Stanley n. South
 Katz Abraham J. agent, 36 Mill, bds. 5 Elm
 Katz Adolph B. clerk, 40 State, bds. 11 Pitt
 Katz Jacob, produce, 181 E. Main, house 38
 North avenue
 Katz Joseph, oil dealer, house 5 Elm [Jay
 Katzenstein Joseph, laborer, house Ames n.
 Katzky William, cigarmaker, h. 37 Joiner
 Kaufman Bernardt, removed to Buffalo
 Kaufman Caroline, widow, house 45 Atwater
 Kaufman Christopher, laborer, 8 Hill, house
 3 Railroad alley [9 Griffith
 Kaufman Isaac, foreman, 55 S. St. Paul, h.
 Kaufman Jacob, restaurant, 42 Allen, h. do.
 Kaufman Joseph, carpenter, house 37 Hill
 Kaufman Leander W. (*Kaufman & Felsing*),
 house Frank near Jones avenue
 Kaufman & Felsing (*L. W. Kaufman and
 John A. Felsing*), liquors, 170 W. Main
 Kaut Marx, carpenter, house Mt. Vernon av.
 near Cayuga place [29 N. Frances
 Kavanagh Bernard, millwright, 127 Mill, b.
 Kavanagh Dennis, clerk, 14 Exchange, house
 27 N. Frances [Brown
 Kavanagh Francis P. toolmaker, house 342
 Kavanagh George, toolmaker, b. 342 Brown
 Kavanagh James, bridge builder, house rear
 11 Caledonia avenue
 Kavanagh Jane E. Miss, stitcher, bds. 163½
 Atkinson [344 Brown
 Kavanagh John, clerk, 111½ N. Water, bds.
 Kavanagh John D. laborer, h. 29 N. Frances
 Kavanagh John L. clerk, boards 102 Mill
 Kavanagh Mary Mrs. boarding house, 33
 Frank
 Kavanagh Mary A. milliner, bds. 37 Frank
 Kavanagh Michael, laborer, house 33 Frank
 Kavanagh Michael, blacksmith, house 127
 Adams
 Kavanagh Michael, laborer, house 244 Ply-
 mouth avenue
 Kavanagh Patrick, mason, h. 131 S. St. Paul
 Kavanagh Thomas, boards 10 Julia
 Kavanagh Timothy, peddler, bds. 33 Frank
 Kavanagh, see Cavanaugh
 Kavanaugh Betsey, widow, boards 44 Platt
 Kavanaugh James, hackman, h. Mansion c.
 Flint [Flint
 Kavanaugh Mary, widow, b. Mansion cor.
 Kavanaugh Patrick C. policeman, City Hall,
 house 242 Plymouth avenue
 Kavanaugh Thomas, mason, house 53 Smith
 Kavitch Joseph, carriage trimmer, house 28
 Nassau [4 Rowe
 Kay John R. planer, Lake av. near Rowe, b.
 Kay Joseph H. planing mill, Lake av. near
 Rowe, h. 4 Rowe [boards 4 Rowe
 Kay Samuel P. planer, Lake av. near Rowe,

Keady Frank P. tailor, 43 E. Main, boards
 5 Julia
 Keady William, machinist, boards 5 Julia
 Kean Christopher, shoemaker, house 51 W.
 Maple
 Kearns Jane, widow, boards 60 Saxton
 Kearns Julia, widow, b. Frances c. Magnolia
 Kearns Patrick, gilder, h. Frances corner
 Magnolia [45 Smith
 Kearnes John, laborer, Brown c. Jones, h.
 Kearney Alice, music teacher, boards 7 Gar-
 diner park [2 Julia
 Kearney Bernard, driver, hose No. 4, house
 Kearney Edward, stonecutter, 54 Fitzhugh,
 house 148 Hunter
 Kearney John, laborer, house 72 Smith
 Kearney John T. blacksmith, 3 Canal, bds.
 3 Julia [3 Julia
 Kearney Lawrence, bookbinder, 55 State, b.
 Kearney Michael, painter, boards 72 Smith
 Kearney Patrick, house 7 Gardiner park
 Kearney Sarah, widow, house 3 Julia
 Kearns Anna, boarding house, h. 43 Atwater
 Kearns Celia, sewer, 81 N. Water, boards 43
 Atwater [1875
 Kearns Dennis, switchman, deceased, Aug.
 Kearns John, switchman, N. Y. C. R. R.
 bridge, house 117 Childs
 Kearns John, laborer, house 88 Whitney
 Kearns Margaret, widow, house 60 Bolivar
 Kearns Mary A. stitcher, boards 60 Bolivar
 Kearns Thomas, boards 60 Bolivar
 Kearns William M. upholsterer, 74 State, b.
 60 Bolivar
 Kearns see Carnes [Prospect
 Keating Edward F. bookkeeper, boards 59
 Keating John, fireman, Erie Railway, bds.
 at Corning [avenue
 Keating Mary Mrs. h. Magnolia n. Plymouth
 Keating Matthew L. carpenter, boards 59
 Prospect
 Keating Philip, house 59 Prospect
 Keays Richard, tailor, boards 21 Caroline
 Keays Richard jr. shoemaker, h. 21 Caroline
 Keck Martin, farmer, house 31 Walnut
 Keck William, butcher, 114 East Main, bds.
 Scio corner Weld
 Kedie Charlotte F. widow, house 14 Scio
 Keefe Catherine, widow, house 30 Tappan
 Keefe Catharine, widow, house 7 Gorham
 Keefe Gregory, laborer, house Magnolia near
 Frances [2 Pitt
 Keefe James, tinsmith, 72 West avenue, bds.
 Keefe John H. carpenter, boards 30 Tappan
 Keefe John T. shoemaker, 4 Allen, boards 14
 Magne [Pitt
 Keefe Lawrence, hostler, 83 Andrews, h. 2
 Keefe Margaret Mrs. house 61 Hunter
 Keefe Thomas, tobacco dresser, 55 South St.
 Paul, boards 7 Gorham
 Keefer Jefferson T. milkman, house 56 Lime
 Keefer see Kiefer
 Keegan Arthur, carcoupler, house 6 Ontario
 Keegan Arthur, machinist, Brown c. Jones,
 boards 8 Romeyn
 Keegan Bridget, widow, house 8 Romeyn
 Keegan Hubert, bookkeeper, 64 State, bds.
 Brackett House

Keegan Hugh, laborer, house 16 Romeyn
 Keegan Hugh jr. stonemason, 22 West av. h. 19 1/2 Romeyn
 Keegan Jennie, stitcher, boards 8 Romeyn
 Keegan Michael, switchman, Jay st. crossing, b. 16 Romeyn
 Keehan Bridget, boards 18 Munger
 Keehl Caspar, shoemaker, Lake av. n. Ridge road, house at Greece [n. city line
 Keehl John, tanner, 23 N. Water, h. Miller
 Keehl Kittie, clerk, 43 State, b. 37 Nassau
 Keehn Edward J. boots and shoes, 75 West avenue, boards 14 Reynolds
 Keehn Gottlieb, laborer, h. German n. Hebard
 Keehn John, shoemaker, house 111 Campbell
 Keehn John, laborer, house Miller near Bay
 Keehn Richard, butcher, h. 24 University av.
 Keehn William, packer, 75 West av. house 141 Jay
 Keehn William jr. shoemaker, bds. 141 Jay
 Keehne Joseph, mason, house 74 Cypress
 Keel Philip, removed to Williamson
 Keele John, peddler, house 9 Walnut
 Keeler George, deceased, April, 1876
 Keeler James (*Keeler & Winfield*), house 1 Adams
 Keeler John, coachman, bds. 143 East Main
 Keeler Mark K. agent, New Jersey Mutual Life Ins. Co., 18 West Main, h. 69 Meigs
 Keeler Mary, widow, bds. Miller's alley near Atwater
 Keeler Minerva, widow, boards 51 Park av.
 Keeler Sarah Miss, boards 62 South St. Paul
 Keeler Theodore J. V. removed from city
 Keeler J. Joseph, carriage manuf. 9 Ely, h. 119 West avenue
KEELER & WINFIELD (*J. Keeler and W. J. Winfield*), printers, Mill cor. Exchange place.—*See page 544*
 Keely Edward, laborer, 215 State, h. 76 Oak
 Keenan Bridget, widow, b. rear 109 Genesee
 Keenan James, coremaker, rear 204 State, bds. 21 Jones
 Keenan John, hackman, 89 Mill, house do.
 Keenan John, millwright, house 135 Brown
 Keenan John G. laborer, house 71 Smith
 Keenan John M. grocer, 37 Smith, b. 21 Jones
 Keenan Mary, widow, house 44 N. Water
 Keenan Mary E. domestic, 66 Frank
 Keenan Mary J. Mrs. house 252 State
 Keenan Michael, painter, boards 1 Ely
 Keenan Michael M. blacksmith, Brown's race near Furnace, house 21 Jones
 Keenan Patrick, watchman, house 7 Webster
 Keenan Thomas, moulder, house 30 Smith
 Keene Wm. servant, Osburn House [do.
 Keener John, carpenter, 27 Plymouth av. h.
 Keeney Jane A. widow, h. 6 Henion place
 Keeney Mary, widow, boards 77 Allen
 Keesler Lina, stitcher, bds. 44 North Union
 Keays Geo. F. whitewasher, bds. 24 W. Troup
 Keays William, whitewasher, h. 24 W. Troup
 Kefer Gottlieb, boards 104 North St. Paul
 Kegel Nicholas, shoemaker, 127 Scio, h. do.
 Kehl Barbara, widow, house 7 1/2 Kirk
 Kell John, cabinet maker, 7 North Water, boards 7 1/2 Kirk [bds. 7 1/2 Kirk
 Kehl Joseph, cabinet maker, 7 North Water,

Kehn Albin, cabinet maker, 2 Hill, house Wilder corner Childs [alley
 Kehoe John, clerk, 330 State, bds. 31 Brown's
 Kehoe John, shoemaker, 77 N. Water, house 25 Brown's alley
 Kehoe Margaret Mrs. boards 50 Frank
 Kehoe Mary, weaver, boards 50 Frank
 Kehoe Michael, laborer, house 50 Frank
 Kehoe Michael jr. forger, foot Falls, boards 50 Frank [44 Oak
 Kehoe Nicholas, engineer, N. Y. C. R. R. h.
 Kehoe William, temperer, foot Falls, boards 50 Frank [72 Franklin
 Kehrig Frank, clerk, 13 South St. Paul, bds.
 Kei John, laborer, house 151 North Clinton
 Keiber George, teamster, 149 Exchange, h. 65 Lincoln
 Keidel John, carpenter, house 9 Munger
 Keidel John jr. carpenter, boards 9 Munger
 Keil Isaiah, cigarmaker, house Clifford near Conkey avenue
 Keil Nydia, widow, boards 9 Pitt
 Keiling John, tailor, house Miller near Bay
 Keiling Wm. hairdresser, 123 N. Clinton, h. do.
 Keily Martin C. laborer, house 40 Strong
 Keirnan James, student, boards 141 Jones
 Keiser Charles, clerk, boards 32 Ward
 Keiser John, brewer, Roch. Brewing Co. b. Cliff near Lake av. [h. 138 E. Main
 Keiser John A. stock keeper, Mill c. Market,
 Keiser John G. salesman, 76 Mill, h. Palmer's block
 Keiser Joseph, machinist, house 250 North
 Keiser, see Kaiser [30 Griffith
 Keith William, policeman, City Hall, house Keleher Jeremiah, moulder, house 16 S. Ford
 Keleher Margaret, widow, house 16 S. Ford
 Keller Andrew, laborer, house 29 Galusha
 Keller Anna Mary, widow, boards 76 Cypress
 Keller Catharine, tailoress, bds. 31 Galusha
 Keller Charles, baker, 171 Scio, boards do.
 Keller Clemens, laborer, house r. St. Joseph, opposite Hayward park [Sherman
 Keller Francis, laborer, house Curtis corner
 Keller Frederick, tailor, h. 7 Stepheny's park
 Keller George, veterinary surgeon, house 247 North Clinton [Mortimer
 Keller Jacob (*Keller & Goodhue*), house 17
 Keller John, coachman, house 181 Alexander
 Keller John, saloon, 156 Scio, house do.
 Keller John A. nurseryman, house Norton near Hollenbeck
KELLER JOHN B. florist, Mt. Hope av. near Mt. Hope cemetery, house South av. near Oakland.—*See page 527*
 Keller John G. teamster, 134 Mt. Hope av. house 76 Cypress [44 Cameron
 Keller Joseph, laborer, State cor. Platt, house
 Keller Joseph, tailor, b. Huron near Hudson
 Keller Julius, stonemason, boards 29 Galusha
 Keller Lawrence, sashmaker, 7 West Main, boards Norton near Hollenbeck
 Keller Lizzie domestic, 11 Backus avenue
 Keller Lorenz, cabinetmaker, 184 State, house 10 Holland
 Keller Martin, cutter, h. Huron n. St. Joseph
 Keller Michael, butcher, 106 North av. bds. 98 do.

- Keller Michael, butcher, house 1 Delevan
 Keller Nicholas Mrs. propr. Canada House,
 10 North Water, house do.
 Keller Wm. slater, 90 E. Main, b. 29 Galusha
 Keller & Goodhue (*J. Keller and A. J. Good-*
hue), shoe manufacturers, 87 N. Water
 Kellerby William, waiter, Osburn House
 Kellerson John, stonecutter, house Maple cor.
 Saxton
 Kelletts Elizabeth, widow, house 75 Lyell
 Kelletts Samuel, removed to Cleveland, O.
 Kelletts Sarah E. stitcher, boards 75 Lyell
 Kelletts Wm. H. removed to Cleveland, O.
 Kelley Anna Mrs. boarding house, 6 Ely
 Kelley Arthur W. gas fitter, 17 Mill, house
 76 Sibley's block
 Kelley Betsey, widow, boards 14 Spencer
 Kelley Daniel, laborer, Paper Mill, house 9
 Perkins [14 King
 Kelley Edmund J. trimmer, 3 Canal, boards
 Kelley Elizabeth Miss, boards 24 Hawkins
 Kelley James, porter, 57 State, h. 28 Galusha
 Kelley James, teamster, boards 5 Hunter
 Kelley James, blacksmith, 3 Canal, house 15
 St. Clair [Emmett
 Kelley John, cutter, 141 N. Water, boards 14
 Kelley John J. wood turner, Brown c. Jones,
 house 11 Oregon
 Kelley Margaret, seamstress, boards 3 South
 Kelley Margaret, widow, boards 22 Emmett
 Kelley Martin, laborer, house 6 Waverley pl.
 Kelley Mary Ann, domestic, 168 Frank
 Kelley Mary A. Miss, boards 40 Chatham
 Kelley Samuel, swing bridge keeper, Ex-
 change, house 6 Ely
 Kelley Thomas E. machinist, 136 Mill, bds.
 6 Waverley place
 Kelley William H. removed from city
 Kelley William J. cutter, 141 N. Water, bds.
 14 Emmett [boards do.
 Kelley Wm. T. watchman, European Hotel,
 Kelley, see Kelly and Keller
 Kellogg Burt F. hostler, 6 Otsego, house do.
 Kellogg Chester A. house 118 Fitzhugh
 Kellogg Daniel J. portrait artist, h. 15 Selden
 Kellogg Ellen, widow, house r. 13 Jackson
 Kellogg F. B. Mrs. widow, b. Rowe n. Thorn
 Kellogg John, laborer, house r. 13 Jackson
 Kellogg John G. clerk, Osburn House, b. do.
 Kellogg Joseph A. teacher, h. Rowe n. Thorn
 Kellogg Joseph M. sewing machines, 94 East
 Main, boards 121½ do.
 Kellogg Robert D. & Co. (*W. H. Spencer*),
 tobacco manufs. 192 State, h. at Gates
 Kellogg Sam'l B. supt. American Ex. stables,
 6 Otsego, house do. [son
 Kellogg William, laborer, boards r. 13 Jack-
 Kellogg William W. rubber stamp maker, 62
 East Main, boards 4 Park avenue
 Kelly Aggie, chambermaid, Osburn House
 Kelly Alice, milliner, bds. 35 Brown's alley
 Kelly Amanda, fancy goods, 55 Spring, h. do.
 Kelly Annie J. domestic, boards 7 Prince
 Kelly Anton, rag dealer, house 69 W. Smith
 Kelly Bridget, widow, house Saxton n. Lyell
 Kelly Bryan B. moulder, house 12 Catharine
 Kelly Catharine Miss, boards 5 Mortimer
 Kelly Catharine, widow, house 72 Clifton
 Kelly Charles, laborer, boards 41 Magne
 Kelly Dennis, teamster, h. Lyell n. Murray
 Kelly Edward, deceased December, 1875
 Kelly Edward, laborer, house 2 Green
 Kelly Ellen, widow, house 35 Brown's alley
 Kelly Ellen, widow, house Hebard n. Huron
 Kelly George, tinsmith, 65 Exchange, house
 9 Holland [Clifford
 Kelly Hannah C. Mrs. b. Evergreen park n.
 Kelly Henry, removed to Waterloo
 Kelly Howard L. bookkeeper, b. 58 Fitzhugh
 Kelly Hugh, maltster, Atwater cor. North St.
 Paul, house Clifford near Conkey avenue
 Kelly H. Ward, b. Saratoga av. c. Jones av.
 Kelly James, mason, boards 72 Clifton
 Kelly James, laborer, h. Frances c. Magnolia
 Kelly James, cooper, Brown's alley h. 35 do.
 Kelly James, cooper, Charles c. Butler, h.
 233 Plymouth av. [draws, h. 170 Scio
 Kelly James, shoemaker, N. Water cor. An-
 Kelly James, engineer, House of Refuge,
 boards do.
 Kelly James H., Kelly lamp works, Mill cor.
 Furnace, h. Saratoga av. cor. Jones av.
 Kelly James H. bookkeeper, h. 57 S. Union
 Kelly Johanna, widow, boards 11 Kent alley
 Kelly John, tailor, house 244 Exchange
 Kelly John, joiner, house 17 Romeyn
 Kelly John, laborer, Platt c. Kent, house 89
 Adams [145 Jones
 Kelly John, carpenter, 40 Fulton av. house
 Kelly John, clerk, boards 71 Adams
 Kelly John, laborer, h. 135 Saxton near R. R.
 Kelly John, shoemaker, 15 Mill, h. 71 Uni-
 versity avenue [draws, house 1 Ward
 Kelly John, shoe manuf. N. Water cor. An-
 Kelly John, machinist, house 104 Whitney
 Kelly John, moulder, boards 16 Clifford
 Kelly John, hackman, 85 Front, house do.
 Kelly John, bartender, 138 W. Main, house
 71 Adams
 Kelly John, laborer, house 100 Exchange
 Kelly John C. bootmaker, h. 71 University
 avenue [works, b. 233 Plymouth av.
 Kelly John Edward, cooper, Vacuum oil
 Kelly John E. clerk, h. Saratoga avenue near
 Costar
 Kelly John M. boilermaker, bds. 65 Bolivar
 Kelly John O. miller, bds. 154 North St. Paul
 Kelly John R. removed to Avon
 Kelly Joseph, laborer, b. Lincoln n. Landing
 Kelly Joseph, saloon, 9 Hill, house do.
 Kelly J. Miller, secretary Kelly Lamp Works,
 Mill cor. Furnace, boards 154 Lyell
 Kelly Katie, tailoress, boards 38 Allen
 Kelly Katie, seamstress, boards 35 Chestnut
KELLY LAMP WORKS, locomotive head
 lamps and lanterns, Mill cor. Furnace.—
See page 689
 Kelly Lorenzo, sec. Roch. Union and Adver-
 tiser Co. 82 W. Main, house 58 Fitzhugh
 Kelly Maggie, domestic, Osburn House
 Kelly Martin, laborer, b. Hebard n. Huron
 Kelly Mary, chambermaid, Osburn House
 Kelly Mary, widow, house 80 Atkinson
 Kelly Mary, domestic, 84 Lake avenue
 Kelly Mary Miss, house Kent alley n. R. R.
 Kelly Mary, waiter, Whitcomb House

- Kelly Mary Miss, dressmaker, 5 Mortimer, house do.
 Kelly Mary A. widow, house 64 Campbell
 Kelly Mary J. Miss, stitcher, boards 14 King
 Kelly Michael, switchman, Pitt st. R. R. crossing, house 115 North Clinton
 Kelly Michael jr. gardener, 34 Sophia, bds. rear 11 Montrose
 Kelly Michael, laborer, house 41 Magne
 Kelly Michael, Genesee Valley House, Exchange corner Spring
 Kelly Patrick, laborer, h. Frances n. Magnolia
 Kelly Patrick, switchman, house 14 Emmett
 Kelly Patrick jr. laborer, boards Frances n. Magnolia [38 Allen
 Kelly Patrick, laborer, Platt c. Kent, boards
 Kelly Patrick H. tobacco cutter, 55 S. St. Paul, boards rear 21 Monroe avenue
KELLY PETER, boilermaker, 130 Mill, n. Platt, house 65 Bolivar.—See page 672
 Kelly Robert, carpenter, house Monroe av. c. Goodman
 Kelly Rosa A. Mrs. dressmaker, b. 14 King
 Kelly Rosanna, dressmaker, 14 King, h. do.
 Kelly Thomas, house 302 State
 Kelly Thomas, presser, boards 308 State
 Kelly Thomas, collar maker, 98 E. Main, b. 16 Joiner
 Kelly Thomas, laborer, h. rear 21 Monroe av.
 Kelly Thomas E. boilermaker, b. 65 Bolivar
 Kelly Thomas F. tailor, 124 W. Main, h. do.
 Kelly T. Peter, grocer, 162 Exchange, h. do.
 Kelly William, house Lincoln near Landing
 Kelly William, boards 80 Atkinson
 Kelly William, shoemaker, 14 State, bds. York House
 Kelly William, shoemaker, bds. 14 Emmett
 Kelly William, shoemaker, 340 State, house 348 do. [Water, b. Wimble House
 Kelly William, coachman, Atwater cor. N.
 Kelly Wm. H. collar maker, 98 E. Main, b. r. 21 Monroe avenue [West Main
 Kelly William H. cabinetmaker, bds. 218 Kelly, see Kelley and Keller
 Kelsey Elizabeth H. widow, house 12 Greig
 Kelsey Henry H. weighmaster, h. 355 Brown
 Kelsey Sardiuss P. at Osburn House, house 18 Stone
 Kemnitz Frederick, laborer, house 35 Mark
 Kemp William, fireman, N. Y. C. R. R. bds. 13 Jones
 Kemp William R. boatman, h. 33 Huntington
 Kempe Julius J. physician, 11 Grove, h. do.
 Kempf Frank, removed to Philadelphia, Pa.
 Kempf Frederick, cooper, Butler c. Charles, house 85 Frances
 Kempf John, peddler, boards 85 Frances
 Kempf Joseph, blacksmith, h. 232 N. Clinton
 Kempf Michael, riveter, 3 Elizabeth, boards 85 Frances
 Kempf Philip, tailor, house 57 Lowell
 Kempfert Charles, laborer, h. r. 316 N. Clinton
 Kempf John, shoemaker, 114 West Main, h. 90 Saxton
 Kempf Rose, weaver, boards 90 Saxton
 Kempshall Charlotte, dec. Dec. 16, 1875
 Kempton Kate A. dressmaker, 87 East Main, house do.
 Kendall Lewis S. (Cone & Kendall), 11 East Main, bds. 16 North av.
 Kendall Mary A. widow, house 10 Orange
 Kendall M. J. baker, 132 State, boards 170½ West Main [b. 54 Tappan
 Kendall Stephen H. tobacconist, 87 North av.
 Kendall W. M. agent, 100 State, b. Brackett House
 Kendlin Patrick, buss driver, Whitcomb House [South avenue
 Kendrick Anna A. music teacher, bds. 89
 Kendrick Asahel C. professor, University of Rochester, house 48 Chestnut
 Kendrick George C. cutter, 64 Mill, house 89 South avenue
 Kendrick John R. teamster, 168 South St. Paul, boards 89 South avenue
 Kenealy Agnes, clerk, Mill c. Platt, boards 52 Frank [h. 38 Allen
 Kenealy Edward, moulder, rear 204 State,
 Kenealy Patrick, laborer, house 52 Frank
 Kenealy Sebina Mrs. boarding house, 38 Allen, house do.
 Kenison Rosetta, widow, house 9 Sycamore
 Kenison Sidney R. teamster, bds. 9 Sycamore
 Kennagh Magaret, widow, h. Myrtle n. Lyell
 Kennagh Thomas, laborer, b. Myrtle n. Lyell
 Kennagh William, fireman, b. Myrtle n. Lyell
 Kennedey Ellen, widow, house 4 Julia
 Kennedy Ann, widow, house 25 Brown
 Kennedy Annie, domestic, bds. East av. n. Goodman
 Kennedy Bridget, widow, b. 58 Brown block
 Kennedy Donald, removed to Clarendon
 Kennedy Elizabeth H. Mrs. house 59 Meigs
 Kennedy Emily M. widow, h. 6 Hubbell pk.
 Kennedy George H. machinist, b. 108 Frank
 Kennedy George W. cutter, 4 Mumford, bds. 18 Greig
KENNEDY HARRIE R. stoves, tinware, &c. 100 South avenue, bds. 59 Meigs.—See page 627 [Meigs
 Kennedy, Herman M. painter, 14 Stone, bds.
KENNEDY JAMES, merchant tailor, 8 Mumford, house 18 Greig.—See page 537
 Kennedy James, shoemaker, 75 N. Water, h. 56 South Union
 Kennedy James R. cutter, 4 Mumford, bds. 18 Greig
 Kennedy John, teamster, h. 139 Caledonia av.
 Kennedy John W. removed from city
 Kennedy Joseph H. painter, boards 59 Meigs
 Kennedy Mark H. boards Saxton cor. R. R.
 Kennedy Martin, teamster, Model Mills, h. 46½ Lyell
 Kennedy Martin H. painter, house 59 Meigs
 Kennedy Mary, dressmaker, boards 4 Julia
 Kennedy Nancy T. widow, h. 26 Frost av.
 Kennedy Rosa Mrs. boards 28 Litchfield
 Kennedy Thomas, woodworker, house 11 Whitney [cent place
 Kennedy Thomas, teamster, boards 16 Vin-Kennedy Thomas, moulder, Brown's race n. Furnace, house 108 Frank
 Kennedy William H. tinsmith, 174 W. Main, house 24 Nassau
 Kennelly Edward M. clerk, cigar stand, Powers' buildings, b. 27 Fitzhugh

HENRY C. WISNER,

MAJOLICA, KIYOTA AND JAPANESE CHINA,
 No. 33 STATE STREET.

Kennelly James, blacksmith, 183 West av.
house 26 West avenue
Kennelly John, grocer, 38 Front, house do.
Kennelly John, removed to Charlotte
Kennelly Michael H. restaurant, 30 Power's
bldgs. house 27 Fitzhugh
Kennelly Nellie, waiter, Whitcomb House,
boards do.
Kenner Carrie, domestic, bds. 118 Alexander
Kenney Bertha B. widow, h. 165 North av.
Kenney Elizabeth, widow, h. 194 E. Main
Kenney John H. fireman, bds. 165 North av.
Kenney John W. shoemaker, 87 N. Water,
boards 75 Joiner
Kenny Mary, widow, house 75 Joiner
Kengnott Frederic, tanner, Bay n. plank
road, house do. [plank road
Kengnott Frederic jr. tanner, bds. Bay near
Kenning Charles, clerk, 50 North avenue,
boards 48 do.
Kenning Charles, baker, 34 Atwater, h. do.
Kenning Charles W. (*F. Seifried & Co.*), bds.
34 Atwater
Kenning Henry J. varnisher, bds. 54 Martin
Kenning Herman, deceased Feb. 1876
Kenning Herman, confectioner, 120 State, b.
48 North avenue [34 Atwater
Kenning John E. clerk, 147 E. Main, boards
Kenning Margaret, widow, house 54 Martin
Kenning Theodore G. clerk, 12 West Main,
boards 48 North avenue [h. 48 do.
Kenning Theodore J. grocer, 50 North av.
Kennison Henry, teamster, 107 S. St. Paul,
house 29 William
Kenny John, switchman, house 16 Lime
Kenny Matthew, shoemaker, house 7 Bloss
Kenny Matthew, fireman, h. Lime c. Orchard
Kenny Patrick, laborer, b. Lime c. Orchard
Kenny Rosanna Mrs. grocery, 7 Bloss, h. do.
Kensey James, sawmaker, 153 State
Kent George S. butcher, house 27 Scio
Kent George W. boards 1 Cedar
Kent Jacob L. mason, house 134 N. St. Paul
Kent John H. photographer, 58 State, house
19 South Washington
Kent Phila, widow, house 162 West Main
Kenyon George W. salesman, 36 State, bds.
146½ West Main
Kenyon Rinaldo S. (*Kenyon & Hunt*), 100
State, house 31 Fitzhugh
KENYON & HUNT (*R. S. Kenyon and D.
T. Hunt*), hats, caps, furs, 100 and 102
State.—*See page 541* [cor. Delevan
Kenzie Samuel, foreman, 3 Canal, house Scio
Keogh Ann, domestic, Saratoga avenue cor.
Jones avenue
Keogh Catharine, widow, b. 15 Gardiner pk.
Keogh Edward F. upholsterer, h. 59 Hickory
Keogh James, auction room, 25 South St.
Paul, house 15 Gardiner park
Keogh Patrick, piano maker, 4 Hill, house
43 Hickory
Keough Timothy, laborer, h. 31 Brown's al.
Kerber Frederick, watchman, Roch. Brew-
ing Co. foot Cliff [n. Norton
Kerber John M. nurseryman, house Goodman
Kerber Sebastian, frame moulder, 38 Gorham,
house Alphonse near Hudson

Kermode Jas. bartender, 4 Railroad avenue,
house 53 Vienna
Kermode Sarah, widow, house 53 Vienna
Kermode William, lunch room, Brackett
House, boards do. [North avenue
Kern August, shoemaker, 15 Mill, house 157
Kern Edward W. clerk, 116 East Main, bds.
3 Tyler [N. Clinton
Kern Emil, carpenter, 23 Gorham, h. av. A n.
Kern Frederica, carpet weaver, 42 Howell,
house do. [138 Lake av.
Kern Frederick (*Nells & Kern*), 166 State, h.
Kern John A. cigarmaker, Leavenworth al.
near Champion, bds. 102 Front [Tyler
Kern Lewis, carpenter, 54 North av. bds. 3
Kern Martha H. widow, house 47 Nassau
Kern Matthias, tailor, h. 3 Tyler [at Greece
Kernan John, foreman, 158 Lake av. house
Kernan Margaret, saloon, 26 N. Water, h. do.
Kernan Mary, waiter, Whitcomb House, b. do.
Kernan Thomas, house Union c. Asylum
Kerner Catharine, widow, h. 1 Summer al.
Kerner John, gilder, 43 N. Water, boards 1
Summer alley
Kerner Peter, sawyer, River near North St.
Paul, boards 1 Summer alley
Kerney Mary, domestic, 29 Lake avenue
Kerngood Edward (*L. Garson & Co.*), 44 Mill,
house at Denver, Col.
Kerngood Fanny, widow, house 16 Pleasant
Kerngood Jacob, tobacconist, 49 East Main,
boards 16 Pleasant [bds. 16 Pleasant
Kerngood Moses, tobacconist, 49 East Main,
Keron Mary A. dressmaker, boards 59 Court
Kerr Sarah A. widow, boards 185 State
Kerran John, laborer, house 45 Smith
Kerran Katie, dressmaker, boards 45 Smith
Kershaw Frances M. deceased April, 1875
Kesby Julia, sewer, boards 153 University av.
Kesby William, mason, h. 153 University av.
Kesel Frederick, baker, N. Clinton c. Oak-
man, house do.
Kesler Minnie, domestic, 40 N. St. Paul
Kesler Peter, repairer, Erie Railroad repair
shop, house W. Maple c. Ames
Kessel Andrew, blacksmith, h. 13 Murray
Kesseling Philip, tailor, bds. 160 St. Joseph
Kesseling Nicholas, tailor, 160 St. Joseph,
house do.
Kessler Anton, tailor, house Clifford c. Henry
Kessler Benedict C. cooper, Butler c. Charles,
house 72 Childs [Brown
Kessler John, machinist, 123 Mill, bds. 362
Kessler John A. clerk, 28 Mumford, bds. do.
Kessler John H. grocer, 28 Mumford, h. do.
Kessler Margaret, widow, house 362 Brown
Kessner Wilhelmina Mrs. h. 80 St. Joseph
Kester Caspar, laborer, 19 Warehouse, boards
116 Campbell
Kester Doroughta, widow, h. 116 Campbell
Kester, see Koester
Ketcham Allen J. removed to Clarkson
Ketcham Charles H. deceased May, 1875
Ketcham Richmond A. agent, 93 State, house
54 Hickory [house do.
Ketter Margaret Mrs. clairvoyant, 21 Nassau,
Ketter Peter, shoemaker, house 21 Nassau
Ketz August, gardener, bds. 150 S. St. Paul

Kewer Richard, groom, boards 12 N. Water
 Kewin James, stage driver, Osburn House
 Kewin Elizabeth, teacher, Jay School No. 21, boards 96 Allen
 Kewin Margaret, widow, house 15 William
 Kewin W. J. stoves, 97 East av. b. 15 William
 Keyel Jacob, nurseryman, house Monroe av. corner Meigs
 Keyel John, laborer, b. Monroe av. c. Meigs
 Keyel Mary Miss, housekeeper, Monroe av. corner Meigs [11 Franklin
 Keyes Clarence E. billiards, 7 S. St. Paul, h.
 Keyes Daniel L. 7 S. St. Paul, b. 11 Franklin
 Keyes Jerome (*Keyes & Munn*), house 48 Plymouth avenue
 Keyes Martha, widow, house 55 Alexander
 Keyes Prudentia M. Miss, bds. 55 Alexander
 Keyes Sarah L. Miss, boards 55 Alexander
 Keyes Silas L. nursery stock, h. 23 Gardiner park [hinge manufacturers, 9 Platt
 Keyes & Munn (*J. Keyes and H. C. Munn*), Kibbe William B. clerk, 15 Exchange, bds. 8 Tremont
 Kidd Iron Works, 106 Mill [126 do.
 Kidd John W. laborer, 153 S. St. Paul, house
 Kidd William 2d, sec. Kidd Iron Works, Brown's race [Lyell
 Kidman George, miller, C. B. Hill's house 31
 Kiefer Amelia, dressmaker, bds. 36 Tremont
 Kiefer Andrew, millwright, h. 36 Tremont
 Kiefer Caroline, boards 18 Joiner
 Kiefer Charles, currier, 18 N. Water, house North Clinton near Norton
 Kiefer Elizabeth, widow, h. 32 Hamilton pl.
 Kiefer John, laborer, h. Hollenbeck n. Norton
 Kiefer Joseph, laborer, boards Hollenbeck
 Kiefer Louis, shoemaker, house 39 Marshall
 Kiefer Louis, blacksmith, 101 North avenue, house do.
 Kiefhaber John H. dry goods, 221 E. Main, house do. [110 West av.
 Kiely Edward J. broommaker, 5 N. Ford, b.
 Kiely Michael, carpenter, h. 110 West av.
 Kiesow William, hostler, b. 120 Mt. Hope av.
 Kiesz Mary, widow, house 9½ Thomas
 Kiesz Philip, laborer, boards 9½ Thomas
 Kieter Charles, teamster, 139 North St. Paul, house 28 Hoeltzer
 Kihler John, machinist, h. 11½ Monroe av.
 Kilcullon Marcus, driver, steamer No. 1, 36 Stone, boards do.
 Kiley John, clerk, house 6 Hunter
 Kiley Patrick, laborer, h. Clifton n. Summer
 Kiley Thomas, painter, bds. 96 S. St. Paul
 Kilgore William F. clerk, 64 State, boards 170½ West Main [Bernard
 Kilian Conrad, hackman, house Hudson near
 Killacky Hugh, moulder, boards 54 Allen
 Killacky James, machinist, boards 37 Frank
 Killacky Michael, marble polisher, boards 54 Allen
 Killacky Thomas, marble polisher, 122 S. St. Paul, h. 77 Magne
 Killerby David, carpenter, house 8 Stone
 Killick Edmund, farmer, house Wolcott near city line [h. 79 Atwater
 Killip Catharine C. dressmaker, 9 N. Clinton,
 Killip Eliza, dressmaker, boards 79 Atwater

Killip Frederick M. machinist, 123 Mill, b. 2 Oregon [Nassau
 Killip James, market, 224 State, house 57½
 Killip James jr. heelcutter, 124 Front, bds. 57½ Nassau
 Killip John, shoemaker, house 79 Atwater
 Killip John T. carpenter, 127 Mill, boards 79 Atwater
 Killip Louisa J. Mrs. house 7 Prince
 Killip William, millwright, 127 Mill, house 2 Oregon
 Killip William, mason, boards 171½ E. Main
 Killip William H. machinist, bds. 2 Oregon
 Kilpatrick John, stonecutter, Oak c. Smith, boards 134 Oak [b. 80 Atkinson
 Kilpeck John E. shoemaker, 83 N. Water,
 Kilpeck Martin, grocer, 108 Cady, house do.
 Kilroy Ann, widow, house 37 George
 Kilroy James, carpenter, boards 37 George
 Kilroy Michael, clerk, E. Main c. North av. boards 37 George [64 do.
 Kimball Charles H. clerk, 55 S. St. Paul, b.
 Kimball Collins B. house 76 University av.
 Kimball Edward J. clerk, 55 S. St. Paul, boards 64 do.
 Kimball Eugene B. clerk, 2 Corinthian Hall' bldg. boards 76 University av.
 Kimball Frank E. removed to Troy
 Kimball Fred. C. boards 76 University av.
 Kimball H. J. Mrs. house 76 University av.
 Kimball Jared W. boards 76 University av.
 Kimball Peter N. car driver, house 255 State
 Kimball Solomon F. house 220 East Main
KIMBALL WILLIAM S. & CO. (*J. C. Hart*), tobacconists, 53 South St. Paul, house 64 do.—*See page 565*
 Kimball, see Kimble
 Kimbark Laura A. widow, b. 55 Lancaster
 Kimbark Sarah T. widow, house 24 Meigs
 Kimbel John, car inspector, bds. 56 Lorimer
 Kimberly R. R. removed to Auburn
 Kimble Charles A. painter, 14 Stone, house 51 Delevan
 Kimble Chauncey C. painter, h. 34 Edmonds
 Kimble Henry B. carpenter, house 81 Weld
 Kimmel August (*J. & A. Kimmel*), grocer, 43 North avenue, house do.
 Kimmel Elizabeth, domestic, 8 Lyell
 Kimmel Johanna, widow, house 18 Sellinger
 Kimmel John, shoemaker, 15 Mill, house 72 Orange [43 North av.
 Kimmel John & A. coal dealers, 165 Scio, b.
 Kimmel Joseph, stonecutter, 54 Fitzhugh, boards 18 Sellinger
 Kimmerer Minges, laborer, h. Miller n. Bay
 Kimmerling John, laborer, house 8 Huron
 Kimpal Charles F. lunch rooms, 5 Mill, house 42 William [av.
 Kimpel George A. laborer, h. 189 Pinnacle
 Kimpel George J. saloon, 82 S. St. Paul, h. 221 Pinnacle avenue
 Kimpel John N. removed to New York city
 Kimpel Joseph C. polisher, b. 221 Pinnacle av.
 Kimpel Margaret, matron, Student's Home 118 Alexander, house do.
 Kimpel Philip, butcher, 43 Front, boards 118 Alexander [18 Lawrence
 Kinde August H. pianomaker, 4 Mill, house

- Kinde Lewis, tailor, house Bay near Miller
 King Allen L. bookkeeper, b. 42 Manhattan
 King Ann, widow, house 27 Romeyn
 King Antoinette, widow, h. 57 University av.
 King Catharine, widow, house 317 Brown
 King Charles, hackman, boards 204 Brown
 King Charles D. student, Rochester Theological Seminary, bds. Trevor Hall
 King Charles E. clerk, 117 E. Main, bds. 52 University avenue [house do.]
 King Charles H. blacksmith, Lyell near R. R.
 King Douglass S. clerk, house 10 Pearl
 King Edward, blacksmith, h. 44 Savannah
 King Edward J. carver, Jay cor. Erie canal, house 113 Hunter
 King Edwin H. student, University of Roch. boards 8 James
 King Elizabeth, widow, house 61 Adams
 King Elizabeth F. boards 73 East avenue
 King Emeline Mrs. house 35 Hudson
 King Fernando L. bookkeeper, 96 E. Main, house 8 Pearl [av.]
 King George, clerk, 1 State, b. 16 McDonald
 King George A. driver, house 291 State
 King George D. saloon, University av. near railroad, house do.
 King George H. boards 17 Adams
 King George T. clerk, 36 State, h. 47 Tremont
 King George W. printer, 1 Aqueduct, boards 47 Glasgow
 King George W. removed from city
 King Harriet, widow, bds. 33 Caledonia av.
 King Herbert S. salesman, 20 State, bds. 33 Sophia
KING HIRAM T. Flour City Ice, 21 Ward, house do.—*See page 559*
 King Horace, deceased January 1, 1876
 King Isaac, trimmer, 87 Exchange, boards 3 Holland
 King James B. clerk, 14 Exchange, house at Niagara Falls [Glasgow]
 King James C. foreman, 87 Exchange, h. 39
 King Jeremiah, waiter, Congress Hall, house 195 Oak [bridge, b. 26 South
 King John, carpenter, west end Court street
 King John C. wood moulder, 3 Aqueduct, h. 20 Asylum
 King John C. salesman, 42 East Main, house 118 West Atkinson [Platt
 King John F. blacksmith, h. steamer No. 3,
 King John R. removed to Elmira
 King Sarah, widow, house 33 Sophia
 King J. George, peddler, house 9 Cliff
 King Lucian B. house 17 Adams
 King Lyman, house 8 Pearl
 King Marcus, brakeman, N. Y. C. R. R. h. North Union cor. Augusta
 King Margaret, widow, house 8 Maple
 King Martin, farmer, h. Goodman n. Norton
 King Moses, house 21 Madison
 King Moses B. (*Gordon, Van Zandt & Co.*), 50 Exchange, house 143 Fitzhugh
 King Orrilla, widow, boards 272 State
 King Patrick, blacksmith, Brown c. Jones, house Murray near N. Y. C. R. R.
 King Richard, mason, boards 27 Romeyn
 King Seymour, bookkeeper, 13 Warehouse, house 16 Pennsylvania avenue
 King Seymour T. door maker, 13 Warehouse, h. Campbell near Whitney
 King Thomas, laborer, house 27 Lime
 King Thomas, hackman, boards 27 Romeyn
 King Willard M. painter, 14 Stone, bds. 107 1/2 East Main [Sanford
 King Wm. H. (*Wm. King & Son*), boards 8
 King Wm. H. agent, 14 N. Water, b. 39 N. St. Paul
 King Wm. R. fish peddler, h. r. 31 Alexander
KING WILLIAM & SON (*W. H. King*), nurserymen and florists, 123 Mt. Hope avenue, house 8 Sanford.—*See page 526*
 Kingdon Oliver F. conductor, N. Y. C. R. R. house 52 Tappan
 Kingsbury Augusta Miss, teacher, boards 28 South Ford [house 48 Jay
 Kingsbury Gilbert J. (*Kingsbury & Davis*), Kingsbury Henry D. baths, 185 Powers' buildings, h. Scott alley n. W. Main
KINGSBURY & DAVIS (*G. J. Kingsbury G. T. Davis*), cracker and biscuit machine manufacturers, Shawmut Mill.—*See page 680*
KINGSLEY HOMER A. & CO. (*H. Jackson and H. H. Howard*), hardware, 112 E. Main, house 68 Chestnut.—*See page 631*
 Kingsley Charles J. carpenter, b. 46 Tappan
 Kingsley Deborah M. Mrs. house 46 Tappan
 Kingsley Frances M. widow, h. 80 West av.
 Kingsley Frank (*Kingsley & Brothers*), 92 Powers' buildings, bds. Farmers' Hotel
 Kingsley Kate, boarding house, 36 N. Washington, house do.
 Kingsley & Brothers (*F. Kingsley and P. R. Brothers*), real estate, 92 Powers' bldgs.
 Kingston Elizabeth Miss, dressmaker, b. 12 Seward
 Kingston Ellen, widow, house 132 Jones
 Kingston George, mason, boards 16 Seward
 Kingston George W. clerk, N. Y. C. R. R. Brown, boards 132 Jones
 Kingston John, mason, boards 77 Tremont
 Kingston John E. shoe cutter, 55 Mill, b. 125 Adams [Adams
 Kingston Richard, shoe cutter, 55 Mill, h. 125
 Kingston Richard jr. tinsmith, 90 E. Main, h. 123 Adams
 Kingston Wesley J. ass't store keeper, N. Y. C. R. R. Brown c. Kent, b. 132 Jones
 Kinkel Frederick, cutter, 25 Mill, boards Scio corner Huron [boards do.]
 Kinlan Patrick, buss driver, Whitcomb House,
 Kinleyside Eleanore T. teacher, Riley School, No. 14, boards 196 Alexander
 Kinleyside Elizabeth, deceased, April, 1875
 Kinleyside Isabella, teacher, b. 196 Alexander
 Kinne Clarence J. boards 21 Atwater
 Kinne Cyrus C. engineer, house 21 Atwater
 Kinne George C. engineer, N. Y. C. R. R. h. 21 Atwater [Romeyn
 Kinnear John, miller, 5 Aqueduct, house 26
 Kinneman Frederick, shoemaker, h. 7 First
 Kinnen Paul, mason, house 106 Hudson
 Kinning Ann Mrs. h. rear 166 Plymouth av.
 Kinning Frederick R. machinist, bds. rear 166 Plymouth avenue
 Kinsella Michael, boards 22 Glasgow

- Kinsey Edwin F. engraver, 20 W. Main, h. 23 Broadway
 Kinsey Frank W. printer, 46 Oak, b. 27 do.
 Kinsey James T. sawmaker, boards 27 Oak
 Kinsey Josiah J. engraver, 20 W. Main, bds. 25 Emmett [Tremont
 Kinsey Luke, pattern maker, 8 Hill, house 113
 Kinsey Mark, agent, house 25 Emmett
 Kinsey Thomas, carpenter, house 27 Oak
 Kinsey Frank, collar maker, 129 State, bds. 17 Frank
 Kinsky John, printer, 3 W. Main, boards Henrietta avenue near Pinnacle avenue
 Kinsky Joseph, carpenter, h. Henrietta av. near Pinnacle av. [Pinnacle av.
 Kinsky Peter, carpenter, h. Henrietta av. n.
 Kinzel Wm. shoemaker, 25 Hickory, h. do.
 Kinzell George, tailor, 50 Pinnacle av. h. do.
 Kinzell John, mason, house 1½ Shamrock
 Kinzell John, tailor, 50 Pinnacle av. h. do.
 Kipferl John, mason, h. Clifford n. Hudson
 Kipp Phillip, blacksmith, Brown c. Jones, h. 8 Wilder
 Kipphut Charles, laborer, house 20 Rhine
 Kipphut Charles B. laborer, house 10 Bay
 Kipphut Frederick, stone cutter, 54 Fitzhugh, h. 51 Henry
 Kipphut Joseph, mineral water maker, 114 N. Clinton, h. 42 Vienna
 Kipphut Louis, tanner, house 53 Strong
 Kipphut Louis, file cutter, River n. N. Water, bds. 156 N. Clinton
 Kirby Elizabeth, widow, house 149 E. Main
 Kirby Hanora Miss, tailoress, b. 52 Nassau
 Kirby Harry, laborer, Jay corner Erie canal, house 35 Smith
 Kirby John, boilermaker, Exchange opp. Glasgow, h. 62 Hunter
 Kirby John, stripper, Magnolia n. Genesee
 Kirby Micajah W. boards Osburn House
 Kirby Robert, stone cutter, 22 West av. bds. 60 Prospect
 Kirby Thomas, wagon maker, 115 South St. Paul, house 3 Howell
 Kirby Walter, boilermaker, Exchange opp. Glasgow, boards 62 Hunter
 Kircher Albert F. hairdresser, bds. 31 Davis
 Kircher Joseph, carpenter, h. 24 Childs
 Kirchhoff George, boards 69 Front
 Kirchhoff Nicholas, baker, 69 Front, h. do. 43 St. Joseph [11 Marshall
 Kirk Charles L. shoe cutter, 73 N. Water, b.
 Kirk John M. cutter, 24 State, h. 7 Marshall
 Kirk Mary A. widow, boards 6 Henion place
 Kirk Thomas, carriage maker, 3 Canal, bds. 5 Bolivar [man near Monroe av.
 Kirkland Joseph, shoemaker, house Good-
 Kirkland Marionette H. Miss, boards 9 Jones
 Kirkpatrick David J. machinist, Mill corner Factory, boards 50 Allen [line
 Kirkpatrick James, laborer, h. Stanley n. city
 Kirkpatrick Matthew, carpenter, house 7 Romeyn [house do.
 Kirkpatrick Robert, stove repairer, 1 Spring,
 Kirkpatrick Sarah Mrs. boarding-house, 50 Allen [House
 Kirkpatrick William, carriage driver, Osburn
 Kirkwood James E. actor, Rochester Opera House, b. Chapman House [Glasgow
 Kirley Andrew J. supt. 64 State, house 12
 Kirley Annie E. dressmaker, 9 Ambrose, h. do.
 Kirley Bridget, dressmaker, b. 9 Ambrose
 Kirley Charles P. salesman, bds. 30 Tremont
 Kirley James removed to Cleveland, O.
 Kirley Philip, house 30 Tremont
 Kirley Wm. J. clerk, 64 State, b. 30 Tremont
 Kirsch Barbara, stitcher, boards 82 Orchard
 Kirsch John, carpenter, house 71 Campbell
 Kirsch John E. boat builder, h. 82 Orchard
 Kirsch Martin, machinist, boards 82 Orchard
 Kirsch Minnie, stitcher, boards 82 Orchard
 Kirsch Valentine, boatbuilder, h. 74 Saxton
 Kirschner William, cooper, Smith n. Erie canal, house 21 Saxton
 Kirst Matthias, brewer, 106 St. Joseph, h. do.
 Kirstein Edward, traveling agent, h. 10 Rome
 Kirsten Charles F, laborer, boards 51 Lime
 Kirsten Henry, laborer, house 51 Lime
 Kirsten Herman, cooper, Magne opp. Walnut, boards 51 Lime
 Kirtland Gilbert C. mason, house 36 Griffith
 Kislingbury Frank W. painter, 3 Canal, h. 119 Atkinson
 Kislingbury John, painter, house 82 Adams
 Kislingbury John jr. painter, h. 82 Adams
 Kislingbury John P. painter, house 84 Reynolds [Jay, house do.
 Kislingbury Margaret Mrs. dressmaker, 5
 Kislingbury Maria Miss, dressmaker, boards 5 Jay [b. 82 Adams
 Kislingbury William H. clerk, 45 E. Main,
 Kisol Andrew, blacksmith, 125 N. St. Paul, house Jay near Childs
 Kissenmaker Fred. laborer, house 28 German
 Kist Emma C. Mrs. dressmaker, 248 State, house do. [house 248 State
 Kist Philip J. carriage painter, 31 Mumford,
 Kister John, porter, Chapman House, b. do.
 Kither Charles F. C. carriage maker, boards 28 Hoeltzer
 Kither Charles L. teamster, h. 28 Hoeltzer
 Kittler John, teamster, house 4 George's pk.
 Kittlinger Conrad, cartman, house 33 Cole
 Kitts Giles F. farmer, house West avenue corner Hague
 Kittwig Arnst, mason, house 13 Oakman
 Kitzel George, gardener, house rear 23 Cole
 Kitzel Michael, grocer, 71 Lowell, house do.
 Klahn Frederick, stone cutter, house 191 Scio
 Klalle Christina, dressmaker, b. 120 Mt. Hope avenue
 Klauck John, laborer, house 13 Rauber
 Klausen John, carpenter, house 45 Scrantom
 Klausen John H. cigarmaker, h. 20 Hawkins
 Klear John, shoemaker, house 19 Syke
 Kleasen John, painter, house 37 Rhine
 Kleasen Martin, finisher, boards 37 Rhine
 Kleber Frank, cabinetmaker, house 32 North Frances
 Kleber John, gilder, 110 Front, b. 8 Wilder
 Klee George, teamster, house 107 Meigs
 Klee Joseph J. carpenter, boards 107 Meigs
 Klee Kate Miss, 205 Plymouth avenue, bds. 40 Seward
 Kleeh Lawrence, laborer, house 40 Seward

HENRY C. WISNER,

CLOCKS--AGENCY FOR ANSONIA CLOCK CO.,
 No. 33 STATE STREET.

- Kleh Anthony, clerk, 6 South St. Paul, house 30 Oakman
- Kleh Charles, turner, house 141 Pinnacle av.
- Klehamer Magdalena, widow, house 1 Johnson park [near Norton]
- Klehammer John, carpenter, bds. North av.
- Klehammer Joseph, laborer, rear Exchange near Court, house 119 Fitzhugh
- Klehammer Louis, laborer, 38 Gorham, h. Stewart near North avenue
- Klehammer Michael, milk dealer, house North avenue near Stewart
- Klehammer Philip, laborer, h. Third avenue near Bay [avenue near Norton]
- Klehammer Sigismund, laborer, house North
- Klehr Jacob, tailor, house 10 Oakman
- Klein Adam, blacksmith, North St. Paul opposite Gorham, house 24 Rauber
- Klein Amelia, widow, house 9 Marshall
- Klein Augustus, mason, house 25 Oakman
- Klein Barbara, widow, h. St. Joseph near Norton [Norton]
- Klein Charles, shoemaker, b. St. Joseph n.
- Klein Charles, hackman, boards 106 Tappan
- Klein Charles, boxmaker, 3 Aqueduct, b. 6 North York cor. R. R.
- Klein Charles A. machinist, Brown's race n. Furnace, h. 29 Scrantom
- Klein Chris. laborer, house 46 German
- Klein Eugene, clerk, 118 State, b. Reed House
- Klein Frederick, stoves and (*Gauhn & Klein*), 66 East Main, house East avenue near Arnold park
- Klein George W. clerk, boards 106 Tappan
- Klein Henry, shoemaker, b. St. Joseph near Norton [Paul]
- Klein Henry (*Klein & Hofheinz*), h. 139 N. St.
- Klein Isaac, clerk, 42 State, bds. 9 Marshall
- Klein Jacob, telegrapher, Osburn House, b. 9 Marshall
- Klein Jacob, laborer, boards 48 German
- Klein Jerome, baker, house 128 South av.
- Klein John, sawyer, h. Rowe c. Straub alley
- Klein Mary Mrs. saloon, 298 N. Clinton, h. do.
- Klein John, grocer, 83 Frances, house do.
- Klein John, machinist, house 50 German
- Klein John, saloon, 101 Allen, house do.
- Klein John C. painter, 188 State, h. 5 Linden
- Klein Julius, baker, 154 W. Main, bds. do.
- Klein Lawrence, house 296 North Clinton
- Klein Lawrence, laborer, boards 10 Kondolf
- Klein Louis, shoemaker, 124 Front, house North Clinton near Norton
- Klein Mary A. widow, house 106 Tappan
- Klein Michael, shoemaker, 27 Walbridge's block, house 31 Galusha
- Klein Peter A. blacksmith, 125 North St. Paul, house 34 Rauber
- Klein Peter C. carpenter, house 27 Campbell
- Klein Samuel, boards 9 Marshall
- Klein Samuel, tailor, house 41 Atwater
- KLEIN & HOFHEINZ** (*H. Klein and J. Hofheinz*), bottlers, 6 Exchange place.—
See page 563
- Kleindienst Catharine, stitcher, b. 65 Orchard
- Kleindienst Jacob, boiler maker, house 65 Orchard [5 Bay]
- Kleiner George, laborer, 144 E. Main, house
- Kleinhans Adam K. tailor, h. 12 Shamrock
- Kleinhans Anna M. widow, house 28 Morris
- Kleinhans Anton, clerk, Franklin cor. North St. Paul, boards 28 Morris
- Kleinhans Frederick, shoemaker, b. 28 Morris
- Kleinhans Jacob, butcher, 182 North St. Paul, boards 28 Morris
- Kleinhans John, teamster, house 49 Oakman
- Kleinhans Peter, butcher, h. 109 W. Maple
- Kleinman Friederlein, mason, h. 38 Madison
- Kleisle John, cigarmaker, boards 21 Lowell
- Kleisle Margaret, tailoress, boards 21 Lowell
- Kleisle Simon, grocer, 21 Lowell, house do.
- Kleisly George, brakeman, house 14 Syke
- Kleisly Mary, widow, h. Childs n. W. Maple
- Klem Alphonse, salesman, 53 East Main, h. 108 Oak
- Klem Anthony, laborer, b. r. 17 Mt. Hope av.
- Klem Barnard, farmer, house Goodman cor. Leighton avenue
- Klem Catharine, widow, boards 32 Herman
- Klem George, confectioner, 165 East Main, house 40 North av.
- Klem Henry, farmer, boards Goodman cor. Leighton avenue [rence]
- Klem John, clerk, 165 East Main, h. 11 Law-
- Klem Magdalena, widow, bds. 22 alley rear 17 Mt. Hope avenue
- Klem Roman B. clerk, 53 East Main, boards Goodman cor. Leighton av. [h. do.]
- Klemm Catharine Mrs. saloon, 116 W. Main,
- Klemm Joseph, clerk, 116 W. Main, bds. do.
- Klier Joseph, shoecutter, 55 Mill, h. 9½ Wilder
- Klier J. Baptist, shoemaker, 231 Brown, h. 19 Syke
- Klimm Joseph, removed from city [132 do.]
- Klimm Michael, wagonmaker, 134 Lyell, h.
- Klinck Owen K. agent, 24 State, h. at Lyons
- Kliner Jacob, farmer, h. rear Webster road near Bay [road]
- Kliner John, milkman, house Bay n. Webster
- Klingelhafer John, mason, h. 61 North av.
- Klingelhafer Libbie, widow, b. 61 North av.
- Klingelhoef Conrad, laborer, h. 46 Kelly
- Klingelhoef John, boards 46 Kelly
- Klingelschmidt John, tailor, house 65 Baden
- Klingler August, tailor, house 218 N. Clinton
- Klingler Henry, tailor, house 9 Clifford
- Klingler John B. foreman, 179 North St. Paul, house 26 Almira [ton, h. do.]
- Klingler John M. periodicals, 261½ N. Clin-
- Klingler Joseph, tailor, boards 9 Clifford
- Klingler Mary, cook, 7 Mumford, boards do.
- Klingler Philip, tailor, b. 218 N. Clinton
- Klingler Sebastian, saloon, 184 St. Joseph, house do. [69 Scrantom]
- Klinkert William, cooper, 5 Thompson, h.
- Klinkhammer Henry, carpenter, Colvin near West Maple, house 122 West Maple
- Klinkhammer Nicholas, butcher, boards 122 West Maple [h. 86 Hickory]
- Klinzing Louis, polisher, 179 North St. Paul,
- Klinzing Louis Jr. clerk, 51 Monroe av. bds. 86 Hickory
- Klipp George, potter, bds. 33 Campbell
- Klipp John, cigarmaker, 6 North Water, b. 33 Campbell [33 Campbell]
- Klipp Philip P. pottery, 151 West av. house

- Klippert Louisa, widow, house 204 North
 Klix August, laborer, house 14 Holland
 Klix William, mason, house 6 Baden
 Klonik Simon, peddler, house 46 Catharine
 Klonik Z. peddler, house 77 St. Joseph
 Klos George M. shoemaker, 92 State, boards
 N. Clinton near Bloomingdale av.
 Klos Peter, laborer, house N. Clinton near
 Bloomingdale avenue
 Kloter Frank S. salesman, h. 122 Hudson
 Klotz Benjamin, stonecutter, 54 Fitzhugh,
 house 12 Hanover [40 Broadway
 Klotz John, shoemaker, 75 N. Water, boards
 Kluber George F. chairmaker, 184 State, h.
 32 Frances
 Klubertanz Frederick A. clerk, bds. 54 Weld
 Klubertanz George, teamster, h. 54 Weld
 Klubertanz Lawrence J. laborer, h. 52 Weld
 Kluepfel George, gardener, b. 150 S. St. Paul
 Kluepfel Hypolith, gardener, h. Straub alley
 near McCracken
 Klug Adam, laborer, house 117 Meigs
 Kluh Lawrence, laborer, Vacuum Oil Works,
 house 40 Seward
 Knakstett Henry, machinist, Brown corner
 Jones, house 97 Jay [h. 137 Jones
 Knapp Andrew J. foreman, 87 North Water,
 Knapp Annie, widow, house 84 Childs
 Knapp A. G. principal Munger School, No.
 13, house 32 Hickory
 Knapp Dwight, conductor, N. Y. C. R. R.
 house 32 Elizabeth [Clinton
 Knapp Eliphalet P. bootmaker, house 87 N.
 Knapp Evelina, widow, boards 32 Hickory
 Knapp Francis, laborer, house 15 Hanover
 Knapp Francis, tailor, Thomas n. Clifford,
 house do.
 Knapp Frank, laborer, h. Moulson near Jay
 Knapp Frank, carver, boards 41 Herman
 Knapp Frank J. salesman, 14 Front, house
 37 Hamilton place
 Knapp Frederick M. deceased July 21, 1875
 Knapp George, machinist, bds. 11 Fitzhugh
 Knapp George J. clerk, 36 E. Main, bds. 84
 Tremont [41 Hand
 Knapp George J. (*Knapp & Fisher*), house
 Knapp George H. blacksmith, bds. 36 North
 Washington
 Knapp H. B. Mrs. widow, h. 121 West av.
 Knapp John O. clerk, boards 36 South av.
 Knapp J. Adam, tailor, 71 Joiner, house do.
 Knapp Kittie E. Miss, boards 30 George
 Knapp Lawrence, hairdresser, 7 Wilder, b.
 34 do.
 Knapp Lovisa S. teacher Munger School,
 No. 13, b. 34 N. Union
 Knapp Ludwig, finisher, 22 S. St. Paul, bds.
 16 Rhine
 Knapp Mary Ann, widow, h. 195 N. St. Paul
 Knapp Mary A. widow, house 41 Herman
 Knapp Michael, carpenter, house 4 Hope
 Knapp Moses T. painter, h. 195 N. St. Paul
 Knapp Peter, deceased June 27, 1875
 Knapp Philip, house rear 76 St. Joseph
 Knapp Philip jr. clerk, bds. r. 76 St. Joseph
 Knapp Samuel J. machinist, River c. North
 Water, boards 195 N. St. Paul
 Knapp Victor, grocer, 36 South av. house do.
- Knapp William H. removed to Rochester,
 Minnesota
K NAPP & FISHER (*G. J. Knapp and O.
 Fisher*), wood dealers, N. St. Paul opp.
 Ward, 35 Pinnacle av. and 1 Arcade.—
See page 598 [boards 18 Hawkins
 Knatz Ferdinand, machinist, Court c. Stone,
 Knatz Jules, moulder Brown's race n. Fur-
 nace, house 18 Hawkins [non av.
 Knauf Magnus, mason, h. Lewis n. Mt. Ver-
 Knauss Charles H. removed to Clifton
 Springs
 Kneale Albert J. mason, boards 66 Munger.
 Kneale Henry H. mason, house 130 Meigs
 Kneale William, mason, house 66 Munger
 Kneale William, carpenter, house rear 85
 Broadway
 Kneale William C. removed to Bergen
K NEBEL CHRISTIAN, architect, 64 Ar-
 cade, house 8 Martin.—*See page 511*
 Knebel Frederick W. carriage painter, 3
 Canal, house 4 Martin [8 Martin
 Knebel Oscar W. architect, 64 Arcade, bds.
 Kneen Thomas, blacksmith, house 6 Delevan
 Kneen Wm. T. tinsmith, boards 6 Delevan
 Knell Frank, grocer, 140 Hudson, house do.
 Knell Odillia, widow, house 133 Jay
 Knickerbocker Edgar, lawyer, house Lake
 av. n. tollgate
 Knickerbocker James H. engraver, 23 West
 Main, b. 12½ Alexander
 Knickerbocker Judson, salesman, house 14
 Alexander [Caledonia avenue
 Knickerbocker Mary A. widow, house 26
 Kniebel Charles, laborer, house 71 Kelly
 Knight Adam, machinist, ft. Platt, house 436
 Brown [McCracken
 Knight Albert M. fireman, bds. Thorn near
 Knight Arthur, waiter, Clinton Hotel, b. do.
 Knight August, cabinet maker, Jay c. Erie
 canal, boards 133 Jay
 Knight Charles, boards Perkins n. Lake av.
 Knight Edward J. teamster, b. 22 Lake av.
 Knight Elizabeth, deceased November, 1875
 Knight Frank, chairmaker, b. r. 2 Perkins
 Knight George, painter, 100 S. St. Paul, h.
 195 Brown [N. Ford
 Knight George E. spoke maker, boards 8
 Knight Horton, brakeman, house 310 North
 Knight Jacob, cooper, 1 St. James pk. h. 133
 Jay
 Knight James A. removed from city
 Knight Letitia, widow, house 141 E. Main
 Knight Louisa Mrs. seamstress, Orphan Asy-
 lum, Hubbell park, boards do.
 Knight Mary, carpet sewer, 14 Exchange, h.
 18 Canal [Paul, h. 22 Lake av.
 Knight Michael, shoemaker, River n. N. St.
 Knight Philip, cooper, West n. Lyell, house
 63 Lorimer [rear 2 Perkins
 Knight Valentine, laborer, lower falls, house
 Knight Walter, deceased May, 1875
 Knight William, house 133 Plymouth avenue
 Knipf Jacob, mason, house 49 Gibbs
 Knipf John, tobacco worker, bds. 49 Gibbs
 Knipper George, cabinetmaker, 71 North St.
 Paul, house 80 Orange [158 Jay
 Knipper John, butcher, 26 Mumford, house

HENRY C. WISNER,

THE CELEBRATED (SOLE AGENCY) "MOSSELL
 WARE"---No. 33 STATE STREET.

Knipper Peter, shoemaker, N. Water c. Andrews, boards 223 Brown
 Knitta John, moulder, house Miller near Bay
 Knittel Isidore, laborer, boards Stewart near North avenue
 Knittel Victor, removed to Lyons
 Knittel Wendelin, laborer, West av. corner Trowbridge, bds. Stewart n. North av.
 Knitter Hermann, laborer, house 2 Thomas
 Knobles Anthony, tanner, 37 N. Water, h. Murray corner Railroad [Murray
 Knobles Henry, blacksmith, 129 Mill, b. 10
 Knobles Joseph W. machinist, house Lyell near railroad [St. Joseph
 Knobloch George, blacksmith, h. Huron n.
 Knoefel John, teamster, house Parkland near Norton [house 86 Strong
 Knoller Charles, carriage trimmer, 3 Canal,
 Knoller Charles L. removed to Medina
 Knop Frederick, laborer, house 110 Chatham
 Knop Henry, laborer, house 11 Shamrock
 Knop John, laborer, house Caroline n. Meigs
 Knope Anthony T. grocer, Saratoga av. near Montrose, house do.
 Knope Joseph, grocer, 107 Oak, house do.
 Knopf Caspar, cooper, house 108 Oak
 Knopf Henry, baker, 307 State, h. 108 Oak
 Knorr Jacob, carpenter, boards 20 Joiner
 Knorr Jacob, engineer, 162 S. St. Paul, bds. rear 72 Franklin
 Knorr John, maltster, house rear 72 Franklin
 Knorr John jr. brewer, foot Cliff, house do.
 Knowles Elizabeth, widow, h. 49 Tremont
 Knowles George H. laborer, City Hospital, boards do.
 Knowles Helen, widow, h. 126 Monroe av.
 Knowles Isaac C. physician, 12 S. St. Paul, house 96 do.
 Knowles John E. clerk, 54 Lyell, h. 12 Moore
 Knowles John W. tinsmith, 13 South av. h. 95 Reynolds
 Knowles Samuel, hackman, b. 106 Tremont
 Knowles Thomas, hackman, h. 113 Adams
 Knowles Thomas, teamster, h. 106 Tremont
 Knox Walter P. shoemaker, 15 Mill, boards 16 North Clinton [near Bay
 Knuetter John, laborer, 20 Court, h. Miller
 Knuth Christian, laborer, house 24 Vienna
 Knuth John, laborer, house 5 Clifford
 Knuth John, laborer, house 21 Hoeltzer
 Knuth Mary, widow, boards 48 Hoeltzer
 Kobbe Henry, druggist, N. Clinton corner Atwater, house 12 Atwater [Hand
 Kobely Henry, tinsmith, 144 E. Main, b. 7
 Koch Ambrose, tailor, h. 190 Pinnacle av.
 Koch Charles, packer, 65 West Main, house 41 McDonald avenue
 Koch Christian, laborer, house 17 Morris
 Koch Frank, optician, 179 N. St. Paul, h. 49 Rauber
 Koch George, hairdresser, 90 Mill, house 172 North Clinton
 Koch Henry, laborer, house 31 Mark
 Koch Henry G. butcher, 78 Monroe avenue, boards 69 Chestnut
 Koch John, laborer, 184 State, house Lewis near Mt. Vernon av. [91 Wilder
 Koch John G. cooper, Butler c. Charles, h.

Koch Michael, removed to Penfield
 Koch Michael, removed from city
 Koch Paul, teamster, house 1 Syke
 Koch Pauline, widow, house 47 Henry
 Koch see Cook
 Kochems John, butcher, 136 East Main, bds. 32½ Scio
 Kochems Joseph, removed to Buffalo
 Kocher Jonas H. cartman, house 14 Green
 Kodisch Nicholas, cook, 24 Franklin, b. do.
 Kodisch Henry, saloon, 8 Lowell, h. do.
 Kodish John, saloon, 276 N. Clinton, h. do.
 Kodish John 2d, frame maker, 38 Gorham, house 22 Hawkins
 Koehler Andrew (*Reinhardt & Koehler*), North avenue c. Casper, b. do. [Thomas
 Koehler Andrew, miller, at C. B. Hill's, h. 8
 Koehler Bankraz, fireman, Exchange opp. Troup, h. Hick n. railroad [railroad
 Koehler Bernard, fireman, house Hague n.
 Koehler Edward, shoemaker, b. 65 Ontario
 Koehler Frederick, boots and shoes, 235 E. Main, h. 83 Tappan [h. 14 Tonawanda
 Koehler Henry, bookbinder, 27 Smith's blk.
 Koehler Isaac, clerk, 10 Mill, b. 50 Howell
 Koehler Jacob, house rear 212 N. Clinton
 Koehler John, carpenter, 84 South av. h. do.
 Koehler John H. pattern fitter, 187 W. Main, house 285 Brown
 Koehler Joseph, tailor, house 33 Magne
 Koehler Julius, porter, 42 State, h. 166 North Clinton
 Koehler Mina, midwife, h. 166 N. Clinton
 Koehler Moses, shoemaker, 48 Monroe av. house 50 Howell
 Koen Frank, brewer, boards 48 Frank
 Koenig George, clerk, b. 16 McDonald av.
 Koenig Louis, carpenter, h. 16 McDonald av.
 Koenitz Otto Von, artist, 83 East Main, h. do. Lowell [avenue, boards do.
 Koenne Gustav, sausage maker, 4 West
 Koepke Christopher, driver, 117 N. Clinton, house 144 St. Joseph
 Koerner Christian, hairdresser, 43 South St. Paul, boards 5 Mauder's park
 Koerner Daniel, laborer, h. 5 Mauder's park
 Koerner Edward, principal St. John's German school, Buchan pk. h. 171 St. Joseph
 Koerner Jacob, moulder, 187 W. Main, h. 41 Hudson
 Koerner Mary, widow, house 301 Brown
 Koerner Mary Miss tailoress, b. 301 Brown
 Koerner Philip, moulder, 187 W. Main, bds. 301 Brown [b. 5 Mauder's park
 Koerner Robt. marble cutter, 122 S. St. Paul,
 Koerner William, house 151 North Clinton
 Koester John, laborer, house 59 Sanford
 Koester John B. piano maker, 4 Hill, bds. 59 Sanford [house do.
 Koesterer Henry, grocer, 116 North av.
 Koesterer Jerome C. cigar maker, bds. 116 North avenue [65 do.
 Koesterer John C. grocer, 41 Andrews, h.
 Koeth August M. city assessor, City Hall, h. 246 North Clinton
 Koeth George J. mason, h. 7 McDonald av.
 Koeth John, packer, 74 State, h. 77 Martin
 Koeth John jr. teamster, boards 77 Martin

Kogler George, cutter, 25 Mill, h. Scio cor. Huron [61 Scio
 Kogler Geo. jr. clerk, 130 East Main, boards
 Kohl Charles, grocer, Lowell cor. Martin, house do.
 Kohler Catharine, widow, h. 94 W. Maple
 Kohler Charles S. pastor, Church of Reformation, house 80 Court
 Kohler Emma, seamstress, b. 94 W. Maple
 Kohler Frederick, carpenter, boards 3 Tyler
 Kohler Jacob, machinist, 3 Canal, house 19 Lewis
 Kohler John, carpenter, h. Miller near Bay
 Kohler Louis, laborer, bds. 94 West Maple
 Kohler Robert, carpenter, 4 College avenue, house 28 Second avenue
 Kohler see Kochler and Kahler
 Kohlman Frank, carpenter, b. North Clinton near Blumenthal [n. Blumenthal
 Kohlman Joseph, musician, h. N. Clinton
 Kohlman Nicholas, hairdresser, Brackett House, boards North Clinton
 Kohlman William, shoemaker, bds. North Clinton near Bloomingdale avenue
 Kohlmeir Jacob, laborer, house 119 Campbell near Childs
 Köhlmeir Joseph, blacksmith, h. 96 Orchard
 Kohlmetz Charles E. blacksmith, boards 18 Martin
KOHLMETZ HENRY, machinist, blacksmith, and iron fence manuf., 121 North Water, house 18 Martin.—See page 677
 Kohlmetz William T. tailor, 35 State, house 3 Catharine
 Kohmann Dorothy, widow, h. 6 Campbell
 Kohn Edward, salesman, 36 W. Main, bds. 47 Andrews
 Kolb Elizabeth, widow, house 5 Union alley
 Kolb Eva M. Miss, boards 5 Union alley
 Kolb Frank J. cutter, boards 5 Union alley
 Kolb George, laborer, house 5 Flower
 Kolb George, tailor, house 6 Almira
 Kolb George G. cutter, Mill c. Mumford, b. 38 North Clinton [avenue
 Kolb George M. cutter, 25 Mill, h. 51 North
 Kolb Jacob (*Kolb & Oberg*), house 178 North Clinton [38 N. Clinton
 Kolb Jacob 2d, cutter, Mill c. Mumford, b.
 Kolb Jacob, carpenter, 3 Saratoga avenue, house 8 Sherman
 Kolb Jacob, porter, 24 Franklin, boards do.
 Kolb Joseph, tailor, house 235 N. Clinton
 Kolb Louis, clerk, 9 E. Main, bds. 178 North Clinton
 Kolb Martin, tailor, house 149 St. Joseph
 Kolb Michael (*Kolb, Rosenberg & Co.*), house 38 North Clinton
 Kolb Philip H. cutter, 74 Mill, bds. 86 State
 Kolb, Rosenberg & Co. (*M. Kolb, H. Rosenberg and J. Bühler*), clothing, Mumford corner Mill [5 Flower
 Kolb Susan Miss, tailoress, 48 Martin, boards
 Kolb & Oberg (*J. Kolb and O. Oberg*), tailors, 9 East Main [house 2 Huntington
 Kolk John, laborer, N. Y. C. R. R. depot,
 Kolkman Diana, widow, h. 129 St. Joseph
 Kolkman Henriicus, shoemaker, 129 St. Joseph, boards do.

Kolkman Henry, shoemaker, 129 St. Joseph, boards do.
 Kolkman John, shoemaker, 129 St. Joseph, house do. [house do.
 Kollman George, saloon, 102 N. Clinton,
 Kollofski Alexander C. furrier, 92 State, h. 204 N. St. Paul [b. 204 N. St. Paul
 Kollofski Bernhard R. hats, &c. 92 State,
 Komenski Davis, peddler, 30 Joiner
 Konath Ernestina, widow, boards 93 Wilder
 Konath Gottlieb, grocer, 128 Lyell, h. do.
 *Kondolf Anthony, saloon, Ames n. Jay, h. do.
 Kondolf Henry, grocer, Ames n. Jay, h. do.
 Kondolf Henry jr. carpenter, 8 Hill, h. Ames
 Kondolf Lucy, clerk, Ames n. Jay, bds. do.
 Kondolf Matthias, stove manuf. h. 114 Oak
 Konitz Henry, tailor, house 2 Irondequoit
 Konitz Herman, painter, h. North av. n. Bay
 Konrad Frank, laborer, 159 State, house 14 Hoeltzer [49 St. Joseph
 Kooman Peter, carpenter, Minerva alley, h.
 Koomer John, upholsterer, 73 State, house 124 Scio [bds. 56 East av.
 Kooms William D. salesman, 73 East Main,
 Kooper George, house 9 German
 Koplín John, cabinetmaker, 3 Canal, b. 121 Alexander [boards do.
 Kopp Rudolph, sausagemaker, 32 Front,
 Koppe Eliza, dressmaker, bds. 54 Asylum
 Koppe Kate, housekeeper, bds. 86 East av.
 Koppelle John, shoemaker, 81 North Water, house 231 St. Joseph [n. Edward
 Kopenhagen Gerhard, laborer, h. Alphonse
 Koppyan Peter, machinist, 81 N. Water, h. Norton near St. Joseph
 Koretz Frank, removed to Buffalo
 Kornmaier Sylvester, student, h. 12 Edmonds
 Kortakauer Christian, cooper, 1 St. James park, house 133 Lyell [h. 11 West
 Kortakauer Daniel, cooper, West near Lyell,
 Kortright John W. carpenter, h. 14 Market
 Kortright Margaret M. tailoress, h. 14 Market
 Koser J. George, cooper, West n. Lyell, house 19 Lime [av. h. 5 Clarissa
 Kostbahn Gustav, grocer, 69 Mount Hope
 Kostbahn Gustav jr. carver, bds. 5 Clarissa
 Kovitz William, laborer, h. 151 N. Clinton
 Koza George, shoemaker, 343 State, h. do.
 Kracht Joseph, laborer, house Elm n. Bay
 Krackel Frank, shoemaker, b. 8 Cayuga pl.
 Krackel John, carpenter, bds. 8 Cayuga pl.
 Krackel John J. teamster, h. 8 Cayuga place
 Kraemer Louis, porter, 36 Exchange, house 19 Catharine [Hand
 Kraft Dominick (*Kraft & Siebert*), house 32
 Kraft Frank A. stovemounter, 187 W. Main, boards 67 Front
 Kraft George, deceased Sept. 10, 1875
 Kraft George, hairdresser, h. 20 Campbell
 Kraft Louis, shoemaker, 100 Front, house North avenue n. Jennings [Campbell
 Kraft Martin, tailor, 100 State, house 129
 Kraft Wilhelm, tailor, 124 West Main, bds. 67 Front
 Kraft William, laborer, house 52 Herman
KRAFT & SIEBERT (*Dominick Kraft and Charles Siebert*), carpenters and builders, 5 Ringelstein alley.—See page 588

Kraft, see Craft
 Kraftzich John, laborer, house 59 Herman
 Krahl Frederick, tailor, house 9 Hawkins
 Kramer Christian, chairmaker, Lower Falls, house 16½ Thorn [64 Martin
 Kramer Eugene, laborer, 158 Lake av. house
 Kramer George, bookkeeper, 6 S. St. Paul, boards 206 N. Clinton [Lake av.
 Kramer George A. clerk, 120 State, bds. 115
 Kramer John, mason, house 73 Whitney
 Kramer Joseph, teamster, house 28 German
 Kramer Joseph, 2d, laborer, house r. North Clinton near Norton [16½ Thorn
 Kramer Louis, trunkmaker, foot Rowe, bds.
 Kramer Mary, widow, house 28 German
 Kramer Matthias, confectionery, 120 State, house 115 Lake avenue
 Kramer Nicholas, carpenter, Walnut near Campbell, house 13 Campbell
 Kramer Philip, tailor, 19 Sellinger, h. do.
 Kramer Valentine, grocer, 206 N. Clinton, house do.
 Kramer, see Cramer and Kraemer
 Kramich Henry, laborer, house 19 Webster
 Kramp Jacob, shoemaker, 92 State, house 252 North Clinton [Clinton
 Kramp Varonesa Mrs. widow, house 252 N.
 Krank August, stovemounter, 8 Hill, house 41 Oakman [Oakman
 Krank August jr. stovemounter, 8 Hill, b. 41
 Krank George, cigarmaker, 41 Oakman, h. do.
 Krank Joseph K. stovemounter, boards 41 Oakman [152 N. Clinton
 Krank Joseph K. salesman, 53 E. Main, h.
 Krapf Bartholomay, hairdresser, 252 State, house 45 Kent
 Krapf Caspar, farmer, house 13 Hebard
 Krapf George, hairdresser, 1 South St. Paul, boards 13 Hebard
 Krapp Ernest, carpenter, boards 49 Lowell
 Krapp Frederick, T. cigar manuf. 49 Hanover, house do.
 Krapp Gustavus W. carpenter, bds. 19 Lowell
 Krapp Helmuth J. carpenter, h. 49 Lowell
 Krapp John F. carver, boards 49 Lowell
 Krapp Mary, tailoress, boards 49 Lowell
 Krase John, laborer, house 38 Sellinger
 Kratt Martin, peddler, h. Goodman n. Bay
 Kratz Charles H. clerk, 2 State, b. 67 Meigs
 Kratz Fred. caulker, house r. 29 Broadway
 Kratz John, boatbuilder, house 67 Meigs
 Kratz John S. boatbuilder, h. 4½ Comfort
 Kraus Emanuel, mason, house 59 Kelly
 Kraus Michael, laborer, h. Bernard n. Hudson
 Kraus Nicholas, machinist, 100 S. St. Paul, house 2 Bond
 Kraus Peter, grocer, Jay opp. Ames, h. do.
 Krause Balzar, shoemaker, house 93 Cady
 Krause Edward, shoemaker, 15 Mill, house 31 Sellinger
 Krause Fred. cabinetmaker, h. 20 Hawkins
 Krause Louis, clerk, post office, house 102 Mt. Hope avenue
 Krause Michael, mason, house 1 Orange
 Kraushaar Alfred, shade painter, 9 W. Main, boards 97 Mount Hope avenue
 Krausneck Martin, chairmaker, h. 16 Thorn
 Krauss John, removed to New York city

Kraut Annie C. dressmaker, 42 Lancaster, house do.
 Kraut Henry C. painter, house 42 Lancaster
 Krautwurst Balzer, shoemaker, 83 N. Water, house 37 Hand [Hudson
 Krautwurst George, clerk, 19 Mill, bds. 105½
 Krautwurst George, cartman, h. 70 Martin
 Krautwurst George W. machinist, 129 Mill, house 30 Hawkins
 Krautwurst John, shoemaker, h. 30 Scrantom
 Krautwurst John A. cutter, 24 State, h. 105½ Hudson
 Krebs Eliza, widow, house 32 Kirk
 Krebs Frank, saloon, 13 S. St. Paul, house 29 Cherry [h. 385 Brown
 Krebs John, carriage painter, 47 S. St. Paul,
 Krebs Philip, laborer, house 35 Sanford
 Kreckel Frank, shoemaker, 100 Front, bds. 8 Cayuga place [Cayuga place
 Kreckel John J. teamster, 102 Exchange, h.
 Kreckman Frederick, flour and feed, 51 North avenue, house do. [87 North av.
 Kreckmann Charles, tailor, 92 Arcade, house
 Krefit Louis, laborer, Brown c. Wentworth, house railroad alley near North York
 Kreig Andrew, machinist, 124 Mill, house 57 Oakman
 Kreig August, laborer, house 39 Cole
 Kreig Constantine, sawyer, bds. Leavenworth alley near Champion
 Kreig Felix, baker, house 109 Wilder
 Krein Stephen, removed from city
 Kreiser John, cooper, 13 Lime, house do.
 Kreiser Julius A. mason, house 15 Lime
 Krepp Adam, brickmaker, house 156 North
 Kress August, carver, 71 N. St. Paul, boards 32 Grand
 Kress Catharine Mrs. h. Thomas c. Clifford
 Kress George, carpenter, house 64 Ontario
 Kress George jr. removed to California
 Kress John C. laborer, house 131 Scio
 Kress Joseph, mason, h. Bernard n. Thomas
 Kress Otto, driver, Röch. Brewing Co. house foot Cliff
 Kress Valentine, carpenter, house 32 Grand
 Kretschmer August, potter, bds. 29 Delevan
 Kretschmer Simon, tinsmith, 36 Tappan, h. Augusta near North Union
 Kreuser Amelia Miss, seamstress, b. 51 Nassau
 Kreuser Catharine, widow, house 51 Nassau
 Kreuser Charles, druggist, 110 North Clinton, house 18 Cole [64 Hollister
 Krieg Augustus, currier, 51 N. Water, house
 Krieg Benedict, tailor, house Cayuga place near Meigs
 Krieg Boniface, tailor, house 268 N. Clinton
 Krieg Leopold, boards 9 Buchan park
 Krieg Marcell, confectionery, 199 N. Clinton, house do. [North Clinton
 Krieg Martin, shoemaker, 87 N. Water, b. 302
 Krieg Valentine, warehouseman, Irving Mills, house 302 North Clinton
 Krieg Valentine, moulder, 150 North Water, house 300 North Clinton [Joseph
 Krieg Wendelin, marble cutter, house 114½ St.
 Krieger Adam, teamster, b. 139 Pinnacle av.
 Krieger Amelia, dressmaker, boards 28 Weld
 Krieger Catharine, widow, house 28 Weld

- Krieger Eliza, widow, h. Bond near Grand
 Krieger John, tanner, house 56 Vienna
 Krieger Wm. teamster, house Henrietta av.
 near Allmeroth
 Kriskche John, laborer, boards 13 Herman
 Kriskche Wm. shoemaker, house 13 Herman
 Krofke Wm. professor, 17 Andrews, b. 7 Ely
 Kron George, farmer, h. Sawyer n. Genesee
 Kroner Annie, domestic, boards 23 Prince
 Kronsbein Frederic, cigar box maker, 149 N.
 Water, house 26 St. Joseph
 Kropp Antonia Miss, tailoress, bds. 1 Kelly
 Kropp George, shoemaker, 62 Wilder, h. do.
 Kropp Regina, widow, house 1 Kelly
 Krous Ferdinand, laborer, bds. 2 North York
 Krueger Henry, laborer, house 7 Drayton
 Krug Henry, saloon, 154 North av. house do.
 Kruger Charles, gardener, West av. n. North
 York, house do. [near North
 Kruger Christopher, laborer, house Channing
 Kruger John, laborer, boards 7 Drayton
 Krumbein Jacob C. cabinetmaker, house r.
 50 West Maple
 Krumbein Rudolph, removed to Bath
 Krumbein Rudolph H. cabinetmaker, 22 S.
 St. Paul, boards 50 West Maple
 Krumbein Frederick, cabinetmaker, boards
 rear 50 West Maple
 Krus Katharina, widow, house 7 Buchan pk
 Kruse Frederick, laborer, house Field near
 Pinnacle avenue
 Kruse John, mason, house 17 Hoeltzer
 Kübel John, engineer, Roch. Brewing Co.
 foot Cliff, house 39 Magne
 Kubitz Charles, laborer, house 18 Widman
 Kubitz Charles, laborer, house 14 Maria
 Kubitz Ferdinand, laborer, house 14 Maria
 Kubitz Frederick, laborer, house Thomas n.
 Clifford
 Kuchke Wm. laborer, house 43 Henry
 Kuder Andrew, engineer, 38 Gorham, bds.
 156 North Clinton [house do.
 Kuder Christian, cigar maker, 117 Saxton
 Kuder Geo. laborer, house 58 Martin
 Kuebel Joseph, shoemaker, 92 State, h. 303
 North Clinton
 Kueblar John G. cigars, 216 West av. h. do.
 Kuefer Benedict, saloon, 32 St. Joseph, h. do.
 Kuefer Frederick C. grocer, 32 St. Joseph,
 boards do.
 Kuefer Wm. J. clerk, 32 St. Joseph, bds. do.
 Kuehler August, baker, 80 Hudson, h. do.
 Kuehles Conrad, foreman, 184 State, house
 45 Kelly
 Kuehn John, wool picker, 23 North Water
 Kuehne Hugo G. teacher of German, public
 schools, house 118 South avenue
 Kuehrman Gottlieb, laborer, house 2 Putnam
 Kuehrman Wm. carpenter, boards 2 Putnam
 Kuemerling John, carrier, 31 North Water
 Kuen Mary Miss, boards 38 Chatham
 Kuenemann John T. carpenter, house 198 N.
 Clinton [house do.
 Kuenemann Lillie, milliner, 198 N. Clinton
 Kuenemann Mary L. Miss, milliner, 198 N.
 Clinton, boards do.
 Kuenzel Herman, bookkeeper, 179 N. St.
 Paul, boards Andrews cor. N. Water
 Kuenzi Henry, carriage maker, b. 66 Delevan
 Kuenzi Samuel, grocer, 66 Delevan, h. do.
 Kueter Charles, coachmaker, 3 Canal, bds.
 28 Hoeltzer
 Kugler George, cutter, 74 Mill, h. 32 Kelly
KÜHLMAN JOHN, costumer, 3 Oregon,
 h. house do.—See page 544
 Kuhnman Anthony, teamster, house 27 Henry
 Kuhnman Joseph, teamster, house 10 Vienna
 Kuhnman Peter, shoemaker, 20 Catharine, h.
 11 Henry [Alphonse n. Henry
 Kuhn Andrew, varnisher, 141 N. Water, b.
 Kuhn Catharine, widow, h. Alphonse near
 Henry [Henry
 Kuhn George, carpenter, boards Alphonse n.
 Kuhn Henry, cartman, house 19 Hoeltzer
 Kuhn Herman, cigarmaker, Mill c. Factory,
 house 12 Elizabeth place [n. Henry
 Kuhn Jacob, laborer, 20 Court, b. Alphonse
 Kuhn John, solecutter, 75 N. Water, h. Al-
 phonse near Henry [h. 158 Jay
 Kuhn Joseph, cigar maker, 48 Exchange,
 Kuhn Nicholas, teamster, h. 291 N. Clinton
 Kuhn Peter, laborer, h. Bay near Goodman
 Kühn Richard, butcher, 42 Front, h. 24 Uni-
 versity avenue [Weld
 Kuhn Robert, foreman, 14 Mumford, h. 23
 Kuhn Walter, sashmaker, b. 14 North York
 Kuhn see Coon
 Kubnert Fred. W. removed to Irondequoit
 Kuichling Emil, civil engineer, R. W. W.
 City Hall, b. 76 N. Clinton [h. do.
 Kuichling Louis, physician, 76 N. Clinton,
 Kuiper Albert R. blacksmith, h. 74 Chatham
 Kujawski Charles, carpenter, h. 19 Scramton
 Kulzer Andrew, laborer, house 4 Bond
 Kümmerer Louis, yardman, Brackett House,
 boards do. [house 85 Meigs
 Kummerow Chas. E. teamster, 149 Exchange,
 Kummerow Wm. H. well-sinker, house 62
 West Maple
 Kunow August, laborer, house 29 Baden
 Kunow William, laborer, house 20 Joiner
 Kuntz Barnard, boards 64 Delevan
 Kuntz David, laborer, house 64 Delevan
 Kuntz Frederick, turner, boards 64 Delevan
 Kuntz Peter, moulder, 8 Hill, house 7 Tona-
 wanda [8 Park avenue
 Kunz Jacob, turner, Rowe n. Lake av. h.
 Kunz John, laborer, h. Bay corner Goodman
 Kunz John, carpenter, house 71 Whitney
 Kunzer Caspar, laborer, house Stewart near
 North av. [b. Stewart n. North av.
 Kunzer Stephen, shoemaker, 81 N. Water,
 Kunzmann George, packer, Model Mills, h.
 64 Herman [b. Plymouth av. c. Clarissa
 Kupfer Henry, glassblower, 178 Plymouth av.
 Kupfer Joseph, glassblower, 178 Plymouth
 avenue, boards 93 Reynolds
 Kupper Henry, laborer, house 90 Wilder
 Kupper John, laborer, house 128 Wilder
 Kupperschmidt Matthias, mason, house 11
 Sellinger
 Kurfuerst Adolphus, clerk, boards 1 Tappan
 Kurfuerst Elizabeth, widow, house 1 Tappan
 Kurrasch Ferdinand F. shoemaker, house 110
 St. Joseph
 Kurtz Conrad, tailor, house 18 Joiner

Kurtz Conrad jr. finisher, 74 State, house 8 Marietta [house 146 Jay
 Kurtz Edward, cabinetmaker, Jay st. bridge,
 Kurtz Frederick, blacksmith, h. 41 Bartlett
 Kurtz Frederick G. filter maker, boards 115 Pinnacle avenue [boards do.
 Kurtz Henry, bartender, 111 North St. Paul,
 Kurtz John, harness maker, bds. 115 Pinnacle avenue
 Kurtz John M. blacksmith, h. 94 N. Clinton
 Kurtz Vitus, optician, house 13 Granger
 Kurz Frederick, tailor, 28½ East Main, bds. 12 Almira [Nelson
 Kurzrock John, tailor, 54 West Main, h. 90
 Kurzrock John H. tailor, boards 90 Meigs
 Kuschel August, laborer, house 41 Joiner
 Kusse Abraham, carpenter, h. 5 Goodman
 Kusse John, carpenter, house Henrietta av. near Allmeroth [boards 3 Tappan
 Kussmaul Jacob, shoemaker, 78 North av.
 Kusterer Benjamin, butcher, h. 98 North av.
 Kusterer, see Koesterer
 Kutcher Sophie, widow, house 56 Hoeltzer
 Kuttruff Albert, tool forger, house 1 Green
 Kuttruff Charles, deceased July, 1875
 Kuttruff Jennie, paperworker, Paper Mills, boards Staub alley n. McCracken
 Kuttruff Pierce (*O'Connor & Kuttruff*), 55 Monroe av. b. 75 Manhattan
 Kuttruff Sarah, widow, house 8 Cobb
 Kuttruff Stephen, saloon, 21 S. St. Paul, h. do.
 Kyle Charles W. news agent, Centre c. Mill, b. 31 Court
 LA BARGE JOHN JR. cartman, h. 28 Vienna
 Labegan Benedict, watchman, 92 Allen, h. 38 Whitney
 Labegan George, polisher, bds. 38 Whitney
 Lace Robert W. printer, 1 Aqueduct, boards 8 Marietta
 Lacey Eunice M. widow, house 3 King
 Lacey William, brakeman, Erie Railway, b. Clinton Hotel
 La Court Paul, shoemaker, boards 24 Spring
 La Croix Angelina, widow, house 131 Mt. Hope avenue [Mt. Hope av.
 La Croix Caroline C. Miss, boards 131
 La Croix Joseph, millwright, boards 131 Mt. Hope avenue
 Lacy Frederick D. clerk, 44 State, house do.
 Lacy Jackson W. clergyman, h. 66 Tremont
 Ladd Francis, farmer, b. Childs n. W. Maple
 Ladday Thomas, coachman, 39 S. Clinton, house 57 Lancaster
 Laden Andrew, laborer, house 23 Gregory
 Laden Luke H. clerk, boards 23 Gregory
 Ladendorff Fred. blacksmith, 54 Fitzhugh, house 7 Catharine [Catharine
 Ladendorff Fred'k jr. clerk, 264 State, bds. 7
 Ladue Oliver, house 34 Glasgow
 Ladue Oliver L. bookkeeper, b. 34 Glasgow
 La Duque Adolphus T. painter, b. 87 South av.
 La Duque Edward P. janitor, house 23 Sibley's block [block
 La Duque Frank, blacksmith, b. 23 Sibley's
 Ladwig Christian, file manuf. foot Furnace, house 2 Nassau
 Ladwig Frederica, house 15 Webster

Ladwig John, shoemaker, 91 N. Water, h. 40 Henry
 Ladwig Rieke, widow, house 33 Sellinger
 Laen Daniel, laborer, house 54 Union alley
 Laemlein Mathias, sausagemaker, h. Clifford near Hudson
 Lafferty James H. clerk, boards 5 Hunter
 Lafferty John, teamster, boards 12 Seward
 Lafferty Patrick, removed from city
 Laffin Julia, milliner, boards 136 S. St. Paul
 Laffin Thomas, mason, house 20 Cameron
 Laffin Thomas, clerk, 260 State, boards do.
 La Fontaine Lewis G. blacksmith, Chatham corner Franklin, boards 8 Franklin
 Laforce John, mason, house 307 N. Clinton
 Laforce John A. mason, house 305 N. Clinton
 Laforce John A. 2d, clerk, 307 N. Clinton, b. do.
 Laforce Nicholas, shoemaker, 92 State, house Flower near N. Clinton
 Laforce Valentine, grocer, 307 N. Clinton, house do. [house 30 Mumford
 Lafortune Richard, shoemaker, 83 N. Water,
 La Fountain Charles H. flaglayer, h. Frances near Brown
 Laging Louisa Mrs. boards 16 Helena
 Laging Henry, carpenter, house 16 Helena
 Laging Jacob F. carpenter, boards 16 Helena
 Lagrove A. P. boards Chapman House
 Lahr Paul, slater, house Almira n. Lowell
 Laich Christian, machinist, h. 135 St. Joseph
 Laich Jacob, laborer, boards 24 Wilson
 Laich Louisa Mrs. millinery, 135 St. Joseph house do. [Prospect, house do.
 Laidlaw Mary A. Mrs. intelligence office, 1
 Laidlaw Philomelia Miss, b. 39 Plymouth av.
 Laidlaw Robert, printer, 23 West Main, h. 1 Prospect
 Laighy Mary, widow, h. r. 25 Monroe avenue
 Laighy Thos. bds. Monroe av. c. Lancaster
 Laile Ferdinand, removed to Newark, N. J.
 Laile Lena, domestic, boards 123 East av.
 Laing Edward, removed to Honeoye Falls
 Laing Emily E. Mrs. deceased Sept. 1875
 Laing James V. machinist, Brown c. Jones, house 28 Warehouse
 Laing Thomas T. carriage trimmer, 3 Canal, boards 83 Plymouth avenue
 Laird James, hairdresser, 1 Corinthian Hall, boards 9 Charlotte [Charlotte
 Laird William (*Laird & Berger*), house 9
 Laird & Berger (*Wm. Laird and P. Berger*), hairdressers, 1 Corinthian Hall
 Lais August F. optician, 179 N. St. Paul, h. 23 Nassau [boards 23 Nassau
 Lais Minnie, spectacle maker, 179 N. St. Paul,
 Lais, see Leys
 Lake Eben, engineer, house 3 Woodworth
 Lake Egbert, peddler, house 444 Brown
 Lake Eugene A. blacksmith, b. 200 W. Main
 Lake Eva L. house 30 Spring
 Lake Frederick, printer, house 10 Ward
 Lake Henry W. blacksmith, h. 200 W. Main
 Lake Stephen, painter, bds. 94 North Clinton
 Lakeman Wm. H. physician, 8 Smith, h. do.
 Laley Jacob, turner, 7 North Water, boards Mansion n. Plymouth avenue
 Lalor William, chemist, 205 Plymouth av. house Hanford's Landing

Lamb C. Lewis (*Thompson & Lamb*), 289 State, house 1 Jay [University avenue
 Lamb Frederick, gardener, h. Carleton near
 Lamb Geo. W. steam clotheswasher, house 38 Kent
 Lamb Olive, widow, boards 1 Jay
 Lamb Walter W. clerk, 18 E. Main, boards 52 North avenue
 Lamb William J. deceased May, 1876
 Lambert Andrew, mason, boards 200 Scio
 Lambert Catharine, dressmaker, boards 43 Cypress
 Lambert Henry, laborer, house 43 Cypress
 Lambert Henry H. house 154 Alexander
 Lambert James, mason, bds. 68 Oak
 Lambert James G. mason, house 68 Oak
 Lambert John, mason, house 200 Scio
 Lambert John H. salesman, 53 East Main, b. 43 Cypress
 Lambert Wilson, boards 154 Alexander
 Lamberton Alexander B. real estate, 37 Powers' bldgs. house 64 Platt
 Lambier Francis, laborer, h. Cliff opp. White
 Lamey Andrew, coal deliverer, b. 6 Garden
 Lamey John, laborer, Brown's race n. Furnace, boards 205 State
 Lamont Ann, widow, house 124 Tremont
 Lamont Bros. (*J. and J. Lamont jr.*), razor strop manuf. 35 State
 Lamont James (*Lamont Bros.*), b. 124 Tremont
 Lamont John jr. (*Lamont Bros.*), boards 124 Tremont
 Lamont Johnston, carpenter, b. 124 Tremont
 Lamoree Charles, removed to Oswego
 Lamoureux Charles, boot crimper, 40 Front, house 82 Kelly [h. 10 St. Clair
 Lamoureux Charles C. coachmaker, 3 Canal
 Lamoureux Eliza Mrs. house 218 West Main
 Lamoureux William S. carpenter, Aqueduct, house 135 Tremont [Union
 Lampanius Emma, dressmaker, bds. 24 N.
 Lampert Bernhard, grocer, Frost av. c. Reynolds, house do. [Reynolds, b. do.
 Lampert Bernhard jr. clerk, Frost av. corner
LAMPERT HENRY, tanner, Lampert's block, 81 N. Water, h. 36 N. St. Paul.—
See page 667
 Lampert Justus, shoemaker, 4 West av. h. 143 West Maple
 Lampert John, baker, boards 143 W. Maple
 Lamphier Mary, widow, boards 25 Munger
 Lamphier Minor, laborer, boards 18 Allen
 Lampman Edward L. ass't. depot master, Centre cor. Mill, house 57 Charlotte
 Lampman Geo. W. baggageman, h. 51 Strong
 Lampman Lyman O. baker, 113 East Main, house 36 South [b. 13½ East av.
 Lamport Albert G. gunsmith, 3 West Main,
 Lamson George, laborer, h. Rapids road n. city line [132 Meigs
 Lamson George J. moulder, 10 S. Water, h.
 Lamson Nellie, widow, bds. Rapids road n. city line [h. 307 do.
 Lancashire John, pyrotechnist, 305 E. Main,
 Landbeck Catharine Mrs. millinery, 41½ N. Clinton, house do.
 Landers Alfred, stonecutter, 22 West av. b. North York n. Railroad alley

Landers John J. pastor, St. John's chapel, h. 2 Fulton avenue [b. 34 N. Washington
 Landon Charles M. correspondent, 93 State,
 Landsberg Max, pastor, B'rith Kodesh congregation, house 30 Chatham
 Lane Alfred S. (*C. F. Paine & Co.*), 20 West Main, h. 56 Sophia [blk. b. 114 W. Main
 Lane Allen L. intelligence office, 6 Masonic
 Lane Ambrose N. deputy marshal, 27 State, bds. 6 East Main n. Stillson
 Lane Benjamin, bartender, Ayers Hotel, b. do.
 Lane George A. carriage maker, 16 Market, house 26 Bloss
 Lane George H. local editor, Union and Advertiser, 82 W. Main, b. 13 S. Clinton
 Lane Harriet S. widow, house 6 East Main
 Lane James, mason, boards 17 University av.
 Lane Johanna, widow, boards 101 W. Maple
 Lane Joshua H. carpenter, bds. 31 Reynolds
 Lane Katie J. music teacher, b. 134 E. Main
 Lane Mary Miss, dressmaker, 134 East Main, house do. [49 Myrtle
 Lane Morgan, laborer, Platt n. Jones, house
 Lane Patrick, helper, house 47 Myrtle
 Lane Patrick J. machinist, 138 Mill, house 101 West Maple
 Lane Sarah J. widow, boards 29 Stone
 Lane William, laborer, house 71 Atkinson
 Laney Enos G. clerk, 144 E. Main, house 7 Lancaster
LANEY JAMES, tinware and kitchen furnishing goods, 144 East Main, house 36 Clinton place.—*See page 670*
 Lang Adam, tailor, house 5 Charlotte
 Lang Annie, domestic, boards 57 Charlotte
 Lang Bernarda Sister, superior, St. Boniface's school, bds. 3 Grand
 Lang Carl, flour and feed, 59 St. Joseph, h. do.
 Lang David, cooper, house 14 Galusha
 Lang George J. (*Burger & Lang*), 4 Mt. Hope avenue, house 22 Hamilton place
 Lang Herman, polisher, house 256 N. Clinton
 Lang John M. mason, house 49 Baden
 Lang Michael, blacksmith, 35 S. St. Paul, h. 30 Wilder [259 N. Clinton
 Lang Valentine, shoemaker, 114 W. Main, h.
 Lang, see Laing [Greece
 Langdale George, machinist, 123 Mill, h. at
 Langdon Edwin M. salesman, 7 West Main, and (*E. M. Langdon & Son*), house 85 South avenue
 Langdon E. M. & Son (*J. E. Langdon*), paints, oils, 85 South avenue
 Langdon James E. (*E. M. Langdon & Son*), boards 85 South avenue [Pinnacle av.
 Langenberger Ambrose, laborer, boards 206
 Langenberger John, laborer, house 206 Pinnacle avenue [Pinnacle av.
 Langenberger John jr. laborer, bds. 206 Pinnacle avenue Lorenz, mason, boards 206 Pinnacle avenue [c. Adams
 Langenberger Richard, baker, bds. Reynolds
 Langham Benjamin, laborer, boards Saratoga avenue near Bloss
 Langham John, house 255 St. Joseph
 Langham William, mason, house Saratoga avenue near Bloss [29 Asylum
 Langie Anthony, carpenter, r. 23 Asylum, h.

Langie Eugene, removed to New York
 Langie Francis J. carpenter, b. 29 Asylum
LANGIE LOUIS C. coal dealer, 56 Hud-
 son and 154 E. Main, bds. 29 Asylum.—
See page 599 [b. 122 Front
 Langknecht Anthony, tailor, 14 Mumford,
 Langknecht George, carpenter, boards 297
 North Clinton [33 Lowell
 Langknecht Henry, bootmaker, 92 State, h.
 Langknecht Herman, market, 243 N. Clin-
 ton, house do. [house do.
 Langknecht Jacob, market, 213 N. Clinton,
 Langknecht Jacob, butcher, 297 N. Clinton,
 house do. [house do.
 Langknecht Michael, market, 297 N. Clinton,
 Langknecht Nicholas, cutter, 64 Mill, h. 5
 Buchan park [n. Allmeroth
 Langlois Conrad, laborer, h. Henrietta av.
 Langlois Henry C. removed to Lyons
 Langlois James M. boilerwasher, Brown cor.
 Jones, house 42 Thompson
 Langlois Philip, painter, h. 32 Saratoga av.
 Langlois Thomas, removed to Hamilton, Ont.
 Langmeyer Frank J. carpenter, 97 Exchange,
 house 7 Cayuga place
 Langmeyer Gregory, compositor, 3 W. Main,
 house 117 Pinnacle avenue
 Langschwager John F. C. laborer, house
 Wadsworth near Hudson
 Langschwager Sophia, widow, house Wads-
 worth near Hudson
 Langslow Henry A. bookkeeper, 88 State,
 house 50 Concord avenue
 Langslow Henry R. b. 50 Concord avenue
 Langslow Louis, shoemaker, 73 N. Water,
 boards 50 Concord avenue
 Langslow Stratton C. driver, 88 State, b. 44
 Concord avenue [St. Paul
 Langstaff Joseph K. salesman, b. 39 North
 Langtry Robert, laborer, house 60 Manhattan
 Langworthy Althea, deceased August 8, 1875
 Langworthy Charles B. clerk, b. 32 Bolivar
 Langworthy A. Elizabeth, Miss, house 70 Jay
 Langworthy Elizabeth, widow, house Kent
 corner Smith
 Langworthy Harvey P. 17 Powers' buildings'
 house 2 Arnold park [house do.
 Langworthy Henry H. physician, 79 State,
 Langworthy Henry N. house 7 Clarissa
 Langworthy Lyman B. jr. shoe cutter, 15
 Mill, house 9 Genesee
 Langworthy Lyman B. house 29 Elizabeth
 Langworthy Mary A. widow, h. 32 Bolivar
 Langworthy Stillman B. shoe cutter, 15 Mill,
 boards Smith corner Kent
 Lanksbury William P. boiler maker, 138
 Mill, h. Denning n. Broadway
 Lannis John, laborer, house 30 Catharine
 Lansing Bernard, laborer, paper mill, house
 18 Thomas [281 St. Joseph
 Lansing Herman, engineer, paper mill, house
 Lansing John, laborer, house 107 Childs
 Lansing Richard H. lawyer, 31 State, boards
 6 Centre park
 Lansing William R. bookkeeper, Traders'
 National Bank, 35 W. Main, h. 29 Greig
 Lansing William V. K. bookkeeper, house 2
 South

Lanxon Ella K. clerk, 73 E. Main, b. 7
 Waverley place
 Lanxon Johanna, widow, h. 7 Waverley place
 Lanxon Richard, deceased August 1875.
 La Point Moses, laborer, 113 W. Main, h. 80
 Hunter
 Lara Joseph, carpenter, boards 25 Favor
 Laragy Elizabeth, domestic, b. 87 Lake av.
 Laragy James, laborer, h. Lyell cor. Myrtle
 Laragy John, laborer, b. Lyell cor. Myrtle
 Laragy John jr. hairdresser, 58 Lyell, b. Lyell
 corner Myrtle
 Laragy Patrick A. stove cutter, h. 91½ Frank
 Laragy William, laborer, b. Myrtle c. Lyell
 Large Leah Miss, house 109 Champlain
 Large Mary Mrs. boards 242 East Main
 Large Mary Miss, boards 109 Champlain
 Large William, baker, 147 E. Main, h. 242 do.
 Large William J. removed to Kenosha, Wis.
 Lark Jacob, boards Anne near Otis
 Lark Jacob jr. farmer, h. Villa pl. n. Gates av.
 Lark Louisa, widow, h. Anne near Otis
 Lark Samuel, deceased July 21, 1875
 Larkin Anna, domestic, b. East av. corner
 Alexander
 Larkin Michael, laborer, house 46 Ontario
 Larkin Winfried, widow, house 13 Marietta
 Larouche Cecelia, widow, h. 40 St. Joseph
 Larouche Joseph, brakeman, b. 40 St. Joseph
 Larouhway Mary, widow, house 39 South
 Washington
 Larrabee Catharine, widow, h. 214 Alexander
 Larson Elias T. boards 19 Atkinson
 Larson George M. painter, b. 19 Atkinson
 Larson Georgiana H. dressmaker, 19 Atkin-
 son, boards do.
 Larson Martha G. widow, h. 19 Atkinson
 La Salle B. Frank, dentist, 126 Powers'
 buildings, h. 23 Jones av. [21 Smith
 Lashander Nicholas J. plasterer, 16 Stone, h.
 Lathrop Amelia M. widow, h. 20 Savannah
 Lathrop Clara C. teacher, Madison park
 School, No. 2, boards 38 Jones
 Lathrop Edward F. clerk, Erie rail'w'y freight
 office, house 4 Cypress
 Lathrop Erwin J. laborer, Erie rail'w'y freight
 house, house 44 South avenue
 Lathrop George M. policeman, City Hall, h.
 87 Tappan [house 64 Jones
 Lathrop George W. tobacconist, 148 State,
 Lathrop James M. removed to Chicago, Ill.
 Lathrop J. Alden, expressman, 35 Exchange,
 boards 68 S. St. Paul
 Lathrop Nellie C. teacher, Central School,
 No. 5, boards 38 Jones
 Lathrop William E. house 38 Jones
 La Trace George, bds. 5 Almira [5 Almira
 La Trace James L. salesman, 110 Front, h.
 Lather James, painter, 14 Stone
 Lattimore Samuel A. professor, University
 of Rochester, h. E. Main c. Gibbs
 Lattin Jacob, laborer, house St. Joseph near
 Langham [c. Bloomingdale av.
 Latz Charles, scalemaker, house N. Clinton
 Latz George, mason, h. N. Clinton corner
 Bloomingdale avenue
 Latz Henry, carriage trimmer, b. N. Clinton
 corner Bloomingdale avenue

- Latz Peter, boards 54 S. St. Paul
 Latz William H. sashmaker, Fiske's bldgs. house 61 Magne
 Latz William P. sash manuf. ft. Furnace, h. 44 Clinton place [Frances
 Laubli Mary E. widow, house Magnolia near
 Lauckard Louis, laborer, house 93 Meigs
 Laudenbach Bernhard Mrs. house 11 Pitt
 Laudenbach William, removed from city
 Laudwick Christina, widow, house 35 Cole
 Lauer Charles J. carpenter, 100 S. St. Paul, boards 87 Scio [169 St. Joseph
 Lauer Edward C. clerk, 35 Powers' bldgs. b.
LAUER FREDERICK C. & SON (F. C. Lauer, jr.), lime manufs. and contractors, 35 Powers' bldgs. h. 169 St. Joseph. —See page 581
 Lauer Frederick C. jr. (F. C. Lauer & Son), h. St. Joseph corner Hoeltzer
 Lauer Jacob M. mason, 82 Court, h. do.
 Lauer John C. jr. tucker, house 21 Wilson
 Lauer Joseph, carpenter, boards 49 Campbell
 Lauer Joseph, clerk, house 45 Campbell
 Lauer Joseph, brewer, h. Galusha c. Oakman
 Lauer J. Christian, house 19 Grove
 Lauer Louis, removed to New York City
 Lauer Mary Mrs. dressmaker, 185 Alexander, house do.
 Lauer Matthew, watchman, 53 E. Main, h. 185 Alexander
 Lauer Michael, tight cooper, house 56 Lowell
 Lauer Nicholas, German teacher, Public Schools, boards 6 Grand
 Lauer Peter, carpenter, h. Union n. Jennings
 Lauer Peter, drover, house 6 Grand
 Lauer Peter jr. detective, City Hall, house 19 Linden
 Lauer Susan, widow, house 87 Scio
 Lauer William J. carpenter, boards 87 Scio
 Laufer Christian, carpenter, house Lincoln near city line [84 Kelly
 Laufer George, pianomaker, 4 Hill, boards
 Laufer Jacob, foreman, 4 Hill, h. 84 Kelly
 Laufer Martin, varnisher, house 55 Baden
 Laughlin James, carpenter, house Champlain near Genesee
 Laughney John, expressman, 83 State, house 85 Hickory
 Launsberry Fred. car driver, bds, 26 Centre
 Laurenzis Dietrich, ass't. priest, St. Patrick's Cathedral, h. 42 Frank [h. do.
 Laurer Joseph, brewer, 139 N. St. Paul,
 Lauster Mcne, laundress, house 44 Gorham
 Lauter Felix, shoemaker, house North Clinton near Vernon park
 Lauter Joseph, shoemaker, 92 State, house North Clinton corner Avenue A
 Lauterbach Henry, teamster, h. 25 Holland
 Lauterbach Henry G. finisher, 73 State, bds. at Irondequoit [Water
 Lauterbach John, file cutter, River cor. N.
 Lauterbach John P. cabinetmaker, Mill near Brown, boards 25 Holland
 Lauth John, moulder, Brown's race near Furnace, house 13 Buchan park
 Lauzon Emma J. widow, boards 50 Lowell
 Lava Kate A. seamstress, boards 7 Bolivar
 Lavelle Alfred, driver, boards 18 Market
 Lavenguth Emiel, jeweler, 14 State, house 69
 Martin [St. Joseph n. Norton
 Lavenguth George, cabinet maker, 2 Hill, h.
 Lavenguth George jr. cabinet maker, 2 Hill, boards St. Joseph near Norton
 Lavenguth Louis, bookkeeper, boards St. Joseph near Norton
 Laverty George, clerk, 141 East Main
 Laverty James, die manuf. 129 North Water, house 41 Martin [York House
 Laverty James P. grinder, Platt cor. Mill, b.
 Lavery Frederick, brakeman, N. Y. C. R. R. boards 31 Hill
 Lavery James, laborer, h. 31 Hill [h. 16 Stone
 Lavery Terence F. printer, 82 West Main,
 Lavey Rose, domestic, boards 8 Mathews
 Lavey Theresa, domestic, boards 5 William
 Lavigne Alfred, tobacconist, 61½ Lyell, bds. Saratoga avenue corner Montrose
 Lavigne Clarinda, seamstress, bds. Saratoga avenue corner Montrose
 Lavigne Edward, cooper, 1 St. James park, boards 14 Saratoga avenue
 Lavigne Josephine, seamstress, boards Saratoga avenue corner Montrose
 Lavigne Sarah J. seamstress, boards Saratoga av. c. Montrose [c. Montrose, h. do.
 Lavigne Zebulon, grocer, Saratoga avenue
 Lavine Bernard, peddler, house 36 Joiner
 Lavis Charles (Lavis & Yates), house 7 Julia
 Lavis Lucretia, widow, boards 30 Lancaster
 Lavis Robert, nurseryman, house 34 Caroline
 Lavis Thomas, laborer, house 6 Galusha
 Lavis William, painter, house 6 East park
 Lavis & Yates (C. Lavis and C. Yates), masons, 7 Julia
 Lavulets Alfred, painter, house 7 Stone
 Lawler Eliza, laundress, bds. 9 Brown's alley
 Lawler James, tailor, 31 Stone, house do.
 Lawler John H. machinist, boards 154 Jay
 Lawler Maggie Miss, dressmaker, boards 9 Brown's alley
 Lawler Patrick H. machinist, house 154 Jay
 Lawler Patrick W. student, 83 Powers' bldgs. boards 62 Exchange
 Lawless Anna, gilder, boards 1 Sheridan pk.
 Lawless Edward, laborer, house 38 Ontario
 Lawless John, laborer, house 19 Lancaster
 Lawless John, teamster, boards 38 Ontario
 Lawless Mary, dressmaker, 129 East Main, boards 38 Ontario
 Lawless Sarah, dressmaker, h. 54 Reynolds
 Lawless Thomas, watchman, 3 Canal, house 54 Reynolds
 Lawrence Aaron P. carpenter, h. 69 Baden
 Lawrence Charles, hat rack agent, boards 32 Stone [h. 12 Kent al.
 Lawrence Charles, teamster, 19 Warehouse,
 Lawrence David T. florist, Monroe avenue near Goodman, house 1 Goodman
 Lawrence Eleanor, widow, boards 21 Elm
 Lawrence Emma, widow, house 35 Howell
 Lawrence Frederick S. boarding house, 5 Howell
 Lawrence George S. carver, b. 26 Charlotte
 Lawrence Henry E. carpenter, 120 Mill, h. 19 South [house do.
 Lawrence H. E. Mrs. dressmaker, 19 South,

HENRY C. WISNER,

KEROSENE CHANDELIERS, BRACKETS, AND LAMPS--No. 33 STATE STREET.

Lawrence James, clerk, boards 268 East av.
 Lawrence John, shoemaker, 26 Charlotte,
 house do. [South
 Lawrence John H. clerk, 53 E. Main, b. 19
 Lawrence Joseph P. clerk, Lyell c. Childs,
 boards Lyell opp. Cameron
 Lawrence J. Frank, hostler, 17 Division
 Lawrence Robert, news agent, bds. 1 Pearl
 Lawrence Robert F. farmer, h. 268 East av.
 Lawrence Rolland L. printer, h. 22 Ware-
 house [lotte
 Lawrence Samuel, 21 South av. b. 26 Char-
 Lawrence Smith, house 4 Garden
 Lawrence Thomas, laborer, h. 5 Pine alley
 Lawrence Walter, boatman, house 63 Weld
 Lawrence William, laborer, h. Magne n. R.R.
 Lawrence Wm. glazier, 36 E. Main, bds. 26
 Charlotte [bds. 32 Adams
 Lawson Adaline, clerk, County Clerk's office,
 Lawson Barbara, widow, house 59 W. Maple
 Lawson George, engineer at Osburn House,
 house 4 Concord avenue
 Lawson Henry, removed from city
 Lawson John, plumber, 153 E. Main, bds. 48
 Savannah
 Lawson John, carpenter, boards 1 Summer
 Lawson Phebe J. widow, h. 35 Monroe av.
 Lawton Albert L. student, boards Lake av.
 corner McCracken
 Lawton Arthur W. boards 160 Lake avenue
 Lawton Charles F. boards 160 Lake avenue
 Lawton Hiram, water pipes, h. Lake avenue
 corner McCracken [State
 Lawton John, shoemaker, 4 Allen, bds. 205
 Lay J. L. Mrs. clerk, boards 23 Frank
 Lays Butterfield, removed to Canton
 Lays John, cooper, 30 Canal, h. 8 Kondolf
 Lays Peter, cooper, 30 Canal, h. 6 Kondolf
 Lays Peter jr. cooper, 30 Canal, h. 7 Kondolf
 Lazell Susan, widow, boards 11 Centre park
 Lazier William N. machinist, 89 N. Water,
 boards 21 William
 Leach Charlotte, widow, house 84 Broadway
 Leach Della Miss, b. 37 Ambrose [37 Ambrose
 Leach Ebenezer, salesman, 14 W. Main, h.
 Leach Hibbard E. music teacher, 125 Powers'
 bldgs. boards 37 Ambrose
 Leach John P. file grinder, bds. 55 Munger
 Leach Robert E. hairdresser, b. 55 Munger
 Leach Sarah P. widow, house 82 Pearl
 Leach William, grinder, house 39 Sanford
 Leader Frank, teamster, Frost avenue corner
 Olean, house Scottsville road at rapids
 Leader John, coachman, house 290 State
 Leader Mont, shoemaker, house 64 Asylum
 Leadley Charles T. (*Lockhart & Leuley*), h.
 7 Conkey avenue
 Leahm Bernard, carriage trimmer, 3 Canal,
 boards 57 Hudson
 Leahm Maria Mrs. widow, house 57 Hudson
 Leahm Sarah, widow, house 7 Hanover
 Leahy Amelia H. teacher, Genesee School,
 No. 4, boards Plymouth av. n. Violetta
 Leahy John, carpenter, house Plymouth av.
 near Violetta [bds. do.
 Leahy Thomas J. confectioner, 144 W. Main,
 Leak Thomas J. clergyman, Alexander st.
 M. E. church, house 91 Alexander

Leap Benjamin B. health inspector, h. 36 Oak
 Lear Clara M. Miss, teacher, Monroe School,
 No. 15, boards 13 Kent
 Lear Henry H. laborer, h. 74 Pinnacle av.
 Lear Isaac, mason, house 13 Kent
 Learned Wm. H. clerk, boards 82 West av.
 Leary Bridget T. dressmaker, b. 24 Romeyn
L EARY DANIEL, dyeing and cleansing
 establishment, Mill corner Platt, house
 20 Frank.—*See page 580*
 Leary Daniel, laborer, bds. r. 21 Monroe av.
 Leary Daniel M. clerk, Mill corner Platt,
 boards 20 Frank
 Leary Dennis (*Leary & Co.*), b. National Hotel
 Leary James, foreman, N. Y. C. R. R. car
 shop, North, house 24 Romeyn
 Leary James jr. student, boards 24 Romeyn
 Leary John, machinist, Brown's race near
 Furnace, boards 142 Jones
 Leary John J. machinist, boards 9 Penn
 Leary Julia, widow, h. Field n. Monroe av.
 Leary Julia A. stitcher, boards 24 Romeyn
 Leary Mary, principal St. Mary's Orphan
 Asylum
 Leary Michael, teamster, house 6 White
 Leary Michael, laborer, 12 White, h. 6 do.
 Leary Thomas, watchman, house 9 Penn
 Leary & Co. (*D. Leary and C. G. Hussey*),
 liquors, 92 West Main
 Leary, see O'Leary
 Leask James, removed to Hornellsville
 Leat George (*Leat & Weitzel*), h. 43 Edinburgh
L EAT & WEITZEL (*G. Leat and J. N.*
Weitzel), boots and shoes, 127 East Main.
 —*See page 593*
 Leavenworth Eli, foreman, chair factory,
 lower falls, house 129 Lake avenue
 Leavenworth Frank H. bds. 129 Lake av.
 Leavenworth Gideon, foreman, h. 139 Lake
 avenue [York House
 Leavitt Charles M. shoemaker, 15 Mill, bds.
 Leavitt James E. removed to Buffalo
 Le Beau Lewis jr. shoemaker, 111 State, h.
 48 Baden
 Leblinc George, cooper, house 24 Moore
 Le Boo Marcellus, mason, h. Tremont c. Saxe
 Le Chandler Nicholas, polisher, 38 Gorham,
 boards 27 Buchan park [opp. Orange
 Lechleiter Adam, moulder, 8 Hill, h. Childs
 Lechleitner Paul, clerk, 126 Lake av. b. do.
 Lechner Louis, machinist, house Fourth av.
 near Central park
 Leckinger George, deceased Sept. 1875
 Leckinger George M. boots and shoes, 10 S.
 St. Paul, house 4 Weld [Berlin
 Leckinger Jacob, gardener, h. Hudson opp.
 Leckinger Jacob, clerk, 10 S. St. Paul, bds.
 69 University av. [h. 10 Buchan pk.
 Leckinger J. William, clerk, 123 East Main,
 Leckinger Martin, boots and shoes, 123 East
 Main, house 211 North Clinton
 Leclare James F. salesman, 1 East park, h.
 38 Vick park
L E CLEAR ALBERT A. photographer,
 80 State, b. 142 1/2 W. Main.—*See page 523*
 Ledoux John B. salesman, 17 State, boards
 4 North Washington [202 Alexander
 Lee Alonzo, carpenter, Court st. bridge, house

A. R. PRITCHARD & LIKLY,

GLOVES, CANES, ETC., A LARGE STOCK,
 No. 78 STATE STREET.

Lee Aloysia, principal St. Patrick's Orphan Asylum [12 N. Washington
 Lee Charles M. shoemaker, 87 N. Water, b.
 Lee Charles W. freight agent, house 160 State
 Lee Charles W. teamster, State corner Platt, boards 2 Spencer [b. do.
 Lee Charles W. clerk, S. St. Paul cor. Court,
 Lee Edwin R. last maker, 123 Mill
 Lee Eli, carpenter, h. Sawyer near Genesee
LEE ELISHA S. & CO. (*S. L. Rockfellow*),
 tree pruner manufs. 19 Warehouse, house Clifton corner St. Clair.—*See page 626*
 Lee Elizabeth, widow, house 41 Glasgow
 Lee Elon, carpenter, Court st. bridge, house 202 Alexander
 Lee Emily Miss, boards 17 Chatham
 Lee Emma J. widow, house 2 Spencer
 Lee Frank, clerk, 128 Powers' bldgs. boards Culver park
LEE FRANK A. freight deliverer, 4 State, house 58 Platt.—*See page 605* [avenue
 Lee Frank C. salesman, 17 State, bds. 18 East
 Lee Frank H. student, boards 20 Gibbs
 Lee George, removed from city
 Lee George B. removed to Mechanicsville
 Lee George P. salesman, house 17 Chatham
 Lee George R. shoemaker, 75 N. Water, bds. 113½ East Main
 Lee George S. laborer, h. Sawyer n. Genesee
 Lee Harry, waiter, Osburn House
 Lee Henry L. machinist, house Culver park
 Lee James A. shoemaker, 15 Mill, house 17 Edinburgh
 Lee James B. clerk, 16 State, h. 10 Woodbury
 Lee James C. bookkeeper, 108 State, boards 41 Glasgow [Lancaster
 Lee John, coachman, 35 S. Clinton, house 57
 Lee John, clerk, 16 Exchange, boards 39 Edinburgh [Lawrence
 Lee John B. clerk, 112 East Main, house 19
 Lee John C. laborer, boards 2 Spencer
 Lee Lemuel, agent, 40 State, boards 2 Frank
 Lee Louis E. clerk, 75 State, boards 39 Troup
 Lee L. M. salesman, 10 Mill, house at Utica
 Lee Mary W. teacher, Hudson School, No. 16, boards 33 Troup
 Lee Sarah, widow, house 89 East avenue
 Lee Thomas, teamster, Whitney Mills, boards 2 Spencer [Gibbs
 Lee Uriah D. freight agent, 92 Mill, house 20
 Lee Wah & Co. (*Hong Wah and Thomas Shing*), laundry, 176 State, house do.
 Lee Walker S. propr. City Hotel, S. St. Paul corner Court
 Leedy Sarah J. widow, house 176 W. Main
 Leffingwell Mary E. house 37 Charlotte
 Leffer John, house 49 Gregory
 Leffer, see Loeffler
 Leffert Mary, widow, bds. r. 76 Mt. Hope av.
 Lefmann Louisa, tailoress, boards 71 Martin
 Lefmann Mary, widow, house 71 Martin
 Lefrois Joseph, milk dealer, h. 24 Goodman
 Le Gacy George E. shoemaker, 111 State, b. York House [boards do.
 Legenbauer Nicholas, laborer, 9 S. Clinton,
 Leggett Alfred (*H. J. Howe & Co.*), 3 Andrews, house 24 Asylum
 Leggat W. A. boards Brackett House

Leggett Andrew T. stitchee, 3 Canal, house 75 Bolivar [4 N. Ford
 Leggett George W. stone cutter, 8 West av. b.
 Leggett Joseph, farmer, house Waring road near Norton [Jennings
 Leggett Sophia, widow, house Goodman near
 Legler Adolph, laborer, house 93 Weld
 Legler George M. shoemaker. bds. 92 Weld
 Legler Joseph, policeman, City Hall, house 108 Tappan
 Legler Mary A. widow, house 92 Weld
 Legler Matthias, deceased April, 1876
 Legler Matthias, dresser, 55 S. St. Paul, bds. 92 Weld [Violetta
 Lehle Jacob, tanner, house Mansion near
 Lehman Benedict, fence maker, 188 State, h. 98 Hudson
 Lehman Herman, grocer, 126 Lyell, h. do.
 Lehman John, laborer, house 30 Sanford
 Lehman Leopold, peddler, house 29 Holland
 Lehman Roman, tailor, house 227 E. Main
 Lehmann John H. carpenter, b. 156 North Clinton [70 State, house 99 Hudson
 Lehnkering August C. L. photographer,
 Lehr Frank, butcher, 44 Front, h. Hoelfer near St. Joseph
 Lehr William, boards 103 Jay
 Lehr Martin, laborer, h. N. Clinton n. city line
 Lehrschooll Charles, tailor, Ames n. Jay, h. do.
 Leibach Catharine, widow, h. 38 Campbell
 Leibach Frances, widow, house 143 Campbell [c. West Maple, house do.
 Leibert Frederick, cigar maker, North York
 Leibfritz Frederick, mason, house 43 Kelly
 Leibig Johh, carpenter, Exchange opposite Glasgow, h. Laforce pk. n. N. Clinton
 Leidecker Elizabeth, tailoress, h. 36 Sellinger
 Leidecker Frank, asst. weighmaster, weighlock, boards 36 Sellinger
 Leidecker Frank J. grinder, h. 186 St. Joseph
 Leidecker G. Frederick, grocer, 291 North Clinton, house do.
 Leidecker John, laborer, house 199 Scio
 Leidecker Michael, cabinet maker, house 22 North York [Munger
 Leight John, painter, 16 Stone, house 41
 Leight John A. butcher, h. Lyell n. Whitney
 Leighton James Mrs. b. 44 North avenue
 Leighton Peter, agent, 73 East Main, boards 119½ do.
LEIGHTON THOMAS (*Leighton Bridge and Iron Works*), Leighton av. n. Goodman, and resident City Bank of Rochester, h. East avenue near Culver.—*See back colored page*
 Leimester George, laborer, house 91 Smith
 Leimester Magdalena Mrs. [midwife, 91 Smith, house do. [Water
 Leimgruber Max, hair dresser, boards 20 N.
 Leimgruber Victoria Mrs. saloon, 20 North Water, house do. [Franklin
 Leinen Joseph P. clerk, 37 State, boards 72
LEINEN PETER, carpet cleaner, 162 S. St. Paul, house 72 Franklin.—*See page 597*
 Leipold John, clerk, 44 Front, h. 34 Nassau
 Leipolt Margaret, widow, boards 1 Dover
 Leis Christian, tailor, house 72 Lincoln
 Leis John, polisher, house 15 Shamrock

HENRY C. WISNER,

**CUT AND PRESSED GLASS TABLE WARE,
 No. 33 STATE STREET.**

Leis Theodore, clerk, saloon W. Main cor. Exchange, house 6 Kirk
 Leis see Laiss
 Leisenring Charles A. carpenter, h. 3 Kent al.
 Leisenring Olin D. student, University of Rochester, boards 48 University avenue
 Leist Louis C. deputy collector internal rev. 7 Powers' bldgs. b. E. Main n. Stillson
 Leister Robert, boards 22 Smith
 Leiter Henry (*Shatz, Lowenthal & Leiter*), 40 State, house 69 Andrews
 Leland John F. removed to Colorado
 Leland Laura E. teacher, Andrews School, No. 9, boards 43 Franklin
 Lemen Theodore A. student, University of Rochester, b. 65 North
 Le Mesurer Harriet, laundress, Osburn House
 Lemieux Joseph, baker, 132 State, house 8 Oakman [St. Joseph
 Lemke Herman, laborer, house Langham n.
 Lemke John, laborer, h. Eighth n. Emerson
 Lemmon John, removed from city
 Lemon Samuel M. cashier, 4 West Main, b. 17 Sophia
 Lemon Wm. carder, house 138 Jay
 LeMoyné Wm. M. machinist, Brown c. Jones, house 6 North avenue
 Lempert Hermann, agent, house 76 Atwater
 Lempert Julius H. salesman, 54 Mill, boards 76 Atwater
LEMPERT LEON H. fresco artist, Roch. Opera House, h. 9 Howell.—*See page 591*
 Lempert Morris H. salesman, 49 Mill, boards, 76 Atwater
 Lempert, see Limpert [Sibley
 Lemrow James, bar tender, 49 E. Main, b. 26
 Lengeman John, tailor, house 36 Bartlett
 Lenhuse Conrad, planer, 87 Exchange, bds. Hamilton avenue
 Lenihan Geo. F. moulder, house 29 Platt
 Lenihan Jane, widow, boards 29 Platt
 Lenihan John, teamster, 54 Fitzhugh, house 41 South Washington
 Lennon Barnard, tailor, house 10½ Emmett
 Lennon James, grocer, Plymouth av. corner Bartlett, house do.
 Lennon James, gardener, h. r. 15 Gorham
 Lennon James W. moulder, b. r. 15 Gorham
 Lennon John, saw grinder, 153 State, house 12 Romeyn [No. 13, b. r. 15 Gorham
 Lennon Margaret J. teacher, Munger School,
 Lennon Robert J. clerk, 72 E. Main, boards rear 15 Gorham [house 11 Vine
 Lennox Archibald F. stereotyper, 24 Front,
LENNOX JAMES, electrolyte foundry, 24 Front, h. 132 University av.—*See page 521*
 Lent Daniel E. thermometer maker, 3 Hill, house West Troup near Wall
 Lent George W. conductor, h. 27 North av.
 Leo Daniel, painter, boards 69 Orange
 Leo Dennis, finisher, 73 State, b. 69 Orange
 Leo Mary Sister, Notre Dame, Hudson cor. Clifford
 Leo Patrick, cartman, house 69 Orange
 Leonard Anna E. widow, h. 18 Briggs' blk.
 Leonard Benjamin F. millwright, b. 182 Scio
 Leonard Bridget, widow, house 24 Terry
 Leonard Catharine Mrs. boards 67 Frank

Leonard Charles, cooper, Magne near Lyell, house 4 Costar
 Leonard Edward, painter, boards 67 Frank
 Leonard Elsie, widow, boards 85 Troup
 Leonard Eugene, clerk, 144 North av. bds. 29 Kirk
 Leonard Fanny A. stitcher, bds. 151 Frank
 Leonard Frank, laborer, b. 15½ Monroe av.
 Leonard Henry E. printer, 3 West Main, b. 27½ Kirk [15 West
 Leonard Ignatz, cooper, 1 St. James pk. h.
 Leonard Ira G. clerk, County Clerk's Office, house 118 West avenue [10½ Elm
 Leonard Isaac W. foreman, 16 State, house
 Leonard James, laborer, b. 15½ Monroe av.
 Leonard James, chairfinisher, house 67 Frank
 Leonard James M. boots and shoes, 322 State, house 56 Jones [56 Jones
 Leonard James M. jr. clerk, 322 State, bds.
 Leonard John, laborer, b. 15½ Monroe avenue
 Leonard John E. printer, 33 Exchange, bds. 71 University avenue
 Leonard John H. deceased November 12, 1875
 Leonard John W. cigar maker, 123½ East Main, boards 22 Charlotte [23 Vine
 Leonard Lottie Miss, clerk, 43 State, boards
 Leonard Mary A. stitcher, b. 151 Frank
 Leonard Mary A. widow, house 27½ Kirk
 Leonard Matthew, hatter, 2 Mumford, house 49 Smith
 Leonard Peter, saloon, 85 S. St. Paul, h. do.
 Leonard Robert, cutter, 141 N. Water, h. 6 Woodbury
 Leonard Thomas, laborer, house 35 Jones
 Leonard Thomas, laborer, boards 68 Oak
 Leonard William E, harnessmaker, house 42 Brown's alley [corner North
 Leonard William H. blacksmith, Franklin
 Leonhard Cæsar, draughtsman, h. 15 Vose
 Leonhard John, cooper, boards 16 West
 Leonhard Zacharius, cooper, house 16 West
 Leopold Henry, clerk, 16 W. Main, house 28 Catharine
 Leopold John, butcher, house 14 Nassau
 Lepine Theophile W. watchmaker, 2 State, house 83 William
 Lepine T. W. stone cutter, bds. 83 William
 Lepper Andrew J. mason, h. Myrtle n. Lyell
 Lerch Anthony, saloon, 49 N. Frances, house do. [house 51 Smith
 Le Ross Thomas N. painter, Brown c. Jones,
 Leroux Auguste, cook, Osburn House, b. do.
 Le Roy Abram, mason, h. 16 Huntington
 Le Roy Althe, widow, house Lakeview
 Le Roy Charles F. artist, bds. 146 W. Main
 Le Roy Frank, laborer, house Lake avenue near Lakeview [Allen
 Le Roy Henry, shoemaker, 81 N. Water, b.
 Leroy James, laborer, bds. Lake avenue near Lakeview
 Le Roy Peter, laborer, boards Lakeview
 Leschander Jacob, machinist, b. 27 Buchan park
 Leschander Michael, laborer, boards 167 Jay
 Leschander Nicholas, house 27 Buchan park
 Leschander Nicholas M. polisher, boards 27 Buchan park
 Leschander Peter, cooper, house 167 Jay

Leschander Peter, laborer, b. 27 Buchan pk.
 Leschander, see Lashander
 Leseritz Louisa Mrs. house 5 Hanover
 Leseritz Frank S. (*Jettles & Leseritz*), 107 Powers' buildings, house 5 Hanover
 Leslie George A. clerk, 164 State, h. 66 Lyell
LESLIE W. M. H. ticket agent, 164 State, house 31 Ambrose. — *See Railroads in Contents*
 Leslie, see Lesslie [house 31 Rhine
 Lessean Charles H. J. helper, 121 N. Water,
 Lesser Herman, tailor, house 5 Pryor
 Lesser Herman, peddler, house 57 Herman
 Lesser Rachel, widow, house 57 Herman
 Lessie Frances, clerk, 20 East Main, b. 8 do.
 Lesslie James P. clerk, boards 34 North av.
 Lesslie Phebe E. widow, house 34 North av.
 Lessord Joseph, shoemaker, 124 Front, house 4 Henry
 Lester Chas. H. student, University of Rochester, boards 10 George
 Lester Chas. J. machinist, boards 22 Smith
 Lester Emma A. Miss, boards 34½ Jones
 Lester George E. student, 43 Powers' bldgs, boards 22 Smith [10 Caledonia av.
 Lester Henry, stoves, 174 West Main, house
 Lester James (*Lester & Gillard*), h. 22 Smith
 Lester Michael, deceased May 28, 1875
 Lester Robert J. clerk, 10 Exchange, h. Plymouth avenue near Flint [house do.
 Lester William R. artist, 192 Powers' bldgs.
 Lester —, rectifier, boards 170½ West Main
LESTER & GILLARD (*J. Lester and C. P. Gillard*), pattern makers, Shawmut bldg. Mill near Factory. — *See page 675*
 Letgus Margaret, waiting woman, N. Y. C. depot, boards 2 Herman [Evergreen
 Lettau Carl, printer, 149 N. Water, boards 3
 Lettau Christoph, tanner, h. 3 Evergreen
 Lettau Gustave, market, 30 Hanover, h. do.
 Lettau Joseph C. musician, h. 21 Cayuga pl.
 Letterer Christopher, box maker, ft. Centre, house 3 Evergreen
 Lettgus Marcella, widow, boards 27 Bond
 Lettington Geo. W. clerk, b. 25 Exchange pl.
LETTINGTON HORACE, paper box maker, 25 Exchange place, house do. — *See page 645* [Exchange pl. h. 114 W. Main
 Lettington John W. (*Lettington & Wimble*), 25
 Lettington & Wimble (*J. W. Lettington and J. S. Wimble*), lunch rooms, 25 Exchange place
 Leusch Charles, laborer, house 28 Weeger
 Levet Mary A. boards 11 Madison
 Levet William B. (*Buell & Levet*), 22 Exchange, house 17 New York
 Levi Abraham, peddler, house 7 Herman
 Levi Adam, clerk, 36 W. Main, b. 48 Joiner
 Levi Asahel, peddler, house 23 Catharine
 Levi Bernard, peddler, boards 25 Joiner
 Levi Harris, peddler, house 39 Hanover
 Levi Henrietta, widow, house 48 Joiner
 Levi Henry, produce, house 39 Chatham
 Levi Joseph, peddler, house 40 Joiner
 Levi Joseph, bookkeeper, b. 36 N. Clinton
 Levi Nathan & Co. (*R. Lichtenstein, W. C. Lewis and B. Rothschild*), clothing, 25 Mill, house 36 North Clinton

Levi Rachel, widow, house 4 Hamburg
 Levi Simon, peddler, house 25 Joiner
 Levi Soloman, clerk, 36 West Main, boards Chapman House
 Levi Solomon, clerk, boards 39 N. Chatham
 Levi, see Levy [h. 28 Lancaster
 Levielle Charles, shoemaker, 127 S. St. Paul,
 Levile Harriet, sewer, h. 227 East Main
 Levis Catharine, widow, boards 118 Tremont
 Levis Diana, widow, house 87 Atkinson
 Levis Edward J. clerk, b. 107 Atkinson
 Levis George, laborer, house 118 Tremont
 Levis John, laborer, house 26 West avenue
 Levis John H. shoemaker, 81 N. Water, bds. 87 Atkinson
 Levis Joseph, bricklayer, house 60 Adams
 Levis Margaret, shoefitter, bds. 87 Atkinson
 Levis Richard, laborer, bds. 26 West avenue
 Levis Richard, cartman, house 107 Atkinson
 Levis Richard B. shoemaker, 81 N. Water, boards 87 Atkinson
 Levis Robert G. shoemaker, Andrews c. N. Water, house 70½ Reynolds
 Levis Samuel, clerk, 82 State, b. 118 Tremont
 Levis William, laborer, house 54 Litchfield
 Levison Albert, house 52 N. Clinton
 Levison Bertha, cigar manuf. 52 N. Clinton, house do.
 Levison Max, salesman, b. Brackett House
 Levison Morris M. salesman, 14 West Main, house 12 Morris [43 Rhine
 Levison Norman, salesman, 66 Mill, house
 Levison Paul, peddler, house 4 Vienna
 Levy Abraham, clerk, 46 Front, b. 67 Herman
 Levy David, peddler, house 27 Rhine
 Levy Jacob H. house 8 Oregon
 Lew Chas. H. pressman, 23 W. Main, boards 22½ East Main
 Lewalter Sophia, widow, house 1 Eagle
 Lewalter William A. tinsmith, 16 S. St. Paul, boards 1 Eagle
 Lewerenz Christian, laborer, h. 2 Zimmer
 Lewerenz Frederick T. laborer, house 21 Hoeltzer
 Lewerenz John, laborer, house 37 Hoeltzer
 Lewerenz Joseph, removed from city
 Lewis Aaron C. waiter, house 176 State
 Lewis Abraham, peddler, bds. 4 Hamburg
 Lewis Almira Mrs. nurse, Children's Home, 263 N. St. Paul [r. 57 W. Maple
 Lewis Arlington, carrier, 130 Front, house
 Lewis Alice Mrs. dressmaker, bds. 2 Frank
 Lewis Benj. G. canal inspector, 40 Smith's block, house 4 Hunter [green
 Lewis Charles D. expressman, h. 17 Ever-
 Lewis Charles J. foreman, house 75 S. Ford
 Lewis Clarence E. porter, house 38 Gibbs
 Lewis D. Allen, salesman, 53 East Main, h. 83 North avenue [Munger
 Lewis Edward T. clerk, 84 East Main, h. 7½
 Lewis Erastus D. driver, 6 Front, boards 38 North St. Paul
 Lewis Fred. deceased September, 1875
 Lewis Fred. H. optician, house 18 Asylum
 Lewis Fred. H. jr. clerk, 1 East park, boards 18 Asylum
 Lewis George, carpenter, h. 310 E. Main
 Lewis Geo. E. carpenter, h. 13 Conkey av.

HENRY C. WISNER,

DECORATED CHINA, SILVER SETS,
 No. 33 STATE STREET,

Lewis George E. jr. (*Lewis & Parker*), house 13 Conkey av. [man
 Lewis George Howard, b. East av. c. Good-
 Lewis George W. boards 39 Asylum
 Lewis Henry H. house 37 Pearl [Reynolds
 Lewis James, laborer, house Tremont near
 Lewis James W. harnessmaker, 72 Monroe
 avenue, bds. 35 Broadway
 Lewis Julia F. bds. East Main near Stillson
 Lewis Lydia, widow, house 43 Scio
 Lewis Mary, widow, h. 41 Brown's block
 Lewis Richard D. farmer, h. Bay n. Hebard
 Lewis Robert S. agent, 95 Waverley block, h.
 30½ Meigs
 Lewis Sarah, domestic, 18 Allen
 Lewis Sophia, forewoman, boards 7 Jay
 Lewis Sylvester, salt manufacturer, house 9
 North Frances [N. Frances
 Lewis S. Francis, salt manufacturer bds. 9
 Lewis Tryphena, widow, bds. 35 Broadway
 Lewis Walter C. (*N. Levi & Co.*), 25 Mill, h.
 202 E. Main near Gibbs
 Lewis Wesley Z. upholsterer, 205 East Main,
 house 45 University avenue
 Lewis Wm. A. clerk, 136 State, boards 22
 Arnold park
 Lewis William H. switchman, Jay st. cross-
 ing, h. 13 Martin
 Lewis William N. machinist, h. 32 Jones
 Lewis & Parker (*G. E. Lewis, jr. and I. W.
 Parker*), cabinetwork, 153 W. Main
 Lewis, see Luis
 Ley Christian, house 3 Buchan park
 Leyden Edward C. agent, 93 State, boards 1
 Reynolds [house 1 Reynolds
 Leyden Maurice (*Davis & Leyden*), 93 State,
 Leys Charles, showcase maker, h. 10 Hun-
 tington
 L'Hommedieu Nelson, superintendent, 14 W.
 Main, house 8 Fulton avenue
 Licht Fritz A. student, Rochester Theological
 Seminary, boards 118 Alexander
 Lichtenstein Rudolph (*N. Levi & Co.*), 25 Mill,
 house 21 Clinton place
 Lichtwart Christian, tanner, house 332 N.
 Clinton [Clinton
 Lichtwart Christian jr. tanner, boards 332 N.
 Lichtwart John, sashmaker, b. 332 N. Clinton
 Lick Elizabeth, widow, house 295 Brown
 Lick Jacob J. upholsterer, 9 Front
 Lick Peter, laborer, Exchange opp. Troup,
 house 44 Campbell
 Liddell John B. machinist, b. 45 Ambrose
 Liddell Walter, engineer, N. Y. C. R. R.
 shop, h. 45 Ambrose [b. 45 Ambrose
 Liddell Walter jr. machinist, Brown c. Jones,
 Liddell William T. machinist, Brown cor.
 Jones, boards 45 Ambrose
 Liddle Robert (*Sibley, Lindsay & Curr*), 73
 E. Main, bds. Whitcomb House
 Lidster Laurino T. plumber, b. 30 Lake av.
 Lieberman Wm. tailor, house 2 Concord av.
 Liepline George, cooper, 1 St. James park,
 house 24 Moore [Meigs
 Liese George, teamster, boards Caroline near
 Liese George, cabinetmaker, Jay cor. Erie
 canal, house 30 Cayuga place
 Liese Henry, laborer, house Caroline n. Meigs

Liese John, musician, h. Henrietta av. near
 Pinnacle avenue [b. 29 Thomas
 Liesegang Frank, shoemaker, 20 Catharine,
 Liesegang Frederica, widow, h. 29 Thomas
 Lietzenmayer William, clerk, 3 Hunter, h.
 47 Cady
 Lieve James, plasterer, house 23 Moore
 Lifeber Abraham, wagonmaker, 146 Ply-
 mouth avenue, h. rear 32 Tremont
 Lifeber Abraham P. painter, boards rear 32
 Tremont [15 Bay
 Light John, trunkmaker, foot Rowe, house
 Light John, actor, Rochester Opera House
 Light, see Leight
 Lightfoot John, shoemaker, 81 N. Water, h.
 70 North avenue
 Lightfoot Sophia, sewer, 87 N. Water
 Lighthill Carl B. physician, 14 Leopold,
 house do. [h. 148 Pinnacle av.
 Lighthouse Adam, collarmaker, 129 State,
 Lighthouse Charles F. bookkeeper, 129 State,
 boards 154 Pinnacle avenue
 Lighthouse David, cutter, 129 State, h. 140
 Pinnacle avenue [h. 49 Sophia
 Lighthouse John C. collar manuf. 129 State,
 Lighthouse John J. boatbuilder, house 154
 Pinnacle avenue [avenue
 Lighthouse Joseph, butcher, b. 154 Pinnacle
 Ligowri Sister, teacher, bds. Jay c. Frank
 Likly Henry (*A. R. Pritchard & Likly*), 78
 State, house 23 Fulton avenue
 Lill Elizabeth, tailoress, boards 2 Clifford
 Lill Jacob, tailor, boards 2 Clifford
 Lill Joseph, carpenter, 43 Rauber, house do.
 Lill Joseph, laborer, 117 N. Clinton, house
 Alphonse near Thomas
 Lill Michael, laborer, house 2 Clifford
 Lilley James, car driver, house 1½ Jay
 Limb Charles J. filecutter, boards 162 Brown
 Limb Elizabeth, widow, house 162 Brown
 Limb John A. clerk, 69 Jay, bds. 162 Brown
 Limbach Jacques, barkeeper, b. 58 N. Clinton
 Limbach Paul, varnisher, 184 State, house
 30 Kelly [162 St. Joseph
 Limpert Christian, cabinetmaker, 2 Hill, h.
 Lincoln Anna Miss, boards 7 Park avenue
 Lincoln Calvin, agent, house 107 Frances
 Lincoln Charton W. removed to Penfield
 Lincoln Clarence P. removed to Los Ange-
 los, Cal.
 Lincoln Dawson W. builder, h. 29 Gregory
 Lincoln Frank H. clerk, 112 Front, house 33
 Grape [North avenue
 Lincoln George W. stationer, house 84½
 Lincoln Henry D. carpenter, b. 29 Gregory
 Lincoln J. gardener, boards 153 Hudson
 Lincoln Sophronia Mrs. house 4 Adams
 Lindau Frederick, mason, house 32 Sanford
 Lindau Gottfried F. mason, h. 43½ Sanford
 Linden James, machinist, 116 Mill, boards 4
 Adams
 Lindenbergh John, laborer, house 74 Lincoln
 Linder Frederick, laborer, Exchange opp.
 Troup, house 386 Brown
 Lindgren Nils Peter, tailor (*Lindgren &
 Walker*), house 11 Granger
 Lindgren & Walker (*N. P. Lindgren and J.
 P. Walker*), tailors, 28½ E. Main

A. R. PRITCHARD & LIKLY,

SOLID RED CEDAR TRUNKS,
 No. 78 STATE STREET.

Lindner Emanuel, optician, h. 55 Chatham
 Lindner Hermann, clerk, 73 E. Main, boards
 55 Chatham
 Lindner Michael, cooper, h. 3½ McDonald av.
 Lindner Theodore, machinist, Brown corner
 Jones, house 22 Charlotte
 Lindsay Alexander M. (*Sibley, Lindsay &
 Curr*), 73 East Main, house 45 Park av.
 Lindsay Andrew, melter, rear 204 State, h.
 Vincent place near State
 Lindsay David, deceased Dec. 18, 1875
 Lindsay John, laborer, house 67 Wilder
 Line Catharine, widow, house 31 Magne
LINE EDWARD, sign painter, 89 Arcade,
 house 66 Clifton.—*See page 517*
 Line Edward jr. sign painter, 88 Arcade, b.
 66 Clifton
 Line Francis, clerk, 194 State, boards 31
 Magne [bds. 66 Clifton
 Line Frederick S. machinist, Court c. Stone,
 Line George H. grinder, 136 Mill, b. 55 Nassau
 Line Isaac L. expressman, 83 State, house 31
 Asylum [bds. do.
 Line Jennie, dressmaker, 153 Caledonia av.
LINE J. EDWARD, dentist, 50 Smith's
 block, h. 27 Jones av.—*See page 513*
 Line Valentine, patternmaker, b. 31 Magne
 Line William jr. shoe cutter, 73 N. Water,
 boards 31 Magne
 Lines Stephen V. & Sons (*W. H., S. V. jr.
 and E. B. Lines*), boots and shoes, 50
 State, house at Canandaigua
 Lines Stephen V. jr. (*S. V. Lines & Sons*),
 house 5 Chestnut park
 Lines William D. oil dealer, house 59 Troup
 Lines Wm. H. (*S. V. Lines & Sons*), boards
 Whitcomb House [boards do.
 Ling Laura M. Mrs. dressmaker, 23 Stillson,
 Ling Robert, machinist, house 23 Stillson
 Linge Adam, deceased Feb. 1876
 Lingel William, laborer, 22 West av. boards
 78 West Maple
 Lingg John B. shoemaker, house Huntington
 Lingham George, engineer, N. Y. C. R. R.
 house 26 Spencer
 Lingham George lastmaker, boards 71 Allen
 Lingle George, lastmaker, Shawmut building,
 boards King c. Allen
 Link Elizabeth, tailoress, house 9 Rauber
 Link Frank, boatman, h. Pinnacle av. near
 Henrietta avenue
 Link Margaret, house 9 Rauber
 Linke Andrew, peddler, boards 1 Almira
 Linke Chas. H. cigar manuf. 8 Caspar, h. do.
 Linke Christian H. carpenter, house 1 Almira
 Linke George E. picture framer, b. 1 Almira
 Linke John H. casketmaker, bds. 1 Almira
 Linley George, salesman, 66 Mill, h. 34 Jones
 Linn Andrew, safemaker, 188 State, house
 129 Jay [b. 129 Jay
 Linn Andrew jr. machinist, Mill foot Platt,
 Linn Philip, cutter, 36 Mill, house 9 Weeger
 Linscott Frederick E. bookkeeper, 21 East
 Main, boards 16 Marshall [74 Court
 Linscott Philip, tailor, 18 West Main, house
 Linsin John F. confectioner, 79 N. Clinton,
 house do.
 Lintz Barbara, widow, house Jay n. Childs

Lintz Caspar, shoemaker, h. 171 Jay n. Childs
 Lintz Frances, widow, h. Goodman n. Bay
 Lintz George, shoemaker, boards 102 Front
 Lintz John, laborer, house 192 Pinnacle av.
 Lintz John, shoemaker, Andrews c. North
 Water, house Childs near Jay
 Lintz Nicholas, laborer, house 43 N. Frances
 Lintz Thomas, shoemaker, 140 W. Main, h.
 37 Wackerman
 Linvell James H. engraver, h. 23 Prospect
 Lipe Jasper H. printer, 3 West Main, house
 2 McDonald avenue
 Lipe Joseph W. house 34 Franklin
 Lipe Phebe E. millinery, 34 Franklin, h. do.
 Lipman Isaac, peddler, house 30 Weld
 Lippert Michael, watchmaker, 150 North av.
 house do.
 Lippala Elizabeth, clerk, boards 7 John
 Lippmann Charles, butcher, 54 N. Clinton,
 h. 57 St. Joseph [Clinton
 Lipsis Seymour, salesman, 49 Mill, b. 71 N.
 Lipski Isaac, peddler, house 19 Pryor
 Lipski Jacob, clergyman, house 19 Pryor
 Lipski Juda, peddler, house 5 Herman
 Lipsky Mendel, clothing, 28 Front, house do.
 Liscom Charles H. books, 36 Smith's blk.
 bds. 51 Spring [22 Elm
 Liscom William A. printer, 67 Arcade, bds.
 Lisle Thomas, removed to Greece
 List Ferdinand, saloon, 148 Brown, b. 72 Jay
 Listmann Albert, clerk, 6 South St. Paul, b.
 107 Orchard
 Listmann Caspar. saloon, Oak n. Smith, h. do.
 Listmann Frank, cigarmaker, b. 107 Orchard
 Litster Emma, boarding house, 171½ E. Main
 Little Adelbert P. stenographer, 133 Powers'
 buildings, bds. 129 West avenue
 Little Anne, bds. East avenue, c. Alexander
 Little Charles, driver, 61 Front, b. 18 Wilder
 Little Charles W. carpenter, h. 200 Monroe
 avenue
 Little David, physician, 82 Plymouth av. h. do.
 Little Elijah H. milkman, house 68 Gregory
 Little Francis W. bookkeeper, East av. near
 Culver, house Meigs near East avenue
 Little Frank R. cartman, boards 18 Wilder
 Little Henry, carpenter, house 4½ Dover
 Little James M. cooper, Magne near railroad,
 house 39 North Frances
 Little Julia E. widow, h. East av. n. Culver
 Little Margaret, widow, house 18 Wilder
 Little Marshal E. house 129 West avenue
 Little Nancy P. Mrs. widow, house 49 Court
LITTLE WILLIAM S. Commercial Nur-
 series, East avenue near Culver, house
 do.—*See back cover*
 Littlefield Cyrus, conductor, N. Y. C. R. R.
 house 120 North Clinton
 Littley James R. mason, house 56 Thompson
 Littrick Frederick, laborer, h. Alexander n.
 Central avenue
 Litz John, house 143 Pinnacle avenue
 Liverman George, grinder, h. 20 Gregory
 Liverman Sebastian, shoemaker, house rear
 72 Mt. Hope avenue [al. n. Champion
 Livingston Alexander C. peddler, h. White
 Livingston Alonzo, agent, Fulton Towing
 Co. 4 Jackson, house at Phenix

- Livingston Edmund H. laborer, 215 State, h. 107 Fulton avenue [Clinton]
- Livingston Eliza Mrs. boarding, house 16 N.
- Livingston Janette, widow, house 20 Delevan
- Livingston Wm. baker, 74 West av. bds. do.
- Lloyd John M. painter, 153 W. Main, bds. Ayer's Hotel [bds. 10 Tyler]
- Loasby Alfred, hairdresser, 154 North av.
- Loasby Samuel, shoemaker, 160½ North av. house 1 Tyler [North avenue]
- Loasby Samuel jr. shoemaker, 4 Allen, h. 158
- Loasby Wm. fireman, boards 65 Wilder
- Loavenbruck Barbara, widow, h. 65 Wilder
- Loavenbruck Peter, coffinmaker, 22 S. St. Paul, boards 65 Wilder [Sycamore]
- Lobb Wm. blacksmith, 174 E. Main, h. 2
- Loddell James Harvey, clerk, h. 1 Lorimer
- Lochner Charles, smoother, 38 Gorham, b. 22 Nassau
- Lochner David, mason, house 95 Chatham
- Lochner Elizabeth Mrs. boards 22 Nassau
- Lochner John, mason, house 22 Nassau
- Lochner Joseph, laborer, h. Maria c. Clifford
- Lochner Joseph, tailor, house 9 Rhine
- Lochner Lewis, stonecutter, h. 47 Vienna
- Lochner Valentine, tailor, house 64 Kelly
- Lochte Henry C. J. janitor Free Academy, boards 35 Frank [toga av. h. 36 Bloss]
- Lock Oliver, carpenter, Jones av. cor. Sara-Locke Almira, stitchee, bds. 97½ East Main
- Locke Jennie R. compositor, 23 West Main, boards 10 Waverley place
- Locke John C. house 66 South Union
- Locke Kate M. boarding, 217 Exchange, house do. [State, boards 34 John]
- Lockhart Alexander C. framemaker, 121
- Lockhart Coburg W. moulder, Brown's race near Furnace, house 41 Tyler
- Lockhart Francis, house 7 Chatham
- Lockhart Henry, cabinetmaker, h. 279 N. St. Paul
- Lockhart Isabella, widow, boards 7 Chatham
- L**OCKHART JAMES, picture frame maker, 121 State, house 34 John.—See page 525
- Lockhart John, laborer, h. Union n. Jennings
- Lockhart Mary I. teacher music, b. 7 Chatham
- Lockhart Wm. fish peddler, boards 195 Scio
- Lockhart Wm. J. butcher, 26 Mumford, house do. [house 1 Linden]
- Lockhart William J. (Lockhart & Leadley), **L**OCKHART & LEADLEY (W. J. Lockhart and C. T. Leadley), wood engravers, 24 East Main.—See page 577
- Lockie Peter, limb maker, 443 Brown, h. do.
- Lockley Edward, millwright, 13 S. Water, house 19 Galusha
- Lockwood Charles H. removed to Wolcott
- Lockwood Chauncey, foreman, 4 Franklin, house 102½ East Main [Champlain]
- Lockwood Geo. carpenter, 93 State, house 16
- Lockwood Horace, removed to Webster Corners
- Lockwood May J. house 18 Scio
- Lockwood R. Margaret, widow, house 7 Johnson park
- Lockwood Willis J. painter, b. 16 Champlain
- Loder George F. clerk, post office, house 115 East avenue
- Loder Henry A. painter, 12 Stone, h. 45 Scio
- Loder Marlin, can opener maker, h. 45 Scio
- Loeb Adelia, widow, house 40 Campbell
- Loeb George, tailor, house 92 Hudson
- Loeb's Albert H. bookkeeper, 153 State, bds. 110 Hudson
- Loeb's Catharine, widow, boards 42 Herman
- L**OEBS DANIEL, flour, grain, &c. 105 Hudson and 14 Allen, house 105 Hudson.—See page 552
- Loeb's Dan'l. jr. clerk, 14 Allen, b. 105 Hudson
- Loeb's Frederick (Meyer & Loeb's), 110 Hudson, house do. [house do.]
- Loeb's Frederick C. brewer, 110 Hudson
- Loeb's Levi L. bookkeeper, 14 Allen, b. 105 Hudson
- Loeffler John, foreman, h. 15 Elizabeth pl.
- Loeffler Michael, laborer, house 107 Chatham
- Loeffler, see Leffler [house r. 53 Atwater]
- Loennies Frederick, teamster, 14 St. Joseph,
- Loeser Barbara, widow, h. St. Joseph n. Norton
- Loewer Henry, lastmaker, Shawmut bldg. h. 1 Herman [Spencer]
- Logan Catharine, widow, house Frank cor.
- Logan James, carriage trimmer, 3 Canal, h. 355 Brown [Parkland]
- Logan James, gardener, bds. N. St. Paul n.
- Logan James (Logan & Creegan), house 9 Backus avenue
- Logan John, laborer, boards 5 Ely
- Logan John, sawyer, 2 Hill, h. 35 Lorimer
- Logan John, gardener, house N. St. Paul n. Parkland
- Logan Mary, boards 22 Brown's alley
- L**OGAN MILLIE BURTIS MRS. flower preserver and hair worker, 52½ North St. Paul, house do.—See page 520
- Logan Patrick, cooper, house 157 Frank
- Logan Thomas, joiner, house 93 Broadway
- Logan Thomas M. machinist, Brown's race near Factory, h. 5 Hand [Paul]
- Logan William, laborer, h. Beach n. N. St.
- Logan William T. frame joiner, Aqueduct, n. canal, house 52½ N. St. Paul
- Logan & Creegan (James Logan and John Creegan), street and sewer contractors, 152 Frank [Norton]
- Lohmaier Matthew, carpenter, h. Carter n.
- Lohmaier Michael, tinsmith, 97 St. Joseph, boards Carter n. Norton
- Lohmiller John, cabinetmaker, 184 State, h. W. Maple corner Colvin
- Lohmiller Joseph, bds. W. Maple c. Colvin
- Loisen Isaac, laborer, house 11 Huntington
- Loison John, packer, 74 State, h. 31 Rauber
- Loizeau Albert E. entry clerk, 16 Exchange, boards 25 Brown [h. do.]
- Loizeau Victorine Mrs. milliner, 25 Brown,
- Lomb Carl F. bookkeeper, Roch. German Ins. Co. W. Main c. Fitzhugh, boards 59 Fitzhugh [Paul, h. 15 Nassau]
- Lomb Ferdinand, optician, 179 North St.
- Lomb Henry (Bausch and Lomb Optical Co.), 179 N. St. Paul, house New York City
- Lombard Eliza J. Miss, clerk, b. 64 Bolivar
- Lombard see Lumbert
- Lommel Louis, tailor, house Bay n. Hebard

- Long Adam, frame maker, 38 Gorham, house
N. Clinton near Clifford
- Long Barbara, widow, boards 13 Ontario
- Long Catharine, widow, house 247 State
- Long Charles, gardener, house 98 Frances
- Long Charles W. F. removed to Port Huron,
Michigan
- Long Christian, foreman, house 104 Meigs
- Long David, cooper, house 14 Galusha
- Long George, mason, house 25 Buchan pk.
- Long Henry, bartender, boards 6 Kirk
- Long James B. tinsmith, 79 S. St. Paul, h.
69 Alexander
- Long John, laborer, house 199 Pinnacle av.
- Long Joseph, whip maker, Allen c. North
Washington, b. 122 Front
- Long Joseph, stonecutter, 54 Fitzhugh, house
27 Lowell
- Long Lawrence, removed from city
- Long Louis, boxmaker, 3 Aqueduct, bds.
131 Caledonia avenue
- Long Margaret, widow, house 122 Frost av.
- Long Marx, dry goods, 32½ Scio, house do.
- Long Mary, removed to Lockport
- Long Mary, domestic, 84 Lake avenue
- Long Michael, cooper, Magne n. R. R. bds.
Eighth
- Long Michael, house 15 Bay
- Long Nicholas, laborer, 27 North Water, h.
69 Whitney [c. Whitney
- Long Nicholas U. mason, house W. Smith
- Long Patrick, deceased [reservoir
- Long Robert, foreman, h. South avenue n.
- Long Rowland, machinist, Brown c. Jones,
house 40 Smith
- Long Thomas, leather dresser, h. 28 Olean
- Long Thomas, laborer, house 131 Caledonia
avenue
- Long William, framemaker, 43 N. Water,
house 131 Caledonia avenue
- Long William, ass't rector St. Luke's Church,
house 16 Clifton
- Long William, boards 27 Lowell
- Long, see Lang and Laing
- Longdo Joseph, hostler, house 5 Fullam's pk.
- Longdo Peter, laborer, boards 5 Fullam's pk.
- Longley Charles H. sec'y Rochester Wood
Pulp Co. at lower falls, b. 27 North St.
Paul
- Longmore Francis, hostler, h. 6 Montrose
- Longmore Nelson, sawyer, 102 Exchange, h.
rear 22 Griffith
- Longmore Nelson jr. boot crimper, boards r.
22 Griffith
- Lonsberry Charles, painter, house 76 Oak
- Look James A. foreman, 102 Exchange, h.
146 Exchange
- Loomis Byron E. removed to Woodland, Cal.
- Loomis Ira E. removed from city
- L**OOMIS ISAAC, architect, 44 Smith's
block, h. 22 Atkinson.—See page 511
- Loomis John, tailor, boards Goodman near
Monroe avenue
- Loomis John B. school books, h. 26 Tremont
- Loomis Martha, widow, h. Plymouth av. n.
Rapids
- Loop Eliza I. widow, h. 8 Greenwood av.
- Loop William R. boards 8 Greenwood av.
- Loos George, liveryman, 17 Division, boards
Whitcomb House [Ward
- Loos Nicholas, policeman, City Hall, h. 9
- Loper William H. laborer, Erie railway
freight house, h. 156 Champlain
- Lord Benjamin G. shoemaker, 91 N. Water,
house 89 Atkinson [Adams
- Lord Carrie C. clerk, 100 W. Main, bds. 117
- Lord Frank N. bookkeeper, 3 Smith's blk.
house 11 South Union
- Lord Franklin L. student, University of
Rochester, boards at Brighton
- Lord George D. 3 Smith's blk. house 44
Plymouth av.
- Lord George W. baggageman, h. 81 Atwater
- Lord George W. shoe cutter, 111 State, bds.
22 Julia [Lake avenue
- Lord Henry, millinery, 108 State, house 86
- Lord Henry F. removed from city
- Lord James H. conductor, N. Y. C. R. R.
house 19 North Washington
- Lord Jarvis & Co. (W. H. Ross Lewin), liquors,
69 Mill, house at Pittsford
- Lord Jotham, removed to Massachusetts
- Lord Lewis L. removed to Meadeville, Pa.
- Lord Matthias L. supt. Monroe Co. Insane
Asylum, house do.
- Lord William, shoemaker, house 22 Julia
- Lorentz Jacob F. laborer, h. r. 5 Tonawanda
- Lorentz John A. stove moulder, 20 Court, b.
23 Wilder
- Lorentz Mary E. widow, house 23 Wilder
- Lorey Albert, house 5 Goodman
- Lorey Frank J. tailor, 89 E. Main, boards 5
Goodman [5 Goodman
- Lorey Frederick J. tailor, 89 E. Main, bds.
- Lorey Joseph A. shoemaker, b. 5 Goodman
- Lorey William F. carriage painter, b. Monroe
avenue cor. Goodman
- Loritz Martin, carpenter, 14 St. Joseph, h.
30 Weeger
- Loritz Richard, carpenter, h. 56 Hanover
- Lorman Frederick, laborer, h. 19 Philander
- Lorman John, laborer, h. Dake n. First av.
- Lorson John, laborer, house 363 Brown
- Lorson John jr. switchman, Platt st. cross-
ing, b. 363 Brown [b. 363 Brown
- Lorson Peter, boilermaker, Brown c. Jones,
- Lortscher Frederick, laborer, bds. 58 North
Clinton [S. St. Paul
- Lortscher Jacob, roofer, 90 East Main, b. 50
- Losch Henry, clergyman, house 12 Vick pk.
- Losey Jesse D. machinist, boards 154 State
- Lothridge Mary A. widow, h. 34 Elizabeth
- Lothridge William H. telegrapher, N. Y. C.
R. R. depot, b. 34 Elizabeth
- Lotspike George F. printer, 82 West Main,
house 27 Jones [16 Scio
- Lotspike Sarah A. clerk, 113 East Main, bds.
- Lottridge Thomas S. salesman, h. 4 Seward
- Lotzer Christian, student, Rochester Theolog-
ical Seminary, boards 118 Alexander
- Loudan Frederick, carpenter, h. 34 North
Frances [Arcade, h. 134 Mt. Hope av.
- Loughborough William S. patent agent, 44
- Louisa Sister, teacher, b. Jay corner Frank
- Louk Ephraim, teamster, h. 36 Hamilton pl.
- Louk Leland E. teamster, b. 36 Hamilton pl.

HENRY C. WISNER,

WHITE CHINA DINING and TEA SETS,
No. 33 STATE STREET.

Louret Abraham, cartman, bds. 43 Charlotte
 Louret Abraham, pressman, 1 Aqueduct, h.
 13 Gardiner park [park
 Louret Mary, housekeeper, bds. 13 Gardiner
 Louret Sarah, widow, house 48 Tappan
 Love Arthur, teamster, house 13 Bloss
 Love Edward H. (*Farley & Love*), 32 S. St.
 Paul, boards 20 Bartlett
 Love Elizabeth, widow, bds. 258 East Main
 Love Elizabeth F. dressmaker, h. 258 East
 Main [87 Hickory
 Love Eugene, shoemaker, 73 N. Water, h.
 Love Frank, porter, b. Trowbridge n. Erie
 Canal [Frost avenue
 Love George, shoemaker, 124 Front, house 78
 Love James, shoemaker, Andrews cor. North
 Water, h. 53 Saxton [15 Ward
 Love James A. machinist, Brown c. Jones, h.
 Love John, printer, house 112 Adams
 Love John, cartman, house 20 Bartlett
 Love Michael, laborer, h. Trowbridge n. canal
 Love Patrick, deceased April, 1876
 Love Patrick jr. cutter, 29 E. Main, house
 202 North St. Paul
 Love Richard, laborer, house 59 Adams
 Love Robert, switchman, Erie Railway depot
 Love Royal, car coupler, house 65 West av.
 Love Stephen T. shoemaker, 79 N. Water,
 house 53 Prospect
 Love Thomas R. plumber, boards 20 Bartlett
 Love Thomas R. carpenter, bds. Trowbridge
 near canal
 Love William H. laborer, house 6 Marion
 Lovecraft Althea, widow, bds. 18 Mortimer
 Lovecraft John F. & Son (*S. J. Lovecraft*),
 planing mill, island opp. Mt. Hope av.
 house 8 Marshall
LOVECRAFT JOSEPH & SON (*J. E.*
Lovecraft), barrel head manufs. 92 Allen,
 house 220 Brown.—*See page 671*
 Lovecraft Joshua E. (*J. Lovecraft & Son*), b.
 220 Brown [boards 8 Marshall
 Lovecraft Sidney J. (*J. F. Lovecraft & Son*),
LOVECRAFT WM. hoops and staves, 92
 Allen, house 96 do.—*See page 671*
LOVEJOY IRA A. candy manufacturer,
 12 E. Main, house do.—*See page 566*
 Lovelace Nelson G. house 19 St. Clair
 Loveland Joseph, laborer, house 253 State
 Lovely George, gasfitter, b. Sanford n. Mt.
 Hope avenue
 Lovoney George F. gasfitter, bds. 9 Sanford
 Lovoney Richard, gardener, house 9 Sanford
 Loveridge George, broker, 53 Powers' bldgs.
 house 1 Nichols park
 Lovett George A. carpenter, h. 49 Hudson
 Lovett Isaac G. baggageman, N. Y. C. R. R.
 depot, house 22 Hickory
 Lovett William, fruit peddler, h. 22 Andrews
 Lovett William, carpenter, bds. 49 Hudson
 Low Emma, widow, house 203 Exchange
 Low Fenwick, removed to Philadelphia, Pa.
 Lowe Adam, flour packer, Crescent Mills, h.
 Murray c. Railroad [First
 Lowe Amelia F. widow, boards Mason n.
 Lowe Cornelius, teamster, Crescent Mills, b.
 49 Campbell [Elizabeth
 Lowe Horatio N. dentist, 1 Front, house 27

Lowe John, salesman, house 99 Smith
 Lowe Mary A. widow, boards 99 Smith
 Lowe Richard, carriagemaker, 4 Hill, house
 117 Tremont
 Lowe Samuel H. editor, Evening Express, 23
 West Main, house Mason near First
 Lowell Azubia, widow, house 45 Andrew
 Lowell Edwin A. clerk, 79 E. Main, boards
 35½ Charlotte
 Lowell William M. shoemaker, h. 12 Stone
 Lowenberg Esther, widow, bds. 6 Clinton pl.
 Lowensohn Moritz S. salesman, h. 107 North
 Clinton [12 Canal
 Lowenthal David E. prof. of languages, bds.
 Lowenthal George, foreman, 10 Mumford, h.
 20 Pearl [40 State, bds. 79 William
 Lowenthal Louis (*Shatz, Lowenthal & Leiter*),
 Lowenthal Max (*Lowenthal & Ettenheimer*),
 house 79 William
 Lowenthal Sophie, widow, b. 33 Clinton pl.
LOWENTHAL & ETTENHEIMER (*M.*
Lowenthal and M. Ettenheimer), knit
 goods and yarns, 10 Mumford.—*See*
page 544
 Lowery Johanna, widow, h. 19 Champlain
 Lowery John, shoemaker, Andrews c. North
 Water, boards 18 Seward
 Lowery Thomas, blacksmith, b. 121 Adams
 Lowery William, fireman, Erie Railway, h.
 153 Fitzhugh
 Loweth Charles W. grocer, 77 Adams, h. do.
 Loweth William G. hostler, 67 Plymouth av.
 boards 77 Adams
 Lowhoff Johanna, house 48 St. Joseph
 Lowrey Daniel (*Lowrey & Bradner*), house 58
 East avenue
 Lowrey Frances J. dressmaker, b. 22 Allen
 Lowrey & Bradner (*Daniel Lowrey and A. H.*
Bradner), morocco manufs. 23 N. Water
 Lowry Anna M. teacher, Hudson School,
 No. 16, house 2 Gardiner pk. [128 do.
 Lowson Frederick, tailor, 40 E. Main, house
 Loy Francis, clerk, house 17 Webster
 Loy John, painter, house 24 Grape
 Loy Peter, laborer, house 7 Romeyn
 Loy Peter, gardener, boards 24 Grape
 Loysen Abraham, umbrella repairer, house 6
 Stepheny's park [house 1 Murray
 Loysen Abraham jr. varnisher, 44 East Main,
 Loysen Alexander, finisher, 74 State, house
 83 Kelly [8 Stepheny's park
 Loysen Cornelius, sashmaker, Aqueduct, h.
 Loysen Daniel, finisher, 73 North Water, bds.
 6 Stepheny's park
 Loysen Peter, shoemaker, N. Water corner
 Andrews, house rear 6 Stepheny's park
 Loysen Jacob, machinist, Brown cor. Jones,
 house 8 Almira [16 Harvard
 Lozier Murray, clerk, 195 Monroe av. boards
 Lozier Schuyler, salesman, boards 37 Adams
 Lubs Mary, widow, boards Berlin n. Hudson
 Lucas Alexander, peddler, house 15 Anson pk.
 Lucas Charles, laborer, house 75 Cypress
 Lucas Edgar D. shoemaker, N. Water cor.
 Andrews, boards 21 Swan
 Lucas Frederick A. naturalist, boards 2
 College avenue [9 Eagle
 Lucas George H. bookkeeper, 73 State, bds.

A. R. PRITCHARD & LIKLY,

SHAWL STRAPS,
 No. 78 STATE STREET.

Lucas Henry G. deceased January 2, 1876
 Lucas John, laborer, boards 75 Cypress
 Lucas Margaret, boards 15 Anson park
 Luce Clifford A. salesman, 16 State, boards 41 Chestnut
 Luce Creighton R. mason, h. Tappan c. Scio
 Luce George W. brakeman, N. Y. C. R. R. house 4 Woodbury
 Luce Mary E. widow, house 41 Chestnut
 Luce Sophia Miss, forewoman, 124 Front, boards 7 Jay
 Luchsinger Adam, tailor, house 82 Reynolds
 Lucier Abraham, carpenter, house rear 85 Broadway
 Luck George T. laborer, h. 17 Stepheny's pk.
 Luck Henry J. laborer, b. 17 Stepheny's pk.
 Lucket John J. (*Luckett & Horner*), house 27½ Munger
 Luckett & Horner (*J. J. Luckett and J. Horner*), blacksmiths, 133 S. St. Paul
 Luckey Caroline, widow, h. Hume n. Genesee
 Luckey D. Foster, baker, house 117 Adams
 Luckey Emma A. Miss, dressmaker, boards Hume near Genesee
 Luckey Joseph L. (*Darg & Luckey*), 106 Powers' buildings, house 27 Ambrose
 Luckey Samuel M. clerk, post office, house 33 South
 Luckhurst Napoleon, carpenter, h. 9 Swan
LUCREE MORRIS, turner, Ames corner Campbell house do.—*See page 590*
 Lucy Sarah M. widow, b. Munger n. Whalin
 Ludington Cornelius S. carpenter, Jones av. cor. Saratoga av. house rear 195 Oak
 Ludlan Joseph E. stenographer, 15 Powers' buildings, house 26 Emerson
 Ludlow Walter W. compositor, 3 West Main, boards 9 North avenue [b. 5 Grove
 Ludlow Washington I. 61 Powers' buildings,
 Ludlum Myron C. real estate, 37 Powers' buildings, house at Newark
 Ludwig Charles, deceased 1875
 Ludwig, see Ladwig
 Luetchford Arthur, bookkeeper, Mechanics' Savings Bank, 15 Exchange, house 109 Alexander [University av.
 Luetchford Carrie, seamstress, boards 139
 Luetchford Charles, printer, 1 East park, b. 139 University avenue
 Luetchford Charles, carpenter, house 139 University av.
 Luetchford Marion, seamstress, boards 139 University avenue [house 41 Wilder
 Luethy Charles, bookkeeper, 69 N. St. Paul,
 Luethy Charles J. cigarmaker, Mill corner Factory, boards 41 Wilder
 Luhm Jacob, silver plater, 3 Canal, house 32 Pinnacle avenue [Hague
 Luig Caspar, sawyer, boards West Maple c.
 Luig Frederick, laborer, house West Maple n. Hague
 Luig Gustav, painter, 30 Buchan park, h. do.
 Luig Samuel, farmer, b. W. Maple n. Hague
 Luikaart Martin, laborer, Paper Mill, house Clifford near Henry [West Maple
 Luis Theodore C. cutter, 14 Mumford, h. 74
 Luitwieler Cornelia Miss, h. 15 Hamburg
 Luitwieler Eliza, widow, h. 98 University av.

Luitwieler Emma J. clerk, 48 State, boards 98 University avenue
 Luitwieler Jacob G. paints, 82 East Main, house 80 East avenue [b. 80 East av.
 Luitwieler James H. salesman, 73 E. Main,
 Luitwieler Maria, widow, boards 2 Ambrose
 Luitwieler Mary, widow, h. Scio n. East av.
 Luitwieler Philander T. clerk, 82 East Main, boards 80 East avenue [Meigs
 Luitwieler Samuel W. clerk, 82 E. Main, h. 81
 Lukassy Casper Mrs. house 47 Ontario
 Lull Orrin, saw filer, house 6 South Ford
 Lumbert Helen, widow, b. Adams n. Reynolds
 Lambert Michael, driver, steamer No. 1, 36 Stone, house 18 do.
 Lundy Daniel S. wringer manuf. West av. cor. Wentworth, house do. [ington
 Lung Julius C. physician, boards 9 N. Wash-
 Lurz Joseph, carpenter, house 5 Leopold
 Luscher Adolph, optician, 179 N. St. Paul, house 51 Ontario
 Luscher August, removed from city
 Luscher Emil G. removed to Lyons
 Luscher Francis, teamster, Alexander near canal, house 66 Pearl
 Luscher Rudolph 2d, silver plater, 3 Canal, boards 34 Pinnacle avenue
 Luscher Samuel, saloon, 34 Pinnacle av. h. do.
 Lush William F. policeman, City Hall, house 293 Brown
 Lush William J. box maker, bds. 293 Brown
 Lusink Albert B. carpenter, 93 Exchange, boards 4 Putnam
 Lusink Carrie, domestic, bds. 25 South Union
 Lusink Embert, painter, 9 West Main, house Hudson near Berlin [4 Putnam
 Lusink Henry J. painter, 9 W. Main, house
 Lusink Jane, widow, boards Hudson n. Berlin
 Lusink Richard, driver, Clinton Hotel, b. do.
 Lusink William, painter, boards 1 Tyler
 Lusk Alfred D. agent, 12 Allen, h. Sibley's blk.
 Lusk Lewis, agent, house 321 State
 Lusk Lottie N. Miss, milliner, 83 East Main, boards 51 Chestnut [bds. 54 do.
 Luther David, carpenter, rear 54 North av.
 Luther Georgiana, domestic, bds. Nichols pk.
 Luther Gertrude, widow, house 54 North av.
 Luther Jane, widow, boards 49 Pearl
LUTHER JOHN, carpenter and builder, rear 54 North av. house 54 do.—*See page 636*
 Luther William, house 19 Alexander
 Lutt George J. clerk, 112 W. Main, bds. do.
 Lutt Jacob, saloon, 112 W. Main, house do.
 Luttringer Augustus, carpenter, house Saxton corner Orange
 Lutwiler Frederick L. carriage trimmer, 3 Canal, bds. 12 Litchfield [Litchfield
 Lutwiler John J. sawyer, 3 Canal, house 10
 Lutwiler Margaret, widow, h. 12 Litchfield
 Lutwiler Margaret Miss, sewer, boards 12 Litchfield [do.
 Lutz Charles, laborer, 154 North avenue, b.
 Lutz Felix, clerk, 34 Herman, boards do.
 Lutz Jacob, tanner, house 25 Sanford
 Lutz John, deceased December, 1875
 Lutz Joseph, laborer, house Evergreen near Conkey avenue

- Lutz Sabina, widow, h. Clifford opp. North
Lux Jacob, harness maker, 5 Market, house
67 Lyell
Luxton William, painter, boards 21 William
Lyll Charles D. moulder, 8 Hill, bds. 9 do.
Lyddon Thomas J. grocer, 19 Clifford, h. do.
Lyddon William H. compositor, 3 W. Main,
house 176 Jay
Lyle Robert W. engineer, 134 Oak, b. 191 do.
Lyle Sarah, widow, boards 32 Asylum
Lyle William, foreman, 134 Oak, h. 191 do.
Lyle Wm. J. moulder, 134 Oak, bds. 191 do.
Lynagh Anna, dressmaker, b. 70 Manhattan
Lynch Catharine, widow, house 27 Marietta
Lynch David, laborer, house 80 South av.
Lynch Edward, maltster, house 34 Hunter
Lynch Ellen, domestic, 2 Fulton avenue
Lynch Felix, shoemaker, 4 Allen, house 80
Ontario
Lynch Henry P. machinist, boards 41 Oak
Lynch James jr. machinist, Brown's race n.
Furnace, house 180 North St. Paul
Lynch James H. stonecutter, 175 S. St. Paul,
boards 61 Front [Henrietta av.
Lynch James O. laborer, h. Pinnacle av. n.
Lynch John jr. (*Lynch & Arnold*), boards 15
Caroline
Lynch John, laborer, house 59 Munger
Lynch John, laborer, house 10 Moore
Lynch John, grocer, 75 South av. house do.
Lynch John, laborer, house 63 Bolivar
Lynch Joseph C. clerk, boards Magnolia n.
Genesee [Ford
Lynch Kate (*Lynch & McMullen*), b. 74 South
Lynch Kate T. widow, house 71 Tremont
Lynch Margaret, widow, boards 6 Hunter
Lynch Maria W. widow, house 41 Oak
Lynch Mary, boards 80 South avenue
Lynch Mary, tailoress, b. Magnolia n. Genesee
Lynch Michael, laborer, h. Lake av. c. Lyell
Lynch Owen, stonecutter, 22 West av. house
Trowbridge near Erie canal
Lynch Patrick H. carriage maker, house 45
St. Joseph
Lynch Philip, sawyer, boards 1 Lowell
Lynch Sarah B. dressmaker, b. 75 South av.
Lynch Thomas, shoemaker, h. Ames n. R. R.
Lynch Thomas, detective, City Hall, house
23 Romeyn
Lynch Thomas, grocer, 66 Frances, h. do.
Lynch & Arnold (*J. Lynch jr. and P. Arnold*),
hairdressers, 11 South avenue
Lynch & McMullen (*K. Lynch and J. McMul-
len*), hairwork, 5 Baker's block
Lyndon Francis, peddler, h. 86 Caledonia av.
Lyndon Frank P. carriage trimmer, 3 Canal,
bds. 86 Caledonia avenue
Lyndon Julia G. teacher, Genesee School,
No. 4, boards 86 Caledonia avenue
Lyness Frances, widow, house 32 Chatham
Lyness George, tanner, boards 32 Chatham
Lyness George W. packer, 33 State, boards
72 Atwater
Lyness John, cartman, house 72 Atwater
Lyness Thomas, boards 72 Atwater
Lynn Archibald, well digger, house Genesee
near Hunter [av.
Lynn Ellen, widow, house rear 76 Mt. Hope
Lynn Martin, shoemaker, 87 North Water,
house rear 76 Mt. Hope avenue
Lynn Michael J. engineer, h. 94 North av.
Lynn Thomas S. carpenter, h. 22 avenue D.
Lynn Albert J. student, Rochester Theologi-
cal Seminary, boards Trevor Hall
Lyon Charles L. limeburner, b. 37 Glasgow
Lyon Edmund, student, University of Roch-
ester, boards Brighton
Lyon Edmund, house 91 Fitzhugh
Lyon Edward L. physician, h. 2 Joslyn park
Lyon Eunice, widow, boards 34 Fitzhugh
Lyon Mary, widow, boards 45 Lyell
Lyons Barbara Miss, bds. 14 North Frances
Lyons Ellen Mrs. boards 53 Orange
Lyons Emanuel, watchman, h. Childs c. R. R.
Lyons George, hostler, 89 Mill, house do.
Lyons Henry, cabinetmaker, b. Childs c. R. R.
Lyons James S. painter, house 263 State
Lyons Jennie Miss, clerk, boards 3 South
Lyons Jennie M. Miss, house 263 State
Lyons Jeremiah, painter, 3 Canal, house 98
Adams
Lyons John, machinist, house King c. Brown
Lyons Joseph H. shoemaker, bds. 12 North
Washington
Lyons Josephine, boards 263 State
Lyons Margaret, widow, house 42 Atkinson
Lyons-Mary E. boards 263 State
Lyons Michael, laborer, boards 89 Front
Lyons Sarah A. Miss, dressmaker, 263 State,
house do.
Lyons William, laborer, house 105 Childs
Lyons William H. cartman, house 41 York
Lysaght Bridget Mrs. house 174 Exchange
Lysaght James Mrs. house 65 West avenue
Lysaght James, removed from city
Lysaght Mary, widow, boards 174 Exchange
Lytle Frank, laborer, house Childs alley near
Erie canal
Lytle George, laborer, house 26 Hill
Lytle Alice G. housekeeper, 3 Ambrose
- MAASS CHARLES, blacksmith, h. 20 Hoeltzer
MABBETT ALONZO L. real estate, 32
Arcade, house 29 Tremont.—*See inside
front cover*
Mabbett Joseph I. baker, house 12 King
Mabus Henry, blacksmith, house 6 Hope
Mabus John E. screwmaker, 123 Mill, bds.
6 Hope
MacAfee Burton, student, University of Ro-
chester, b. 31 Troup [b. Osburn House
Macaloon Anna, domestic, 12 N. St. Paul,
Macanty Frank, laborer, b. 49 University av.
Macanty Mary, widow, h. 49 University av.
Macauley Antoinette, widow, h. 24 Chestnut
Macauley Mary E. teacher, bds. 15 Vine
Macauley Nancy Miss, house 21 Savannah
Macauley Richard, house 15 Vine
Mace Hannah C. widow, b. 29 Gregory
Macey Roxana Mrs. house 238 East Main
Macfarlane Edward O. coal, 33 Powers'
bldgs. h. 6 Lamberton park
MACFARLANE JAMES, wholesale coal
dealer, 33 Powers' bldgs. h. at Towanda,
Pa.—*See page 601*
Macher Max, salesman, 17 State, b. 8 Kent

- Macherell Johanna, widow, h. 37 Monroe av.
 Machholz Rudolph, student, Rochester Theological Seminary, h. 84 Weld
 Machia Emily, boarding house, 9 Otsego
 Machia Henry, laborer, boards 9 Otsego
 Machiea Mary J. dressmaker, bds. 9 Otsego
 Machiea Max, salesman, boards 8 Kent
 Machin Charles A. photographer, 14 State, boards 18 East avenue.
 Machin Philip, mason, h. 252½ N. Clinton
MACNEALE & URBAN, Cincinnati safes and locks, 6 Corinthian Hall bldgs.—
See page 679
 Mack Adam, blacksmith, h. 17 Hawkins
 Mack A. C. salesman, 74 Mill, house do.
 Mack Elizabeth A. widow, boards Exchange corner Adams
 Mack Frank M. (*Curtice Bros. & Mack*), N. Water n. Andrews, bds. 366 S. St. Paul
 Mack Henry, baker, 171 Scio, boards do.
 Mack John, laborer, h. Child's alley near Erie canal [Clinton pl.
 Mack John J. (*Mack & Co.*), 136 Mill, h. 37
 Mack Katie, housekeeper, house 43 Marshall
 Mack Mary J. (*Eagan & Mack*), 4 Elwood block, boards 76 Troup
 Mack Royal L. (*Mack & Co.*), 136 Mill, house 42 S. Clinton [13 Clinton place
 Mack William R. bookkeeper, 136 Mill, bds.
 Mack Wm. W. (*Mack & Co.*), 136 Mill, house 13 Clinton place
 Mack & Co. (*W. W., R. L. and J. J. Mack*), edge tool manufacturers, 136 Mill
 Mackarine Henry, laborer, h. 338 Brown
 Mackay Geo. deceased Dec. 12, 1875
 Mackay George Mrs. widow, house 14 Stone
 Mackert Albert, tailor, 9 Hanover, h. do.
 Mackert John, deceased Sept. 1875
 Mackey Edward C. packer, 39 State, house 39 George [Plymouth av.
 Mackey Lawrence, laborer, house Cottage n.
 Mackie G. B. mason, boards 94 N. Clinton
 Mackie Henry S. music store, 82 State, house 50 Park avenue
 Mackie Jane, widow, boards 13 East
 Mackin William, coachman, h. 6 Lawrence
 Mackintosh, see McIntosh [h. 34 Sherman
 Mackwood James, cooper, 1 St. James park,
 Macomber Fannie S. widow, house 53 Court
 Macomber Francis A. lawyer, 78 Powers' bldgs. house 5 Prince
 Macormic Edward C. fireman, N. Y. C. R. R. h. 65 Hudson
 Macorquodale Hugh, photographer, 44 State, boards 11 N. St. Paul [Fulton av.
 Macy Philander, dentist, 110 State, house 19
 Madden Ann J. widow, h. Reynolds corner Marion
 Madden Bridget, widow, house 37 Joiner
 Madden Charles M. student, 110 Powers' bldgs. boards 34 Jones [place
 Madden Elizabeth A. clerk, bds. 3 Hamilton
 Madden Francis A. clerk, house 71 Tremont
 Madden Francis J. shoemaker, 83 N. Water, boards Reynolds c. Marion
 Madden Garrett A. 247 State, bds. Delevan corner Scio
 Madden James, tailor, 247 State, h. 34½ Jones
 Madden Jennie Miss, teacher, Andrews School, No. 9, b. 128 N. St. Paul
 Madden John, painter, house 3 Hamilton pl.
 Madden John, laborer, boards 46 Smith
 Madden John, cutter, 1 Front, h. 67 Delevan
 Madden John L. salesman, 73 E. Main, bds. 34 Jones
 Madden Mary Miss, house 128 N. St. Paul
 Madden Mary, widow, house 4 Campbell
 Madden Michael, peddler, house 60 Pearl
 Madden Michael, removed from city
 Madden Patrick J. plumber, 48 East Main, boards Reynolds cor. Marion [95 Jay
 Maddicks W. Powel, clerk, 4 West Main, b.
 Maddock Elizabeth Miss, dressmaker, 77 State, house do. [51 Orange
 Mader Joseph, marble polisher, 166 State, h.
 Mader Thomas, builder, h. Violetta corner Mansion
 Madgerwick Wm. A. painter, 10 Front, house 2 Garden
 Madigan Ann, widow, house 8½ Stone
 Madigan John, cartman, house Mt. Vernon av. cor. Lewis
 Madigan Margaret, cigarpacker, b. 8½ Stone
 Madigan Mary, domestic, bds. 85 Broadway
 Madison Charles, clerk, b. 22 N. St. Paul
 Madison Henry, carriage driver, Osburn House [Grand
 Madler Philip, furnaceman, 8 Hill, house 12
 Maeer Rosa, widow, boards 352 Brown
 Maeder Ernest, saloon, Jay cor. Oak, h. do.
 Maeder John, mason, h. Childs near Lime
 Maeder John G. student, Rochester Theological Seminary, bds. 118 Alexander
 Maeder Lawrence, sawyer, 111½ N. Water, boards Childs near Lime [h. 64 Pearl
 Maffet Frederick W. silversmith, 2 E. Main,
 Magan Delia, employe, Osburn House
 Magdelin Edmond C. draughtsman, 73 Arcade, boards 7 William
 Magill Patrick H. bookkeeper, 83 N. Water, boards 142½ West Main
 Magin Charles, cabinetmaker, 133 N. Water, house Clifford near N. Clinton
 Magin Conrad, boards 5 Union alley
 Magin Frank, laborer, house Clifford near Conkey avenue [Oakman
 Magin George, laborer, house Galusha near
 Magin George, laborer, 139 N. St. Paul, h. 38 Oakman [Alphonse n. Thomas
 Magin Hieronimus, laborer, C. B. Hill's. h.
 Magin Jerome, cabinetmaker, 133 N. Water, boards 17 Clifford
 Magin Joseph, saloon, 198 N. Clinton, h. r. 178 do. [h. 6 Clifford
 Magin Martin, shoemaker, 7 South St. Paul,
 Magin Michael, saloon, 5 Andrews, h. do.
 Maginn John, cabinetmaker, 184 State, bds. 17 Clifford
 Magranda Johanna, widow, h. 16 Holland
 Magrane Geo. A printer, bds. 111 Fulton av.
 Magrane Lizzie, stitcher, b. 111 Fulton av.
 Magrane Margaret, widow, h. 111 Fulton av.
 Magson Annie, tailoress, h. 44 South avenue
 Magson Elizabeth, widow, house 60 Griffith
 Magson Israel, carpenter, Court street bridge, boards 60 Griffith

Maguire James, boards 40 Spencer
 Maguire Mary A. widow, house 49 Davis
 Maguire Mary J. stitcher, boards 40 Spencer
 Maguire Patrick, cooper, house 40 Spencer
 Maguire, see McGuire
 Mahaney Daniel, miller, boards 37 Litchfield
 Mahaney Jeremiah, laborer, h. 53 Park av.
 Mahaney Margaret, nurse, house 37 Litchfield
 Maher Alice, widow, house 66 William
 Maher Anna A. dressmaker, bds. 44 Romeyn
 Maher Edward, carman, house 56 Marshall
 Maher Edward, cooper, b. Whitney n. Lyell
 Maher Edward A. machinist, 100 S. St. Paul,
 house 12 Manhattan [b. 66 William
 Maher Edward F. gasfitter, 25 Exchange,
 Maher Edward J. cashier, 64 State, b. 81 Jay
 Maher Elizabeth Miss, house 21 Brown's al.
 Maher James, telegrapher, 34 Arcade, boards
 66 William [39 Gregory
 Maher James H. plumber, 8 Mumford, house
 Maher Jeremiah, carpenter, house 50 Munger
 Maher John, laborer, boards 139 S. St. Paul
 Maher John, grocer, 44 Romeyn, h. do. [do.
 Maher John C. shoemaker, 340 State, b. 348
 Maher John J. clerk, 73 E. Main, boards
 66 William [boards do.
 Maher Maria J. music teacher, 44 Romeyn,
 Maher Michael, cooper, b. Whitney n. Lyell
 Maher Michael J. clerk, 16 Exchange, house
 39 Whitney [81 Jay
 Maher Thomas F. salesman, 16 Exchange, b.
 Maher William, laborer, h. Whitney n. Lyell
 Maher William, salesman, house 81 Jay
 Maher William, teamster, boards 71 Reynolds
 Maher William E. plumber, b. 56 Marshall
 Maher Wm. F. butcher, b. Whitney n. Lyell
 Maher, see Meagher [enna, house do.
 Mahle Elizabeth Mrs. hairworker, 6 Vi-
 Mahle Ferdinand, carpenter, 100 S. St. Paul,
 house 6 Vienna
 Mahle Frederica Miss, boards 68 St. Joseph
 Mahle Louis, dry goods, 68 St. Joseph, h. do.
 Mahle Mary, deceased June, 1875
 Mahler Frederick, cabinetmaker, 7 N. Water,
 house 35 Wilder
 Mahler John U. blacksmith, h. 71 Herman
 Mahlzacher Leopold, hairdresser, Whitcomb
 House, boards 12 N. Clinton
 Mahns Frank, butcher, 3 Hudson, bds. do.
 Mahon Alderman D. salesman, bds. 3 Union
 corner Griffith
 Mahon James, laborer, h. 38 Munger [do.
 Mahon John, grocer, Frances c. Tremont, h.
 Mahon John, laborer, house 15 Almira
 Mahon John J. bookkeeper, 29 W. Main, b.
 Frances cor. Tremont
 Mahon Patrick (*Burke, Fitz Simons, Hone &*
Co.), 53 E. Main, house 78 East avenue
 Mahon Patrick, coremaker, rear 204 State,
 boards 38 Munger
 Mahoney Augustus L. laborer, b. 57 Gregory
 Mahoney Daniel, laborer, house 57 Gregory
 Mahoney Dennis, horse trainer, h. 278 State
 Mahoney Edward, laborer, h. Lyell n. R. R.
 Mahoney Edward, boilermaker, Platt corner
 Kent, boards 51 Saxton
 Mahoney Eliza, widow, house 23 Walnut
 Mahoney George, laborer, b. 139 S. St. Paul

Mahoney George, laborer, boards 57 Gregory
 Mahoney Hannah C. stitcher, b. 22 Lake av.
 Mahoney Hannah C. widow, b. 22 Lake av.
 Mahoney John, tailor, house rear 28 Stone
 Mahoney John, laborer, boards 57 Gregory
 Mahoney Mary, widow, house Magnolia near
 Plymouth avenue [N. Clinton
 Mahoney Michael, tailor, 57 State, house 121
 Mahoney Michael, laborer, h. 135 S. St. Paul
 Mahoney Patrick J. tailor, 57 State, h. do.
 Mahoney Thomas, grocer, 270 Plymouth
 avenue, house do. [Union
 Mahr George, shoemaker, h. Lewis n. North
 Mahr Rudolf L. tallyman, Erie R'y freight
 house, house 86 Cady [71 Allen
 Maichle Ulrich, carriagemaker, 3 Canal, h.
 Maid Andrew, tailor, boards 114 Orange
 Maid Charles (*F. Wolff & Co.*), house Lyell
 opposite Sherman [b. 123 Lyell
 Maid Frank, morocco dresser, 29 N. Water,
 Maid Geo. L. soapmaker, 27 North Water,
 house 114 Orange
 Maier Anton, student, Roch. Theological
 Seminary, boards 118 Alexander
 Maier Conrad, tailor, h. 75 Orange [Clifford
 Maier Frank, tinsmith, 228 N. Clinton, b. 3
 Maier Hieronymus, farmer, house 3 Clifford
 Maier John E. cabinetmaker, 7 North Water,
 house 39 Buchan park [h. 19 Orange
 Maier John U. bookkeeper, Mill c. Factory,
 Maier Leonard, carpenter, h. Jay c. Orchard
 Maier Louis W. (*Foehner & Maier*), 4 North
 Clinton, h. 41 Buchan park
 Main Eliza A. Miss, house 55 South Clinton
 Mains John, house 16 Smith
 Mains William, watchman, Brown cor. Erie
 canal, boards 23 Brown
 Mair William, tailor, h. 15 Cypress [House
 Maitland Margaret, chambermaid, Osburn
 Maitland Percy, photograph colorist, 31
 Chestnut, house do. [4 Stepheny's pk.
 Major Emanuel, gasfitter, 117 W. Main, h.
 Major George, mason, house 170 Jay
 Major George C. laborer, house 176 Jay
 Major James P. boarding, house 97 1/2 E. Main
 Major Wm. H. salesman, 92 State, h. 280 do.
 Majusen Minnie, widow, bds. Thomas near
 Clifford [40 Brown's alley
 Malampy Michael, laborer, 65 N. Water, b.
 Malampy Patrick, brewer, boards 37 Platt
 Malany John R. house 2 Emerson [Hickory
 Malben Benjamin, boat builder, house 82
 Malben Victoria, domestic, bds. 82 Hickory
 Malcom John, lastmaker, 81 North Water,
 house 58 Manhattan
 Malcom James, last maker, Shawmut bldg.
 boards 60 Manhattan [Thompson
 Malcomson Joseph H. teamster, boards 13
 Malcomson Martha, dressmaker, boards 18
 Thompson [Thompson
 Malcomson Richard, carman, house 13
 Malcomson William J. laborer, boards 13
 Thompson
 Male Charles, nurse, City Hospital, bds. do.
 Male Wm. carpenter, Jones av. c. Saratoga
 avenue, house White corner Frank
 Maley Nora, widow, h. N. Union n. railroad
 Malican Francis, watchman, house 132 Jay

- Malican Matthias, switchman, Dean st. crossing, house 14 do. [boards 182 Jay
 Malican Michael J. tinsmith, Brown c. Jones,
 Mall John, laborer, h. St. Joseph n. Clifford
 Malley Ellen Miss, vampe, boards 11 Terry
 Malley James, shoemaker, 4 Allen, h. 7½ Jay
 Malley Michael, laborer, h. 11 Terry [Joseph
 Mallie Isaac, laborer at Gas Works, h. 225 St.
 Mallie Isaac, hatter, boards 15 Goodman
 Mallie Isaac D. painter, 74 Arcade, bds. 225
 St. Joseph
 Mallie Abraham, laborer, house 15 Goodman
 Mallie —, farmer, rear Lake av. n. tollgate
 Mallien Elizabeth, shoefitter, h. 136 S. St.
 Paul
 Mallory Mary, widow, house 5 Marshall
 Malloch Isabella, deceased June 25, 1875
 Mallock John jr. boards 79 State
 Malloch Maggie, removed from city
 Mallon Bridget, dressmaker, 28 Centre, h.
 96 State [5 Chatham
 Mallon Edward J. shoemaker, 111 State, b.
 Mallon Patrick, carpenter, h. 4 N. Stillson
 Mallon Patrick J. packer, boards 28 Centre
 Mallory Elmer C. assistant supt. Children's
 Home, 263 N. St. Paul, b. do. [Tappan
 Mallory Frank R. bluing, 57 State, boards 89
 Mallory Gilbert S. carpenter, bds. 230 North
 Mallory Harriet, widow, h. 55 Sibley's block
 Mallory James, sawyer, h. Fairmount near
 University avenue [boards do.
 Mallory Maitland L. physician, 12 Fitzhugh,
 Mallory Orlando, agent, box manuf. 57 State,
 house 89 Tappan
 Mallory Susan L. widow, boards 89 Tappan
 Malloy Annie T. stitcher, boards 9 Saxton
 Malloy Frank, gasfitter, boards 9 Saxton
 Malloy James, switchman, N. Y. C. R. R.
 house Huron near Hebard
 Malone Albert L. bookkeeper, Bank of Mon-
 roe, 22 Exchange, house 24 Martin
 Malone Anna, widow, house Saxton n. Lyell
 Malone Catharine, stitcher, b. Saxton n. Lyell
 Malone Hannah, widow, house 36 Platt
 Malone Henry, removed to Lockport [der
 Malone John L. woodworker, b. 58 Alexan-
 Malone Mary E. teacher, Whitney School,
 No. 17, boards 6 Clifton
 Maloney Ellen Mrs. widow, house 23 Bolivar
 Maloney Frank S. clerk, 108 State, b. Centre
 corner Otsego
 Maloney John, machinist, house 3 Wait
 Maloney John T. hostler, 90 N. Water, h. 36
 Andrews
 Maloney Michael, laborer, house 7 Gorham
 Maloney Michael J. milk, h. 18 Woodbury
 Maloney Michael J. fancy goods, 94 State,
 boards 56 Marshall [University av.
 Maloney Michael M. house Anderson av. n.
 Maloney Michael M. jr. switchman, b. An-
 derson avenue near University avenue
 Maloney M. A. Mrs. millinery, h. 56 Marshall
 Maloney Patrick, foreman, h. 2 Shamrock
 Maloney Patrick, baggage-man, N. Y. C. de-
 pot, house 13 Shamrock
 Maloney Thomas, laborer, house 18 Munger
 Maloney Thomas K. clerk, 53 E. Main, bds.
 23 Bolivar
 Maloney William, switchman, b. Anderson
 av. n. University av.
 Malony John T. hostler, 88 N. Water, bds.
 N. Water near East Main
 Malony Patrick, laborer, house 92 Front
 Malony, see Maloney, and Moloney
 Maloy Charles H. tinner, 108 West Main, h.
 30 Hunter
 Maloy John, deceased September, 1875
 Maloy Josephine, shoemaker, bds. 9 Saxton
 Maloy Martin, saloon, 36 Kent, b. 35 South av.
 Maloy Matthew, switchman, house 43 Lewis
 Maloy Michael A. blacksmith, bds. 9 Saxton
 Maloy Patrick, laborer, house 9 Lime
 Maloy Patrick, switchman, boards 43 Lewis
 Maloy, see Mayloy
 Maltby Clark O. student, h. 190 Monroe av.
 Maltby George W. supt. stone yard, 54 Fitz-
 hugh, house 19 Tremont
 Maltby John W. trussloop maker, rear 62
 East avenue, house 131 University av.
 Maltby John W. Mrs. hairworker, 131 Uni-
 versity avenue, house do.
 Maltry John, stone cutter, boards 120 Front
 Maltzahan Louis, laborer, house 2 Bay
 Maltzahan William J. saloon, Bay n. North
 avenue house do. [house 39 Weld
 Malville Earnest, blacksmith, 4 College av.
 Malville Henry E. french cook, h. 37 Weld
 Managan Eugene J. (*Williams & Managan*),
 132 East Main, boards 67 Andrews
 Managan Margaret J. widow, h. 67 Andrews
 Managh Katie, seamstress, bds. r. 272 State
 Manahan Charles, brakeman, N. Y. C. R. R.
 boards 173 North avenue [N. Union
 Manahan James L. agent, 94 E. Main, house
 Manchester George W. nursery stock, h. 78
 Monroe avenue
 Manchester James, painter, house 95 Scio
 Manchester Mary A. Mrs. dressmaker, 78
 Monroe avenue, house do. [Paul, h. do.
 Mandery Leonhard, shoemaker, 84 S. St.
 Mandeville Alfred R. clerk, 115 E. Main, b.
 9 Chestnut pk. [E. Main, h. 32 North av.
 Mandeville Austin & F. A. physicians, 96½
 Mandeville Charles H. clerk, 13 E. Main, h.
 64 Scrantom n. N. Clinton [diner pk.
 Mandeville Elizabeth A. widow, h. 22 Gar-
 Mandeville Fred. A. (*A. & F. A. Mandeville*),
 boards 32 North av. [h. 9 Chestnut pk.
 Mandeville John C. salesman, 53 East Main,
 Mandeville Libbie M. widow, b. 18 Arnold
 park [boards 224½ E. Main
 Mandeville Lucius M. printer, 18 W. Main,
 Mandeville Wesley, salesman, 147 State, h.
 24 Mathews [h. 22 Gardiner pk.
 Mandeville Wilber J. clerk, Minerva alley,
 Mandeville William F. house 2 W. Troup
 Mandle Joseph, flour, 27 Hanover, house 30
 Vienna
 Mangin John, tucker, house 33 Baden
 Manley John P. painter, 49 Nassau, h. do.
 Manley William, shoe patterns, 111½ North
 Water, h. do. [State, h. 31 S. Clinton
 Mann Abram S. (*A. S. Mann & Co.*), 17
 Mann Albert, locksmith, 29 S. St. Paul, bds.
 3 Scrantom
 Mann Alexander, laborer, h. 13 Jackson

Mann Alfred, clerk, 9 South av. boards do.
MANN A. S. & CO. dry goods, 17 State.—
See top of book
 Mann Charles E. hostler, Roch. Driving park,
 boards 274 State
 Mann Charles N. carpenter, h. 27 Clifford
 Mann Elbert B. boards 31 South Clinton
 Mann Frank F. removed to Bath, N. Y.
 Mann George A. stables, 309 State, b. 274 do.
 Mann G. Edward, groom, 309 State, boards
 274 do.
 Mann Herman, collector, h. 69 Franklin
 Mann John, laborer, house 127 S. St. Paul
 Mann Kenneth S. millinery, 222 State, h. do.
 Mann Mary Mrs. stitcher, b. 62 West avenue
 Mann Nathaniel, locksmith, 29 S. St. Paul,
 house 3 Scrantom
 Mann Newton M. pastor, Unitarian Congre-
 gational Society, house 73 Meigs
 Mann Parker, student, b. 67 Plymouth av.
 Mann Thomas, harnessmaker, b. 9 South av.
 Mannel Gustavus, druggist, 31 Front, and
 president Roch. Brewing Co., house 119
 Alexander [Alexander]
 Mannel Henry, clerk, 31 Front, boards 119
 Mannes Christian, saloon, 126 South av. h. do.
 Manney Thomas, laborer, boards 5 Hunter
 Mannigan Michael, canvasser, bds. 56 Front
 Manning Charles E. ins. agent, 122 Powers'
 bldgs. boards 39 North York [do.]
 Manning Joseph, physician, 196 Brown, h.
 Manning Patrick M. moulder, 20 Court, bds.
 38 Front [h. 212 N. St. Paul
 Manning Thomas, grinder, Mill cor. Platt,
 Manning Thos. J. coachman, 12 S. Washing-
 ton, boards do.
 Manning Wm. (*Manning & Gibbard*), 122
 Powers' bldgs. house 39 North York
 Manning William C. engineer, h. 10 Orange
 Manning & Gibbard (*Wm. Manning and I.*
Gibbard), ins. agents, 122 Powers' bldgs.
 Mannix Amelia, widow, house 44 Broadway
 Manor Frank, clerk, 94 East av. boards 22
 Monroe avenue [37 Lancaster
 Manseau Anthony E. shoemaker, 1 Mill, h.
 Manser James, lastmaker, Shawmut bldg.
 house 137 South avenue
 Mansfield James, laborer, house r. 1 George
 Mansfield James jr. driver, 41 East Main, b.
 rear 1 George
 Mansfield John, laborer, h. r. 37 Monroe av.
 Mansfield Orrin, boards 45 Emerson
 Mansing Garrett, sawyer, Jay. c. Erie canal,
 house 96 Jay
 Mansing Henry, laborer, house 131 Campbell
 Mansing Henry jr. sawyer, 133 N. Water, b.
 131 Campbell
 Mansing Hiram, gluer, house 35 Magne
 Manson Martin A. tallyman, Erie Railway
 freight depot, house 88 Bartlett
 Manton Catharine, widow, h. 23 St. Joseph
 Manton James, gasfitter, b. 23 St. Joseph
 Manton Theresa M. milliner, b. 23 St. Joseph
 Manvel Edith L. teacher, Riley School, No.
 14, b. 133 University avenue
 Manvel Emily, teacher, Riley School, No.
 14, house 44 Meigs
 Manvel Garry, carpenter, house 44 Meigs

Manvel Livia A. teacher, Monroe School,
 No. 15, boards 44 Meigs
 Manzeg Albert, laborer, house 73 St. Joseph
 Manzeg Charles, laborer, h. Clifford c. Maria
 Manzeg Wm. laborer, boards 2 Thomas
 Manzer Jacob T. fireman, h. 102 Hudson
 Manzler Herman, laborer, house 65 Sanford
 Mapes A. tinsmith, 90 East Main [do.
 Mapes Clara J. Mrs. dressmaker, 44 Kent, h.
 Mapes Elias, machinist, Brown's race near
 Furnace, house 44 Kent
 Mapes Mary Miss, dressmaker, 44 Kent, b. do.
 Mapes Nathaniel, tinsmith, house 9½ Orange
 Mapes Sidney, boatman, b. 218 West Main
 Marburger Jacob, brewer, 106 N. Clinton,
 house do. [Stillson
 Marburger Margaret Mrs. midwife, house 21
 Marburger Yost, house 21 Stillson
 Marcella Sister, teacher, b. Jay cor. Frank
 Marchand Francis, machinist, house 42 Scio
 Marek Adam, blacksmith, 159 State, h. 17
 Hawkins [Genesee
 Marcille Daniel E. A. lime deliverer, b. 102
 Marcille Eliza A. house 102 Genesee
 Marcille Henri, stonecutter, h. 102 Genesee
 Marcille Henri Bruce, lime, b. 102 Genesee
 Marcille Philip P. M. carpenter, boards 102
 Genesee [avenue
 Marcotte Elizabeth, widow, h. 195 Monroe
 Marcy Lemuel, student, boards 11 Oregon
 Marden Jas. & Co. (*C. Covell*), baking pow-
 der, 85 Front, house 13 Goodman
 Marden Mary M. widow, bds. 13 Goodman
 Mardon W. Henry, carpenter, h. 41 Tremont
 Margrander Frederica, widow, b. 75 Hudson
 Margrander Frederick, laborer, house 158
 North av. [Holland
 Margrander Geo. J. laborer, 215 State, b. 16
 Margrander Jacob (*Goss & Margrander*), 53
 State, house 75 Hudson
 Margrander Lewis, boards 75 Hudson
 Maring Effie A. dressmaker, b. 55 Savannah
 Marion Edward T. removed from city
MARION FRANK H. hats, caps, furs,
 &c., 58 State, h. Park av.—*See page 538*
 Marion James, removed to Chili
 Markard John A. tailor, house North av. n.
 Clifford [Paul, h. Mary n. Clifford
 Markel John, marble polisher, 122 S. St.
 Markel Valentine, salesman, 102 Exchange,
 house 88 North avenue
 Markell Wm. L. bookkeeper, 205 Plymouth
 avenue, house 135 do. [92 South av.
 Markes William, shoemaker, 83 N. Water, h.
 Markie Jacob, janitor, house 31 Sanford
 Marks Elizabeth, widow, house 31 Ward
 Marks Francis W. news agent, 103 Mill, bds.
 31 Ward [State, h. 35 Ambrose
 Marks Henry D. photograph materials, 14
 Marks Hugh, grocer, 98 North St. Paul, h.
 40 Hand [Atwater
 Marks Jacob S. agent, 74 Mill, boards 55
 Marks John R. chairmaker, 15 Warehouse,
 house 96 Frank [Atwater
 Marks Lewis S. bookkeeper, 36 Mill, bds. 55
 Marks Morris, cutter, 72 Mill, b. 55 Atwater
 Marks Simon, salesman, house 55 Atwater
 Marks, see Marx and Markes

Marlatt Anna G. stitcher, boards 68 Oak
 Marlatt Harvey, laborer, boards 68 Oak
 Mariatt Maria, widow, house 68 Oak
 Marlett Richard, boards 47 North avenue
 Marling Vincent, telegrapher, 34 Arcade, b. 142½ West Main
 Marr John, insurance adjuster, h. 35 East av.
 Marrison Michael, mason, Brown cor. Jones, house 63 Magne
 Marriott Edward W. removed to Syracuse
 Marriott James H. weaver, boards 9 Lyell
 Marriott Joseph, carpetweaver, 9 Lyell, h. do.
 Marron John, blacksmith, 161 Lake avenue, house Straub alley near McCracken
 Marsden Wilham, overseer, Roch. Cotton Mill, house 63 Thompson near Costar
 Marsellus Henry W. agricultural tools, 151 West Main, boards 146½ do.
 Marsellus Wm. S. house 16 Greig
 Marsh Alfred, teamster, 77 Magne, house do.
 Marsh Edwin A. jeweler, house 8 N. Frances
 Marsh Edwin T. druggist, 90 Plymouth av. house do. [7, boards 144 Lake avenue
 Marsh Emma, teacher, Glenwood school No.
 Marsh Franklin A. salesman, 33 State, house at Holley [67 North
 Marsh James H. hairdresser, 5 Arcade, bds.
 Marsh James J. hairdresser, 5 Arcade, house 67 North avenue [147 do.
 Marsh John, shoemaker, 127 S. St. Paul, b.
 Marsh Laura E. widow, house 22 Broadway
 Marsh Margaret A. widow, h. 97 Fitzhugh
 Marsh May, teacher, Franklin school No. 6, boards 144 Lake avenue
 Marsh Seth W. foreman, h. 144 Lake avenue
 Marsh William, boards 147 South St. Paul
 Marsh Wm. laborer, boards 111 Frank
 Marshall Almon, laborer, h. 128 Lake avenue
 Marshall Charles, clerk, 75 E. Main, house 84 Broadway [Klinck n. Monroe av.
 Marshall Charles S. newspaper dealer, house
 Marshall Daniel, gardener, House of Refuge, house Lake avenue near tollgate
 Marshall David, h. Rapids road n. Genesee
 Marshall Elizabeth, widow, bds. Vick park
 Marshall Ella Miss, house 64 Asylum
 Marshall Francis H. bookbinder, house 107 West avenue [duct, b. 107 West av.
 Marshall Francis H. jr. bookbinder, 1 Aque-
 Marshall George, removed to Cleveland, O.
 Marshall James E. bookbinder, 1 Aqueduct, house 34 Trowbridge
 Marshall Louise, widow, bds. 45 South Ford
 Marshall Margaret, sewer, bds. 52 North av.
 Marshall Margaret B. teacher, 128 Plymouth avenue, house do.
 Marshall Mary M. widow, house 73 Fitzhugh
 Marshall M. Mead, bookbinder, h. Bay near Ackerman
 Marshall Simon, removed to Parma
 Marshall S. Eugene, salesman, 109 State, h. 87 Monroe avenue [av. b. 20 Greig
 Marshallsay Edward, butcher, 132 Plymouth
 Marsielje Abraham (*DeJonge & Marsielje*), 34 Buchan park, house do.
 Marsielje Delbert, mason, b. 34 Buchan park
 Marsielje John, laborer, h. 290 St. Joseph
 Marsielje Peter, house 18 Buchan park

Marsielje Peter jr. lastmaker, Shawmut bldgs. house 18 Buchan park
 Marsland Mary Mrs. house 23 Hickory
 Marsion Charlotte Mrs. house 237 Exchange
MARSON WILLIAM H. carpenter and builder, 5 Spring, boards 235 Exchange. —See page 634 [N. Clinton
 Martell Augustine, shoemaker, 15 Mill, b. 16
 Martell Peter, laborer, h. r. Stone n. Allen's al.
 Martell Philip, painter, boards 18 Joiner
 Martens Henry A. cigarmaker, 56 Martin, house do. [house 90 Weld
 Martens John, taxidermist, 4 College avenue,
 Martens William G. jeweler, 16 Elwood bl. house 5 Catharine
 Martin Abraham, boards 12 Delevan
 Martin Anthony H. grocer, Lyell cor. Childs, house Lyell opp. Cameron
 Martin Bernard F. (*Martin & Taylor*), b. 21 N. St. Paul cor. Mortimer
 Martin Catharine, widow, h. 154 St. Joseph
 Martin Chas. A. clerk, 122 Mill, b. 244 State
 Martin Charles F. deceased March 13, 1876
 Martin Charles J. hostler, 15 Fitzhugh, bds. Wimble House [house 142 W. Maple
 Martin Conrad, stonecutter, 22 West avenue,
 Martin C. A. Burr, clerk, Goodman c. rail- road, boards 26 Chatham [North av.
 Martin David, miller, Model Mills, house 42½
 Martin David F. clerk, 175 E. Main, house 71 Tappan
 Martin Elizabeth, stitcher, house 20 Cliff
 Martin Elizabeth, widow, h. 2 Madison park
 Martin Elizabeth J. widow, b. 21 Vick park
 Martin Ellen, widow, house 27 Scio
 Martin Ellen, widow, house 17 Line
 Martin Eva B. widow, house Hague n. R. R.
 Martin Ezra S. bookkeeper, bds. 71 Tappan
 Martin Francis H. turner, 3 Aqueduct, h. 145 Wilder [bds. 23 South Ford
 Martin George H. moulder, 106 S. St. Paul,
 Martin George W. drover, house 175 Jay
 Martin Henry, machinist, 100 S. St. Paul, h. West Maple near Ames
 Martin Henry C. millwright, h. 29 Magne
 Martin Hosea (*J. W. Martin & Bro.*), 59 State, boards 84 West avenue
 Martin James, fireman, h. 35 North avenue
 Martin James, house 19 Mathews
 Martin James B. cutter, 76 Mill, h. 49 Martin
 Martin James W. laborer, 22 West av, bds. 4 North Ford [Dover
 Martin Jay B. bootpacker, 55 Mill, house 14
 Martin John, laborer, boards Fulton av. cor. Brisbane
 Martin John, quarryman, h. 164 Champlain
 Martin John jr. carpenter, b. 164 Champlain
 Martin John C. grocer, E. Maple cor. North Frances, house do.
 Martin John H. machinist, boards 17 Lime
 Martin John H. hackman, boards 102 Mill
 Martin John M. shoemaker, 111 State, bds. 35 North St. Paul [Magnolia
 Martin John W. farmer, boards Genesee near
MARTIN JOHN W. & BRO. (*H. Martin*), pianos, 59 State, bds. 100 West av. —See page 524 [Brown
 Martin Joseph, sausage maker, b. Frances cor.

- Martin Leonard, deceased July 30, 1875
 Martin Levi, nickel plater, 122 Mill, house 244 State
 Martin Lewis P. brakeman, b. 2 Madison pk.
 Martin Margaret, boards 58 Reynolds
 Martin Mark, messenger, Kent corner Platt, house 140 Adams
 Martin Mary, widow, house 17 Orange
 Martin Mary, widow, house 13 Green
 Martin Mary, widow, house 13 Cobb
 Martin Michael, farmer, house Genesee near Magnolia
 Martin Millie, stitcher, boards 24 Scio
 Martin Nehemiah C. engineer, h. 46 Scio
 Martin Nellie Miss, clerk, 124 West Main, b. Genesee near Magnolia
 Martin Nicholas, turner, house 41 Gregory
 Martin Patrick, laborer, house 89 Cady
 Martin Paul H. painter, house Saxton near West Maple
 Martin Peter, cabinetmaker, house 65 Weld
 Martin Peter, blacksmith, 35 South St. Paul, house Borchard near N. Clinton
 Martin Phebe, widow, boards 24 Edward
 Martin Robert, carriagemaker, 9 Ely, boards 42½ North avenue
 Martin Robert M. student, Roch. Theological Seminary, boards Trevor Hall
 Martin Rosanna Miss, packer, b. 58 Reynolds
 Martin Salva B. widow, boards 44 Troup
 Martin Samuel, laborer, 7 S. St. Paul, house 2 Allen's alley
 Martin Sarah Mrs. widow, h. 46 Franklin
 Martin Stephen, confectioner, 70 Front, h. do.
 Martin Thomas, deceased Oct. 29, 1875
 Martin Thomas jr. machinist, bds. 17 Lime
 Martin Thomas E. sawyer, 22 West avenue, boards 4 North Ford
 Martin Wm. (*Spaulding & Martin*), 114 Plymouth avenue, boards 4 Edinburgh
 Martin William F. moulding maker, 13 Warehouse, house Hague near W. Maple
 Martin Zachariah, student, Rochester Theological Seminary, boards Trevor Hall
 Martin & Taylor (*B. F. Martin and G. W. Taylor*), house furnishing goods, 68 State
 Martin, see Martens and Mertin
 Martindale John H. (*Martindale & Oliver*), house West avenue cor. Chili road
 Martindale & Oliver (*J. H. Martindale and W. S. Oliver*), lawyers, 42 Powers' bldgs.
 Marts William, grocer, 38 Smith, house do.
 Martyn B. Franklin, carriagemaker, 3 Canal, boards 25 Clifton [bds. 25 Clifton
 Martyn John W. carriage maker, 3 Canal,
 Martyn Susannah, widow, bds. 25 Clifton
 Marvin David D. carpenter, 43 State, house 106½ West Main
 Marvin Luke, house 22 Favor
 Marx John cutter, 25 Mill, house 79 South av.
 Marx John J. blacksmith, h. 75 West Maple
 Marx Matthias, wagonmaker, Favor n. West av. house 55 Orange [bds. 55 Orange
 Marx Matthias jr. turner, 111½ North Water,
 Marx Nicholas, deceased Feb. 5, 1876
 Marx Peter, carriagemaker, h. 7 Tonawanda
 Marzahl Charles, tailor, 10 W. Main, house 9 Catharine
 Marzluff Ferry F. detective, City Hall, house 72 Sanford
 Marzluff Frederick, shoemaker, b. 67 Munger
 Marzluff John, boatbuilder, bds. 67 Munger
 Marzluff John B. salesman, 17 State, house 158 Pinnacle avenue
 Maser Charlotte, widow, house 83 Cady
 Maser John W. (*Rothgungal & Co.*), Erie canal near Klinck, house 28 Broadway
 Maser Martin, cartman, 6 S. St. Paul, h. 8 Cobb
 Maslin William, shoemaker, h. 13 Brisbane
 Mason Amanda, carpet weaver, h. 43 Platt
 Mason Ann Mrs. fancy goods, 30 Bolivar, house do. [ston pl. cor. Troup
 Mason Caleb H. 55 Powers' bldgs. b. Living-Mason Catharine Mrs. house 92 Exchange
 Mason Charles P. boards 134 South St. Paul
 Mason Chloe, clerk, boards 2 Perkins
 Mason Elizabeth A. Miss, house 34 Chestnut
 Mason Fletcher W. fireman, b. 3 Plymouth av.
 Mason Frank B. boards 47 Lake avenue
 Mason George, teamster, Roch. Driving Park, house Eleventh near Rowe
 Mason Geo. A. removed to Albany
 Mason George W. agent, house 9 Montrose
 Mason James, shoemaker, bds. 75 Exchange
 Mason John, cooper, house 109 West Maple
 Mason John C. stables, 279 State, house 47 Lake avenue
 Mason John H. health inspector, h. 7 Jones
 Mason John H. student, Roch. Theological Seminary, boards Trevor Hall
 Mason John L. hostler, house 9 N. Clinton
 Mason J. Calvin (*Goodwin & Mason*), house 122 Lake avenue
 Mason Louis, driver, house 152 Plymouth av.
 Mason Melancthon W. deceased June, 1875
 Mason Minerva, laundress, boards 23 Jay
 Mason M. W. Mrs. widow, h. 114 Lake av.
 Mason Persis, widow, house 2 Perkins
 Mason Ruth, widow, boards 34 Chestnut
 Mason Thomas, gas fitter, Gas Works, house 9 Kent alley
 Mason William, carpenter, Franklin corner North avenue, house 31 Lancaster
 Mason William J. grinder, h. 60 W. Maple
MASSETH FRANK X. livery stable, 15 Fitchugh, house do.—*See page 606*
 Masseth George, stable, 171 State, h. 125 do.
 Massey Matthew, foreman, foot of Centre, house 38½ Hunter [Phelps av.
 Masten Cornelius S. civil engineer, house 30
 Masten George P. clerk, Whitcomb House, 224½ East Main
 Masten M. Emma, widow, house 8 Chestnut
 Masters Alfred J. silver gilder, 38 Gorham, house 53 Oakman
 Masters Charles F. printer, bds. 53 Oakman
 Masters Julius, engineer, Erie railway, house 179 Exchange
 Masterson Johanna, widow, house 7 Swan
 Masterson John J. cabinetmaker, house 174 North St. Paul
 Masterson Nellie Mrs. 75 Tappan
 Masterton Wm. R. painter, b. 42 Manhattan
 Matheis Peter, moulder, 8 Hill, h. 384 Brown
 Mather Sarah C. widow, house 7 Greenwood avenue

Mather William B. overseer, House of Refuge, boards do.
 Mathes Philip, mason, house 14 Delavan
 Matheson Henry, coachman, Osburn House
 Mathews Amelia C. boards 20½ Hamilton pl.
 Mathews Bridget M. widow, h. 1 Woodbury
 Mathews Caroline L. Mrs. h. 212 Alexander
 Mathews Catharine E. Mrs. house 28 Spring
 Mathews Charles A. discount clerk, Traders' National Bank, 35 W. Main, b. 56 Sophia
 Mathews Frank J. shoemaker, 91 North Water, boards York House [12 East
 Mathews George, bookkeeper, 44 State, bds.
 Mathews Henry W. book keeper, Water works, City Hall, boards 28 Spring
 Mathews J. Sims, lawyer, 109 Arcade, house 114 State
 Mathews Mary, widow, house 318 State
 Mathews Mary E. dressmaker, bds. 87 Lyell
 Mathews Patrick, grocer, 89 Lyell, h. 87 do.
 Mathews Richard, laborer, bds. 20 Sophia
 Mathews Robert (*Hamilton & Mathews*), 21 West Main, boards 28 Spring
 Mathews W. Henry, prest. Rochester Printing Co. 3 West Main, house 12 East
 Mathewson Andrew J. grocer, 17 Monroe av. house 15½ do. [15½ do.
 Mathewson Kittie, clerk, 17 Monroe av. bds.
 Mathis Joseph (*Mathis & Neuhart*), house 227 East Main
 Mathis & Neuhart (*Joseph Mathis and Emil Neuhart*), bottle manufs. 229 East Main
 Mathony Jacob, tailor, 71 Joiner, house 263 North Clinton [16 Jackson
 Mattai Romeo, plasterer, 9 Andrews, house
 Mattern Charles, laborer, house 4 Clifford
 Mattern George, tailor, boards 4 Clifford
 Mattern George (*Zwoerger & Mattern*), Clifford near North Clinton, house 19 Hoelfer
 Mattern Jacob G. shoemaker, 73 N. Water, house 9 Flower [b. 31 Walnut
 Mattern Joseph, cabinetmaker, 22 S. St. Paul,
 Mattern Marcus, cabinetmaker, 133 North Water, boards 31 Walnut
 Matteson James N. painter, h. 3 Harris av.
 Matteson Judiah H. removed to Buffalo
 Matteson Sally A. house 257 North St. Paul
 Matthews Alfred, painter, 74 Arcade, boards 29 Comfort
 Matthews Catharine, widow, house 67 Hunter
 Matthews Charles H. (*J. M. Pitkin & Co.*), 75 East avenue, house 61 Meigs
 Matthews Emma M. teacher, Seward School, No. 19, boards 67 Hunter
 Matthews James (*Matthews & Servis*), liquors, 86 West Main, house 20 Sophia
 Matthews John, plasterer, house 29 Comfort
 Matthews John S. mason, h. 11 Whitmore pk.
 Matthews Oliver, carpenter, boards 106 Jay
 Matthews William, carpenter, 106 Jay, h. do.
 Matthews & Servis (*J. Matthews and S. A. Servis*), liquors and cigars, 86 W. Main
 Mattison George L. copyist, h. 75 Frances
 Mattle Bartholomew, agent, house N. Clinton near Norton
 Mattle Catharine, widow, boards 100 Ames
 Matzig Joseph A. carpenter, house Munger near Whalin

Mauder Alise, carpenter, bds. 33 Oakman
MAUDER FREDERICK J. carpenter and contractor, Oakman corner Galusha, h. do.—*See page 633*
MAUDER JOHN, mason and contractor, house 271 N. Clinton.—*See page 640*
 Mauder John, laborer, house Oakman cor. Hawkins [5 Woodbury
 Maurer Charles H. market, 130 Hudson, h.
 Maurer Charles N. carpenter, h. r. 11 Childs
 Maurer Edward W. student, University of Rochester, boards 30 N. Clinton
MAURER GEORGE C. merchant and foreign agent, 78 East Main, house 30 N. Clinton.—*See page 595*
 Maurer George J. clerk, 78 East Main, bds. 30 North Clinton
 Maurer Jacob, cooper, house 12 Tonawanda
 Maurer Jacob, engineer, house 173 Brown
 Maurer Jacob G. clerk, Post Office, house 17 William
 Maurer Sophia, widow, house 16 Tonawanda
 Maurer Theodore F. boards 30 N. Clinton
 Maurer William, cartman, house 12 Rhine
 Maurer William, carpenter, house 79 Kelly
 Maurer Joseph, laborer, Atwater cor. North Water, house North York cor. R. R.
 Maurhofer Annie, widow, boards 32 Thomas
 Maurhofer Jacob, tailor, house 32 Thomas
 Mausnest Conrad, printer, 23 West Main, b. 133 Hudson [Hudson
 Mausnest George, clerk, 53 North av. b. 133
 Mausnest Leonard, blacksmith, 133 Hudson, house do.
 Maw Eli, coachman, Monroe avenue near Boardman, house Monroe av. near canal
 Maxfield Charles A. trimmer, 87 Exchange, b. 69 Mt. Hope av. [Hope av.
 Maxfield Sarah M. physician, house 69 Mt.
 Maxon Frank W. printer, boards 10 Eagle
 Maxon George L. mason, h. 10 Tremont pl.
MAXON GEORGE L. mason and contractor, house 10 Tremont pl.—*See page 634*
 Maxon Benjamin, mason, house McCracken corner First
 Maxson B. Frank (*Maxson & Simons*), 119 Powers' bldgs. house 20 East avenue
 Maxson Willard J. mason, house 10 Eagle
 Maxson & Simons (*B. F. Maxson and J. C. Simons*), lawyers, 119 Powers' bldgs.
 Maxwell Elizabeth, b. East av. c. Alexander
 Maxwell George, laborer, h. Sherman n. Otis
 Maxwell James, student, boards 62 Griffith
 Maxwell James A. (*Walbridge & Maxwell*), State cor. Railroad avenue, bds. do.
 Maxwell John (*Maxwell, Newman, McMannis & Co.*), house 62 Griffith
MAXWELL, NEWMAN, McMANNIS & CO. (*J. Maxwell, C. H. Newman, and J. T. McMannis*), casket manufs. 22 South St. Paul.—*See page 578*
 Maxwell John (*Williams & Co.*), 46 Exchange, house at Malden, N. Y.
 Maxwell Thomas S., Weed sewing machines, 18 East Main, house 21 Swan [do.
 May Adam, grocer, W. Maple c. Childs, h.
 May Alfred E. baker, boards 25 North av.
 May Barbara, widow, b. Colvin c. Campbell

HENRY C. WISNER,

MAJOLICA, KIWOTA AND JAPANESE CHINA,
 No. 33 STATE STREET.

- May Charles, painter, house 1 Unity
 May Charles, carpenter, boards 14 Morris
MAY EDWARD B. general European book agent, 45 E. Main, house 25 North avenue.—See page 593
 May Frank N. grocer, Colvin corner Campbell, house do. [house do.
 May Gustave, grocer, Reynolds c. Bartlett,
MAY HORACE, lime manufacturer, 90 S. St. Paul, house at Allen's Creek.—See page 658
 May John J. laborer, b. Hudson n. Bernard
 May Joseph, carpenter, house 297 N. Clinton
 May Lorenzo, house 14 Morris
 May Martin, grocer, 82 Maple c. York, h. do.
 May Michael, tailor, 200 N. Clinton, boards 14 Morris
 May Walter, student, bds. 25 North avenue
 Mayer August, painter, h. Concord avenue cor. Channing [boards do.
 Mayer Conrad, baggageman, Osburn House,
 Mayer David, laborer, house 82 Pinnacle av.
 Mayer Donat, machinist, Brown's race near Furnace, house Hollister cor. Lansing
 Mayer Elizabeth, widow, boards 93 Scio
 Mayer Frederick, baker, 45 Fitzhugh, house 93 Scio
 Mayer George (*Mayer & Suiler*), Cottage, h. do.
 Mayer John, blacksmith, house 65 Kelly
 Mayer John jr. scalemaker, boards 65 Kelly
 Mayer John, laborer, b. Hollenbeck near Norton [house 30 King
 Mayer John (*Hoffman & Mayer*), 10 Allen,
 Mayer John M. peddler, 110 Hudson, house 77 Herman
 Mayer Martin, removed to Buffalo
 Mayer Michael, mason, house 1 Mauder's pk.
 Mayer Theresa, saloon, 190 N. Clinton, h. do.
 Mayer Thomas, laborer, boards Goodman n. College avenue
 Mayer & Suiler (*G. Mayer and C. Suiler*), brewers, Cottage near Plymouth avenue
 Mayloy Edward C. sewing machine manuf. 57 State, house 194 Oak
 Mayloy Eliza, widow, boards 194 Oak
 Mayloy Helen, machine operator, b. 194 Oak
 Maynard Abigail, widow, house 3 James
 Maynard Guillermo B. removed to Albany
 Maynard Jesse S. shoemaker, 97 Lake av. house 66 Lorimer [2 Orange
 Maynard John B. miller, Flour City Mills, h.
 Maynard Pensia M. Mrs. house 80 Frank
 Maynard Ransom, deceased Feb. 11, 1876
 Maynard Scott W. packer, House of Refuge, boards 66 Lorimer [house 156 Lyell
 Maynard Theophilus, miller, Jefferson Mills,
 Maynard William, carpenter, bds. 3 James
 Mayo William G. silver plater, 31 Smith's block, boards 55 Caledonia avenue
 Mayock Patrick, flagman, Mill st. crossing, house 108 Whitney
 Mazheiser John, wiper, house 29 N. Frances
 Mazuret Adolphus, shoemaker, 124 Front, h. 32 Galusha
 Mazuret Alexander, stonecutter, b. 32 Galusha
 Mazuret Eugene, shoe cutter, 55 Mill, house 32 Galusha
 Mazuret Mary, tailoress, boards 32 Galusha
 Mazuret Matilda, tailoress, bds. 32 Galusha
 Mazuret Peter L. foreman, River cor. North Water, boards 32 Galusha
 McAlden George, clerk, 23 Exchange place, house 23 Buchan park
 McAleer Joseph, laborer, Brown corner Jones, house 98 Wilder
 McAllaster George (*Sunderlin & McAllaster*), 18 State, house 80½ Plymouth avenue
 McAllister Frank, moulder, Brown's race, n. Furnace, boards 332 State
 McAllister Mary Mrs. house 68 Savannah
 McAlpine Byron D. lawyer, 58 Arcade, house 113 Fitzhugh
 McAlroy Milton, removed to Chicago
 McAnally Charles, hackman, h. 22 N. Union
 McAnally Hattie, clerk, boards 80 North av.
 McAnally John H. clerk, 65 West Main
 McAnally Nicholas, tinsmith, 153 E. Main, house 14 Gardiner park
 McAnarney John H. bookkeeper, Exchange corner Court, boards 142 Brown
 McAnarney Thomas, grocer, 142 Brown, h. do.
 McArdle Bridget Mrs. house 66 Bolivar
 McArdle Bryan, cooper, 1 St. James park, house 66 Bolivar
 McArdle Patrick, laborer, house 15 Montrose
 McArdle Philip, salesman, boards 66 Bolivar
 McArthur Christina, sewer, b. 21 Savannah
 McArthur Daniel, carpenter, house 9 Adams
 McArthur Daniel jr. removed to Buffalo
 McArthur George, carpenter, boards 93 Jay
 McArthur Malcolm, teamster, h. 21 Savannah
 McArthur Mary Mrs. widow, b. 21 Savannah
 McArthur Wallace R. policeman, City Hall, house 9 Adams
 McAuliff John, car coupler, h. 10 Victoria
 McAuliffe Frances, widow, h. 62 West av.
 McAvinney Barney, laborer, house 5 Syke
 McAvinney Catharine, widow, h. r. 7 Walnut
 McBeth Wm. J. seedsman, 1 East park, house Union corner Charlotte
 McBeth Wm. J. jr. machinist, Court corner Stone, boards 49 Charlotte
 McBride Arthur J. engineer, h. 18 Comfort
 McBride Asa D. (*McBride & True*), h. 81 Scio
 McBride James, teamster, h. Sibley n. Bates
 McBride James H. bartender, Farmers' Hotel boards do.
 McBride Patrick, laborer, house Magnolia n. Genesee
 McBride & True (*A. D. McBride and C. W. True*), agricultural implements, 134 East Main
 McBrien Ann, stitcher, bds. 25 St. Joseph
 McBrien Bridget Miss, house 25 St. Joseph
 McBrien Catharine, stitcher, b. 25 St. Joseph
 McBrien Patrick D. car inspector, house 20 Leopold [h. 17 Conkey av.
 McBurney Ephraim W. policeman, City Hall,
 McBurney Harvey F. potter, house 35 Hamilton place
 McBurney Mary A. stitcher, boards 41 Davis
 McCabe Ann, widow, house Frank cor. Jay
 McCabe Bernard, deceased July, 1875
 McCabe Charles, laborer, 16 Stone, house Brown's alley near Lyell
 McCabe James, painter, house 2 Shamrock

- McCabe James, clerk, 37 State, boards 29
Plymouth avenue
- McCabe James, painter, 14 Stone, h. 29 Joiner
- McCabe John J. laborer, house 25 Cypress
- McCabe Joseph W. agent, 45 E. Main, bds.
State
- McCabe Margaret Mrs. house 19 Vincent pl.
- McCabe Mary, paster, boards 19 Vincent pl.
- McCabe Mary A. dressmaker, b. 53 West
avenue
- McCabe Owen E. grocer, 53 West av. h. do.
- McCabe Patrick, stonemason, 54 Fitzhugh,
boards 25 Cypress
- McCabe Sarah, straw sewer, boards 13 Jones
- McCaffrey Bernard, blacksmith, 22 West av.
house 3 James
- McCaffrey James, coachman, house Ames
- McCaffrey James, laborer, house 101 Tremont
- McCaffrey John, laborer, boards 205 State
- McCaffrey William, removed to Newark
- McCahill John, coachman, Temple n. Chest-
nut, house 1 James
- McCall Andrew, laborer, boards 68 Cypress
- McCall Bessie, widow, house r. 54 S. St. Paul
- McCall James B. salesman, 19 Mill, boards
at Gates [213 North
- McCall John, switchman, N. Y. C. R. R. b.
- McCall John H. railroad agent, 88 Mill, bds.
Brackett House
- McCall John J. (*Hampton & McCall*), 348
State, b. Lyell n. Whitney
- McCall Martha, dressmaker, 38½ Fitzhugh,
boards 13 Jones
- McCall Owen, switchman, h. Leighton av.
- McCall Patrick, switchman N. Y. C. R. R.
house 213 North [R. h. 215 North
- McCall Patrick 2d switchman, N. Y. C. R.
- McCall W. Wallace, salesman, 19 Warehouse,
house 36 Fulton avenue
- McCallister Esther, widow, house Costar n.
Saratoga avenue
- McCallister John R. carpenter, house Costar
near Saratoga av.
- McCallum Archibald, blacksmith, h. 2 Almira
- McCallum Maggie M. gilder, 38 Gorham, b.
2 Almira [L. I.
- McCallum Mary Mrs. removed to Brooklyn,
- McCallum Mary A. widow, h. 106½ W. Main
- McCandles Samuel, boards 15 Orchard
- McCann Hanora, widow, house 11 Green
- McCann Kate, forewoman, 42 State
- McCann Margaret, domestic, Osburn House
- McCanty Bridget J. widow, house 123 Jones
- McCanty Frank, machinist, bds. 123 Jones
- McCardle John, laborer, house 42 Brown's al.
- McCarn Sarah J. physician, 38 Lyell, h. do.
- McCartey Cornelia, widow, house 22 Grove
- McCartey Cornelia Miss, music teacher, bds.
22 Grove
- McCartey Frank, composer, h. 22 Grove
- McCarthy Abby, dressmaker, 2 Lowell, h. do.
- McCarthy Anna, widow, h. 126 North av.
- McCarthy Benj. hostler, b. 68 William
- McCarthy Bridget, widow, house 15 Rome
- McCarthy Bridget M. widow, h. 174 North
St. Paul
- McCarthy Catharine, widow, house 2 Lowell
- McCarthy Catharine M. Mrs. b. 25½ Oak
- McCarthy Charles, clerk, 164 State, b. do.
- McCarthy Charles, shoemaker, h 23 Munger
- McCarthy Charles H. bartender, 128 State,
boards 101 Mill
- McCarthy Daniel, yardman, Exchange cor.
Clarissa, b. 42 Frost av. [Falls
- McCarthy Dennis H. removed to Niagara
- McCarthy Elizabeth, widow, h. 53 William
- McCarthy Ellen, widow, house 8 Moore
- McCarthy Ellen, clerk, boards 1 Lorimer pl.
- McCarthy Florence, liquors, 128 State, bds.
Ayers's Hotel [h. 47½ Lowell
- McCarthy Florence D. expressman, 83 State,
- McCarthy James, laborer, h. 51 Brown block
- McCarthy James A. upholsterer, 88 State, b.
53 William
- McCarthy James J. cigar maker, 138 West
Main, h. Adams n. Reynolds
- McCarthy Jane, widow, house 68 William
- McCarthy John, laborer, boards Flint near
Frances
- McCarthy John, cigar manuf. 45 E. Main,
house 21 Hand [h. 2 Edinburgh
- McCarthy John, switchman, Erie R'y depot,
- McCarthy Margaret Mrs. widow, h. 108 Caledo-
nia avenue
- McCarthy Mary, dressmaker, bds. 27 Lake av.
- McCarthy Michael, fireman, Erie Railway,
boards 4 Edinburgh
- McCarthy Nelly, dressmaker, bds. 2 Lowell
- McCarthy Owen, teamster, 90 S. St. Paul,
house Field near Monroe avenue
- McCarthy Patrick, laborer, house 8 Vought
- McCarthy Peter, carpenter, 1 Lorimer place
- McCarthy Rosa, dressmaker, boards 8 Moore
- McCarthy Thomas, nurseryman, house Flint
near Frances [b. 60 Chestnut
- McCarthy Thomas F. salesman, 41 E. Main,
- McCarthy Florence, salesman, h. 25½ Oak
- McCarthy William, packer, 74 State, b. Oak
- McCarthy William, crockery, 41 E. Main, h.
60 Chestnut
- McCarthy William jr. clerk, 41 E. Main, b.
60 Chestnut
- McCarthy —, widow, 130 Fulton avenue
- McCartney James G. clerk, 16 Exchange,
b. 87 Fitzhugh
- McCart Ann, widow, house 156 Frank
- McCart Daniel, laborer, b. West. near Erie
canal [Perkins
- McCart Henry, pulp maker, Paper Mill, h.
- McCart Hugh, coupler, house Anderson av.
corner Railroad
- McCart James, laborer, boards 156 Frank
- McCart Patrick, laborer, boards 156 Frank
- McCart William, laborer, h. West n. canal
- McCAULEY JAMES F.** merchant tailor,
35 State, h. 20 East.—*See page 536*
- McCauley Lillie, stitcher, b. 221 E. Main
- McCauley Matthew, laborer, bds. 35 Jones
- McCauley Patrick, groom, 159 State, house
35 Jones
- McCauley Peter, laborer, boards 140 Jones
- McCauley Sarah Miss, house 246 State
- McCaw John, boiler maker, Platt n. Jones,
house 32 Lorimer
- McClain George, laborer, house 5 Meigs
- McClain James, removed to Greece

- McClain William, cigarmaker, 45 E. Main, house 236 State [Pinnacle av.]
- McClary George H. pattern maker, boards 8
- McClasky Isaac, filecutter, b. 69 St. Joseph
- McClasky Susan, widow, h. 69 St. Joseph
- McClelland Gawn, carpenter, Litchfield n. canal, house 38 Spencer
- McClelland Jennie E. dressmaker, boards 38 Spencer
- McClelland Wm. G. machinist, house 13
- McClennan Daniel J. salesman, 55 South St. Paul, boards Schleyer's block
- McCloy Daniel, peddler, 144 E. Main
- McClure Samuel, boards 27 N. St. Paul
- McCLUSKY JOHN**, market, 130 West Main, b. 5 N. Washington.—See page 553
- McClusky Thomas, saloon, 138 West Main, house 71 Adams
- McCoart Elizabeth, removed to Canada
- McCoart Jeremiah, boarding house, 14 Platt
- McComb D. Miss, tailoress, bds. 41 Hunter
- McComb William, cook, house 41 Hunter
- McConkey Margaret, bds. East avenue cor. Alexander [n. Canal, h. 65 Jay
- McConnell Alexander, carpenter, Litchfield
- McConnell Archibald B. contractor, house 77 Court
- McConnell Archie, clerk, boards 77 Court
- McConnell Charles H. agent, 126 State, bds. 165 West Main
- McConnell Charles H. barber, Reynolds near Adams, boards 88 Plymouth av.
- McConnell Eugene, foreman, b. 118 East av.
- McConnell John (*McConnell & Jones*), 50 Exchange, house 118 East avenue [b. do.
- McConnell Joseph L. clerk, 141 East Main,
- McConnell Philip, Plymouth Avenue House, 88 Plymouth av. h. do. [h. 85 Court
- McConnell Robert Y. (*McConnell & Pringle*),
- McConnell William, house 122 West avenue
- McCONNELL & JONES** (*J. McConnell and Wm. H. Jones*), street contractors, Exchange cor. Spring.—See page 657
- McConnell & Pringle (*R. Y. McConnell and G. Pringle*), street sprinklers, 107 South St. Paul
- McConvill Ann, widow, house 102 Cady
- McConvill Mary, tailoress, b. 16 Manhattan
- McCool Daniel, removed to Buffalo [place
- McCormick Alexander, boatman, h. Briggs'
- McCormick Ann, widow, boards 1 Ward
- McCormick Ann, widow, h. 47 Pinnacle av.
- McCormick Arthur, plasterer, h. 16 Fulton avenue [house do.]
- McCormick Catharine, grocer, 147 Lyell
- McCormick Charles, policeman, City Hall, house 32 Troup [Mt. Hope av.]
- McCormick Charlotte E. widow, boards 126
- McCormick Delia, widow, house 20 Griffith
- McCormick Dennis (*Dance & McCormick*), 328 State, house 16 Bolivar
- McCormick Edward, mason, bds. 308 State
- McCormick James, mason, boards 308 State
- McCormick Joanna Miss, finisher, bds. West Troup near Wall [sing, h. 15 Cameron
- McCormick John, flagman, Whitney st. cross
- McCormick John, melter, Brown's race near Furnace, house 4 Orange
- McCormick John, stonecutter, h. 176 W. Main
- McCormick John, laborer, house 76 Troup
- McCormick John, sashmaker, b. 15 Cameron
- McCormick John G. clerk, bds. 20 Griffith
- McCormick John H. clerk, 151 State, boards 16 N. Clinton
- McCormick Margaret, boards 16 Lyell
- McCormick Martin, laborer, Brown c. Jones, house 31 Thompson [av. h. do.]
- McCormick Mary, fancy goods, 30 Saratoga
- McCormick Michael M. coachman, 37 Spring, house 75 Broadway
- McCormick Owen, painter, b. 11 Elizabeth
- McCormick Patrick, saloon, Mill cor. Platt, house do. [atoga av.]
- McCormick Patrick, mason, house 30 Sar-
- McCormick Patrick, laborer, h. 20 Brisbane
- McCormick Rosanna, widow, h. 17 Costar
- McCormick Samuel, laborer, house Child's alley near Erie canal
- McCormick Thomas, painter, 10½ South St. Paul, boards Farmers' Hotel [ton, D.C.]
- McCormick Thomas, removed to Washing-
- McCourt Charles, stable, 1 Ely, house do.
- McCourt Hugh, watchman, h. 3 Grape
- McCoy Anthony, foreman, house 13 Hill
- McCoy Charles B. brass moulder, house 32 South Ford [32 S. Ford
- McCoy Charles F. pressman, 3 West Main, b. 62
- McCoy Francis (*McCoy & Fabling*), house 62 Asylum [n. S. Ford
- McCoy James H. shoecutter, h. Waverley pl.
- McCoy John, tobacconist, 23 West Main, b. 14 Lowell
- McCoy John H. shoemaker, 5 Stone, h. do.
- McCoy Sophia, dressmaker, h. 44 Sanford
- McCoy & Fabling (*F. McCoy and S. Fabling*), carpenters, 3 North avenue
- McCracken Anna, widow, house 54 Frank
- McCracken James B. removed from city
- McCracken Patrick J. laborer, 5 Aqueduct, boards 54 Frank
- McCracken Robert, tanner, b. 39 North av.
- McCracken Thomas F. blacksmith, house 54 Frank
- McCrehon Alexander, removed from city
- McCrehon Anna Miss, tailoress, b. 7 Foehner
- McCrehon Bridget, widow, house 7 Foehner
- McCrossen Ransom D. agent, 53 East Main, house 50 Frances
- McCruden John, tailor, h. 230 Plymouth av.
- McCue Ann, widow, house 44 Front
- McCue Patrick, laborer, 1 Green
- McCullan Thomas, laborer, h. 150 Hunter
- McCullan Thomas jr. shoemaker, boards 150 Hunter
- McCullen Bridget, widow, house 246 State
- McCullen Mary E. Mrs. saloon, 220 State, house do.
- McCullen Patrick, shoemaker, b. 150 Hunter
- McCullin James, cigar maker, 3 South St. Paul, boards 246 State
- McCulloch George A. cooper, 1 St. James park, boards 13 Syke
- McCulloch Henry, laborer, b. 134 N. St. Paul
- McCulloch James, cooper, 30 Canal, house 13 Syke
- McCulloch James jr. shoemaker, b. 13 Syke

McCulloch John, tanner, h. 134 N. St. Paul
 McCulloch Nathaniel, thermometer maker,
 house 2 Saratoga avenue
 McCulloch Thomas, laborer, b. 134 N. St. Paul
 McCullough James H. porter, 54 Mill, boards
 30 Ward
 McCullough Hugh, truckman, h. 84 Atkinson
 McCullough John, shipper, 22 E. Main, bds.
 14 Ward
 McCullough Robert, clerk, b. 84 Atkinson
 McCullough William, cutter, 55 Mill, boards
 84 Atkinson
 McCurdy Hugh, laborer, house 86 Clifton
 McCusker Margaret, cotton weaver, boards
 rear 1 Smith
 McCusker Michael, cooper, house 13 Spencer
 McCusker Rosa, widow, house 1 Smith [al.
 McCusker Thomas, laborer, house 11 Brown's
 McCutchen John, machinist, 108 State, house
 11 Fitzhugh
 McCutchen Robert, shoemaker, house 2 Bloss
 McDade Andrew, grocer, 346 State, house 65
 Lake avenue
 McDermott Ann, house 122 Fulton avenue
 McDermott Catharine, widow, h. 13 Marietta
 McDermott George E. laborer, boards 172
 North St. Paul
 McDermott James E. house 8 Galusha
 McDermott John E. watchman, City Hall,
 house 65 Manhattan
 McDermott John H. jr. painter, b. 14 Ward
 McDermott John H. blacksmith, h. 14 Ward
 McDermott John J. P. machinist, b. 9 Charles
 McDermott Joseph, cooper, Butler c. Charles,
 boards 9 Charles [n. Poplar
 McDermott Joseph E. nurseryman, h. Sanford
 McDermott Mary, widow, boards 15 Martin
 McDermott Mary A. widow, house 8 Galusha
 McDermott Otis, boards 8 Galusha
 McDermott Patrick, hostler, h. 172 N. St. Paul
 McDermott Patrick A. boards 122 Fulton av.
 McDermott Thomas, cigar manuf. 22 S. St.
 Paul, boards 65 Manhattan [hattan
 McDermott Timothy, laborer, house 65 Man-
 McDermott William, laborer, h. 9 Charles
 McDermott Wm. E. rem'd to Portland, Or.
 McDiarmid Archibald, student, Roch. Theol-
 ological Seminary, boards Trevor Hall
 McDonald Alexander, salesman, 24 State,
 boards 15 Chestnut park [n. Rowe
 McDonald Alexander, carpenter, h. Fourth
 McDonald Angus (McDonald & Raines), h.
 Goodman near University avenue
 McDonald Angus, 79 State, b. 170½ W. Main
 McDonald Ann, boards Goodman near Uni-
 versity avenue [State
 McDonald Anna M. Mrs. dressmaker, h. 156
 McDonald Arthur, student, boards Goodman
 near University avenue
 McDonald Barney, removed to Geneva
 McDonald Carrie, domestic, b. 13 Mortimer
 McDonald Charles, salesman, 53 E. Main, h.
 116 Tremont [S. St. Paul
 McDonald Colin, miller, 3 N. Water, h. 128
 McDonald Cornelius, grocer, 2 Lake av. h. do.
 McDonald Cynthia, boarding house, 340
 State, house do.
 McDonald Edward, laborer, b. 216 N. St. Paul

McDonald Edward J. clerk, 2 Lake av. b. do.
 McDonald Eliza Miss, h. 30 McDonald av.
 McDonald Frank, jeweller, 88 Powers' bldgs.
 boards 14 Pearl
 McDonald Henry, laborer, bds. 15 Emmett
 McDonald Hugh H. butcher, h. 13 W. Troup
 McDonald James, moulder, house 153 Frank
 McDonald James H. shoemaker, 81 North
 Water, house 19 Hudson
 McDonald Jane, widow, house 14 Pearl
 McDonald John, engineer, N. Y. C. R. R.
 house 75 Jay
 McDonald John, laborer, b. 119 N. St. Paul
 McDonald John, shoemaker, 14 State, house
 70 Hunter [b. 70 Hunter
 McDonald John jr. shoemaker, 6 N. Water,
 McDonald John, deceased Dec. 19, 1875
 McDonald Joseph (Bastable & McDonald), b.
 158 Brown
 McDonald Joseph, removed to Cleveland, O.
 McDonald Kezia Miss, house 150 Alexander
 McDonald Lock, coachmaker, 3 Canal, h.
 36 Prospect [ander
 McDonald Maggie, domestic, bds. 106 Alex-
 McDonald Margaret, stitcher, boards 7 John
 McDonald Martin, clerk, 140 West Main, h.
 27 Hunter
 McDonald Mary, widow, house 15 Emmett
 McDonald Patrick, shoemaker, 87 N. Water,
 boards 15 Emmett [2 Lake av.
 McDonald Patrick, shoemaker, 4 Allen, bds.
 McDonald Patrick H. salesman, 53 E. Main,
 b. 28 Chatham [Hotel, h. 131 Adams
 McDonald Rolland R. bartender, National
 McDonald William, clerk, boards 14 Pearl
 McDonald William, boards 28 Chatham
 McDonald William, dept. warden, Monroe
 Co. Insane Asylum, b. do. [Hunter
 McDonald William, stove moulder, bds. 27
 McDonald William H. hairdresser, 34 Ex-
 change, house 167 W. Main
 McDonald & Raines (Angus McDonald and
 George Raines), lawyers, 1 Court House
 McDonnell James & Co. (H. Gallagher),
 clothing, 24 State, house East avenue
 near Goodman [do.
 McDonnell Jane, dressmaker, 3 N. Ford, b.
 McDonnell Mary E. domestic, 5 Oak
 McDonough Dora, stitcher, b. rear 342 State
 McDonough Edward, policeman, City Hall,
 boards 96 S. St. Paul [h. 50 Chatham
 McDonough Edward, tailor, 65 Smith's blk.
 McDonough John, removed to Geneva
MCDONOUGH JOHN H. carriage manuf.
 Mortimer corner North Water, house 50
 Franklin.—See page 606
 McDonough John W. barkeeper, 9 Exchange,
 b. 50 Chatham [change, h. 80 do.
 McDonough Patrick H. barkeeper, 9 Ex-
 McDowell Alexander, laborer, bds. 35 Tyler
 McDowell Alvina, widow, house 35 Tyler
 McDowell Andrew, horse trainer, Rochester
 Driving Park, h. McCracken n. Lake av.
 McDowell Charles I. lawyer, 31 State, house
 28 Ambrose
 McDowell Edward, laborer, boards 35 Tyler
 McDowell Hugh (McDowell & Co.), bds. 13
 Cypress

- McDowell Jane (*McDowell & Co.*), boards 12
Cypress
- McDowell John, grocer, 128 East av. h. do.
- McDowell Simon V. clerk, 7 Exchange, h. 3
Chestnut park
- McDowell Thomas, removed to Pembroke
- McDOWELL & CO.** (*H. and J. McDowell
and W. G. Watson*), ladies' goods, 53
State.—*See page 547*
- McElhinny Electa, widow, h. 26 Savannah
- McElhinny James J. removed to DeWitt
- McELHINNY JOHN W.** contractor, 47
Chestnut, house do.—*See page 633*
- McEllicot Julia, widow, house 31 Bolivar
- McElrone Bernard, saloon, 27 Monroe av.
house do.
- McElrone John, deceased Sept. 1875
- McElrone John, laborer, house 44 Howell
- McElrone Rebecca S. grocer, 131 South St.
Paul, house do. [Kent
- McElroy James, carpenter, house Lind cor.
- McElroy James, removed to Springfield, Mo.
- McElroy John G. clerk, 4 Griffith, house 98
Pinnacle avenue [Kent
- McElroy Mary, spectacle maker, b. Lind c.
- McElroy Robert, shoemaker, 73 N. Water, h.
63 Orange [b. Lind c. Kent
- McElroy William, shoemaker, 87 N. Water,
- McElwain Andrew, carpenter, Minerva al.
house 4 Sherman [Hill
- McElwee Samuel H. moulder, 8 Hill, h. 26
- McEntee Charles P. carriage smoother, bds.
59 Spring [park near Fourth
- McEntee Eugene J. shoemaker, h. Glenwood
- McEntee George, carriagemaker, 3 Canal, h.
87 Hunter [South Ford
- McEntee James, blacksmith, 3 Canal, h. 40
- McEntee James jr. carriage painter, 3 Canal,
b. 12 N. Washington [Glenwood av.
- McEntee Patrick, shoemaker h. Fourth near
- McEntee Sylvester, removed to Philadelphia,
Pa. [Lyell
- McEvoy Edward, laborer, h. Lake av. cor.
- McEvoy Elizabeth M. Miss, dressmaker, 168
State, boards 180 do.
- McEvoy John, laborer, b. Field n. Monroe av.
- McEvoy John J. shoemaker, 111 State, bds.
113½ E. Main [State, b. 180 do.
- McEvoy Maggie F. Miss, dressmaker, 168
- McEvoy Mary, widow, house 157 Jones
- McEvoy William, laborer, house Field near
Monroe avenue
- McFadden John, expressman, h. 172 State
- McFarlan Bernard, painter, 165 E. Main, b.
r. 27 Hill [Hope avenue
- McFarlan Francis, carpenter, house 94 Mt.
- McFarlan Peter, laborer, house 27 Brown's al.
- McFarland Andrew J. box maker, 22 S. St.
Paul, boards 68 Bolivar
- McFarland John, box maker, 22 S. St. Paul,
boards 68 Bolivar
- McFarland John, carpenter, house 68 Bolivar
- McFarlane Anna, widow, h. 135 Caledonia av.
- McFarlane Robert, foreman, 43 N. Water, b.
135 Caledonia avenue
- McFarlin Benj. contractor, h. 115 West av.
- McFarlin Bridget, widow, house 107 Scio
- McFarlin Chas. at papermill, b. 114 Lake av.
- McFarlin George, chairmaker, boards 114
Lake avenue
- McFarlin Francis M. manager, 10 State, h.
117 West avenue
- McFarlin Jennie, dressmaker, b. 114 Lake av.
- McFarlin John P. porter, 46 Mill, b. 107 Scio
- McFarlin Mary, widow, house 100 Adams
- McFarlin Michael, stairbuilder, h. r. 27 Hill
- McFarlin Patrick, watchman, Court House,
house 19 Weld
- McFarlin Rowland B. boards 115 West av.
- McFarren William R. clerk, Erie Railway
freight house, house 89 Plymouth av.
- McFiggin Marcom, plasterer, h. 250 North
- McGahan Ann, widow, house 64 Joiner
- McGahan Ella, dressmaker, 18 E. Main, b.
64 Joiner
- McGahan William, teamster, h. 13 Cameron
- McGan Ann, widow, 92 South avenue
- McGarity Arthur, cabinet moulder, 69 N. St.
Paul, house 67 Thompson
- McGarrey Mary M. boards 34 Joiner
- McGarry Edward J. clerk, 66 State, bds. 77
Frank
- McGarry Patrick, boarding house, 35 North
St. Paul, h. do. [Plymouth avenue
- McGeary Ann, widow, house Cottage near
- McGee James, grocer, 110 East av. h. do.
- McGee James, nurseryman, h. 21 Hickory
- McGee John, tanner, h. 37 Brown's alley
- McGee Michael, laborer, house 71 Hunter
- McGee Patrick, stonecutter, bds. 21 Hickory
- McGee Patrick, driver, 4 West Main, bds. 71
Hunter [317 State
- McGee Patrick H. engraver, 12 E. Main, h.
- McGiffert William D. bookkeeper, 17 State,
boards 36 North Washington
- McGill Henry B. machinist, 124 Mill, house
150 Frances
- McGill James, laborer, h. Flint n. Frances
- McGill John (*McGill & Slade*), 195 E. Main,
house 15 Union park [Magne
- McGill John, framemaker, 8 Allen, boards 3
- McGill John, foreman, house 14 Flint
- McGill John H. gasfitter, boards 14 Flint
- McGill Joseph P. laborer, Gas Works, b. 14
Flint
- McGill Michael, house 43 Chatham
- McGill Patrick, bookkeeper, boards 142½ W.
Main [near Frances
- McGill Patrick, foreman, Gas Works, h. Flint
- McGill Patrick A. laborer, Gas Works, boards
Flint near Frances
- McGill Peter, removed to Williamstown, Pa.
- McGill Rosa Miss, perfumer, 205 Plymouth
avenue, h. 9 Flint [15 Moore
- McGill Samuel, framemaker, 8 Allen, house
- McGill Sarah M. dressmaker, 3 Magne, b. do.
- McGill William, moulder, house 3 Magne
- McGill William, carriage maker, 3 Canal, b.
62 West avenue
- McGill William H. machinist, bds. 3 Magne
- McGill & Slade (*John McGill and Henry B.
Slade*), produce dealers, 195 E. Main
- McGillick John, laborer, h. 231 Plymouth
avenue
- McGillicuddy Ellen, widow, b. 110 Bartlett
- McGinly Mary, widow, boards 25 Favor

- McGinly Rose, dressmaker, boards 25 Favor
 McGinn Isabella, dressmaker, 33 Jones, h. do.
 McGinn Margaret, seamstress, h. Thompson
 near House of Refuge
 McGinness James, teamster, h. 66 Caroline
 McGinnis Bella, servant, Osburn House
 McGinnis Elizabeth, rem'd to Brooklyn, L. I.
 McGinniss James teamster, house 37 Lyell
 McGinniss Nellie, stitcher, b. rear 272 State
 McGinniss John, actor, 98 Front, b. 96½ do.
 McGinniss Michael, laborer, bds. 66 Caroline
 McGinniss Michael, laborer, house 151 Lewis
 McGinniss Sarah, house Brown corner Frank
 McGinty Charles, clerk, Ayer's Hotel, house
 238 North
 McGivern Hugh, laborer, h. 154 N. Clinton
 McGlachlin Ambrose C. clerk, Leighton
 Bridge and Iron Works, b. 53 Atkinson
 McGlachlin H. F. Mrs. boarding house, 53
 Atkinson [boards 114 Adams
 McGladdery James, tallyman, Platt c. Kent,
 McGlue Luke J. clerk, house 18 S. Ford
 McGlue Mary, widow, house 18 S. Ford
 McGlue Thomas, expressman, b. 18 S. Ford
 McGlynn Catharine, widow, house 245 State
 McGlynn John, laborer, house 13 Atwater
 McGlynn Margaret, widow, house 13 Atwater
 McGlynn Patrick, laborer, 65 N. Water, b.
 13 Atwater [house 24 Ward
 McGoey Thomas, foreman, 141 N. Water,
 McGonegal George E. county supt. of poor,
 63 Front, house at Alms House
 McGonegal Henry B. farmer, house Culver
 corner Webster road
 McGonegal Lizzie A. principal Hudson
 School, No. 16, boards 21 Mathews
 McGonegal Maria, widow, house 21 Mathews
 McGorray Catharine Mrs. house 14 White
 McGorray John, nurse-ryman, h. 8 Costar
 McGorray John A. lawyer, 90 W. Main, h.
 195 Oak
 McGorray Joseph, laborer, 42 Frank, b. do.
 McGorray Mary J. teacher, Whitney School,
 No. 17, boards 14 White [h. 20 Cliff
 McGorray Patrick, cooper, Brown's alley,
 McGorray Thomas, cooper, boards 21 Lyell
 McGougan James, laborer, house 16 Gregory
 McGougan John, laborer, house 16 Gregory
 McGovern Annie Mrs. boarding house, 167
 State, house do.
 McGovern Michael, laborer, house 167 State
 McGovern Peter, cabinet maker, b. 49 Frank
 McGovern Susan, stitcher, boards 49 Frank
 McGovern James, waiter, bds. Brown. cor.
 Brown's alley
 McGoveron Thomas, clerk of Holy Sepul-
 chre cemetery, h. Brown c. Brown's al.
 McGowan Agnes, widow, house 19 Charlotte
 McGowan Alice Mrs. laundress, h. 57 Frank
 McGowan Annie, domestic, b. r. 36 Griffith
 McGowan Daniel, agent, 3 Canal
 McGowan John J. bookseller, 102 W. Main,
 boards European Hotel
 McGowan William, expressman, 83 State,
 bds. 54 Platt
 McGrady Andy, laborer, 108 N. St. Paul
 McGrady Edward, laborer, b. 25 Vincent pl.
 McGrady Elizabeth, widow, boards 9 Kent
 McGrady Hugh, blacksmith, 3 Canal, house
 32 Julia [Vincent pl.
 McGrady John, boiler maker, boards 25
 McGrady Owen, laborer, h. 25 Vincent place
 McGrady Peter, carriage maker b. 9 Kent
 McGraham John, bartender, 159 Lake av.
 boards do. [house 31 Spencer
 McGrath Daniel, shoemaker, 73 N. Water,
 McGrath Dennis, blacksmith, 4 S. Washing-
 ton, boards 37 Frank
 McGrath Elizabeth, widow, boards 15 Sophia
 McGrath Jeremiah, shoemaker, 83 N. Wa-
 ter, boards 31 Spencer [av. bds. do.
 McGrath John G. coachman, 44 Plymouth
 McGrath Katie, domestic, boards 206 State
 McGrath Martin, watchman, 159 State, bds.
 Allen corner Elizabeth
 McGrath Patrick, grocer, 83 Mt. Hope av.
 house do.
 McGrath Thomas, carpenter, h. 29 William
 McGrattan Patrick, last maker, 123 Mill, h.
 16 Vincent place
 McGraw Bridget, paster, bds. 19 Brown's al.
 McGraw Hiram, shoemaker, h. Park avenue
 near Bowen
 McGraw John (*McGraw & Co.*), h. at Ithaca
 McGraw John 2d (*McGraw & Co.*), house 11
 Alexander
 McGraw Kate, packer, boards 17 West
 McGraw Margaret, servant, boards 17 West
 McGraw Martin, laborer, house 17 West
 McGraw Martin, watchman, boards 25 Allen
 McGraw Mary, widow, house 19 Brown's al.
 McGraw Mary, widow, boards 3 Maple place
 McGraw Mary A. widow, house 51 Frost av.
 McGraw Peter, mason, h. 103 Mt. Hope av.
 McGraw Thomas, laborer, b. 103 Mt. Hope
 avenue [at Portsmouth, Michigan
 McGraw Thomas H. (*McGraw & Co.*), house
 McGraw & Co. (*J., T. H. and J. McGraw 2d,*
 and I. S. Bennett), lumber, 73 Alexander
 McGrayan Anna Miss, removed to Denver,
 Colorado [boards 142½ W. Main
 McGrayan Katie Miss, millinery, 144 State,
 McGregor B. Rush, dentist, 184 Powers'
 buildings
 McGregor Elizabeth, deceased, January 1876
 McGregor Henry, boatman, house Plymouth
 avenue n. rapids
 McGregor James H. clerk, h. 32 Prospect
 McGregor John E. actor, Opera House, h.
 198 West Main [boards 37 Glasgow
 McGregor William H. peddler, 7 Exchange,
 McGregor William J. grocer, 32 Prospect,
 boards do. [b. Scio n. railroad
 McGuan Michael, laborer, N. Y. C. R. R.
 McGuckin Edward, laborer, h. Genesee cor.
 Rapids road
 McGuckin Edward, cooper, h. 25 Brown's al.
 McGuckin James, boards 102 Mill [Bowen
 McGuire Alfred, farmer, house East av. opp.
 McGuire Andrew, laborer, house 39 South
 Washington
 McGuire Ann, domestic, 91 Lake avenue
 McGuire Ann, widow, house 3 Syke
 McGuire Catharine, widow, h. 16 S. Ford
 McGuire Chas. J. blacksmith, 3 North av.
 house 39 Atkinson

- McGuire Elizabeth, widow, b. 44 Edinburgh
 McGuire Fanny, house Park av. near Culver
 McGuire Hugh J. clerk, 53 E. Main, house
 25 Manhattan
 McGuire Isabella, clerk, boards 48 Frank
 McGuire Isabella Miss, bds. 3 Franklin sq.
 McGuire James, laborer, bds. 22 Campbell
 McGuire James, farmer, b. East av. opp. Bowen
 McGuire James, marble polisher, 122 S. St.
 Paul, boards 143 East Main
 McGuire James, laborer, h. r. 71 Pinnacle av.
 McGuire James, laborer, h. Sibley n. Culver
 McGuire James, teamster, rear S. St. Paul
 opposite Griffith, house do.
 McGuire Jas. F. removed to Arcade, N. Y.
McGUIRE JAMES H. wholesale confec-
 tioner, 60 W. Main, house 37 Fitzhugh.
 —See page 560
 McGuire John, millwright, paper mills, h.
 Clarkson corner Champion
 McGuire John, teamster, boards South St.
 Paul opposite Griffith
 McGuire John, laborer, h. Culver cor. Sibley
 McGuire John, deceased November, 1875
 McGuire John W. tucker, boards 43 Platt
 McGuire J. Horace, assistant deputy County
 clerk, Court House, house 23 Tremont
 McGuire Libbie, papermaker, bds. Clarkson
 corner Champion
 McGuire Mark, laborer, house 22 Campbell
 McGuire Michael, deceased Feb. 29, 1876
 McGuire Patrick, cooper, 1 St. James park,
 house 40 Spencer
 McGuire Rosa, widow, bds. 25 Manhattan
 McGuire Susan, widow, house 48 Frank
 McGuire Thomas, marble polisher, 122 South
 St. Paul, boards 143 East Main
 McGuire William, teamster, house rear South
 St. Paul, opposite Griffith
McGUIRE WILLIAM D. & CO. (*R. E.*
Winterstein), merchant tailors, 8 Elwood
 block, h. 6 Greenwood av.—See page 536
 McGuire, see Maguire
 McGukin George, teamster, h. Thurston road
 McGurn James, salesman, 53 E. Main, boards
 Whitcomb House
 McHale James H. moulder, b. 17 Shamrock
 McHale Michael, peddler, h. 17 Shamrock
 McHale Thomas, painter, bds. 17 Shamrock
 McHardy Sarah C. widow, house 8 Stone
 McHeath Wm. carpenter, h. Third n. Rowe
 McHenry Ella Mrs. boards 29 William
 McHenry James, hackman, 6 Lancaster, h.
 25 do.
 McHugh James, clerk, house 20 Griffith
 McHugh James, liveryman, house 67 Baden
 McHugh Kate Mrs. clerk, 91 E. Main, house
 20 Griffith
 McHugh Marcella, widow, h. 55 Delaware
 McHugh Martin W. file cutter, 107 Mill, bds.
 34 Bartlett
 McHugh Mary Miss, 205 Plymouth av. bds.
 34 Bartlett
 McHugh Patrick, laborer, house 34 Bartlett
 McInerney James, bootmaker, 141 N. Water,
 boards 227 North St. Paul
 McInerney John, laborer, 141 North Water,
 house 227 North St. Paul
- McInerney John jr. bootmaker, 141 N. Water,
 boards 227 North St. Paul
 McInerney Michael, switchman, boards 227
 N. St. Paul [Water, b. 227 N. St. Paul
 McInerney Peter J. rubber maker, 141 North
 McInerney William G. blacksmith, house 27
 Thompson
McINTOSH, AIKENHEAD & CO. (*J. D.*
McIntosh, W. and J. M. Aikenhead), soap,
 candles and tallow, 55 Front.—See p. 553
 McIntosh James D. (*McIntosh, Aikenhead &*
Co.), house 218 Alexander
 McIntosh James R. blacksmith, h. 60 Bartlett
 McIntosh John, tobacconist, 6 E. Main, house
 77 South Union
 McIntosh John R. maltster, b. 218 Alexander
 McIntosh Mary, boards 218 Alexander
 McIntosh Nancy, widow, house 5 Delevan
 McIntosh, see Mackintosh
 McIntyre Candace, milliner, b. 126 Tremont
 McIntyre Catharine, cook, bds. 40 N. Water
 McIntyre Charles, clerk, boards 15 Smith
 McIntyre Clara, widow, boards 22 Caledonia
 avenue
 McIntyre Daniel, laborer, h. 111 N. Clinton
 McIntyre Elias J. optician, 179 N. St. Paul,
 boards 42 Martin
 McIntyre James A. mason, boards 15 Smith
 McIntyre Joseph E. spectacle maker, boards
 42 Martin
 McIntyre Kate Miss, clerk, boards 11 Moore
 McIntyre Patrick, carpenter, house 8 Gregory
 McIntyre Patrick, lawyer, 70 Arcade, boards
 15 Smith
 McIntyre Robert, contractor, house 15 Smith
 McIntyre Robert jr. foreman, Brown cor. Oak,
 house 63 Wilder
 McIntyre Sarah M. Mrs. bds. 126 Tremont
 McIntyre Susanna Miss, boards 33 Frank
 McIntyre William, laborer, b. 111 N. Clinton
 McIntyre William J. stonemason, h. 8 Walnut
 McKale Jane, nurse, house 44 South Union
 McKane Alice Miss, bds. 71 Mt. Hope av.
 McKane Michael, gardener, house 71 Mt.
 Hope avenue [17 Atkinson
 McKanna John, driver, 121 West Main, bds.
 McKanna Katie, dressmaker, b. 136 S. St. Paul
 McKay Bridget, widow, h. 95 S. St. Paul
 McKay David, city assessor, City Hall, h.
 5 Caledonia avenue
 McKay Dennis, laborer, bds. 121 S. St. Paul
 McKay James D. saloon, 7 Mumford, h. 28
 Stillson
 McKay Sidney, civil engineer, water works,
 City Hall, house 15 Stillson
 McKay Stanley A. student, University of
 Rochester, boards 10 St. Joseph
 McKay William E. butcher, h. 109 Averill
 McKay, see Mackay
 McKearney Agnes, clerk, boards 11 Marietta
 McKearney Louise, teacher, Whitney School,
 No. 17, boards 11 Marietta
 McKearney Patrick, engineer, h. 11 Marietta
 McKechney Wm. house West near Costar
 McKechney Margaret, rag sorter, h. West
 near Costar
 McKechney William, moulder, Brown's race
 near Furnace, house 13 Clifton

McKechnie Charles, laborer, Brown c. Jones, house 153 Jones
 McKechnie Martha E. stitcher, bds. 84 Kent
 McKee David C. clerk, 98 Mill, h. 156 State
 McKee D. Elmore, clerk, 82 State, boards 60 Fitzhugh
 McKee Edward, painter, boards 1 Leopold
 McKee Edwin S. carpenter, b. 21 Woodbury
 McKee Eliza, widow, house 56 Clinton
 McKee James S. carpenter, bds. 56 Clifton
 McKee Jane Miss, weaver, boards 56 Clifton
 McKee Jay D. bookkeeper, 25 State, boards 60 Fitzhugh
 McKee John, agent, boards 169 East Main
 McKee Josiah, conductor, N. Y. C. R. R. house 13 Woodbury
 McKee Martha Miss, weaver, bds. 56 Clifton
 McKee Mary Miss, weaver, boards 56 Clifton
 McKee Robert, policeman, City Hall, house 139½ Adams
 McKee Samuel R. house 21 Woodbury
 McKee Steward, painter, house 1 Leopold
 McKee Wm. E. carpenter, b. 21 Woodbury
 McKelvey Byron E. cigarmaker, b. 3 Spencer
 McKelvey Charles E. physician, 93½ State, boards 67 Lake av. [36 Saratoga av.
 McKelvey James, policeman, City Hall, h.
 McKelvey James A. mason, house 30 Vose
 McKelvey John, cooper, Brown's alley near Smith, house 67 Lake avenue
 McKelvey John, clerk, Post Office, bds. 67 Lake avenue
 McKelvey Robert J. machinist, Mill corner Factory, boards 36 Saratoga avenue
 McKelvey William, policeman, City Hall, h. 3 Spencer [toga av.
 McKelvey Wm. H. machinist, bds. 36 Saratoga
 McKelvey Wm. J. bookkeeper, 7 Exchange, boards 67 Lake avenue
 McKenna Ann Miss, house 133 Frank
 McKenna Ellen, widow, boards 27 Smith
 McKenna Frank, car coupler, house 27 Smith
 McKenna Frank, boards 105 Bartlett
 McKenna Hugh, carpenter, bds. 68 Cypress
 McKenna James P. upholsterer, 42 E. Main, boards 31 East avenue
 McKenna John, grocer, 260 State, house do.
 McKenna John F. carpenter, 97 Exchange, house St. Joseph n. Hayward park
 McKenna Patrick, laborer, house 8 Pine
 McKenna Terence, peddler, 144 West Main, house 105 Bartlett
 McKenna Thomas B. (J. O'Donoghue & Co.), 42 East Main, boards 31 East avenue
 McKenner Joseph, chaplain, St. Mary's Hospital, West av. c. Genesee, bds. do.
 McKenney James H. clerk, 86 West Main, boards 56½ Kirk
 McKenney Patrick, laborer, house 56½ Kirk
 McKenney Solon A. removed to Lockport
 McKenney, see McKinney
 McKenny Edward D. carpenter, b. 102 Mill,
 McKenzie James C. veterinary surgeon, and (J. C. McKenzie & Co.), 1 Allen, house 95 Frank

McKENZIE J. C. & CO. (W. H. Dwyer), horse shoers, 1 Allen.—See page 558
 McKenzie Joseph R. removed to Scotland

McKenzie Kittie, teacher, b. 146½ W. Main
 McKenzie Letitia Miss, removed to Leeds, England
 McKenzie Wm. J. removed to Leeds, Eng.
 McKeon Frank, laborer, Mill c. Factory, b. 48 Brown's alley [b. 42 Brown's al.
 McKeon Frank J. shoemaker, 83 N. Water,
 McKeon Hannah, widow, h. 42 Brown's al.
 McKeon James, leather finisher, h. 3 Ward
 McKeon James, machinist, b. 42 Brown's al.
 McKeon Margaret, bookkeeper, 68 W. Main, boards 3 Ward [Genesee, b. do.
 McKeon Patrick, engineer, West avenue c.
 McKeon Peter F. machinist, Brown c. Jones, boards 3 Ward [Ambrose
 McKeveigh John jr. clerk, h. Frank corner
 McKevitte Wm. H. coachmaker, 3 Canal, h. 58 Prospect
 McKewin Ellen Miss, h. 52 Spring [Mich.
 McKeytrick Emily Mrs. removed to Winona,
 McKeytrick Patrick, laborer, h. West near Costar
 McKeytrick Peter, laborer, b. West n. Costar
 McKibben John, real estate, bds. Union cor. Monroe avenue
 McKibben Leverett K. removed to Penfield
 McKillip Abigail, widow, h. 33 Culver park
 McKillip Monroe, deceased July, 1875
 McKillip Wm. P. bookkeeper, N. Y. C. R. R., Brown, h. Frank opp. Jones square
McKILLIP JOHN & CO. (G. B. Boardman), commercial agency, 6 State.—See page 507
 McKindley James W. hardware, &c. 25 West Main, house 157 Alexander
 McKindley Wm. H. clerk, 25 W. Main, bds. 157 Alexander
 McKinley John, baker, house 10 S. Ford
 McKinney Bridget, boarding house, h. 218 West Main [n. Erie canal
 McKinney Edward, laborer, b. Child's alley
 McKinney Geo. W. broker, h. 1 Newton blk.
 McKinney James, deceased May, 1875
 McKinney James P. removed to Mississippi
 McKinney John, laborer, h. Norton n. North avenue [Seminary, b. Trevor Hall
 McKinney John jr. student, Roch. Theological
 McKinney Louie O. student, b. 37 S. Union
 McKinney Margaret, widow, h. 5 Putnam
 McKinney Merritt G. lawyer, 159 Powers' bldgs. boards 37 South Union
 McKinney Orange W. clerk, h. 37 S. Union
 McKinney Robert, stonecutter, 22 West av. boards 37 Glasgow
 McKinney, see McKenney
McKINSTER GILBERT G. nursery, Webster road n. Culver, h. do.—See page 592
 McKissick David C. removed from city
 McKittrick Augustus L. salesman, 53 East Main, house 24 Cypress
 McKittrick Sara Miss, boards 24 Cypress
 McKown Edward J. saloon, Centre n. Mill, house do. [Centre, h. 36½ Lyell
 McLachlan Arthur C. carriage painter, foot
 McLane Owen, McLean's Hotel, Centre c. Mill
 McLarny James, groom, State cor. Centre, boards 9 Oak [West avenue
 McLaughlin Ann, house cleaner, house 65

- McLaughlin Bernard, removed to Brighton
 McLaughlin Daniel, cooper, house 94 Troup
 McLaughlin Daniel jr. shoemaker, boards 94 Troup [avenue
 McLaughlin Edward, laborer, h. 31 Monroe
 McLaughlin Edward, sawyer, 13 Warehouse, boards 20 West [Monroe av.
 McLaughlin Edward, locktender, house 201
 McLaughlin Edward, carman, h. 145 South avenue
 McLaughlin Edward, laborer, h. 21 Spring
 McLaughlin Edward jr. carpenter, bds. 145 South avenue
 McLaughlin Geo. boards 43 Bolivar
 McLaughlin James, machinist, 138 Mill, h. 33½ Spencer [b. 43 Brown block
 McLaughlin Jas. cigarmaker, 48 Exchange,
 McLaughlin James M. grainer, h. 2 Edinburgh court [burgh court
 McLaughlin James S. painter, bds. 2 Edinburgh
 McLaughlin Jane, widow, h. 163½ Atkinson
 McLaughlin Jane E. Miss, trimmer, boards 163½ Atkinson
 McLaughlin John, laborer, h. Sibley n. Bates
 McLaughlin John, removed to Penn Yan
 McLaughlin John, carpenter, car shop, house Second avenue
 McLaughlin Kate Miss, h. 37½ Spring
 McLaughlin Mary Mrs. house 6 Hamburg
 McLaughlin Matthew, teamster, boards 16 Vincent place
 McLaughlin Michael, house 35 Jones
 McLaughlin Patrick, laborer, h. 43 Bolivar
 McLaughlin Reuben M. painter, boards 2 Edinburgh court
 McLaughlin Robert, laborer, h. 6 Sherman
 McLaughlin Stephen, coachman, 45 Plymouth avenue, boards do.
 McLaughlin Wm. carpenter, b. 145 South av.
 McLaughlin Wm. B. coachman, 41 Frank
 McLaughlin Wm. S. tailor, house 51 University avenue
 McLaughlin —, widow, h. 20 Brown's al.
 McLaughlin Phebe, widow, h. 10 Marion
 McLea Sarah, widow, h. 91 Sibley's block
 McLean Aaron M. (*McLean & Johnson*), h. 7 Madison [Hall, h. 11 S. Clinton
 McLean Alexander, chief of police, City
 McLean Alexander E. produce, 347 State, h. 32 Sherman
 McLean Alice, laundress, bds. 130 North av.
 McLean Arthur, sign painter, 88 Arcade, b. 54 Monroe avenue
 McLean Frank H. driver, East av. omnibus, boards East av. corner Wilder place
 McLean Hector, assignee, Farmers' and Mechanics' Bank, 39 Powers' bldgs. house 83 Lake avenue
 McLean Hector L. real estate, house 144 Mt. Hope avenue [c. Wilder pl.
 McLean Horton, teamster, house East av.
 McLean James, laborer, boards 4 Plum alley
 McLean John, blacksmith, bds. 4 Plum alley
 McLean John J. postal clerk, N. Y. C. R. R. house 10 Edmonds
 McLean Lucy, milliner, boards 30 North av.
 McLean Mabel, widow, house 4 Plum alley
 McLean Mary I. trimmer, boards 78 Oak
 McLean Robert, laborer, State cor. Centre, house 7 Penn
 McLean William, boards 51 Spring
 McLean William, nurseryman, boards East avenue corner Wilder place
 McLean Wm. H. shoemaker, h. 64 Frances
McLEAN & JOHNSON (*A. M. McLean and T. L. Johnson*), insurance agents, 27 Arcade.—See page 509
 McLean, see McClain
 McLear Joseph, laborer, house 98 Wilder
 McLellan James B. carpenter, house Third near Rowe
 McLeod Annette S. teacher, bds. 4 Comfort
 McLeod Elizabeth, widow, boards 7 Sophia
 McLeod Gibson, blacksmith, 9 Front, boards 34 N. Washington [Washington
 McLeod Gordon I. blacksmith, boards 34 N.
 McLeod Marion E. teacher, Munger School, No. 13, boards 4 Comfort
 McLeod Mary J. widow, house 4 Comfort
 McLimen Elizabeth, widow, h. 5 Tonawanda
 McLimen James, tinsmith, b. 5 Tonawanda
 McLiman Joseph, bleacher, 38 Mumford, b. 5 Tonawanda
 McMahan Annie F. dressmaker, b. 5 Amity
 McMahan Bridget E. dressmaker, 22 Scio, boards do. [bds. 22 Scio
 McMahan Bryant C. student, 24½ East Main,
 McMahan Charles E. laborer, b. 10 Marshall
 McMahan Edward, carpenter, house Erie canal near Field
 McMahan George C. painter, b. 74 Atwater
 McMahan Henry E. carriage maker, house 148 Mt. Hope avenue
 McMahan James, laborer, h. 76 Caledonia av.
 McMahan James, blacksmith, h. 57 Brown block
 McMahan James L. carpenter, h. 10 Marshall
 McMahan John, laborer, house 9 Woodbury
 McMahan John, inspector, water works, City Hall, house 22 Scio
 McMahan John A. boatbuilder, b. 10 Marshall
 McMahan Martin, grocer, Martin c. Lowell, house do. [change
 McMahan Mary A. widow, house rear 94 Ex-
 McMahan Michael, teamster, h. 85 Cypress
 McMahan Michael J. clerk, 159 West Main, boards 148 Mt. Hope avenue
 McMahan Michael J. salesman, 24 State, b. 126 Fitzgugh
 McMahan Patrick, laborer, Lyell cor. West, house Thompson near Jones avenue
 McMahan Patrick, laborer, house 78 Cypress
 McMahan Patrick 2d, melter, h. 77 Cypress
 McMahan Patrick, machinist, 123 Mill, house 30 Smith
 McMahan Patrick, laborer, h. 16 Caroline
 McMahan Philip, currier, h. 4 Fulton av.
 McMahan Thomas, brakeman, Erie Railway, house at Corning
 McMahan Thomas, carpenter, h. 74 Atwater
 McManis Anna Miss, tailoress, 77½ North av. house 95 do. [bds. 95 do.
 McManis Margaret, seamstress, 77½ North av.
 McMannis Ann, widow, bds. 24 Edinburgh
 McMannis Elizabeth, widow, house Flint n. Plymouth avenue

- McMannis James, groceries, 24 S. St. Paul, house 38 South Clinton
 McMannis James P. bookkeeper, h. 89 Frank
 McMannis James T. (*Maxwell, Newman, McMannis & Co.*), 22 South St. Paul, b. 38 South Clinton
 McMannis John, clerk, 24 S. St. Paul, bds. 38 S. Clinton [h. 182 Brown
 McMannis John, engineer, N. Y. C. R. R.
 McMannis John, carpenter, house 1 Orange
 McMannis Mary Mrs. house 13 Ward
 McMannis Nancy, house 60 Thompson
 McMannis Patrick, conductor, N. Y. C. R. R. house 197 North
 McMannis Peter, nurseryman, bds. 5 Hunter
 McMannis Rosanna, widow, house 80 Ontario
 McMannis Sarah, widow, house 88 Chatham
 McMannus Edward, grocer, 96 East avenue, house do.
 McMannus Edward, carpenter, h. 12 Kirk
 McMannus Edward jr. carpenter, boards 96 East avenue
 McMannus John, carpenter, bds. 96 East av.
 McMaster Alonzo D. agent, h. 4 Chestnut pk.
 McMaster Alonzo D. jr. clerk, 9 W. Main, boards 4 Chestnut park
 McMaster Joseph M. pipe inspector, boards 4 Chestnut park
 McMaster Samuel O. boards 4 Chestnut park
 McMath B. Caroline, widow, bds. 25 George
 McMath Edwin A. lawyer, 101 Powers' bldgs. house 25 George
 McMath Morrison H. student, University of Rochester, boards 25 George
 McMenomy Ann, widow, house 45 Lowell
 McMenomy Edward, mason, bds. 45 Lowell
 McMenomy Michael, shoemaker, 55 Mill, boards 43 Lowell
 McMenomy Patrick J. stone quarry, rear 131 North St. Paul, house Livingston
 McMichael Jas. D. switchman, b. 34 Smith
 McMichael John, carpenter, house 34 Smith
 McMichael John, cooper, house 101 Magne
 McMichael Mary, carpet weaver, boards 101 Magne
 McMillan James, boards 4 Spencer
 McMillan Richard B. agent, house 22½ Frank
 McMillan Thomas, grocer, 107 Plymouth av. house 105 do.
 McMillan Wm. S. & Co. millers, Crescent Mills, South Water, house 42 Lorimer
 McMorrow John A. tobacconist, 238 State, house do. [change
 McMullen Allen R. shoemaker, bds. 157 Ex-
 McMullen Bridget, saloon, 31 St. Paul, h. do.
 McMullen Bros. (*J. & P. McMullen*), truckmen, 4 Exchange
 McMullen Catharine, housekeeper, 12 Oak
 McMullen Clara S. widow, house 13 John
 McMullen James, laborer, h. Bates n. Sibley
 McMullen James, boards 55 Edinburgh
 McMullen James, constable, house 21 Bartlett
 McMullen James H. truckman, b. 21 Bartlett
 McMullen John (*McMullen Bros.*), house 55 Edinburgh
 McMullen John, laborer, house 67 Wilder
 McMullen John G. clerk, State c. Centre, h. 114 Cady
 McMullen Julia (*Lynch & McMullen*), house 74 South Ford
 McMullen Michael, laborer, b. Bates n. Sibley
 McMullen Michael, overseer, h. 157 Exchange
 McMullen Michael F. dentist, 110 State, h. 112 Hunter [South Ford
 McMullen Peter (*McMullen Bros.*), house 74
 McMurray Samuel, grocer, Reynolds corner Hunter, house do.
 McNab James H. carpenter, b. 52 Hamilton pl.
 McNab John C. machinist, Mill c. Factory, boards 52 Hamilton place
 McNab Julia, teacher, b. 52 Hamilton place
 McNab Mary A. widow, h. 52 Hamilton pl.
 McNab Sarah L. music teacher, boards 52 Hamilton place
 McNally Catharine, laundress, house 5 Julia
 McNally Fanny, finisher, Platt cor. Mill, h. 208 State
 McNally Fred. book agent, bds. 114 Hudson
 McNally James, blacksmith, Mill c. Factory, bds. 110 Caledonia av. [b. 114 Hudson
 McNally James E. shoefitter, 111½ N. Water,
 McNally John, confectioner, 120 State, house 114 Hudson
 McNally Michael J. mason, h. 75 Manhattan
 McNally Owen, tobacco worker, h. 49 Frank
 McNally Owen, laborer, house 12 Thomas
 McNally Owen J. wagonmaker, 26 Vienna, boards 12 Thomas [house 45 Reynolds
 McNally Thomas, teamster, 163 Exchange,
 McNally William A. confectioner, 39 Exchange, boards 114 Hudson
 McNamara Bridget, widow, bds. 117 Hunter
 McNamara Charles, carpenter, h. 11 Munger
 McNamara Delia, widow, bds. 18 Woodbury
 McNamara James, teamster, bds. 11 Munger
 McNamara Lawrence, laborer, house 9 Vincent place
 McNamara Mary, widow, boards 73 Davis
 McNamara Michael, coachman, 10 Canal, boards do.
 McNamara Patrick, laborer, house Hebard corner Huron [h. 117 Hunter
 McNamara Patrick H. sole cutter, 55 Mill,
 McNary John, carpenter, house 7 Whalin
 McNaught Thomas, painter, 165 East Main, boards Sibley's block [Mathews
 McNaughton Caroline M. widow, boards 8
 McNaughton Christie, boards East avenue c. Alexander
 McNaughton Donald, sec'y Rochester and State Line R. R. 114 Arcade and (*McNaughton & Olmsted*), house at Mumford
 McNaughton Henry D. special deputy county clerk, Court House, boards 27 Fitzhugh
 McNaughton Jemison, removed to Mumford
 McNaughton & Olmsted (*D. McNaughton and W. H. Olmsted*), lawyers, 21 Arcade
 McNeal Elvira, widow, house 14 Tremont
 McNeal Laura E. music teacher, 14 Tremont, boards do. [14 Tremont
 McNeal Luther C. clerk, 21 West Main, h.
 McNeary Elizabeth, embroiderer, h. 95 Frank
 McNeary Mary, embroidery, bds. 95 Frank
 McNeese Anna, widow, house 242 State
 McNeese Anthony, deceased Feb. 28, 1876
 McNeese Margaret, boards 242 State

McNeese William, laborer, boards 242 State
 McNeil Alexander H. carpenter, house 11 Thomas [54 Monroe avenue
 McNeil Charles H. printer, 62 E. Main, bds.
 McNeil Edward, boot treer, b. 137 North av.
 McNeil Isaac, carpenter, 254 North
 McNeil John H. clerk, 16 Exchange, house 40 Hamilton place
 Mc Nerney Augustus G. (*Moore & Mc Nerney*), 60 E. Main opp. Osburn House, house 8 Ward [bds. Chapman House
 Mc Nerney Lot, tailor, 55 Smith's block,
 Mc Nerney William, helper, 3 Canal, house Lyell near Bolivar
 McNett Hiram, mason, boards 24 Spring
 McNett Silas, laborer, house 45 Prospect
 McNickle Isabella, widow, boards 126 Mt. Hope avenue [17 Hand
 McNish Edward, tinsmith, 16 S. St. Paul, h.
 McNish Frances, painter, boards 17 Hand
 McNulty George H. clerk, b. 80 North av.
 McNulty John J. painter, 3 Canal, boards Brown near Frank
 McNulty J. Edward, photographer, 58 State, house 80 North avenue [North av.
 McNulty William H. clerk, 3 Canal, bds. 80
 McOmber Isaac, boards 15 Concord avenue
 McOrmond Henry, machinist, Mill cor. Factory, house Perkins near First
 McPadden Bridget Miss, dressmaker, 104½ Caledonia avenue, house do.
 McPadden Hugh, tallyman, Kent cor. Platt, house 104 Caledonia avenue
 McPadden Mary Miss, h. 104½ Caledonia av.
 McPadden Miles, moulder, boards 5 Hunter
 McPhail Edward (*McPhail & Jones*), 39 Arcade, house 112 Plymouth avenue
 McPhail Henry H. (*McPhail & Jones*), bds. 112 Plymouth avenue
McPHAIL & JONES, (*E. McPhail, W. Martin Jones and H. H. McPhail*), foreign and American financial agents, 39 Arcade.—*See page 508*
 McPherson Alexander, removed to Michigan
 McPherson Donald, tailor, h. 209 Exchange
 McPherson Duncan, cloth sponger, 10 West Main, house 29 Troup
 McPherson George, shoemaker, 77 North Water, house 40 Bolivar [Jay
 McPherson William D. deputy sheriff, h. 84
 McPherson William J. lawyer, 40 Arcade, house 245 Plymouth avenue
 McQuade James (*Harrison & McQuade*), h. 297 State [Rochester, h. 42 Frank
 McQuaid Bernard J. bishop, diocese of
 McQuaid Elizabeth, widow, h. 200 W. Main
 McQuain Charles A. laborer, h. 52 Spring
 McQuain Edward, engineer, N. Y. C. R. R. house 108 Hudson
 McQuain Henry J. painter, house 22 Hunter
 McQuain Terry, house Rapids road at rapids
 McQuaters William, hostler, h. 73 Hickory
 McQuatters Hamilton, boatbuilder, house 13 Alexander [ander
 McQuatters James, contractor, h. 32 Alex-
 McQuatters John C. policeman, City Hall, h. 29 Alexander [Brown
 McQuillen Edward, machinist, boards 378

McQuillen John H. removed to Dunkirk, Pa.
 McQuillen Mary A. Miss, hairworker, 378 Brown, boards do. [N. Union
 McQuillen Patrick, fireman, house Lewis n.
 McQuillen Sarah Mrs. widow, h. 378 Brown
 McQuillen Thomas A. clerk, 118 W. Main, boards 378 Brown
 McQuirk Ann Mrs. domestic, 102 Mill
 McQuivey H. J. Mrs. house 88 West avenue
 McQuivey William F. agent, b. 88 West av.
 McRavey James, laborer, house 15 Kent
 McRoden John H. cutter, 23 E. Main, house 58 North avenue
 McRoden Michael (*McRoden & Co.*), house 24 Andrews
McRODEN & CO. (*M. McRoden*), clothing, 23 East Main.—*See page 539*
 McShane William, laborer, house 113 Jones
 McShane William jr. cooper, 1 St. James park, boards 113 Jones
 McShea Jennie, dressmaker, bds. 38 Romeyn
 McStravick Sarah, widow, house 7 Spring
 McSweeney Daniel, laborer, h. 39 Sanford
 McSweeney Edward, tobacconist, 3 South St. Paul, h. 23 Oregon [h. do.
 McSweeney Eliza, grocer, 135 S. St. Paul,
 McTaggart Daniel, laborer, house 40 Griffith
 McTaggart Daniel jr. machinist, b. 40 Griffith
 McTaggart James (*H. Brewster & Co.*), 72 E. Main, house 59 Platt [64 William
 McTaggart John, miller, 3 North Water, h.
 McTavish Patrick H. carpenter, 127 Mill, h. 234 State [house do.
 McVay Patrick, saloon, Lake av. cor. Lyell,
 McVean Alexander, secretary and treasurer, Sill Stone Co. 187 W. Main, house 105 Fitzhugh
 McVean Catharine, widow, bds. 9 Caroline
 McVean Peter J. packer, 73 East Main, h. 9 Caroline [bds. 3 Waverly place
 McVean William H. moulder, 187 W. Main,
 McVicar Susan M. widow, h. 200 South av.
 McVicar Susie S. teacher, Munger school, No. 13, boards 200 South avenue
 McWain Wallace W. axemaker, house 9 North Ford [34½ John
 McWeeney Catharine Miss, milliner, boards
 McWeeney Patrick J. bookkeeper, 53 East Main, boards 34½ John
 McWhorter Alexander, superintendent, Monroe County Penitentiary, h. do.
 McWhorter Amos, musician, house 236 State
 McWhorter Irving C. (*Curtis & Co.*), 90 W. Main, boards at Brighton
 McWhorter James S. cooper, bds. 236 State
 McWhorter Josephine C. dressmaker, bds. 236 State
 McWilliams John, laborer, h. 59 Lancaster
 Mead Esther M. seamstress, h. 86 Sibley's blk.
 Mead Hannah, widow, house 21 West av.
 Mead Matthew, shoemaker, 2 Mumford, h. 2 Sophia [Clinton place
 Mead William B. cutter, 24 State, house 14
 Meagher Martin, carpenter, house 11½ Monroe avenue
 Meagher Martin M. pastor Church Immaculate Conception, h. 127 Plymouth av.
 Meagher Mary, cook, boards 123 Alexander

Meagher Mary A. newsroom, 70 Jay, h. do.
 Meagher Patrick (*Garin & Meagher*), 147 E. Main, house 84 N. St. Paul
 Meagher Philip F. clerk, 64 State, house 63 Atkinson [Culver
M Measure Stephen, teamster, h. Bates near
MECHANICS' SAVINGS BANK, 15 Exchange.—*See page 498*
 Meck Henry A. carpenter, b. 50 S. St. Paul
 Meck Francis, tailor, 45 Rauber, house do.
 Medberry Joseph, house 39 Spring
 Medbury Thomas, flour and feed, 52 West avenue, house do. [William
 Medcalf Edwin A. student, 14 State, bds. 6
 Medcalf Frederick, rem'd to Portage, N. Y.
 Medcalf Thomas E. bookkeeper, 73 E. Main, house Maple place near Monroe avenue
 Medcalf Wm. C. bookkeeper, h. 6 William
 Medcalf Wm. H. engineer, bds. 6 William
 Medrow Charles, tailor, house 210 N. Clinton
 Medrow Emil A. cutter, 12 West Main, bds. 69 Caledonia avenue [Clinton
 Medrow Paul C. cutter, 63 Mill, h. 210 N. Meehan Frank, clerk, 130 West Main, boards 34 Plymouth avenue
 Meehan James B. Mrs. h. 34 Plymouth av.
 Meehan Mary, widow, house 50 North av.
 Meehan Thos. F. clerk, 46 E. Main, bds. 50 North avenue
 Meehlheison Rachel, widow, b. 41 Delevan
 Meek Agnes Miss, h. r. Stone n. Allen's al.
 Meek Helen L. widow, boards 14 Foehner
 Meek Nancy, widow, boards 30 Broadway
 Meek Sarah, nurse, house 89 South St. Paul
 Meek Thomas, harness maker, 59 Front, h. 89 South St. Paul
 Meeker Abel, lawyer, house 41 Ambrose
 Meeker Geo. R. tinsmith, 196 State, bds. 8 Bloss [avenue
 Meeker John L. carpenter, house 207 Monroe
 Meeker Seely, carpenter, h. 11 Woodford pl.
 Meeker William D. miller, C. B. Hill's, h. 8 Bloss
 Meekins James, waiter, Clinton Hotel, b. do.
 Meeley Thomas, blacksmith, 14 Market, b. 2 Centre [N. St. Paul, h. 27 Scramtom
 Meerdink Gerritt J. woodworker, River near
 Meerdink John W. blacksmith, house 140 St. Joseph
 Meere James, laborer, house 14 Hebard
 Meere Michael, laborer, boards 14 Hebard
 Meerle Frederick, laborer, boards 120 Front
 Megerle George, foreman, house 50 King
 Mehl George, porter, house 42 Spencer
 Mehle Nicholas, machinist, house 303 Brown
 Mehler Joseph, bookkeeper, 63 Mill, boards 50 Court
 Mehne Anna, widow, house 244 St. Joseph
 Mehne Frederick, removed to Albion
 Mehrhof Nicolas, mason, h. 15 Hoeltzer
 Meibam Christian, laborer, house 27 Hoeltzer
 Meier Bernard C. carver, 2 Hill, b. 1 Leopold
 Meier Frederick, laborer, house 32 Hoeltzer
 Meier Henry, laborer, h. Ames n. W. Maple
 Meier Hugo, tailor, house 6 Rhine
 Meier Magdalena, widow, house 1 Leopold
 Meier Simon, saloon, Bauer corner Sherman, house do.

Mein Henry, moulder, h. Childs opp. Lime
 Mein Robert, removed to Constantine, Mich.
 Meinhardt Peter, removed to Brockport
 Meinig Frederica, widow, house 51 Front
 Meinig Otto, file cutter, boards 51 Front
 Meink Dora Mrs. house 62 Herman
 Meintel Felix, carpenter, 14 St. Joseph, h. 70 Joiner
 Meintel Frederick, teamster, house 16 Hope
 Meintel Hugo, mason, house 10 Vienna
 Meirlow Catharine, widow, bds. 2 Bartlett
 Meisch Catharine, widow, boards 307 Brown
 Meisch Charles, harnessmaker, 638 West av. house West Maple near Childs
 Meisch Nicholas, laborer, 144 E. Main, h. 418 Brown
 Meise Ferdinand, laborer, house 70 Kelly
 Meisenzahl Charles jr. pattern maker, Leighton av. house Clifford near Thomas
 Meiser Geo. flagman, John st. crossing, h. 222 Jay
 Meisner George, laborer, h. Whalin n. Grand
 Meister Charles, laborer, house 26 German
 Meister John, laborer, boards 26 German
 Meister Paulina, widow, house 18 Holland
 Meixner Adam, tailor, 39 Nassau, house do.
 Melarkey Peter, carpenter, Arcade, house 1 Frederick [Vienna
 Meldola Theodore, music teacher, house 15
 Meldola Minnie, tailoress, boards 15 Vienna
 Mellen Thomas, painter, house 6 Whalin
 Mellon Anna, clerk, boards 12 Emmett
 Mellon George, peddler, house 12 Emmett
 Mellon Michael J. clerk, 64 State, boards 12 Emmett
 Mellon William J. painter, bds. 12 Emmett
 Mellor Eliza, widow, b. Walnut n. Orange
 Mellor Thomas, machinist, h. Walnut near Orange
 Melville Freeman M. clerk, bds. 25 Madison
 Melville Kate Miss, house 6 Sycamore
 Melville Michael T. carver, 123 State, boards 41½ Romeyn
 Melville Thomas, laborer, house 41½ Romeyn
 Melvin Alexander G. deceased April 9, 1876
 Melvin Cornelius H. salesman, b. 28½ Comfort
 Melvin Edmund A. boards 114 Plymouth av.
MELVIN JAMES, horse shoer and blacksmith, 4 S. Washington, h. 114 Plymouth avenue.—*See page 605*
 Melvin John W. cigarmaker, 48 Exchange, house 108 Atkinson [Clinton
 Memmel August, bootmaker, bds. 337 North
 Memmel Caspar V. shoemaker, 75 N. Water, house 164 St. Joseph
 Memmel Catharine, widow, h. 337 N. Clinton
 Mender Jacob, bartender, 77 Mill, house 86 Chatham
 Mendonsa Frank S. removed from city
 Mendonsa Manuel S. liquors, 65 West av. h. 66 do.
 Meng Albert, clerk, boards 99 North avenue
 Meng Anthony, cutter, 14 Mumford, boards 19 Chatham [19 Chatham
 Meng Charles, hats, caps, &c., 13 State, h.
 Meng Charles jr. clerk, 13 State, house 38 Franklin

Meng Conrad F. carriage painter, r. 145 E. Main, b. 99 North av.
 Meng John, boots and shoes, 103 North av. boards 99 do. [10 Wilder
 Meng John, hairdresser, 192 West Main, bds.
 Meng John D. hairdresser, 10 Wilder, h. do.
 Meng Matthias, boards 26 Mumford
 Meng Peter G. cabinetmaker, Court corner Exchange, boards 12 Shamrock
 Mengel Louis, tailor, house 71 Scrantom
 Mengele John M. cooper, house 72 Saxton
 Mengerink Jenny, domestic, boards 79 Meigs
 Mengerink Wm. machinist, h. 27 Goodman
 Menges Charles, hairdresser, 111 Mt. Hope av. boards do. [16½ Thorn
 Menges Joseph, butcher, 16 Front, boards
 Menn Michael, cutter, 24 State, house 21 Buchan park [park
 Menneiley George W. clerk, b. 5 Gardiner
 Menneiley Samuel D. W. clerk, boards 5 Gardiner park [diner park
 Menneiley William, tinsmith, house 5 Gar-
 Menninger John, mason, h. Bay n. Goodman
 Menor Edward, moulder, 204 State. bds. rear 22 Monroe avenue
 Menor Louisa, widow, house 22 Monroe av.
 Menor Zelia Miss, boards 22 Monroe avenue
 Mensing Henry jr. sawyer, 133 N. Water, b. Campbell near Childs
 Mensing John D. A. (*Mensing, Rahn & Stecher*), house Cataract n. N. St. Paul
 Mensing Mary Mrs. widow, h. 99 Whitney
MENSING, RAHN & STECHER (*J. D. A. Mensing, A. Rahn, and F. A. Stecher*), lithographers, 7 Market.—*See opposite page 544*
 Mensing Theodore W. clerk, 74 E. Main, b. 99 Whitney
 Mention James, bds. St. Joseph n. Atwater
 Mentor Sarah M. Mrs. laundry, h. 41 North avenue
 Menzie John, clerk, county treas. office, Court House, boards 170½ West Main
 Menzies William, moulder, Brown's race n. Furnace, house 3 Montrose
 Mepham Thomas, agent, boards 2 Frank
 Mercer John, gardener, h. Hunter al. n. R. R.
 Meredith Thomas D. carver, 2 Hill, house Wackerman n. Jay [Bartlett, h. do.
 Merick Eldridge J. broom maker, Seward n.
 Merick Wm. D. farmer, h. Thurston road n. Rapids road [St. Joseph
 Merk Laurence A. clerk, 5 N. Clinton. b. 99
 Merk Martin, teamster, house Monroe avenue near tollgate
 Merk Matthias, removed to Bergen, N. Y.
 Merk Modest, carriagemaker, 3 Canal, bds. 4 West avenue
MERK WENDELIN, German bookseller, newsdealer and stationer, 5 N. Clinton, h. 99 St. Joseph.—*See page 514*
 Merkel Albert, marble cutter, 122 South St. Paul, b. Carter n. North avenue
 Merkel Eusebius, teamster, house 71 Frances
 Merkel Jacob, student, Roch. Theological Seminary, boards 118 Alexander
 Merkel Jacob, turner, 135 North Water, h. 126 Champlain

Merkel John, marble polisher, 122 S. St. Paul, house Maria n. Clifford
 Merkel John, laborer, boards 13 Weeger
 Merkel Joseph, cooper, house 43 Martin
 Merkel Lucas, laborer, 38 Gorham, h. Carter near North avenue
 Merkel Michael, stone cutter, 22 West av. house 137 Tremont [7 Maria
 Merkel Richard, yardman, 163 Exchange, h.
 Merkel Simon, tailor, 89 E. Main, boards 5 Goodman
 Merklinger Ellen, stitcher, boards 81 Moore
 Merklinger George, carpenter, Aqueduct, h. Henion place near West avenue
 Merklinger Joseph, stovejoiner, b. 81 Moore
 Merklinger Louis, confectioner, 108 West av. house do.
 Merklinger Mary, widow, house 81 Moore
 Merlau Christina Mrs. bds. 28 N. Frances
 Merlau Conrad, grocer, 42 Lake av. house 50 Lyell [8 Lyell
 Merlau Frederick H. grocer, 330 State, house
 Merlau George clerk, 42 Lake av. b. 50 Lyell
 Merlau Henry, boards 30 North Frances
 Merns Margaret, widow, h. 176 N. St. Paul
 Merrell Augustus H. bookkeeper, 1 Powers' buildings, boards 72 Court
 Merrell Dwight W. painter, h. 37 Monroe av.
 Merrell Henry P. clerk, weighlock, house 72 Court
 Merrill Phebe, boards East av. c. Alexander
 Merriam Fanny A. Miss, teacher Whitney School, No. 17, boards 26 John
 Merriam Hattie A. teacher Madison park school, No. 2, boards 13 W. Troup
 Merriam Henry H. (*Merriam & Co.*), h. 122 Mt. Hope avenue
 Merriam Homer (*Merriam & Co.*), house at Springfield, Mass. [Bolivar
 Merriam John W. jr. shoemaker, house 15
 Merriam John W. carpenter, house 26 John
 Merriam Samuel B. salesman, 11 Mumford, house 62 Alexander [13 W. Troup
 Merriam Syms A. clerk, 90 Plymouth av. h.
MERRIAM & CO. (*H. H. Merriam, C. E. Morris and H. Merriam*), booksellers, 40 West Main.—*See page 518*
 Merrill Edmund W. h. Foehner n. North
 Merriman Corydon C. house East av. corner Goodman
 Merriman Maurice H. real estate, 42 Arcade, house Goodman near East avenue
 Merritt Henry J. house 11 Anson park
 Merritt Louise S. boards 11 Anson park
 Merritt Wm. J. miller, house 49 Hamilton pl.
 Merry John, laborer, 106 S. St. Paul, house 10 Sellinger
 Merry Richard, car driver, boards 26 Centre
 Merry Walter, laborer, boards 10 Sellinger
 Merry William F. blacksmith, Exchange opp. Glasgow, h. 3½ Ward
 Mertin Peter, casket finisher, 22 S. St. Paul, house 65 Weld [house 53 Martin
 Mertz Christian, flour, grain, &c. 54 Front,
 Mertz J. Philip, carver, Jay cor. Erie canal, house 47 Orchard
 Mertz Mina, widow, boards 24 Bartlett
 Mervin Maria, widow, house 126 Tremont

Merz Frederick, house 40 Cypress
 Merz Frederick H. miller, People's Mills, b. 75 Adams
MERZ GEORGE F. miller, People's Mills, Brown's Race near Factory, house 75 Adams.—*See page 552*
 Merz Henry C. flour packer, People's Mills, boards 75 Adams
 Merz Jacob, tailor, house 224 W. Main
 Merz John, boards 40 Cypress
 Merz John F. grocer, 33 Gregory, house do.
 Merz John Jacob, carriage painter, rear 145 East Main, house 57 Cypress
 Merz Michael, teamster, house Mt. Hope av. near Linden
 Merz William, clerk, 82 State, b. 40 Cypress
 Mesick James E. removed from city
 Meske Charles, laborer, house 29 Baden
 Messenger Richard, hackman, house 83 W. avenue [near Clifford
 Messerschmid Charles, mason, house Maria
 Messerschmitt Caspar, cabinetmaker, 71 N. St. Paul, h. 31 Joiner [water, h. 7 Pitt
 Messerschmitt George A. salesman, 9 At-Messinger Charles O. house 16 James
 Messmer George, fancy goods, 295 North Clinton, house do. [Kirk
 Messner Elias, painter, 3 Canal, house 56
 Messner Michael, laborer, house 7 Comfort
 Messurier Enoch L. wood yard, 100 Mt. Hope avenue, house 27 Caroline
 Mestler Louis, harness maker, b. 182 Pinnacle avenue
 Metcalf Arnold, soapmaker, West avenue near Hague, house do. [Hague
 Metcalf George A. farmer, b. West av. n.
 Metcalf J. W. physician, 27 Alexander
 Metcalf William, car driver, h. 31 Brown's alley [b. 47 Charlotte
 Metherell William, blacksmith, 170 E. Main,
 Metropolitan Block, E. Main c. S. St. Paul
 Mets Elijah, cabinetmaker, Jay corner Erie canal, house 12 Perkins
 Mets Peter A. removed to Buffalo
 Metz Henry, tailor, h. Magnolia n. Frances
 Metz Lizzie Miss, tailoress, h. 65 Bartlett
 Metz Valentine, furniture repairer, house 3 Gibbs [h. 45 Childs n. Jay
 Metzger Balthasar, stonecutter, Oak c. Smith,
 Metzger Catharine, widow, h. 11 Foehner
 Metzger Catharine, widow, h. Wackerman near Jay
 Metzger Charles, sawyer, 155 N. Water, b. Flower n. North Clinton
 Metzger Christian, laborer, h. 28 Whitney
 Metzger Clara, midwife, h. 174 N. Clinton
 Metzger Frank, sashmaker, 3 Aqueduct, b. 3 Flower
 Metzger Frederick, brakeman, N. Y. C. R. R. boards 11 Foehner
 Metzger Frederick, mason, h. 142 N. Clinton
 Metzger Jacob, upholsterer, 53 State, house rear Avenue A [47 Childs
 Metzger Jacob, watchman, Oak c. Smith, h.
 Metzger John, clerk, 152 North av. b. do.
 Metzger John, foreman, 136 Mill, h. 207 Scio
 Metzger John A. boilermaker, 138 Mill, h. Mill c. Brown

Metzger Joseph, saloon, Emerson corner Eighth, house do.
 Metzger Margaret, widow, boards 207 Scio
 Metzger Michael, brakeman, N. Y. C. R. R. boards 11 Foehner [Clinton
 Metzger Susan, widow, house Flower n. N.
 Metzger William, removed to Ohio
 Metzger William A. blacksmith, 120 Mill, b. Mill corner Brown
 Metzinger Catharine, widow, h. Jay n. Ames
 Metzinger Jacob, removed to Pine Hill
 Metzinger John, cooper, Ames c. Jay, h. do.
 Metzinger John jr. cooper, b. Ames cor. Jay
 Metzinger Victor, cooper, Magne opposite Walnut, boards Jay near Ames
 Metzler John, shoemaker, 79 N. Water, bds. 30 Glasgow [S. Ford
 Metzler John D. driver, 4 W. Main, house 25
 Metzler Peter, porter, 24 State, h. 30 Glasgow
 Meulendyk Abraham, finisher, 88 State, h. Pennsylvania av. near North Union
 Meulendyk James, laborer, house avenue C
 Meulendyk James jr. upholsterer, bds. av. C
 Meulendyk John, polisher, bds. avenue C
 Meulendyk Susan, seamstress, bds. avenue C
 Mewhirter John, grain dealer, bds. Farmers' Hotel [h. 4 Delevan
 Meyer August, teamster, rear 54 North av.
 Meyer Balzar, shoemaker, 14 N. Water, h. 94 Kelly
 Meyer Balzar, teamster, house near Ulm
 Meyer Benjamin (*S. Meyer & Son*), boards 47 Andrews
 Meyer Bernard, laborer, h. 174 N. Clinton
 Meyer Catharine, grocer, 18 Hanover, h. do.
 Meyer Catharine, widow, boards 14 Stillson
 Meyer Catharine, widow, house r. 4 Delevan
 Meyer Charles, brewer, bds. 171 N. St. Paul
 Meyer Charles, gardener, h. 92 North avenue
 Meyer Charles, laborer, h. Lewis n. Meigs
 Meyer Chas. C. boatbuilder, Meigs st. bridge, and (*Snyder & Meyer*), house 69 Meigs
 Meyer Charles F. (*Rothgangal & Co.*), Erie canal corner Klinck, bds. 28 Broadway
 Meyer Christian, carpet weaver, 8 Nassau, house do. [h. 104 Tappan
 Meyer Christian, moulder, 187 West Main,
 Meyer Christian (*Meyer & Loebbs*), 110 Hudson, house do.
 Meyer Christian M. cabinet maker, 123 Mill, house 8 Delevan
 Meyer Christina, widow, house 132 Lake av.
 Meyer Elizabeth, widow, house 16 Almira
 Meyer Ella V. teacher, Wadsworth School, No. 12, boards 59 Alexander
 Meyer Emil, insurance, boards 12 N. Clinton
 Meyer Emil, butcher, 140 East Main, boards 56 Franklin [h. 6 Nassau
 Meyer Ernest, carpenter, Mansion n. Violetta,
 Meyer Frank, tailor, house 120 South avenue
 Meyer Frank A. house 15 St. Joseph
 Meyer Frank J. hair dresser, Whitcomb House, house 202 North [Whitney
 Meyer Frederick, painter, boards Lyell near
 Meyer Frederick, laborer, house Park av. near Bowen [bds. do.
 Meyer Frederick, sausage maker, 45 Front,
 Meyer Frederick, brewer, 110 Hudson, b. do.

Meyer Frederick W. moulder, 8 Hill, house 4 Delevan
 Meyer Frena, widow, house 31 Wilder
 Meyer George, potter, boards 150 S. St. Paul
 Meyer George, carpenter, h. 120 W. Maple
 Meyer George, h. 23 North York n. railroad
 Meyer Geo. milkman, h. Cottage c. Seward
 Meyer George, cabinet maker, 184 State, h. 1 Anson park [Edinburgh
 Meyer George E. (*J. Meyer & Son*), boards 42
 Meyer George P. & Co. (*A. J. Scheuer and H. H. Schleber*), shoe manufs. River near North St. Paul, boards 48 Broadway
 Meyer Gottlieb, tinsmith, 205 N. Clinton, h. Almira n. Lowell
 Meyer Henry, house 60 Ontario [94 Kelly
 Meyer Henry J. shoemaker, 91 N. Water, b.
 Meyer Henry S. clothier, Pinnacle av. corner Munger, house do.
 Meyer Herman, carpenter, house 60 Ontario
 Meyer John & Son (*George E. Meyer*), grocers, 88 Plymouth av. house 42 Edinburgh
 Meyer John, painter, boards 32 West Maple
 Meyer John, laborer, h. First av. near Bay
 Meyer John, laborer, boards 23 North York
 Meyer John, tailor, h. St. Joseph n. Clifford
 Meyer John, tailor, house 91 Hunter
 Meyer John, painter, boards 15 St. Joseph
 Meyer John, blacksmith, house 63 Frances
 Meyer John, sashmaker, 13 Warehouse, h. 31 McDonald avenue
 Meyer John A. boatbuilder, h. 59 Alexander
 Meyer John B. printer, boards 17 Gibbs
 Meyer John F. lastmaker, Shawmut bldg. h. 53 Lowell
 Meyer John H. shoemaker, house 43 Hudson
 Meyer John H. removed to Florida
 Meyer John H. A. cigar maker, h. 129 Scio
 Meyer John T. machinist, Brown cor. Jones, house Railroad alley near R. R.
 Meyer Joseph, mason, house 120 Chatham
 Meyer Joseph, clerk, boards 47 Andrews
 Meyer Joseph, clerk, house 31 McDonald av.
 Meyer Joseph, cabinet maker, 184 State, bds. 1 Anson park
 Meyer Joseph, carpenter, house 43 Weld
 Meyer Joseph A. carver, Jay cor. Erie canal, house 12 Mauder's park
 Meyer Lawrence S. pressman, 3 West Main, house 309 State
 Meyer Leopold, laborer, house 13 Clifford
 Meyer Louis, cigarmaker, 178 W. Main, bds. 1 Granger
 Meyer Louis, peddler, house 54 Chatham
 Meyer Louis, shoemaker, boards 148 Scio
 Meyer Louis P. grocer, Alexander c. Broadway, boards 48 Broadway
 Meyer Louisa, millinery, 280 N. Clinton, h. do.
 Meyer Margaret M. widow, house 17 Gibbs
 Meyer Martin, tailor, house 200 N. Clinton
 Meyer Martin P. pressman, 3 West Main, h. 31 Stillson
 Meyer Matthias, maltster, house 41 Lowell
 Meyer Mary, tailoress, boards 200 N. Clinton
 Meyer Marx W. peddler, b. 144 Pinnacle av.
 Meyer Morris M. clerk, 106 State, b. 1 Granger
 Meyer Paul, teamster, 106 Lake av. house 5 Vernon

Meyer Philip J. boatbuilder, 41 Broadway, and (*Bentley, Meyer & Southwick*), house 48 Broadway
 Meyer Rosa, Mrs. house 12 Pitt
 Meyer Safara, boatbuilder, house 86 Meigs
 Meyer Samuel & Son (*B. Meyer*), clothiers, 36 West Main, house 47 Andrews
 Meyer Sebastian, shoemaker, 79 N. Water, house 32 West Maple [Oakman
 Meyer Simon, machinist, 138 Mill, house 28
 Meyer Sophia, widow, boards 20 Delevan
 Meyer Sophia, widow, house 148 Scio
 Meyer Theobald (*M. Garson & Co.*), 16 West Main, house at Buffalo [94 Kelly
 Meyer Wm. last maker, Shawmut bldg. bds.
 Meyer William, frame maker, boards 31 McDonald avenue
 Meyer Wolf, peddler, house 1 Granger
 Meyer & Loebbs (*Christian Meyer and Frederick Loebbs*), brewers, 110 Hudson
 Meyer, see Meyers, Myers, Mayer and Meier
 Meyerhoff George, market, Spencer corner Saratoga av. house do.
 Meyering Benjamin, laborer, bds. 53 Joiner
 Meyering Charles F. music teacher, 88 North St. Paul, bds. do.
 Meyering Frederick W. saloon, 88 N. St. Paul, house do.
 Meyering Herman, musician, h. 53 Joiner
 Meyering John, musician, h. 6 McDonald av.
 Meyering Reinhart, lithographer, 7 Market, boards 6 McDonald avenue
 Meyers Adam, laborer, house Sellinger near St. Joseph [1 Granger
 Meyers Benjamin, cigar maker, 3 Eagle, bds.
 Meyers Charles, clerk, 130 Hudson, house Goodman near Bay [Hudson
 Meyers Conrad, driver, house r. Clifford near
 Meyers Frank, glassblower, 178 Plymouth av. house 69 Bartlett
 Meyers Fred W. shoe treer, 81 North Water, b. 93 North av.
 Meyers Henry, laborer, h. 317 N. St. Paul
 Meyers Joseph, glassblower, 178 Plymouth avenue, house 69 Bartlett
 Meyers Margaret, widow, house 142 Cady
 Meyers Morris, bookkeeper, 70 Mill, bds. 54 Chatham
 Meyers Richard, porter, Mill cor. Mumford, house Cottage near canal
 Meyers Wm. glassblower, 178 Plymouth av. boards 130 Caledonia avenue
 Meyers, see Meyer, Myers, Meier and Mayer
 Meyn Herman, coach trimmer, 3 Canal, bds. 94 Strong
 Meyn Louis, deceased May 11, 1876
 Meyn Robert, removed to Constantine, Mich.
 Miannay Eugene, removed to N. Y. city
 Micelli Frank, mason, house 40 N. Frances
 Michaels Adolph, cigar manuf. 33 Monroe av. house do.
 Michaels Ann Mrs. boards 13 Elizabeth pl.
 Michaels Charles F. carpenter, h. 13 Morris
 Michaels Frederick, sawyer, h. Norton near North St. Paul
 Michaels Henry jr. clerk, 70 Mill, b. N. Clinton
 Michaels Henry & Co. (*J. & M. Michaels*), clothiers, 70 Mill, house 34 N. Clinton

- Michaels Henry, bookkeeper, 81 East Main, house 18 Galusha
 Michaels John F. C. carpenter, b. 13 Morris
 Michaels Joseph (*H. Michaels & Co.*), 70 Mill, house 11 East avenue
 Michaels Julius, carver, 155 North Water, house 81 Orchard
 Michaels Marcus (*H. Michaels & Co.*), 70 Mill, boards 34 North Clinton
 Michaels Mary, widow, boards 13 Morris
 Michaels William, removed from city
 Michel Amandus, carpenter, h. 81 Pinnacle av.
 Michel Charles, laborer, Brown corner Jones, boards 81 Orchard
MICHEL FREDERICK P. machinist and machinists' tool manufacturer, Mill foot of Platt, house 63 Platt.—*See page 685*
 Michel George J. machinist, Mill foot Platt, boards 137 Jay
 Michel Henry G. sawyer, boards 119 Meigs
 Michel John, cabinetmaker, bds. 119 Meigs
 Michel Michael, machinist, Mill foot Platt, house 137 Jay
 Michel Ulrich, carriagemaker, bds. 71 Allen
 Michel Victor, teamster, house 119 Meigs
 Michelsen Frederick, fancy goods, 51 North Clinton, house do. [40 Lowell
 Michelsen Paul (*Michelsen & Ruckdeschel*), h. **MICHELSEN & RUCKDESCHEL (P. Michelsen and F. Ruckdeschel)**, furniture manufacturers, foot Mill.—*See page 624*
 Michelson Charles, cabinetmaker, Hydraulic buildings, house 14 Catharine
 Michelson Havilla, laborer, house 62 Martin
 Michelson Henry, cabinetmaker, Hydraulic buildings, boards 40 Lowell
 Mickle William & Co. cigar manufs. 178 W. Main, house 89 East avenue
 Middlebrook Melissa, widow, b. 43 S. Union
 Middleton George E. clerk, 45 Andrews, bds. 266 North St. Paul
 Middleton James, farmer, h. 266 N. St. Paul
 Miedl Emeram, laborer, h. Wilder c. Whitney
 Miedl Magdalena, widow, h. 139 W. Maple
 Mielander Christopher, mason, house 21 Terry
 Mielert Julia, widow, boards 38 Saxton
 Mielke Augusta, widow, house 31 Baden
 Mielke Edward, boxmaker, foot of Centre, boards 15 Hand
 Mielke Henry W. E. carriagemaker, 157 W. Main, boards 15 Hand
 Mier Gustav, laborer, house 15 Hoeltzer
 Milander Caspar, carpenter, bds. 28 Hanover
 Milander Jacob, carpenter, house 28 Hanover
 Milander William, stovemounter, 187 West Main, boards 28 Hanover [Bolivar
 Milburn Thomas, brass moulder, boards 54
 Milburn William H. pattern maker, Brown's race near Furnace, boards 54 Bolivar
 Mildanburger Anton, photographer, boards Hoelfer near St. Joseph
 Mildahn Charles, laborer, house 46 Sellinger
 Mildahn Christian, brakeman, h. 84 W. Maple
 Mildahn Jacob, laborer, house 46 Baden
 Mildahn John, peddler, house 1 Wadsworth
 Mildahn William J. cabinetmaker, 2 Hill, h. 6 Wadsworth
 Miles Bridget, boards 16 Platt
 Miles Catharine, widow, boards 16 Platt
 Miles Edward H. conductor, Erie Railway
 Miles Emmert W. sash and blinds, boards 21 North Clinton
 Miles Eugene S. shoecutter, bds. 52 Marshall
MILES FRANK, carpenter and contractor, Minerva alley, bds. 197 Powers' bldgs.—*See page 632*
 Miles Henry, cartman, h. 18 Johnston's block
MILES HENRY & CO. (Wm. R. Warren), junk dealers, 83 S. St. Paul, house 95 do.—*See page 669*
 Miles John, moulder, house 16 Platt
 Miles Lewis, deputy sheriff, Court House, h. 52 Marshall
 Miles Richard, collarmaker, 129 State, bds. 17 Frank [University av.
 Miles Samuel A. brush manuf. house 137
 Miles Sarah L. widow, house 18 Charlotte
 Miles Susan, widow, h. 99 South St. Paul
 Miles William E. (*Horcheler & Miles*), Aqueduct, bds. 21 North Clinton
 Miles, see Myles
 Milford Amanda M. widow, bds. 4 Garden
 Millard David F. carpenter, h. 2 Fullam's pk.
 Millard De Roy, clerk, 36 State, house 68 S. Union
 Miller Abel, truckman, house 108 Adams
 Miller Addie A. Mrs. hairworker, h. Lake avenue cor. Rowe
 Miller Albert A. engineer, Vacuum Oil Works, house Mansion n. Flint
 Miller Albert F. shoepacker, 55 Mill, boards 81 Cypress
 Miller Aldo, removed from city
 Miller Alexander W. house 11 East
 Miller Amos O. boatbuilder, h. 32 Comfort
 Miller Andrew, shoemaker, h. 236 N. Clinton
 Miller Andrew, cabinetmaker, 2 Hill, house 11 Saxton
 Miller Andrew, painter, 207 E. Main, boards 190 N. Clinton
 Miller Andrew J. shoemaker, 144 N. St. Paul, house 16 Evergreen
 Miller August, laborer, Oak n. Smith, house 136 Oak
 Miller Augusta Mrs. dressmaker, b. 9 Terry
 Miller Augustus, milk, house 100 North av.
 Miller Barbara, widow, boards 32 Kent
 Miller Benedict, carpenter, h. Mt. Vernon avenue n. Cayuga place
 Miller Benjamin W. saloon, 27 W. Main, h. 71 East avenue
 Miller Caspar, butcher, boards 142 Lake av.
 Miller Charles, butcher, h. Lowell c. Cole
 Miller Charles, stonecutter, 54 Fitzhugh, b. 65 Cypress
 Miller Charles, shoemaker, house 43 Smith
 Miller Charles, tool handler, Mill, h. 9 Almira
 Miller Charles, grocer, Campbell c. Orchard, house do. [cor. Orchard
 Miller Charles jr. cabinetmaker, b. Campbell
 Miller Charles jr. shoemaker, bds. 43 Smith
 Miller Charles A. boilermaker, Platt n. Jones, boards 61 Jay
 Miller Charles A. carpenter, house First av. near Pennsylvania av.
 Miller Charles G. boards 29 Frank

HENRY C. WISNER,

**CUT AND PRESSED GLASS TABLE WARE,
 No. 33 STATE STREET.**

Miller Chester, coachmaker, boards East av. near Goodman

MILLER CHRISTIAN, machinist and model maker, 107 N. Water, house 18 Stillson.—See page 674

Miller Christian, tailor, house 68 Orchard
Miller Christian, mason, house 23 Vienna
Miller Christian jr. boxmaker, Aqueduct, b. 68 Orchard

Miller Christian, machinist, 64 Martin, h. do.
Miller Christian J. mason, house Ulm n. Bay
Miller Clarissa Mrs. house 230 N. Clinton
Miller Clark, removed from city
Miller Clotilda Mrs. boards 5 Marshall
Miller Conrad, mason, house 47 Lowell
Miller C. Henry, boatbuilder, house 2 Mount Vernon avenue [Orchard]

Miller Daniel, painter, bds. Campbell corner
Miller David J. carpenter, 39 South Ford, b. 16 St. Clair

Miller Deitrick, cooper, house 7 Almira
Miller Dora, boards 164 North Clinton
Miller Dorcas, widow, h. 6 Franklin square
Miller Edward, hostler, 83 Front, h. 96 Front
Miller Edward, tailor, boards 84 Chatham
Miller Edward J. boards 9 Rome

MILLER EDWARD T. paper hangings and house decorator, 9 West Main, house .93 Hudson.—See page 623

Miller Elizabeth Mrs. house 111 East Main
Miller Emory S. clerk, Allen corner Oak, boards Franklin near Atwater
Miller Ernest L. trunk maker, foot Rowe, boards 1 Nassau [Howell]

Miller E. Worthington, painter, h. Green n.
Miller Flora, butcher, boards 36 Gregory
Miller Frank, tailor, house 62 Saxton
Miller Frank, laborer, 66 West Main, house 30 Wadsworth

Miller Frank, coachmaker, 3 Canal, house 11 Wilder [bds. 65 Cypress]

Miller Frank J. stonecutter, 54 Fitzhugh,
Miller Frederick, brewer, 106 Lake avenue, house 98 do.

Miller Frederick, shoemaker, bds. 43 Smith
Miller Frederick, laborer, house 77 Munger
Miller Frederick J. brewer, 106 Lake avenue, boards 104 do.

MILLER FRED. J. bottler, 1 North av. boards 33 Gibbs.—See page 563

Miller George, mason, h. 147 Pinnacle av.
Miller George jr. harnessmaker, boards 147 Pinnacle av. [h. 146 do.]

Miller George, glassblower, 178 Plymouth av.
Miller George, laborer, h. Terry near Brown
Miller George, cabinet maker, 7 N. Water, house 174 North

Miller George, laborer, h. 22 Oakland park
Miller George, shoemaker, 37 Hand, h. do.

Miller George A. porter, 10 Exchange, house 23 Kent [ers' bldgs. h. 49 Adams]

Miller George A. (*J. C. Miller & Son*), 39 Powell
Miller George E. janitor, 61 Front, house 7 Vought [Saxton]

Miller George J. cabinet maker, boards 11
Miller G. Bayard, nursery agent, boards 32 South Clinton

Miller Happelonia, widow, house 7 Mathews

Miller Harriet A. widow, boards 37 Glasgow
Miller Harry C. blacksmith, bds. 7 Mathews

Miller Helen, widow, house 120 East av.
Miller Henry, blacksmith, Charlotte Junction, house 97 Childs

Miller Henry, combmaker, boards 53 Kirk
Miller Henry, fancy goods, 35 North av. h. do.
Miller Henry, moulder, 187 W. Main, house Miller near Bay [34 Hudson]

Miller Henry A. fireman, N. Y. C. R. R. b.
Miller Henry A. boatbuilder, boards Mt. Vernon near Caroline

Miller Henry O. agent, h. Lake av. c. Rowe
Miller Henry S. moulder, boards 92 Adams
Miller Henry S. dentist, 25 Fitzhugh, h. do.
Miller H. Edward, conductor, N. Y. C. R. R. b. 106 University avenue [2 Widman]

Miller Isaac, cigarmaker, Mill c. Factory, h.
Miller Jacob, laborer, house 61 Kirk
Miller Jacob, carriage painter, 3 Canal, house 13 Wilder

Miller Jacob, clerk, 6 S. St. Paul, b. 78 Jay
Miller Jacob, maltster, 106 Lake av. b. 102 do.
Miller Jacob J. laborer, house 81 Cypress
Miller Jacob P. moulding maker, h. Ames near Jay

Miller James H. lather, boards 20 John
Miller James V. machinist, house 49 Weld
Miller Jesse R. fireman, N. Y. C. R. R. h. Foehner near North

Miller Johanna, widow, house 1 Nassau
Miller John, lastmaker, Shawmut building, house 18 Jay

Miller John, driver, boards 22 Monroe av.
Miller John, painter, house 19 Joiner
Miller John, laborer, boards 45 South av.

Miller John, engineer, 8 Hill, house 175 Pinnacle avenue [bds. 78 Jay]

Miller John jr. cigar maker, Mill c. Factory,
Miller John, waiter, 7 S. St. Paul, house rear 152 North avenue

Miller John, boilermaker, Platt, h. 78 Jay
Miller John, laborer, house Allmeroth near Henrietta avenue

Miller John, spinner, h. Orchard c. Campbell
Miller John jr. removed to Los Angeles, Cal.
Miller John, coachman, 34 Spring, boards 66 Adams

Miller John, cooper, house 53 North avenue
Miller John, blacksmith, house 48 Sherman
Miller John, foreman, Rochester Axle Co. 154 N. Water, house 8 University av.

Miller John A. (*Miller & VanSchuyver*), 147 W. Main, h. 16 St. Clair

Miller John B. engineer, 3 W. Main, house 61 South avenue

Miller John C. carpenter, 9 West Main, bds. 102½ Scio [St. Paul, b. 171½ E. Main]

Miller John G. physician, Franklin c. North

MILLER JOHN H. merchant tailor, 6 Exchange pl. b. Congress Hall.—See p. 536

Miller John H. painter, h. 27 Brown's alley
Miller John I. repairer, house r. 30 Hebard

Miller John M. clerk, 54 ½ Tate, b. 81 Cypress
Miller John S. painter, house 4 Marshall

Miller John W. fresco decorator, h. 35 State
Miller Joseph, mason, house 23 Oakman

Miller Joseph, shoemaker, house 113 Hunter

Miller Joseph, teamster, house Cypress near Mt. Hope avenue
 Miller Joseph, laborer, boards 9 Almira
 Miller Joseph, carriage painter, 3 Canal, bds. Orchard cor. Campbell [1 Cole
 Miller Joseph, cooper, 5 Thompson, house
 Miller Joseph B. machinist, Brown c. Jones, house 331 Brown
 Miller Joseph B. canvasser, 3 W. Main
 Miller Joseph C. laborer, boards 77 Munger
 Miller Joseph S. carpenter, Jones av. c. Saratoga avenue, h. 32 Kent alley
 Miller Josiah C. & Son (*G. A. Miller*), insurance, 39 Powers' bldgs. h. 28 Fitzhugh
 Miller Justine Mrs. house Lyell n. Whitney
 Miller J. Wm. clerk, 42 State, b. 108 Adams
 Miller Katharina, widow, house 65 Cypress
 Miller Kunigunda Mrs. boards 142 Cady
 Miller Lena, domestic, boards 39 N. St. Paul
 Miller Leonard, sawyer, boards Ames n. Jay
 Miller Letitia, dressmaker, bds. 33 Atwater
 Miller Lewis W. mason, house 15 Wilson
 Miller Louis, tailor, 49 Front, boards do.
 Miller Louis, house 114 North avenue
 Miller Louis, umbrella maker, h. 41 Joiner
 Miller Louisa, tailoress, boards Rohr n. Bay
 Miller Lucas, shoemaker, house 326 Brown
 Miller Margaret, widow, house 113 Hunter
 Miller Mary, dry goods, 53 North av. h. do.
 Miller Mary, domestic, 88 Frank
 Miller Mary Miss, vestmaker, bds. 53 Hunter
 Miller Mary A. widow, house 21 Monroe av.
 Miller Mary F. housekeeper, 26 Pearl
 Miller Matthew, carpenter, 100 S. St. Paul, house 67 Munger
 Miller Matthew, butcher, house 101 Cady
 Miller Michael, laborer, house 40 German
 Miller Michael, mason, h. Alphonse n. Hudson
 Miller Mira E. widow, boards 66 S. St. Paul
 Miller Morris Mrs. removed to Germany
 Miller Nellie Mrs. house 63 Prospect
 Miller Nicholas, machinist, bds. 326 Brown
 Miller Nicholas, upholsterer, h. 60 Nassau
 Miller Nicholas, upholsterer, 15 N. Water, house 20 do.
 Miller Paul, painter, 5 S. St. Paul, boards Front c. Mumford
 Miller Pelinah L. widow, bds. 46 Lake av.
 Miller Peter, deceased June, 1875
 Miller Peter, cooper, 154 Lyell, house do.
 Miller Peter, wood yard, 108 North av. h. do.
 Miller Peter G. hairdresser, 58 Lyell, b. 154 do.
 Miller Peter J. hairdresser, 130 N. St. Paul, boards 326 Brown
 Miller Philip, shoemaker, house 38 German
 Miller Philip, lampmaker, boards Orchard corner Campbell [32 Kent
 Miller Philip S. harness maker, 121 State, b.
 Miller Ransom H. house 249 N. St. Paul
 Miller Raymond, spinner, boards Orchard corner Campbell [Paul, h. do.
 Miller Remi, grocer, Atwater corner N. St.
 Miller Richard H. house 20 John
 Miller Robert, house 148 Wilder
 Miller Rudolph D. moulder, 187 West Main, house Foehner n. North [Alexander
 Miller Samuel, moulder, 187 W. Main, h. 19
 Miller Sidney B. tanner, house 98 Pearl

Miller Stephen, clerk, 53 East Main, boards Clinton Hotel [h. 100 Meigs
 Miller Stephen N. foreman, 71 N. St. Paul,
 Miller Stephen O. laborer, h. Saxe n. Clifton
 Miller Theodore H. paper hanger, house 110 Thomas
 Miller Theresa, widow, boards North York
 Miller Thomas O. clerk, 13 E. Main, boards 108 Adams [Violetta
 Miller Truman E. mason, house Mansion n.
 Miller Ursula, widow, boards Ames near Jay
 Miller Walter & Son (*W. Miller jr.*) hairdressers, 6 Mumford, house 33 Atwater
 Miller Walter jr. (*W. Miller & Son*), boards 33 Atwater [9 Terry
 Miller Webster, policeman, City Hall, house
 Miller William (*E. S. Ettenheimer & Co.*), 2 State, boards National Hotel
 Miller William, carpenter, h. 18 Manhattan
 Miller William, laborer, b. 140 Plymouth av.
 Miller William, brewer, 58 North av. h. do.
 Miller William J. hairdresser, 112 Caledonia avenue, house 128 Adams
MILLER & VAN SCHUYVER (*J. A. Miller and A. Van Schuyver*), carpenters, 147 W. Main.—See page 590
 Miller, see Muller and Mueller
 Millett Clement, mason, house 30 Lake av.
 Millett Richard H. blacksmith, 3 Canal, bds. 95 Jay
 Milletts George W. laborer, house 15 Spring
 Millhouse Joseph J. cutter, 14 Mumford, h. 160 North St. Paul [h. 64 Manhattan
 Millichamp Joseph, carpenter, 97 Exchange,
 Millichamp Joseph jr. turner, house 104 Fulton avenue [Hudson
 Millichamp Stephen W. painter, house 153
 Milligan Andrew, laborer, Flour City Mills, house 44 Wilder
 Milligan Andrew jr. laborer, bds. 44 Wilder
 Milligan Martha Miss, house 72 Monroe av.
 Milligan Morris, conductor, N. Y. C. R. R. house 7 Hope [Water, h. 186 Scio
 Milligan William, foreman, River cor. North Milliken W. D. agent, 85 Front, h. at Holley
 Milliman James W. brakeman, Erie Railway, boards 164 Exchange
 Milliman John E. brakeman, Erie Railway, house 164 Exchange
 Milliman Henry C. student, b. 12 Broadway
 Milliman N. Irving, brakeman, Erie Railway, house 164 Exchange
 Milliman Rowland, house 85 East avenue
 Millington Edward J. clerk, 6 Exchange, b. 98 Caledonia avenue
 Millington Helen E. Mrs. boards 36 Sophia
 Millington Henry P. (*Millington & Thomas*), boards 98 Caledonia avenue
 Millington Samuel A. (*Millington & Thomas*), house 98 Caledonia avenue
 Millington Samuel A. jr. sign painter, 21 Smith's block, boards 14 Trowbridge
MILLINGTON & THOMAS (*S. A. Millington, B. F. Thomas and H. P. Millington*), coppersmiths, 2 Ely.—See page 674
 Millman Samuel, confectioner, East Main corner North avenue, house 18 Elm
 Millner Adelbert, engineer, b. 22 Alexander

- Millner Arthur, switchman, b. 22 Alexander
 Millner Catharine A. Mrs. h. 22 Alexander
 Mills Alexander, farmer, house rear Genesee
 near Magnolia
 Mills A. S. boards Waverley House
 Mills Bruce, brakeman, boards 173 North
 Mills Charles, dentist, 11 Masonic block, h.
 116 Monroe avenue [h. 36 Vienna
 Mills Charles A. carpenter, Brown c. Jones,
 Mills Charles J. real estate, house 63 Fulton
 avenue corner Emerson
 Mills Charles M. salesman, 73 East Main,
 boards 14 Mathews
 Mills Chauncey W. machinist, Brown cor.
 Jones, h. 33 Brown [48 Troup
 Mills Cyrus V. N. salesman, 91 State, house
 Mills George, salesman, 53 East Main, boards
 Clinton Hotel [h. 79 Magne
 Mills Henry R. blacksmith, Brown c. Jones,
 Mills Jane, widow, house 75 West avenue
 Mills Margaret, dressmaker, 137 East Main,
 house do. [h. 3 Fitzhugh
 Mills William T. accountant, 22 West Main,
 Mills William H. (*Paine & Mills*), 49 North
 Clinton, house 50 Oakman [h. do.
 Mills William H. hack driver, 15 Fitzhugh,
 Milow Albert C. tinsmith, 29 Exchange, h.
 226 State [Joseph, h. 6 Buchan pk.
 Milow Bernhard L. blacksmith, 170 St.
 Milow Christina, widow, house 5 Jay
 Milow Herman R. furrier, 92 State, b. 5 Jay
 Milow John, laborer, house rear 26 German
 Milson Henry S. deceased Sept. 1875
 Mimmack Charles B. hairdresser, 5 Arcade,
 boards 7 Prospect
 Minch Bartholomew, tailor, house 25 Lewis
 Mine Louis, deceased May 11, 1876
 Minehen Jeremiah, engineer, bds. 22 Romeyn
 Minea Henry, moulder, 20 Court, h. Childs
 near Jay [58 Alexander
 Miner Albert D. salesmon, 14 Front, house
 Miner Oscar D. armorer, N. Y. State Arsenal,
 house 73 South Union
 Minges Balthaser, laborer, house Goodman
 near N. Y. C. R. R. [niture, 6 Front
 Minges Bros. (*J. jr. and J. H. Minges*), fur-
 Minges Catharine, widow, h. 151 St. Joseph
 Minges Frank A. clerk, 165 East Main, bds.
 Goodman near railroad
 Minges Frederick J. grocer, 58 Scio, h. do.
 Minges Fred S. (*Shantz, Minges, Shale & Co.*),
 house East Main cor. Goodman
 Minges Henry, house Goodman near Bay
 Minges Henry C. clerk, 58 Scio, b. 17 Swan
 Minges Henry F. cabinetmaker, h. 9 Asylum
 Minges Jacob, 6 Front, house Goodman near
 railroad [h. 42 South av.
 Minges Jacob jr. (*Minges Bros.*), 6 Front,
 Minges John, grocer, 240 E. Main, house 17
 Swan [Goodman n. Bay
 Minges John F. plumber, 96 East Main, bds.
 Minges John H. (*Minges Bros.*), 6 Front, h. do.
 Minges John L. pressman, boards 17 Swan
 Minges Joseph A. polisher, 38 Gorham, h.
 3 Ringelstein alley
 Minges Mary, widow, bds. East Main corner
 Goodman
 Minges Mary A. boards 151 St. Joseph
- Minges Minnie, milliner, 152 N. Clinton, b.
 17 Swan [house do.
 Minges Simon, boots and shoes, 30 Franklin,
 Minges Sophia C. hair work, 17 Swan, b. do.
 Minges Valentine, polisher, h. 148 St. Joseph
 Minguus Frank, brakeman, Erie railway, h.
 9 Eagle
 Mink Elizabeth, widow, house 14 Grand
 Mink Ezra, veterinarian, 14 Spring, house 4½
 Charlotte [Charlotte
 Mink William H. clerk, 14 Spring, bds. 4½
 Mink, see Meink [near Jay
 Minnan Henry, moulder, 20 Court, h. Childs
 Minnicks William, waiter, Osburn House,
 house 35 Fulton avenue
 Minnis Robert, plumber, h. 2 Johnson park
 Minor Curtis J. foreman, Mill cor. Factory,
 house 19 Jones
 Minot Jonathan, removed from city
 Minot Morton, student, University of Roch-
 ester, boards 35 Howell
 Minouge Patrick J. fireman, N. Y. C. R. R.
 house 18 Smith
 Minsky Joseph, peddler, house 41 Joiner
 Mintonye Caroline H. widow, boards 16
 Chestnut park
 Mirguet Charles, saloon, 51 Front, house do.
 Misfeld Charles, laborer, boards 49 Hoeltzer
 Misfeld John, boot crimper, 87 Front, house
 15 Maria
 Misfeld John E. laborer, house 49 Hoeltzer
 Misfeld Louis, laborer, house 49 Hoeltzer
 Misler Jacob, laborer, 138 Oak, h. Wilder n.
 Childs [Pinnacle avenue
 Misler Louis, harnessmaker, 121 State, b. 182
 Mitchell Adelia C. widow, b. 60 South av.
 Mitchell A. M. Mrs. matron Church Home,
 126 Mt. Hope av.
 Mitchell Barrett B. accountant, 14 Exchange,
 boards 27 North St. Paul [at Utica
 Mitchell B. T. salesman, 91 N. Water, house
 Mitchell Cecilia M. widow, h. 13 Park av.
 Mitchell Charles, laborer, 16 S. St. Paul, h.
 rear 49 Savannah [45 Cheney
 Mitchell Charles, cutter, 73 East Main, h.
 Mitchell Frank B. furfumer, h. 13 Park av.
 Mitchell George, bricklayer, h. 45 Prospect
 Mitchell George, laborer, house 146 Lewis
 Mitchell George N. h. W. Troup c. Frances
 Mitchell John, policeman, City Hall, boards
 5 Franklin square
 Mitchell John, machinist, 122 Mill, h. 1½ Jay
 Mitchell John C. optician, 179 North St.
 Paul, boards Draper near Concord av.
 Mitchell John H. carpenter, b. 24 Upton pk.
 Mitchell J. Guernsey, sculptor, b. 13 Park av.
 Mitchell Lou Miss, seamstress, b. 20 Cham-
 plain [Concord avenue
 Mitchell Margaret, widow, house Draper n.
 Mitchell Mary J. h. r. Stone n. Allen's alley
 Mitchell Michael H. tallyman, Platt corner
 Kent, house West Maple near Ames
 Mitchell Stephen C. boxmaker, foot Centre,
 boards Draper near Concord avenue
 Mitchell Thomas, laborer, house Reynolds
 near Flint
 Mitchell Thomas, carpenter, rear 220 State,
 house 25 Saxton

Mitchell Thomas W. upholster, 7 N. Water, h. Reynolds n. Flint [c. State
 Mitchell Wm. grocer, 232 State, h. Factory
 Mitchell William, laborer, boards 5 Putnam
 Mitchell W. Gayord, clerk, Post Office, b. 13 Park avenue [the tollgate
 Mitkiewicz Eugene, Count, h. Lake av. near
 Mittenhal Joseph, peddler, house 19 Pryor
 Mittil Sebastian, stone mason, h. 45 Seward
 Mitzky Charles, clerk, 62 State, h. 16 Pearl
 Mix Ellen Mrs. widow, house 11 South Ford
 Mix Emmett H. carpenter, b. 11 South Ford
 Mix George W. photographer, b. 12 Foehner
 Mix John, cutter, house 12 Foehner
 Mixer Albert H. prof. University of Rochester, house 9 Chestnut
 Mixer Byron S. (*A. E. Dumble & Co.*), 44 State, boards Whitcomb House
 Mizler Jacob, yardman, house 137 Wilder
MOCK ALBERT, millinery goods, 52 State, h. 43 North av.—*See page 545*
 Mock Frederick, salesman, 72 Mill, boards 55 North avenue
 Mock Isaac, clerk, 52 State, b. 43 North av.
 Mock Jacob, boards City Hospital
 Mock Louis, boards Whitcomb House
 Mock Max (*Rosenthal, Cauffman & Co.*), 72 Mill, house 74 Franklin
 Moderi August, carpenter, house 55 Hanover
 Moehling Charles F. cabinetmaker, boards 26 Magne [Joseph, house 41 Delevan
 Moehling Charles L. carpenter, 14 St.
 Moehling Gottlieb, cabinetmaker, house 26 Magne [Joseph
 Moerdyke Abram, finisher, b. Clifford n. St.
 Moerdyke Cornelius, scroll sawyer, boards Clifford near St. Joseph
 Moerdyke Josiah, carpenter, 5 Andrews, h. Clifford near St. Joseph [103 Court
 Moerel Emanuel M. clothing, 46 Front, bds.
 Moeschler Ernst L. rubber worker, 141 N. Water, house Goodman near Bay
 Moffet Eleanor, widow, house 5 Stone
 Moffet Jennie, tailoress, b. 46 Oakland park
 Moffet Mellnot T. I. laborer, boards 5 Stone
 Moffitt James, laborer, h. 65 Monroe avenue
 Moffitt Delia Mrs. grocer, 226 State, h. do.
 Moffitt William H. porter, house 226 State
 Mogler Charles, pressman, 23 W. Main, h. rear 36½ Gregory
 Mogler William, mason, house 70 Sanford
 Mogler William, piano maker, b. 70 Sanford
MOGGRIDGE JOHN, grocer and market, Spring c. Plymouth av. h. 38 Plymouth avenue.—*See page 575*
 Mogridge William A. bookkeeper, 23 Spring, house 8 Eagle
 Mohen Thomas, laborer, house 13 Otsego
 Mohr George, bootmaker, 75 N. Water, h. 58 Herman [Scio
 Mohr Louis, blacksmith, Platt c. Kent, h. 24
 Mohr Henry, shoemaker, b. Hollenbeck near avenue D [avenue D
 Mohr Peter, tanner, house Hollenbeck near
 Mohr Peter jr. shoemaker, 92 State, boards Hollenbeck near avenue D
 Mohr Philip, varnisher, 73 State, h. North Clinton near Vernon park

Molamphy Patrick, brewer, Atwater cor N. St. Paul, boards 37 Platt
 Moldan James, baggageman, Erie railway, house 6 Edinburgh [St. Paul
 Moldenhauer Charles, laborer, boards 171 N.
 Moler Wm. laborer, house Bay n. Goodman
 Molk Henry, laborer, house 119 Saxton
 Mollett John, shoemaker, h. 66 Exchange
 Moll Frederica, widow, h. North av. n. Bay
 Moll Frederick, cutter, 24 State, house 35 Gregory
 Molloy John, repairer, 7 Arcade, boards 18 Market
 Molon Kate, dressmaker, b. 12 Tremont pl.
 Moloney Edward A. telegrapher, boards 23 Bolivar
 Moloney Frank, clerk, boards 24 Centre
 Moloney Michael, carpenter, Brown c. Jones, house 71 Lyell
 Molt Lena Mrs. house 1 Clinton place
 Molz John, moulder, 145 N. Water, house 34 Kirk [do.
 Monaghan Agnes, dressmaker, 6 Mortimer, b.
 Monaghan Anna, widow, house 93 Cypress
 Monaghan Bridget, widow, h. 58 Chatham
 Monaghan Charles J. cashier, b. 16 Spencer
 Monaghan David, policeman, City Hall, h. 16 Spencer [c. Lorimer
 Monaghan David D. student, bds. Thompson
 Monaghan Edward (*Monaghan & Eustice*), h. 8 Comfort [Spencer
 Monaghan Francis P. machinist, boards 16
 Monaghan James jr. cigarmaker, 9 Caledonia avenue, boards 54 Hunter
 Monaghan James, saloon, house 54 Hunter
 Monaghan John, h. 24 South [av. h. 8 Smith
 Monaghan John jr. blacksmith, 2 Plymouth,
 Monaghan Mary A. milliner, b. 28 Chatham
 Monaghan Mary A. music teacher, boards 6 Mortimer
 Monaghan Mary J. domestic, 14 Ambrose
 Monaghan Michael, millwright, house 91 Monroe avenue
 Monaghan Nellie A. teacher, Whitney School, No. 17, boards 91 Monroe av.
 Monaghan Patrick, deceased December, 1875
 Monaghan Patrick, shoemaker, h. 6 Mortimer
 Monaghan Patrick gas fitter, 25 Exchange, boards 24 South [Mortimer
 Monaghan P. John, framemaker, boards 6
 Monaghan William H. laborer, b. 58 Chatham [*Eustice*], blacksmiths, 9 Division
 Monaghan & Eustice (*E. Monaghan and J. Monahan Dennis*, cartman, h. Childs alley near Erie Canal
 Monell William H. 78 West Troup
 Monell Mrs. widow, boards 78 West Troup
 Monk Wm. & Co. (*H. Stopperan*), saloon, 239 E. Main, h. at Irondequoit [av.
 Monks Richard, nurseryman, h. 6 Anderson
 Monna Justin, hostler, 159 State, house 91 Orange
 Monroe Charles, moulder, boards 85 Tappan
 Monroe County Bible Society, 75 State
MONROE COUNTY SAVINGS BANK, 31 State.—*See page 497*
 Monroe Frank A. student, house 62 Asylum
 Monroe George H. removed to Leroy

- Monroe Isa Miss, teacher, boards 85 Tappan
 Monroe James H. clerk, 17 State, boards
 Chapman House [house do.
 Monroe James S. physician, 27 Sibley's blk.
 Monroe Mary, widow, h. Hudson n. Bernard
 Monroe Mary, widow, house 85 Tappan
 Monroe Peter L. grocer, 53 Frances, h. do.
 Monroe Robert B. stencil cutter, 43 E. Main,
 house 6 Warehouse [house do.
 Monroe S. J. Mrs. physician, 62 Asylum,
 Montgomery Abel S. watchman, 31 State, h.
 28 Spencer [Union
 Montgomery Andrew, peddler, h. 79 South
 Montgomery Ann, widow, house 339 State
 Montgomery Catharine, widow, boards 31
 South St. Paul [Tenth n. R. R.
 Montgomery David, horse dealer, house
 Montgomery David, peddler, h. 119 Univer-
 sity avenue [ner park
 Montgomery Elizabeth Mrs. bds 26 Gardi-
 Montgomery Frederick, painter, h. 72 Mon-
 roe avenue
 Montgomery George B. boards 53 Court
 Montgomery George W. clergyman, h. 30
 Chestnut
 Montgomery Guy R. student, bds. 44 Spring
 Montgomery Harvey F. surgeon and phys-
 ician, 7 Smith's block, house 44 Spring
 Montgomery Henry M. Mrs. boards 29 Allen
 Montgomery James, news agent, N. Y. C.
 R. R.
 Montgomery James H. student, b. 29 Allen
 Montgomery Jane, widow, h. 30 South av.
 Montgomery Jane Miss, boards 9 Tappan
 Montgomery John F. carpenter, 37 Pinnacle
 avenue, house 32 South avenue
 Montgomery Mary Mrs. h. 119 University av.
 Montgomery Mary, widow, b. 3 Livingston
 place [house 341 do.
 Montgomery Robert, hairdresser, 339½ State,
 Montgomery Sarah, widow, b. 68 Chestnut
 Montgomery Sarah Mrs. h. 73 Sibley's block
 Montgomery Sylvia M. widow, h. 20 Frank
 Montgomery Thomas C. lawyer, 75 Powers'
 buildings, house 46 Spring
 Montgomery William A. bookkeeper, 138
 Mill, boards 28 Spencer
- MONTGOMERY WILLIAM H.** manager
 Continental Life Ins. Co. 13 Powers'
 bldgs. h. 3 Livingston pl.—See page 510
 Montgomery William L. chairbottomer, bds.
 339 State
 Moody Chas. H. bookkeeper, Court st. bridge,
 and (Swinburne & Co.), bds. 4 Charlotte
 Moody David, house 23 North Washington
 Moody Horace S. conductor, h. 40 S. Union
 Moody James S. shoemaker, 91 N. Water,
 boards Reed House
 Moody John H. clerk, b. 23 N Washington
 Moody Wm. F. fireman, boards 210 North
 Mooney Fortescue L. bookkeeper, Brackett
 House, house 30 George
 Mooney James, miller, boards 360 Brown
 Mooney John, laborer, boards 1 Summer al
 Mooney John B. grocer, 216 State, house 54
 Charlotte
 Mooney Margaret, widow, house 89 Hunter
 Mooney Mary J. Mrs. house 106½ West Main
- Mooney Michael, shoemaker, 162 State, h.
 360 Brown [134 University av.
 Mooney Peter, porter, Osburn House, house
 Mooney Peter, laborer, Erie freight depot,
 house Cottage near Plymouth avenue
 Mooney Thomas, tinsmith, bds. 360 Brown
 Mooney William, harness maker, 25 S. St.
 Paul, house 58 Chestnut
 Mooney Wm. turner, boards Rowe c. Thorn
 Moore Andrew, carpenter, house 20 Ward
 Moore Ann, widow, house 16 Joiner
 Moore Ann, dressmaker, boards 16 George
 Moore Augusta, stitcher, h. 8 Newton block
 Moore Bridget, widow, house 16 Favor
 Moore Charles, grocer, 57 Hunter, house do.
 Moore Charles, laborer, house Magnolia near
 Genesee
 Moore Charles A. painter, boards 57 Hunter
 Moore Charles E. expressman, h. 15 Green-
 wood avenue
- MOORE CHARLES T.** coffee and teas,
 spices, &c. 14 Front, house 317 State.—
 See page 550
 Moore Clarence, brushmaker, b. 80 Reynolds
 Moore David B. repairer, boards 31 S. Ford
 Moore Edward, laborer, h. Gates av. n. Otis
 Moore Edward M. physician, 63 Fitzhugh,
 house do. [Fitzhugh
 Moore Edward M. jr. physician, boards 63
 Moore Elizabeth A. widow, h. 4 Phelps av.
 Moore Ellen, widow, boards 59 West Maple
 Moore Emma, widow, house 90 Monroe av.
 Moore Eva, widow, house 126 East Main
 Moore Frances, tailoress, 24 Vincent pl. b. do.
 Moore Frederick, carpenter, bds. 8 N. Ford
 Moore George, boards 82 Fitzhugh
 Moore George jr. brushmaker, ft. Aqueduct,
 boards 80 Reynolds
 Moore George H. tailor, house 80 Reynolds
 Moore George W. laborer, bds. 78 Tremont
 Moore Hasseltine S. house 198 Alexander
 Moore Henry, shoemaker, b. Hollenbeck c.
 Dutch
 Moore Henry J. removed to Victor, N. Y.
 Moore James, laborer, h. r. S. St. Paul, n.
 weighlock
 Moore James A. painter, house 13 Grape
 Moore James H. house 74 Herman
 Moore James H. carpenter, bds. 41 Tremont
 Moore Jennie, dressmaker, boards 16 George
 Moore John, chairmaker, lower falls, h. 24
 Vincent place
 Moore John, bartender, boards 4 Smith
 Moore John, laborer, h. Plymouth av. near
 Cottage
 Moore John, agent, boards Waverley House
 Moore John, carpenter, house 39 William
 Moore John C. proprietor Genesee Avenue
 House, 280 N. St. Paul, house do.
- MOORE JOHN C.** bookbinder, 27 Smith's
 block, house 53 Spring cor. Caledonia
 avenue.—See page 519 [36 Saxton
 Moore John C. tinsmith, 244 State, boards
 Moore John H. chairmaker, lower falls, h.
 134 Lake avenue
 Moore John J. marble polisher, 123 W. Main,
 bds. 117½ E. Main
 Moore John O. mason, house 47 Hunter

Moore Joseph H. letter carrier, post office, house 1 Ontario
 Moore Julia, widow, house 16 George
 Moore J. Gilbert, house 113 West avenue
 Moore J. William, insurance agent, 19 Powers' bldgs. house 42 Meigs
 Moore Lewis, laborer, b. 102 Mill [Lyell
 Moore Lewis T. cutter, 91 N. Water, bds. 40
 Moore Lida Miss, house 5 Adams
 Moore Louis W. (*Funkenstein & Moore*), 10 Mill, house 54 Franklin
 Moore Margaret, widow, h. 60 Caledonia av.
 Moore Margaret, widow, house 16 Joiner
 Moore Maria, widow, house 78 Tremont
 Moore Martin V. B. hatter, 2 Mumford, h. 35 Charlotte
 Moore Mary widow, h. Kent al. n. railroad
 Moore Mary, widow, house 82 Fitzhugh
 Moore Mary A. widow, house 31 S. Ford
 Moore Mary B. widow, house 47 Pearl
 Moore Mary J. domestic, bds. 122 Alexander
 Moore Mary J. Mrs. dressmaker, 38½ Fitzhugh, house do.
 Moore Michael, laborer, house 9 Syke
 Moore Orrin W. (*Moore & Mc Nerney*), 60 E. Main, house 8 Mortimer
 Moore Pamela, widow, b. 12 South St. Paul
 Moore Patience, widow, house 11 Sycamore
 Moore Richard M. student, bds. 63 Fitzhugh
 Moore Robert, ticket agent, Erie railway depot, h. 61 Chestnut [b. 16 Favor
 Moore Robert J. boots and shoes, 140 W. Main,
 Moore Samuel, laborer, Platt c. Kent, house 36 Saxton [b. 63 Fitzhugh
 Moore Samuel P. student, 15 Powers' bldgs.
 Moore Samuel S. clothing cleaner, b. 47 Kirk
 Moore Sarah R. widow, h. 132 Monroe av.
 Moore Susan, domestic, b. Goodman n. University avenue
 Moore Thomas, mason, h. Frank c. Brown
 Moore Thomas, clerk, 14 West Main, house 63 Munger
 Moore William, carpenter, boards 205 State
 Moore William, coachman, 45 S. Clinton, h. 33 Broadway [11 Harrison
 Moore William B. carpenter, Minerva al. h.
 Moore William B. jr. shoecutter, 55 Mill, b. 11 Harrison [b. 85 Troup
 Moore Wm. H. (*Moore & Cole*), 72 W. Main,
 Moore William H. tinsmith, 65 Exchange, boards 31 South Ford
 Moore Wm. L. printer, house 25 Meigs
 Moore William R. Mrs. house 47 Kirk
 Moore William T. insurance, 102 E. Main, house 52 Scio

MOORE & COLE (*W. H. Moore and A. H. Cole*), groceries and teas, 72 West Main. —See page 574
MOORE & McNERNEY (*O. W. Moore and A. G. Mc Nerney*), merchant tailors, 60 E. Main.—See page 537
 Moore, see Mohr, Muir and Murr
 Moran Ambrose J. (*Joyce & Moran*), 206 W. Main, house 206½ do. [277 Brown
 Moran Bernard, letter carrier, Post Office, h.
 Moran Catharine, widow, b. 58 Brown blk.
 Moran Daniel, laborer, house 49 Hunter
 Moran Ellen Miss, dressmaker, b. 49 Hunter

Moran Henry, painter, 12 Stone, boards r. South av. near city line
 Moran James, miller, Frankfort Mills, house Whitney n. railroad [15½ S. Clinton
 Moran James (*Moran & Sheil*), 11 Front, h.
 Moran James, laborer, house 72 Smith
 Moran John, cabinetmaker, h. 206½ W. Main
 Moran Joseph H. blacksmith, 90 Front, bds. 63 Lake avenue
 Moran Maggie, clerk, 251 State, b. 49 Hunter
 Moran Margaret, house 67 Frank
 Moran Mary, widow, b. Whitney near R. R.
 Moran Mary J. domestic, Congress Hall, boards do.
 Moran Michael, laborer, house 78 Smith
 Moran Michael, laborer, boards 51 Genesee
 Moran Patrick, blacksmith, 90 Front, house 63 Lake avenue
 Moran Thos. laborer, 43 S. Clinton, bds. do.
 Moran Thos. laborer, house 22 Elizabeth
 Moran Thomas, stove repairer, h. 50 Genesee
 Moran Thomas F. painter, h. r. 61 Prospect
 Moran William, stoves, 108 West Main, house 204 do. [clothing, 11 Front
 Moran & Sheil (*J. Moran and C. Sheil*),
 Morann Mary A. tailoress, bds. 57 Prospect
 Morancie Peter, sawyer, S. St. Paul opp. Griffith, house 96 Pinnacle av. [Henry
 Morath Martin, blacksmith, h. Weegar near
 Mordean Allen H. rem'd to Ontario, Canada
 Mordoff Carlos W. clerk, 87 E. Main, bds. 180 State [bds. 87 Lake av.
 Mordoff Chas. H. bookkeeper, State c. Platt,
 Mordoff Hiram E. boards 12 Green
 Mordoff Jane Mrs. boarding house, 180 State, house do.
 Mordoff Maria B. widow, house 12 Green
 Mordoff Mortimer C. (*Chamberlain & Mordoff*), State c. Platt, house 87 Lake av.
 Morehouse Christiana, widow, h. 60 Weld
 Morehouse Emma, widow, bds. 13 S. Union
 Morehouse Henry L. pastor East Avenue Baptist Church, house 13 South Union
 Morehouse James H. laborer, house Plymouth avenue c. Strong
 Morehouse Jane, widow, bds. 8 New York
 Morel Charles, removed to Auburn
 Morey Clarence E. removed to Chili
 Morey James H. house 35 South Ford
 Morey John E., Rochester Union & Advertiser Co. 82 W. Main, h 25 S. Clinton
 Morey John E. jr. collector, 82 W. Main, b. 25 South Clinton
 Morey Robert, boards 37 North St. Paul
 Morey Wm. C. prof. University of Rochester, boards 146 Powers' buildings
 Morfe Geo, carpenter, bds. Sibley n. Culver
 Morgan Ansel A. (*Morgan & Schuyler*), house 9 Prince [Mill, h. do.
 Morgan Catharine (*Collins & Morgan*), 101
 Morgan Ellen, grocer, Tremont n. Canal, house do. [Atkinson
 Morgan Geo. boot cutter, 55 Mill, house 53
 Morgan Geo. R. machinist, bds. 226 State
 Morgan James, laborer, b. Anderson avenue cor. Fairmount
 Morgan James, laborer, boards 31 S. St. Paul
 Morgan James, groom, boards 25 Otsego

HENRY C. WISNER,

WHITE CHINA DINING and TEA SETS, No. 33 STATE STREET.

- Morgan James W. printer, 82 W. Main, bds. 217 Exchange
- Morgan John, foreman, 89 Mill, b. 25 Otsego
- Morgan John S. lawyer, 24 Powers' bldgs. boards 9 Prince [Brisbane]
- Morgan Joseph M. carpenter, house First n.
- Morgan Lemuel S. boards 95 Fitzhugh
- Morgan Lewis H. lawyer, house 95 Fitzhugh
- Morgan Owen, livery stable, 89 Mill, house 25 Otsego [Adams]
- Morgan Robert, foreman, 15 Mill, house 103
- Morgan Sarah J. widow, h. 40 Alexander
- Morgan Thomas, plumber, 65 Exchange, b. 54 Tremont
- Morgan William A. h. 3 Franklin [48 Jones]
- Morgan Wm. J. clerk, 44 Exchange, boards
- Morgan Wm. W. bookkeeper, 8 White, bds. 32 Spencer [house 13 Mortimer]
- Morgan Zachariah, blacksmith, ft. Centre,
- Morgan & Schuyler (A. A. Morgan and B. F. Schuyler), dentists, 55 E. Main
- Morgenroth Sebastian, tailor, 68 Smith's block, h. 9 Wilson [h. 9 Hope]
- Morgenroth Valentine, tailor, 60 Smith's blk.
- Morhardt Fred. market, 196 North Clinton, house do.
- Morhardt John, butcher, bds. 196 N. Clinton
- Moriarty Daniel P. cabinetmaker, 2 Hill, h. 131 N. St. Paul [Stone, bds. 3 South]
- Moriarty Giles D. watchmaker, Court cor.
- Morley Edward, hostler, 24 Greig, house 31 Gregory
- Morley John H. axemaker, boards 48 Jones
- Morley John J. boat captain, h. 27 Fulton av.
- Morley Lewis E. house 46 Griffith
- Morley Mary A. widow, house 25 Reynolds
- Morley William, deceased November, 1875
- Morley Wm. J. cabinet maker, Jay cor. Erie canal, b. 25 Reynolds
- Morlock Christian, cook, house 12 N. Union
- Morlock Christian H. jeweler, 14 State, bds. 12 North Union
- Morphet Ellen, widow, boards 52 Jones
- Morphet Fanny, domestic, 1 Whitney place
- Morphet George, laborer, h. 16½ Spring
- Morphy David, flour, 114 St. Joseph, h. do.
- Morphy John, flour and grain, 230 N. Clinton, house 11 Oakman
- Morphy Robert, clerk, 230 N. Clinton, b. 11 Oakman [S. St. Paul]
- Morrice James C. clerk, 53 E. Main, b. 38
- Morris Andrew, clerk, 47 Front, boards at Irondequoit [at Irondequoit]
- Morris Andrew L. market, 47 Front, house
- Morris Anna Mrs. bds. 71 Sibley's block
- Morris Caroline Mrs. house 80 Exchange
- Morris Charles E. (Merriam & Co.), 40 West Main, house 7 Anson park
- Morris David, fruit dealer, house 93 E. Main
- Morris Deborah, widow, b. 126 Mt. Hope av.
- Morris Elizabeth, widow, house 14 Glasgow
- Morris Elizabeth Mrs. nurse, bds. 4 Foehner
- Morris Helen, widow, house 29 Monroe av.
- Morris Heman W. student, 18 Powers' bldgs. boards 29 South [h. 12 Park avenue]
- Morris Herbert W. pastor Calvary Church,
- Morris Jabez, overseer, Rochester Cotton Mill, boards 38 Platt
- Morris John, fruit dealer, h. 119 St. Joseph
- MORRIS JOHN M.** silver and gold plater, 14 State, h. 63½ Gregory.—See page 514
- Morris John M. jr, silver plater, 14 State, b. 63½ Gregory [h. 4 Foehner]
- Morris Joseph B. painter, 115 S. St. Paul,
- Morris Sarah M. Mrs. confectionery, 93 E. Main, house do.
- Morris Thomas, boards 135 West Main
- Morris Thomas R. clerk, 47 Front, boards at Irondequoit
- Morris Walter, hairdresser, b. 80 Exchange
- Morris William boiler maker, house 95 Jay
- Morrison Alexander, policeman, City Hall, h. 38 Saratoga avenue
- Morrison Bertha Miss, boards 19 Lowell
- Morrison Bessie B. house Rowe cor. Thorn
- Morrison Elizabeth, widow, boards 126 Mt. Hope avenue
- Morrison Ellen Mrs. boards 53 Davis
- Morrison Flora A. nurse, house 8 Vine
- Morrison James, gardener, h. Rowe c. Thorn
- Morrison James, teamster, h. 16 Vincent pl.
- Morrison John, deceased July 19, 1875
- Morrison John, painter, h. St. Clair n. Penn
- Morrison John L. shoe cutter, 15 Mill, boards 9 St. Clair
- Morrison John T. shoemaker, 30 E. Main, h. 13 Linden [Andrews, b. 13 Genesee]
- Morrison Joseph, shoe cutter, N. Water c.
- Morrison Mary, widow, bds. Fulton avenue corner Perkins
- Morrison Richard, tailor, house 19 Lowell
- Morrison Richard jr. shoemaker, 75 North Water, boards 19 Lowell
- Morrison Sarah A. Mrs. house 41 Frank
- Morrison Thomas, laborer, house 15 Martin
- Morrison Thomas W. coroner, 30 East Main, house 101 Mt. Hope av.
- Morrison William F. house 9 Oregon
- Morrison William L. student, b. 9 Oregon
- Morrrough Eliza Mrs. house 46 Joiner
- Morse Adeline, widow, h. 29½ Lancaster
- Morse Albert, tinsmith, boards 115 Tremont
- Morse Ann, widow, house 37 Lancaster
- Morse Asahel B. hod maker, h. 43 Prospect
- Morse Charles C. (Pancost, Sage & Morse), 92 State, house 23 Prince
- Morse Charles E. editor, Evening Express, 23 West Main, bds. 77 North av.
- MORSE CHARLES H.** die sinker and stencil cutter, 69 State, h. 28 Delevan.—See page 625
- Morse Charlotte M. widow, bds. 28 Delevan
- Morse Edward W. clerk, bds. 9 Fulton av.
- Morse Edwin R. conductor, N. Y. C. R. R. house 132 Jones [194 North]
- Morse Eugene T. telegrapher, 151 State, bds.
- Morse Franklin W. (Morse & Chambers), h. 9 Fulton avenue
- Morse George E. sec. and treas. Roch. Insole manufg. Co. 75 N. Water, bds. 27 Pearl
- Morse George P. clerk, 75 N. Water, boards 27 Pearl
- Morse Helen A. teacher, Munger School No. 13, boards 29 Howell
- Morse Henry H. (Woodbury, Morse & Co.), 7 West Main, bds. 23 East avenue

Morse Jane I. widow, house 29 Howell
 Morse Jennie A. teacher, Munger School, No. 13, boards 29 Howell
 Morse John B. foreman, River n. North St. Paul, house 57 Court
 Morse Lewis, lampmaker, bds. 43 Prospect
 Morse Lewis N. clerk, 33 East Main, b. do.
 Morse Mary E. widow, house 15 Arnold pk.
 Morse Millard T. boards 29 Howell
 Morse Mortimer B. engineer, N. Y. C. R. R. house 2 Trowbridge
MORSE WILLIAM B. & Co. (S. G. Hollister), lumber dealers, 30 West av. c. Trowbridge, house 122 West avenue.—
See page 652
 Morse & Chambers (*F. W. Morse and R. W. Chambers*), druggists, 134 State
 Mort John, laborer, house 137 Scio
 Morthorst Henry, blacksmith, N. Y. C. R. R. car shop, house 9 German alley
 Morthorst Henry G. safemaker, 188 State, b. 9 German alley [alley
 Morthorst William, student, house 7 German
 Mortimer Carrie Miss, house 59 N. St. Paul
 Mortimer Edmund, house 3 Cypress
 Morton Charles D. clerk, 270 Plymouth av. boards 274 do.
 Morton George C. salesman, house 29 Court
 Morton Henry, house 141 East Main
MORTON JOHN & CO. (E. Ocumpaugh), clothing, 21 East Main, house 25 Howell.—
See page 539 [Siegel n. Lewis
 Moschcau Charles A. laborer, 50 Exchange, h.
 Moschcau Rudolph, cabinetmaker, 133 N. Water, house Pinnacle avenue
 Moscrip Charles H. student, Rochester Theological Seminary, bds. Trevor Hall
 Moseley Araunah, house 20 Mortimer
MOSELEY H. MONTAGUE & WIGHTMAN (D. A. Wightman), ladies' cloaks, suits and underwear manufs. 7 E. Main, house 127 West av.—*See page 547*
 Moseley Jirah B. (*Moseley & Motley*), house 74 Andrews
MOSELEY & MOTLEY (J. B. Moseley and George Motley), Flour City Mills, Mill near Brown.—*See page 552*
 Mosely David E. house 189 N. Clinton
 Moser Albert, removed to Cleveland, O.
MOSER ALEXANDER M. coal dealer, 117 N. Clinton and 207 South St. Paul, house 62 Chestnut.—*See front cover*
 Moser Delia C. teacher, No. 9, boards 299 North Clinton
 Moser Edward A. clerk, house 82 Kelly
 Moser Emma M. teacher, Hudson School No. 16, boards 299 N. Clinton
 Moser Fred. laborer, house 46 Thomas
 Moser Frederick, flour and feed, 111 North avenue, boards 5 Weld
 Moser Frederick, house 299 North Clinton
 Moser John, laborer, house 6 North Stillson
 Moser John, laborer, boards 2 Union alley
 Moser Mary, widow, house 2 Union Alley
 Moser Sabina, widow, h. Norton n. Carter
 Moses America Miss, house 120 Hudson
 Moses Eliza Miss, house 120 Hudson
 Moses Fred. A. student, boards 29 Chestnut

Moses Mattie A. boards 29 Chestnut
 Moses Schuyler, house 29 Chestnut
 Mosher David, laborer, h. Brighton lock, Erie canal
 Mosher Eugene, agent, boards 7 Madison
 Mosher George A. removed to Wolcott
 Mosher Jane Mrs. boarding, h. 121½ E. Main,
 Mosher John G. maltster, 218 Alexander, h. 155 University avenue
 Mosher Wendell P. telegrapher, b. 7 Madison
 Moshier Franklin, engineer, N. Y. C. R. R. house 32 Adams
 Moshier Isaac V. constable, house 26 Ward
 Mosier William H. laborer, house Glasgow near railroad
 Moss James, teamster, bds. 259 N. St. Paul
 Moss Louisa Miss house 91 Tappan
 Moss William, laborer, h. 311 N. St. Paul
 Most Adam, gardener, house Bay n. North
 Moster William, teacher, bds. 11 East Maple
 Moszgraber Charles, laborer, h. 57 Hudson
 Motley Geo. (*Moseley & Motley*), h. 44 Lake av.
 Motteler Chas. bookbinder, b. 12 N. Clinton
 Mougin Louis, laborer, 8 Hill, h. Jay n. Ames
 Moulson George & Son (*T. G. Moulson*), nurserymen, N. Union n. railroad, house 10 Park avenue
 Moulson Sam'l, soap, 50 Front, h. 22 East av.
 Moulson Thomas, provisions, 112 East Main, house 22 East avenue [h. 10 Park av.
 Moulson Thomas G. (*G. Moulson & Son*),
 Moulton David (*Davis, Moulton & Co.*), 36 Exchange, house at Floyd, N. Y.
 Moulton Geo. H. bartender, 93 E. Main, b. do.
 Moulton Mark, watches, jewelry, etc. 3 Powers' bldgs. house 146 Alexander
 Moulton Mark E. clerk, 3 Powers' bldgs. b. 146 Alexander [near Bay
 Moulton Washington, teamster, h. Third av.
 Mount Charles J. B. bookkeeper, h. 23 South
 Mountain Celia F. dressmaker, bds. 40 Alexander [ander
 Mountain Elizabeth, dressmaker, h. 40 Alexander
 Mountfort Mary, widow, house 12 Delevan
 Mourer Henry, laborer, house 26 Rhine
 Mowry George W. removed to Geneva
 Mowry Maria, widow, bds. 11 Elizabeth
 Moxom Philip S. student, Rochester Theological Seminary, boards Trevor Hall
 Moyer James, agent, 14 Arcade, b. 2 Pleasant
 Moynihan Andrew F. machinist, 106 Mill, b. 30 Hand
 Moynihan Ann, widow, b. 119½ East Main
 Moynihan Cornelius, shoemaker, N. Water cor. Andrews, bds. 30 Hand
 Moynihan Daniel, switchman, Platt st. crossing, house 27 Lake avenue
 Moynihan Dennis F. telegrapher, b. 30 Hand
 Moynihan George W. brakeman, b. 6 Clifton
 Moynihan Jeremiah, laborer, N. Y. C. depot, house 30 Hand [39 Howell
 Moynihan John, engineer, 100 S. St. Paul, h.
 Moynihan Maurice, bookkeeper, h. 6 Clifton
 Muchets Joseph, shoemaker, 81 North Water, house 154 Wilder
MUDGE ADELBERT W. coffin ware-rooms, and undertaker, 121 West Main, house 17 Atkinson.—*See front colored page*

HENRY C. WISNER,

CUT AND PRESSED GLASS TABLE WARE,
No. 33 STATE STREET.

- Mudge Caroline Miss, house 39 Exchange
Mudge Clara A. widow, house 17 Fitzhugh
Mudge Helen C. teacher, Wadsworth School, No. 12, boards 17 Fitzhugh
Mudge William R. claim agent, 59 Powers' bldgs. boards 7 Caledonia avenue
Mudgett John W. grocer, 91 North av. h. do.
Mudgett Wm. 3 Smith's blk. h. 64 Fitzhugh
Muehbeyer John J. shoemaker, h. 362 Brown
Muehl George, porter, Clinton Hotel
Mueller Anna, widow, house 110 Chatham
Mueller Anthony, driver, 4 West av. bds. do.
Mueller August, sausage, 4 West av. h. do.
Mueller Catharine, widow, house 34 Henry
Mueller George, carpenter, house 150 Scio
Mueller Henry, tailor, house Miller n. Bay
Mueller Herman (*Vogel & Mueller*), 40 Front, boards 3 Marietta
Mueller John, laborer, house Miller n. Bay
Mueller John C. brewer, house Vernon park
Mueller John H. tailor, 40 East Main, house 77 West avenue [h. 73 Smith
Mueller Joseph C. laborer, Platt cor. Kent,
Mueller Nicholas, upholsterer, 74 State, h. 60 Nassau
Mueller Sebastian, mason, h. 45 Buchan park
Mueller Wm. laborer, h. Bay near Goodman
Mühl Christian, grocer, 54 Lyell, house do.
Muir Christina, widow, house 83 West av.
Muir John B. salesman, 55 Front, house 110 Tremont [b. 110 Tremont
Muir John P. shoemaker, 91 North Water,
Muir Thomas B. sawyer, 131 N. Water, bds. 110 Tremont
Muisau August, removed to Buffalo
Muisau Charles, deceased April, 1875
Muisau Mena, widow, house 50 Sellinger
Mulcahey Honora, widow, h. Julia n. Troup
Muldoon Patrick, laborer, h. Bolivar n. Smith
Muldoon Wm. teamster, 3 Canal, h. 5 Grape
Mulford Charlotte A. widow, h. 4 East Main near Stillson
Mulgrew Patrick H. house 10 Jackson
Mulholland John, winemaker, 68 East Main, boards 6 Ely [Central av.
Mull Frank, laborer, house Alexander near
Mullen James B. shoemaker, 83 N. Water, boards Reed House
Mullen Jane, widow, boards 23 Monroe av.
Mullen Patrick, carcoupler, N. Y. C. R. R. house 20 Woodbury
Mullen Robert, foreman, house 36 Lime
Mullen Wm. B. clerk, 147 State, h. 125½ do.
Mullen Wm. J. shoemaker, 83 N. Water, b. Reed House [236 N. Clinton
Muller Andrew, shoemaker, 55 Mill, house
Muller Rosa, teacher, Real Schule, 7 Mortimer, boards 9 Rome
Muller William H. laborer, Platt cor. Kent, boards Plymouth av. near Glasgow
Muller, see Mueller and Miller [Lyell
Mulligan Catharine, rag sorter, h. West near
Mulligan Hugh, cooper, 1 St. James park, house 22 Vincent place
Mulligan Hugh P. telegrapher, 34 Arcade, boards Clinton Hotel
Mulligan James, laborer, boards 79 Davis
Mulligan Jas. laborer, b. West n. Erie canal
Mulligan John, laborer, h. West n. Erie canal
Mulligan Mary, seamstress, boards 79 Davis
Mulligan Mary, widow, b. 22 Vincent place
Mulligan Michael, laborer, house 79 Davis
Mulliger John, wagon maker, 125 Lyell, h. Ames near R. R.
Mulliger Joseph, carpenter, b. Ames n. R.R.
Mullins Ann, widow, house 166 Scio
Mullins Cornelius, laborer, house Livingston near North St. Paul
Mullins Michael, shifter, boards 58 Nassau
Mulloy David W. bookkeeper, 8 State, bds. 5 Livingston place
Mulock Christian, cook at Osburn House
Mulqueen James, printer, b. 3 McDonald av.
Mulqueen Mary, tailoress, b. 3 McDonald av.
Mulqueen Maurice, cigar maker, 147 East Main, boards 3 McDonald av. [av.
Mulqueen Michael, laborer, h. 3 McDonald
Mulqueen Michael jr. gasfitter, boards 3 McDonald avenue
Mulroony Edward W. gasfitter, b. Saratoga avenue near House of Refuge
Mulroony John A. engineer, Jay corner Erie canal, b. Saratoga av. n. House of Refuge
Mulroony Sarah, widow, house Saratoga av. near House of Refuge
Mulryan Hannorah, widow, house 32 Bartlett
Mulryan Jeremiah, deceased August, 1875
Mulryan John, laborer, house Plymouth av. near Magnolia
Mulryan John, machinist, 6 Hill, b. Bartlett
Mulryan Martin, rem'd to Philadelphia Pa.
Mulryan Michael J. salesman, Andrews cor. North Water, boards 32 Bartlett
Mulryan Michael J. shoemaker, 81 North Water, boards 102 Whitney
Mulryan Patrick, laborer, house 102 Whitney
Mulvey Frank, slater, boards 2 Green
Mulvey Kate, domestic, boards 23 Vine
Mulvey Michael, polisher, b. 154 N. Clinton
Mumbach George, shoemaker, boards West Maple corner Saxton [b. do.
Mumbach Jacob, clerk, W. Maple c. Saxton,
Mumbach Michael, grocer, West Maple cor. Saxton, house do.
Mumford George E. (*Erickson, Jennings & Mumford*), 25 State, house 37 Troup
Mumford Geo. H. Mrs. deceased May 7, 1876
Mumford Jacob, deceased August, 1875
Mumford Lena, widow, house 88 Pearl
Munce John, engineer, 20 Court, house 128 West Main [b. 28 Chatham
Munden Matthew, salesman, 77 North Water,
Munderback Hiram, teamster, house Cady near Olean [5 Franklin sq.
Munday Edward, shoemaker, 111 State, bds.
Mundy Johnson M. sculptor, 103 Arcade, b. National Hotel
Munger Arthur D. machinist, Court c. Stone, boards 22 Spencer
Munger Frederick W. bds. 106 Mt. Hope av.
Munger Geo. G. lawyer, 72 Powers' bldgs. h. 68 Plymouth avenue
Munger Lyman E. bds. 106 Mt. Hope avenue
Munger Lyman F. bank lock inspector, Court corner Stone, house 22 Spencer
Munger Margaret, widow, house 64 Baden

- Munger Merritt, physician, 76 Monroe avenue, house do.
- Munger Susan T. widow, h. 106 Mt. Hope av.
- Mungovan James, yardman, 33 West avenue, house 37 South Washington [ton
- Mungovan John, laborer, h. 35 S. Washing-
- Munk Benjamin, bookkeeper, 46 Mill, boards 49 Andrews
- Munn Daniel, house Vick park
- Munn Frederick, salesman, boards Vick pk.
- Munn Henry C. (*Keyes & Munn*), 9 Platt, h. 107 West Main [3 Favor
- Munro Henry L. tinsmith, 16 S. St. Paul, bds.
- Munro Jas. gardener, h. St. Joseph n. Norton
- Munroe Betsey E. widow, house 30 Atkinson
- Munsill Sophia, boards 22 Matthews
- Munson Ella I. teacher, Genesee School, No. 4, boards 18 Adams
- Munson Mary J. Mrs. house 18 Adams
- Muntz William, sawyer, house 65 Tyler
- Munz Frank, turner, Aqueduct near canal, boards 58 Sanford [North av.
- Munz George, clerk, 127 Scio, house 159
- Munz John, cabinetmaker, 184 State, house 58 Sanford [58 Sanford
- Munz John L. cabinetmaker, 184 State, bds.
- MURA DOMINICK**, carpenter and builder, 23 Gorham, house do.—*See page 640*
- Mura Justine, widow, house 37 Whitney
- Mura Justine Miss, trimmer, b. 37 Whitney
- Mura Mary E. tailoress, bds. 37 Whitney
- Mura Morand, carpenter, 23 Gorham, house 13 Orange
- Mura Theresa, seamstress, bds. 37 Whitney
- Murat Napoleon, carpenter, h. 14 Gregory
- Murch Henry, saloon, 12 N. Water, house do.
- Murdock Hiram, tin, copper, &c. 122 State, boards Waverley House
- Murdock James, house Frank near Lorimer
- Murdock Sophia P. Miss, house 13 Greig
- Murdock Wm. M. driver, 16 Fitzhugh, house 49 Caledonia avenue
- Murdon Celia Miss, house 24 Cady
- Murdon Edward, deceased, 1876
- Murenberg Morris, tobacconist, 108 St. Joseph, house do.
- Murney Frank J. teamster, house 59 Oak
- Murney James, boards 59 Oak
- Murphy Alfred, helper, 2 N. St. Paul, bds. 8 Bond [hugh, b. 11 Elizabeth
- Murphy Bartholomay W. hackman, 15 Fitz-
- Murphy Bridget, widow, house 15 Munger
- Murphy Bridget, widow, house St. Joseph near Norton
- Murphy Catharine, dressmaker, b. 10 St. Joseph
- Murphy Catharine, widow, house 27 Lind
- Murphy Catharine M. widow, h. 47 Alexander
- Murphy Catharine M. tailoress, b. 47 Alexander
- Murphy Cornelius, engineer, boards 9 Frank
- Murphy Cornelius T. gardener, b. 15 Munger
- Murphy Daniel B. bookkeeper, 53 E. Main, house 87 Frank [h. 26 Walnut
- Murphy Dennis, engineer, N. Y. C. R. R.
- Murphy Edward, switchman, boards 170 Scio
- Murphy Ellen, peddler, b. Vincent pl. n. State
- Murphy Elmur, teamster, 16 Stone, boards 34 Griffith [9 Smith
- Murphy Francis, watchman, 92 State, house
- Murphy Henry G. shoemaker, 111 State, h. 1 Hubbell park [68 Oak
- Murphy Henry W. clerk, 138 W. Main, bds.
- Murphy Hugh, shoemaker, 44 Exchange, b. 42 Ambrose
- Murphy James, deceased July, 1875
- Murphy James, plasterer, boards 2 Centre
- Murphy James, painter, 47 East Main, h. do.
- Murphy James, laborer, bds. 33 S. St. Paul
- Murphy James, machinist, 12 Allen, house Gilmore near Hudson [27 Lind
- Murphy James, laborer, 3 Elizabeth, boards
- Murphy James, laborer, house 27 Monroe av.
- Murphy Jas. W. nurseryman, b. 19 Thompson
- Murphy Jeremiah, laborer, house 17 Hunter
- Murphy Jeremiah, yardman, Osburn House, boards do.
- Murphy John, painter, 3 Canal, b. 60 Spring
- Murphy John, carpenter, boards 27 Lind
- Murphy John, foreman, boards 42 Kent
- Murphy John, laborer, bds. 19 Thompson
- Murphy John J. removed to Fairport
- Murphy Joseph, machinist, Mill corner Platt, house Spring near Caledonia avenue
- Murphy Julia, boards Vincent pl. n. Lake av.
- Murphy Julian L. removed to Florida
- Murphy Margaret, peddler, h. Vincent place near State [Sherman
- Murphy Margaret, widow, house Lyell near
- Murphy Martin, removed from city
- Murphy Mary, laundress, Osburn House
- Murphy Mary, widow, house 92 Childs
- Murphy Mary, domestic, boards 1 George
- Murphy Mary, widow, boards 19 Thompson
- Murphy Mary, widow, house 11 Orchard
- Murphy Mary, widow, house 68 Oak
- Murphy Mary, widow, boards 3 Saxton
- Murphy Mary, widow, house 42 Ambrose
- Murphy Mary, widow, house 51 Munger
- Murphy Mary, widow, house 59 West Maple
- Murphy Mary L. dressmaker, bds. 13 George
- Murphy Michael, brakeman, house 151 N. Clinton [St. Paul
- Murphy Minnie, dressmaker, b. 136 South
- Murphy Nellie, laundress, Osburn House
- Murphy Patrick, laborer, boards 60 Spring
- Murphy Patrick, teamster, house Mt. Hope avenue near nursery
- Murphy Patrick, house 170 Scio
- Murphy Patrick, laborer, h. 33 S. St. Paul
- Murphy Patrick, cooper, West near Lyell, boards 19 Thompson near Lorimer
- Murphy Patrick, laborer, house 112 Pearl
- Murphy Patrick W. tinsmith, 266 State, bds. 27 Lind
- Murphy Peter, laborer, boards 11 Orchard
- Murphy Richard, foreman, h. 3 Anderson av.
- Murphy Sanford W. porter, boards 8 Bond
- Murphy Sarah, widow, house 8 Bond
- Murphy Squires M. carpenter, h. 34 Griffith
- Murphy Sylvester, conductor, house 31 Platt
- Murphy Thomas, conductor, N. Y. C. R. R. house 69 Nassau [Frank
- Murphy Thomas O. clerk, 64 State, boards 22
- Murphy Timothy, laborer, b. Mt. Hope av. near Linden
- Murr Charles, boatman, b. 99 N. Clinton
- Murr Frederick, b. 99 N. Clinton

HENRY C. WISNER,

CRYSTAL BUD VASES, EPERGNES, ETC.,
No. 33 STATE STREET.

- Murr Frederick jr. market, 99 N. Clinton, house do.
- Murr George, butcher, 99 N. Clinton, h. do.
- Murr Michael, tool temperer, 136 Mill, house 81 St. Joseph
- Murr see Muir
- Murray Adelaide H. boards 16 Howell
- Murray Ann, widow, boards 326 State
- Murray Annie, dressmaker, 326 State, h. do.
- Murray Bartholomew, engineer, h. 192 North
- Murray Bernard, deceased Oct. 1875
- Murray Catharine, boards 37 Platt
- Murray Chas. cooper, Brown's al. bds. 29 do.
- Murray Charles H. shoemaker, bds. Bowen near Bates
- Murray Delia Mrs. house 96 State
- Murray Elizabeth, boards 147 University avenue
- Murray Elizabeth, widow, house 145 University avenue
- Murray Ellen, weaver, bds. 11 Brown's alley
- Murray Francis, clerk, 182 State, bds. Reed House
- Murray Francis C. clerk, 64 State, bds. 113½ East Main
- Murray Frank L. compositor, 3 West Main, house Maple place near Monroe avenue
- Murray Henry S. conductor, N. Y. C. R. R. boards Congress Hall
- Murray Herman R. salesman, Exchange cor. Court, boards 9 Stillson
- Murray Hugh, cooper, Brown's al. b. 29 do.
- Murray Hugh F. cooper, Brown's al. h. 29 do.
- Murray James, blacksmith, h. Fourth corner Perkins
- Murray James, tailor, house Bowen n. Bates
- Murray James C. farmer, b. Orchard n. R. R.
- Murray James M. solecutter, 83 N. Water, h. 4 Chestnut park [Catharine
- Murray James S. cutter, 70 Mill, house 33
- Murray Jane Miss, removed to Chicago, Ill.
- Murray John, cooper, Brown's alley, house 182 Champlain
- Murray John, laborer, house 2 Smith
- Murray John, driver, boards 167 State
- Murray John, blacksmith, Lake avenue cor. White, boards 15 White
- Murray John H. painter, bds. 8 Edinburgh
- Murray Julia A. widow, house 15 Charlotte
- Murray Margaret, b. East av. c. Alexander
- Murray Michael, driver, 45 Fitzhugh, house 8 Edinburgh
- Murray Peter, laborer, house 15 White
- Murray Peter, switchman, North York st. crossing, house 115 West Maple
- Murray Peter W. painter, 100 Mill
- Murray Robert, quarryman, h. Orchard cor. railroad [Costar
- Murray Robert J. laborer, boards West near
- Murray Sarah, paster, boards 29 Brown's al.
- Murrad Thomas, shoemaker, 83 N. Water
- Murray Thomas, laborer, boards Clifton near Summer
- Murray Thomas, bds. 145 University avenue
- Murray Thomas, boarding house, 113½ East Main, house do.
- Murray Thos. F. machinist, boards 15 White
- Murray William, laborer, bds. 8 Edinburgh
- Murray William A. driver, h. 88 Atkinson
- Murray Wm. C. telegrapher, 34 Arcade, b. 16 North Clinton [8 Seward
- Murrell John, hostler, National Hotel, house
- Murscha Louis, laborer, house 206 Jay
- Muskau Charles, teamster, h. Seager n. Lewis
- Muskau Rudolph, carpenter, boards Seager near Lewis
- Muss Chas. laborer, house 19 Hoeltzer
- Muss Frederick, laborer, house 33 Sellinger
- Mussmaecher George, shoemaker, house Ulm near Bay
- Muth John O. house 24 Morris
- Muth Ottilia, widow, boards 40 Delevan
- Mutschler Henry, clerk, 81 East Main, bds. 25 Clinton place [house 13 Cole
- Mutschler Henry, driver, 117 North Clinton,
- Mutschler Herman, crockery, 81 E. Main, house 25 Clinton place [Ill.
- Mutschler John G. removed to Chicago,
- Mutz Gustav, polisher, 179 N. St. Paul, h. 146 St. Joseph [nings
- Myburn John, laborer, h. Swinerton n. Jen-Myer Frederick C. carpenter, h. 43 Sanford
- Myerly Delia M. widow, boards 18 Canal
- Myers Andrew, moulder, boards 66 Pearl
- Myers A. Frederick, architect, 38 Smith's block, house 12 Munger
- Myers Charles, butcher, h. Goodman n. Bay
- Myers Elizabeth, widow, h. 214 Alexander
- Myers Emanuel, whitewasher, h. 41 S. Washington
- Myers Frank H. glass blower, b. 38 Bartlett
- Myers Frederick, carpenter, h. Ames n. West Maple
- Myers Henry, house 4 Alexander [h. do.
- Myers Isaac, sewing machines, 54 N. Clinton,
- Myers Jacob, carpenter, h. West Maple near Ames
- Myers Jacob, clothing, 8 Front, house 42 University avenue
- Myers James F. teamster, boards 66 Pearl
- Myers Jenny Mrs. boards 24 Meigs
- Myers John, carpenter, house 12 Munger
- Myers John, peddler, 11 Monroe av. h. 11½ do.
- Myers John D. carpenter, boards 12 Munger
- Myers John H. gilder, house 5 Griffith
- Myers J. Hiram, supt. sales, Roch. Agricultural Works, 100 S. St. Paul, house 128 Fitzhugh
- Myers Laura, widow, boards 17 Evergreen
- Myers Morris, clerk, 8 Front, bds. 42 University avenue [bds. 169 E. Main
- Myers Peter (*Hagen & Myers*), 4 N. Clinton,
- Myers Robert M. (*Hawley, Myers & Co.*), 55 State, boards 50 Marshall
- Myers Sarah, widow, house 1 Green
- Myers Wesley, agent, house 21 South avenue
- Mykins Daniel J. planemaker, Mill near Platt [University av.
- Mylacraïne John E. fresco painter, house 61
- Mylacraïne Philip, boards 39½ Monroe avenue
- Mylacraïne Robert, painter, 14 Stone
- Mylacraïne Sarah J. dressmaker, boards 57 University avenue
- Mylacraïne William, paperhanger, 9 West Main, house Frances n. Adams
- Myles Lindsay (*Myles & Fordyce*), 146½ West Main, house do.

- Myles & Fordyce (*L. Myles and H. Fordyce*),
boarding house, 146½ W. Main
- Mylrea Elizabeth Mrs. dressmaker, 183 State,
house do.
- Mylrea James, tailor, 57 State, house 183 do.
- NAAB GEORGE, clerk, boards 84 Tremont
- Naab John, laborer, house 84 Tremont
- Naber Anthony, coal, 72 Chatham, house do.
- Naber George J. bookkeeper, 7 Atwater, b.
72 Chatham [n. Atkinson
- Nacey John F. laborer, house Peach alley
- Nadaje John, cigarmaker, 48 Exchange, bds.
Reed House [bds. 20 Brown's alley
- Nadig Jerome, cigarmaker, Mill c. Factory,
- Nadig John, cigarmaker, b. 20 Brown's alley
- Nadig Martin H. machinist, h. 20 Brown's al.
- Nadig Mary A. widow, house 6 Lowell
- Naegele Athanas, mason, house Laforce park
- Naegele Dominick, cabinet maker, house
Clifford near Thomas
- Naegele Elizabeth, widow, boards 7 Kelly
- Nagel Frederick, laborer, house Klinck near
Monroe avenue [h. 31 Wilder
- Nagel George A. cooper, Atwater c. Water,
- Nagel Nicholas, laborer, house Vernon park
near North Clinton
- Nagelin Leonard, shoemaker, 227 E. Main,
house 130 Scio
- Nagle Albert, laborer, house 4 Widman
- Nagle Andrew (*Hotchkiss & Nagle*), 174 State,
house 287 do. [h. 113 St. Joseph
- Nagle Edward L. scalemaker, 5 Andrews,
- Nagle Ferdinand, boards 16 Widman
- Nagle Fred. clerk, 113 St. Joseph, bds. do.
- Nagle George, scalemaker, 5 Andrews, bds.
113 St. Joseph
- Nagle Jacob, deceased 1875
- Nagle Jacob, clerk, 134 State, bds. 52 State
- Nagle John (*Forsyth & Co.*), 5 Andrews, h.
113 St. Joseph
- Nagle John, market, 52 South av. house do.
- Nagle John A. (*Corbusier & Nagle*), 54 South
avenue, boards do. [184 N. Clinton
- Nalbach George, tanner, 51 North Water, h.
- Naracon Villona, boarding house, 5 North
Washington [b. 8 Scio
- Naramore Charles, clerk, 73 East Main,
- Naramore John, dentist, house 8 Scio
- Narkursky Max, peddler, house 8 Hamburg
- Nash Andrew L. E. shoemaker, h. 158 Frank
- Nash Chauncey, lawyer, 36 Arcade, house 50
Hamilton place [b. 158 Frank
- Nash Clarence H. machinist, 18 East Main,
- Nash Isabella W. widow, h. 19 N. St. Paul
- Nash Louis K. student, 36 Arcade, boards
50 Hamilton place [York House
- Nash William, blacksmith, 129 Mill, boards
- Nash Wm. farmer, house Carter near Norton
- Nash Wm. C. clerk, Osburn House, bds. do.
- Nass Frances, widow, house 82 St. Joseph
- Nass Frank, carriage maker, 3 Elizabeth, h.
3 Putnam [3 Putnam
- Nass Joseph, wheel maker, 3 Elizabeth, bds.
- Nass Joseph J. carver, 184 State, boards 82
St. Joseph [97 N. Clinton
- Nathan Joseph, fringe maker, 98 E. Main, h.
- Naughton Eliza, widow, house 238 N. Clinton
- Nay Allen W. engineer, house 100 Frank
- Nay George W. engine dispatcher, house 23
Madison
- Naylon Martin, engineer, 12 White, house
65 Magne
- Naylon Michael F. painter, Brown c. Jones,
house 5 Magne
- Naylon Thomas, machinist, house 67 Magne
- Naylor Amos, bookkeeper, 55 Mill, h. Fran-
ces near Strong [55 Saxton
- Naylor James jr. machinist, 124 Mill, house
- Naylor James, sexton, house 43 Walnut
- Naylor John W. bookkeeper, 92 State, house
Rowe near Second
- Nazareth Convent, Jay corner Frank
- Neale Frederick, plasterer, b. 4 Briggs' block
- Neale, see McNeal, Neil, O'Neil and Kneale
- Neary John E. cooper, boards 11 Lime
- Neary Robert, health inspector, h. 11 Lime
- Needham Eunice, dressmaker, 102½ Allen,
house do. [canal, h. 102½ Allen
- Needham John Q. cabinetmaker, Jay c. Erie
- Neef Philo, brakeman, house 5 Davis
- Neel John, bookkeeper, 10 State, bds. 146½
West Main
- Neely Albert D. Mrs. boards Ayer's Hotel
- Neely James W. carpenter, h. 49 Tremont
- Neely Margaret E. boards 3 East
- Neener Baltzer, laborer, h. Sibley n. Culver
- Neener Margaret, widow, b. Sibley n. Culver
- Neer William E. painter, 16 Stone and
(*Phillips & Neer*), house 17 do.
- Neerpasch John, carver, 184 State, h. 55 Jay
- Neeson Hugh, shoecutter, 111 State
- Neff Godfrey S. filter manuf. 18 West Main,
house 15 Evergreen
- Neff Samuel, expressman, 35 Exchange, h.
14 Edinburgh
- Neff Wendelin, stonemason, 54 Fitzhugh
- Negele Dominick, cabinetmaker, 6 Front
- Negus Byron S. marble cutter, house 111
Mt. Hope avenue
- Negus Nelson P. machinist, h. 73 Asylum
- Negus William C. teamster, h. Mt. Hope av.
near Comfort
- Neher Frank, laborer, 138 Mill, h. 100 Ames
- Neiderhaiser John, brewer, Atwater corner
Water, boards 111 North avenue
- Neidert Joseph, cabinetmaker, 184 State, h.
212 Monroe avenue [bds. do.
- Neidert Joseph, coachman, 51 S. Clinton,
- Neidert Leopold, cabinetmaker, Hydraulic
bldgs. house 15 Holland
- Neidinger Eve C. widow, boards 15 Henry
- Neidinger Geo. H. blacksmith, h. 15 Henry
- Neidinger Henry, machinist, N. Water cor.
Andrews, house 37 German
- Neidinger John, carpenter, house 37 German
- Neier Michael, mason, bds. Goodman n. Bay
- Neil Eliza Miss, house 159 Fitzhugh
- Neill Joseph J. carpenter, house 59 Spring
- Neiner George, removed from city
- Neiner John, laborer, house 17 Huntington
- Nekels Sophie M. widow, b. 35 Hoeltzer
- Nelder Henry, butcher, 293 State, house 4
Thompson
- Nell Catharine, widow, house 96 Scio
- Nell John J. (*Nells & Kern*), boards 96 Scio

Nell Peter A. (*Nells & Kern*), h. 172 State
 Nelligan Hannah J. Mrs. saloon, 284 State,
 house do. [9 Galusha
 Nelligan James, cigarmaker, 45 E. Main, b.
 Nelligan James, laborer, 10 S. Water, house
 16 Lowell [9 Galusha
 Nelligan John, foreman, 192 State, house
 Nelligan Lawrence, tobacconist, 192 State,
 house 7 Galusha [bds. 16 Lowell
 Nelligan Michael W. moulder, 10 S. Water,
 Nelligan Simon T. cigarmaker, 139 St. Jos-
 eph, house do. [9 Galusha
 Nelligan Wm. tobacconist, 192 State, boards
 Nellis Alice, domestic, boards 54 Park av.
 Nellis Emma E. boards 24 Pearl
 Nellis James, printer, 23 W. Main, boards
 118 Plymouth avenue
 Nellis James H. lime manuf. rear Plymouth
 avenue near Rapids, house 3 East
 Nellis Mary C. widow, house 44 Pearl
 Nellis Michael, shoemaker, 15 Mill, h. Cale-
 donia avenue near Glasgow
NELLS & KERN (*P. A. and J. J. Nell, and
 F. Kern*), marble workers and dealers,
 166 State.—*See page 646*
 Nelson Alice, domestic, 83 Lake avenue
 Nelson Augustine E. bookkeeper, 17 E.
 Main, boards 24 North St. Paul
 Nelson Catharine, widow, house 1 Pine
 Nelson Catharine A. dressmaker, boards 42
 Hamilton place
 Nelson Charles, removed to Buffalo
 Nelson Daniel B. brakeman, b. Alexander n.
 Central avenue [North Ford
 Nelson Edward, hostler, 159 State, boards 4
 Nelson Frederick, cabinetmaker, 184 State,
 house 103 Pinnacle avenue
 Nelson George, bookkeeper, 61 West Main,
 b. 103 Pinnacle av. [Chestnut pk.
 Nelson James, gas fitter, 153 E. Main, bds. 4
 Nelson John F. removed to New York city
 Nelson Margaret Mrs. house 42½ Lyell
 Nelson Mary, boards 42 Hamilton place
 Nelson Peter, shoemaker, 111 State, boards
 York House [railroad
 Nelson William, gardener, h. N. Union n.
 Neracker Frank J. boxmaker, h. 4 Edward
 Neracker Jacob, nurseryman, house Culver
 near Schanck av. [near Schanck av.
 Neracker Jacob, jr. nurseryman, b. Culver
 Nermbergher Louis, cabinetmaker, bds. 69
 Lowell [Walnut
 Nernst Augustus, laborer, house Campbell n.
 Nersinger Frances, widow, house 6 Gorham
 Nersinger Lawrence, market, 182 N. St.
 Paul, house 3 Lowell [4 Edward
 Neruch Francis, boxmaker, ft. Centre, house
 Nesbit Alexander F. shampooer, 59 State, b.
 79 Jay
 Nesbit Thomas, clerk, house 29 Ontario
 Ness Lewis, teamster, house 44 Charlotte
 Nessel Peter, 196 North St. Paul
 Neth George, butcher, 128 Scio, boards do.
 Neth John, stonecutter, b. 150 S. St. Paul
 Neubauer Gottlieb, brewer, Colvin c. Syke,
 boards 149 W. Maple
 Neubauer Henry, carpenter, h. 59 Saratoga
 avenue

Neubauer George, baker, 45 Fitzhugh, h. 110
 Campbell [29 Wilder
 Neubeck Adolph, coachmaker, 3 Canal, h.
 Neubert Eliza, milliner, 129 E. Main, h. 1
 Delevan.
 Neubert John J. trimmer, house 1 Delevan
 Neuburger Henry, shoemaker, h. W. Maple
 near Ames
 Neuburger Louis, tinsmith, 90 East Main
 Neuer Catharine, widow, house 9 Sellinger
 Neuer Edward, clerk, 72 East Main, boards
 9 Sellinger [9 Sellinger
 Neuer Frederick, cabinetmaker, boards
 Neuer Henry, spectacle maker, boards 9
 Sellinger [Oakman
 Neuer Jacob, tailor, 114 State, house 19
 Neuffer Gottlob, shoemaker, h. 202 North
 Clinton [Stone
 Neugen Charles, laborer, 20 Court, house 45
 Neuhart Emil (*Mathis & Neuhart*), b. 229 E.
 Main
 Neuhart Michael, grocer, 229 E. Main, h. do.
 Neumann Augusta, widow, bds. 42 Howell
 Neumann John, mason, h. 104 N. St. Paul
 Neun Fred. shoemaker, River n. N. St. Paul,
 boards 19 Hanover
 Neun George, baker, 262 State, boards do.
 Neun John, foreman, Rochester Chemical
 Works, 113 W. Main, h. 29 Catharine
 Neun Sebastian, laborer, house 10 Hoeltzer
 Neuner Alfred A. clerk, 62 State, house 4
 Clarissa [66 do.
 Neusch John, janitor, Walbridge's block, h.
 Neuwirth Christian, tailor, 231 Brown, h. do.
 Neville Flora E. widow, b. 17 Gardiner pk.
 Neville Mary, domestic, boards 10 Prince
 Neville Mary, widow, bds. 57 Pinnacle av.
 Neville Philip, bridge builder, bds. 36 Platt
 Neville Thomas, laborer, Brown cor. Jones,
 house 51 Saxton [Hall, h. 62 Jones
 Neville Thos. J. sec'y. Executive Board, City
 New Charles H. removed to Penn Yan
 Newberry Charles K. compositor, 3 West
 Main, house 35 Clifton
 Newberry Sarah A. widow, house 35 Clifton
 Newborn Jennie, milliner, b. 38 Stillson
 Newborn Stephen R. flour, S. St. Paul cor.
 Court, house 38 Glasgow
 Newbury Carrie E. Miss, boards 81 Tappan
 Newbury Moses H. removed to Indianapolis,
 Indiana [boards 16 Lake av.
 Newby Robert W. fireman, N. Y. C. R. R.
 Newby William, miller, People's Mills, h.
 16 Lake avenue [109 Jones
 Newcomb Aaron N. machinist, 138 Mill, h.
 Newcomb Emma Miss, clerk, Clifton cor.
 Frances [near Goodman
 Newcomb Jerome B. farmer, house Jennings
 Newcomb Patrick, laborer, h. 1 Champion
 Newcomb Patrick jr. boards 1 Champion
 Newcomb Robert H. stonecutter, house 2
 George's park
 Newcomb Theodore, boards 6 Summer
 Newdale Albert, florist, h. Colvin n. West av.
 Newdale Emil (*M. Newdale & Son*), boards
 Colvin near West avenue
 Newdale Malvina & Son (*Emil Newdale*),
 florists, Colvin n. West avenue, house do.

Newell Albert C. real estate, h. 120 Alexander
 Newell Andrew C. frame maker, 38 Gorham,
 boards 27 Conkey avenue
 Newell George H., Empire Moulding Works,
 37 Gorham, house 38 do.
 Newell Jared M. physician, b. 120 Alexander
 Newell Mary A. boards 120 Alexander
 Newell Nellie, house 13 Stepheny's park
 Newell Susan Miss, boards 120 Alexander
 Newell Thaddeus S. lawyer, h. 15 Clinton pl.
 Newhafer Bertha, clerk, boards 47 Chatham
 Newhafer Caroline, widow, h. 47 Chatham
 Newhafer Louis, shoecutter, b. 47 Chatham
 Newhafer Nathan N. clerk, 73 E. Main, bds.
 47 Chatham
 Newhafer Sarah, clerk, boards 47 Chatham
 Newhall Harriet C. widow, house 124 Scio
 Newkirk Hawley A. assistant bookkeeper,
 33 State, boards 34 North Washington
 Newlove Maggie Mrs. boards 206 State
 Newman Albert, carriage trimmer, boards 62
 Delevan [near North
 Newman Charles, laborer, house Channing
 Newman Charles, marble cutter, b. 62 Delevan
 Newman Charles, musician, house 66 Scio
 Newman Charles H. (*Maxwell, Newman,*
McMannis & Co.), 22 S. St. Paul, house
 75 Martin
 Newman E. Lansing, pastor North avenue
 M. E. church, house 4 Concord avenue
 Newman John, lamplighter, house 5½ Davis
 Newman John, laborer, house 6 Wait
 Newman John, laborer, Clarissa c. Exchange,
 house 12 Champlain
 Newman John, musician, house 62 Delevan
 Newman John A. clerk, boards 62 Delevan
 Newman John J. moulder, Brown's race n.
 Furnace, house 71 Sherman
NEWMAN JOSIAH, liquors, wines, &c.
 and rectifier, 112 Front, house 26 Kent.
 —See page 561
 Newman Lewis, removed to Medina
 Newman Robert, machinist, house 99 Jay
 Newman Robt. G. clerk, 79 State, b. 99 Jay
 Newman Sidney A. druggist, 115 East Main,
 house 17 Chestnut [h. 48 Magne
 Newman William, cooper, 1 St. James park,
 Newman William C. wagonmaker, 3 Eliza-
 beth, house 13 Murray [Union
 Newton Albert R. clerk, 144 E. Main, h. 15 N.
 Newton Arthur M. removed from city
 Newton Charles L. clerk, 144 E. Main, boards
 50 East avenue
 Newton John, removed from city
 Newton Julia, widow, boards 10 Elizabeth
 Newton Lyman M. deputy sheriff, Court
 House, h. 10 Elizabeth [h. 50 East av.
 Newton Truman A. grocer, 144 East Main,
 Niblack Albert, plumber, bds. 156 W. Main
 Niblack Alonzo L. porter, h. 4 Plymouth av.
 Niblack George T. agent, h. 156 West Main
 Niblack S. H. Mrs. hoop skirts, 156 West
 Main, house do. [73 E. Main
 Niblock John J. salesman, 21 W. Main, house
 Nichlis Julius, brewer, boards 6 Cliff
 Nichol James, agent, house 235 East Main
 Nichol William B. fireman, N. Y. C. R. R.
 house 46 Thompson

Nicholas Eliza A. Mrs. boarding house, 203
 State, house do.
 Nicholas John G. saloon, 161 W. Main, h. do.
 Nicholas Rolla D. painter, Brown cor. Jones,
 boards 203 State
 Nicholas Wm. J. F. carpenter, house East
 avenue opposite Bowen [Ill.
 Nichols Alphonzo N. removed to Rockford,
 Nicholls Abram M. reporter, b. 52 S. Union
 Nichols George W. machinist, Brown corner
 Jones, house 60 Concord avenue
 Nichols Geo. W. removed to Battle Creek,
 Michigan
 Nichols Harvey N. agent for Cincinnati safes,
 6 Corinthian Hall bldg. house 111 Meigs
 Nichols Helen, seamstress, boards 138 Frank
 Nichols Isabel, widow, house 54 William
 Nichols James E. student, University of Ro-
 chester, boards 78 Fitzhugh
 Nichols Lorrain L. surveyor, 35 Smith's blk.
 house at Pittsford
 Nichols Marion L. real estate, 14 Smith's
 block, house Genesee near Magnolia
 Nichols Sam'l W. student, Roch. Theological
 Seminary, boards Trevor Hall
 Nichols Sarah J. Mrs. princ. Roch. Female
 Academy, 70 Fitzhugh, house 68 do.
 Nicholson Catharine, widow, bds. 126 Mt.
 Hope avenue [51 Bolivar
 Nicholson Charles E. gilder, 8 Allen, boards
 Nicholson Charles F. dyer, Kelly c. Joiner,
 boards do.
 Nicholson Chas. J. carpenter, bds. 10 Grand
 Nicholson George, dyer, Kelly corner Joiner,
 house 85 Joiner
 Nicholson Geo. painter, 51 Bolivar, house do.
 Nicholson Geo. A. painter, 12 Stone, boards
 51 Bolivar [boards do.
 Nicholson Geo. jr. dyer, Kelly corner Joiner,
 Nicholson Jane A. Mrs. house Mt. Vernon
 avenue, corner Lewis
 Nicholson Robert, boatman, boards 10 Grand
 Nicholson William, house 10 Grand
 Nicholson Albert G. agent, American Express
 Co. 83 State, house 85 do.
 Nicholson Edward W. clerk, 83 State, boards
 Clinton Hotel
 Nickerson Charles M. pastor, church of
 Epiphany, house Frances opp. Adams
 Nickerson James H. carpenter, house 68
 Monroe avenue [Lock Lake
 Nickerson Livingston B. removed to Hem-
 Nickerson Susan C. widow, boards Frances
 opposite Adams
 Nickl Hannah, widow, boards 55 Rauber
 Nickles John, teamster, h. 74 Tappan n. Scio
 Nicklis Julius, brewer, 139 N. St. Paul, bds.
 171 do. [boards 60 Lorimer
 Nicol Geo. S. shoemaker, House of Refuge,
 Nicol Jonathan, shoemaker, 340 State, house
 60 Lorimer
 Nicol Matthew, shoemaker, h. 60 Lorimer
 Nicolai Fred, laborer, house 25 Rhine
 Nicolai William C. gilder, 126 State, boards
 190 North Clinton [phia, Pa.
 Nicoud Simon A. R. removed to Philadel-
 Niebling Frank, turner, 7 N. Water, boards
 8 Baden

- Niebling John, blacksmith, 100 South St.
Paul, house 8 Baden
- Niebling John V. stovemounter, 187 West
Main, boards 8 Baden [29 Kelly
- Nied Eugene, machinist, Mill c. Factory, h.
Niedermeier John (*Albrecht & Niedermeier*),
Clifford n. Edward, h. Sellinger n. St.
Joseph [Paul, h. 3 Hudson
- Niedermeier Tiberius P. finisher, 22 S. St.
Niederpruem J. William, bookkeeper, bds.
Cataract
- Nieman Hannah, widow, house 46 Baden
- Niendorf William, laborer, house 7 Foehner
- Nientimp Ignatz, musician, 70 St. Joseph,
house do. [Hudson
- Nientimp Louis, painter, house Bernard n.
Nier Charles, teamster, 6 Frost av. house 81
Frances [Jay
- Nier Edward J. engraver, 24 E. Main, b. 9½
Nier Ellen, dressmaker, 9½ Jay, house do.
- Nier George F. shoemaker, 124 Front, boards
9½ Jay [near Perkins
- Nier John G. bedstead maker, h. White alley
Nier Peter, cigar maker, boards 4 Champion
- Nier Philip, chairmaker, lower falls, house
4 Champion
- Niers Mary Mrs. house 78 Sibley's block
- Nieser John, laborer, h. Field n. Monroe av.
- Niewerde Frederick, cigar maker, house 11
Dover [house 71 St. Joseph
- Niewerde Herman J. cutter, 83 N. Water,
Niggli Emil, machinist, house 21 Lewis
- Nigham James, deceased July, 1875
- Nigham Margaret, widow, h. 5 Brown's alley
- Nigham Michael, laborer, house 59 Saxton
- Nihoff John, laborer, boards 59 Spring
- Niles Adelia, widow, boards 197 North
- Niles Edwin D. fireman, h. 21 Alexander n.
Central avenue
- Niles Francis, marble polisher, 122 South St.
Paul, h. 75 Mt. Hope avenue
- Nippert Mary M. saloon, 20 S. St. Paul, h. do.
- Nirdlinger Albert H. salesman, Exchange c.
Court, boards Whitcomb House
- Nisbet Alexander, machinist, house 79 Jay
- Nisbet Ebenezer, removed to Montreal
- Nisbet William E. clerk, 54 Platt, b. 79 Jay
- Nissen John F. foreman, 87 Exchange, h.
339 Brown
- Niven Alexander R. painter, b. 8 Fitzhugh
- Niven Benjamin D. clerk, 134 W. Main, bds.
8 Fitzhugh [city line
- Niven David, farmer, h. Thurston road near
Niven David, janitor, Court House, h. 142
West avenue
- Niven David jr. boards 142 West avenue
- Niven David M. clerk, 134 West Main, bds.
8 Fitzhugh [avenue
- Niven Elizabeth Miss, copyist, b. 142 West
- Niven James M. iron worker, h. 43 Reynolds
- Niven John A. baggageman, R. & S. L. R.
R. W. Maple c. Saxton, b. 142 West av.
- Niven John S. farmer, h. Thurston road near
city line [8 Fitzhugh
- Niven J. Renwick, clerk, 134 W. Main, bds.
- Niven Robert, produce, house 11 Cypress
- Niven William H. grocer, 134 West Main,
house 8 Fitzhugh
- Niven William H. jr. clerk, 134 W. Main,
b. 8 Fitzhugh
- Nixon Ella, widow, boards 6 Gorham
- Nixon John, laborer, house 163 South avenue
- Nixon Sarah, widow, house 25 S. St. Paul
- Noack William, removed to Germany
- Noah William G. salesman, 82 State, h. 30
Broadway
- Noble Lucy A. widow, house 44 South av.
- Noble Mary E. Miss, boards 20 Clarissa
- Noce Antonio, peddler, house 2 Clark
- Nodecker Christian, laborer, 141 N. Water,
house 41 Baden
- Nodecker George, laborer, b. Magne n. R. R.
- Nodecker Gottlieb, laborer, house Orchard
near railroad [railroad
- Nodecker John, laborer, boards Orchard n.
- Nodecker John, shoemaker, h. Alexander
near Bay
- Nodyne Rosa H. dressmaker, b. 4 Phelps av.
- Noechel Franz Joseph, carpenter, Exchange
corner Court, house 10 Sheridan park
- Noeth George H. upholsterer, 7 North Wa-
ter, boards 132 North Clinton
- Noeth Michael, mason, house 157 N. Clinton
- Nolan Andrew, laborer, h. Magne c. Saxton
- Nolan Andrew, laborer, Brown's race near
Furnace, house 204 Oak near Lyell
- Nolan Catharine, widow, house 23½ Gregory
- Nolan Catharine, widow, house 160 State
- Nolan Charles, moulder, 145 N. Water. bds.
160 State [Troup, h. 91 Adams
- Nolan Charles, teamster, Exchange opposite
- Nolan Elizabeth, domestic, boards 46 Spring
- Nolan James, laborer, house 195 Oak
- Nolan James 2d, laborer, boards 31 Hill
- Nolan John, gardener, h. Leighton avenue
- Nolan John, laborer, house Orchard n. Lime
- Nolan John, laborer, boards 37 Platt
- Nolan Joseph, laborer, house 114 Atkinsen
- Nolan Maggie, domestic, 22 Frank
- Nolan Patrick, fireman, h. Sherman c. Otis
- Nolan Patrick, yardman, 102 Mill, bds. do.
- Nolan Peter, teamster, house 24 Cliff
- Nolan P. E. accountant, 147 State, h. 9 East
- Nolan Terence, teamster, house 7 Brisbane
- Nolan Thomas, student, University of Roch-
ester, boards 9 East
- Nolan Thomas, laborer, h. 51 Mt. Hope av.
- Nold Louis, shoemaker, 27 Walbridge's blk.
house 5 Catharine [house 11 Wait
- Nold Sebastian, cooper, Smith n. Erie canal,
- Noll Margaret, widow, house 27 Nassau
- Noll Mary, tailoress, boards 27 Nassau
- NOLTE ADOLPH**, publisher Rochester
Observer, 23 West Main, house 142 N.
St. Paul.—See page 521
- Noonan Ellen, widow, house 8 Smith
- Noonan Kate, box maker, boards 8 Smith
- Noonan Patrick T. clerk, 113 State, boards
8 Smith [boards 68 S. St. Paul
- Norcross Asa B. blacksmith, Court c. Stone,
- Norden Henry, special agent Rochester Ger-
man Insurance Co. W. Main c. Fitzhugh,
house 32 Hanover
- Norman Charles, clerk, 18 Arcade, boards
4 Gardiner park
- Norman Thomas, brakeman, h. 246 North

Normile Henry, grocer, 19 Smith, boards do.
 Normile James, saloon, 170 State, b. 19 Smith
 Normile Patrick, salesman, 79 E. Main, bds.
 19 Smith [8 West av. h. 28 King
 Normington Mark (*Holloway & Normington*),
 Norris Ella, teacher, Glenwood School, No.
 7, boards Marietta near N. St. Paul
 Norris Fred. photographer, bds. 61 Asylum
 Norris George, teamster, house 61 Asylum
 Norris George E. nursery stock dealer, house
 East av. Brighton village
 Norris James C. carriage painter, 3 Canal,
 boards 66 Troup [66 Troup
 Norris James Q. coach painter, 3 Canal, h.
 Norris John F. painter, boards 23 Marietta
 Norris John V. driver, house 23 Stone
NORRIS J. B. & SON (*J. F. Norris*), nur-
 serymen, East av. Brighton village.—*See*
page 559 [ton
 Norris J. F. (*J. B. Norris & Son*), b. at Bigh-
 North Henry, cabinetmaker, foot Centre, h.
 5 Maria
 North Salome Miss, bds. 26 Saratoga avenue
 North Walter S. shoemaker, 124 Front, h.
 • 137 North avenue [R. R. h. at Batavia
 Northam Festus N. yardmaster, Goodman c.
 Northrop Andrew G. deceased Oct. 9, 1875
 Northrop Ann C. widow, bds. 28 North av.
 Northrop Benjamin, farmer, house Culver n.
 Monroe avenue
 Northrop Burr, boards 132 Monroe avenue
 Northrop Burr S. house 28 North avenue
 Northrop Fanny A. widow, b. 28 S. Clinton
 Northrop Isaiah B. salesman, 14 Mumford,
 boards 28 North avenue
 Northrop Mary A. widow, house 27 Howell
 Northrop Nehemiah B. house 32 N. St. Paul
 Northrup Edmund, removed to Ithaca
 Northrup Esther S. Miss, house 35 Howell
 Northway William R. civil engineer, W. W.
 City Hall, h. 174 State [230 N. Clinton
 Norton Bartholomew, whitener, 38 Gorham, b.
 Norton David, painter, house 7 Hamburg
 Norton Elizabeth H. widow, boards 26 Hill
 Norton Frank M. carriage trimmer, boards
 10 Emmett [bldgs. house do.
 Norton Henry B. draughtsman, 175 Powers'
 Norton Henry O. clerk, bds. 94 Alexander
 Norton John, bootmaker, 91 N. Water, house
 22 Manhattan
 Norton John D. oil, house 94 Alexander
 Norton Joseph F. compositor, 16 W. Main,
 boards 66 Kent
 Norton Mary Mrs. house 2 Mumford
 Norton Michael, switchman, N. Clinton st.
 R. R. crossing, house 21 Joiner
 Norton Patrick, car inspector, N. Y. C.
 depot, house 10 Emmett
 Norton William B. rem'd to Mt. Vernon, O.
 Nostrant Frank, brakeman, N. Y. C. R. R.
 house 10 Drayton [277 St. Joseph, h.
 Nothaft Jacob, woodworker, 3 Elizabeth, h.
 Nothaft Louis, carpenter, house 8 Vienna
 Nothaker Christian, laborer, house 41 Baden
 Nothaker Christian jr. carpenter, b. 41 Baden
 Nothaker John, baker, 107 St. Joseph, h. do.
 Nothaker John C. shoemaker, River near
 N. Water, house Hebard near Bay

Nothaker Matthew, boards 107 St. Joseph
 Nothnagle Fred. A. carpenter, h. 23 Grand
 Nourse Susan, widow, house 39 Asylum
 Nourse William G. discount clerk, 1 Powers'
 bldgs. boards 39 Asylum
NOVELTY SUPPLY CO. house furnish-
 ing goods, 16 Madison.—*See page 619*
 Nowack Albert, teamster, house 13 Hoeltzer
 Nowack Charles J. laborer, house 71 Kelly
 Nowack Ferdinand, laborer, h. 20 Vienna
 Nowack Fredericka, widow, bds. 20 Vienna
 Nowack Gustave, laborer, house 20 Vienna
 Nowack Louis, laborer, boards 20 Vienna
 Nowacki Joseph, tailor, house 72 Saxton
 Noyce James, carpenter, Minerva alley,
 house 251 North
 Noyes Harriet E. widow, house 22 Park av.
 Noyes John, carpenter, house 62 Broadway
 Noyes Milton, lawyer, 18 Smith's block, h.
 22 Park avenue
 Nuesslein Joseph, clerk, 31 Front, boards do.
 Nugent Charles, foundryman, house 45 Stone
 Nugent Ella, thermometer maker, boards
 309 State [N. St. Paul
 Nugent John, clerk, 26 N. Water, boards 102
 Nugent Mary, widow, house 27 Lancaster
 Nugent Robert, waiter, house 48 Frank
 Nunn Frank J. machinist, house 317 Brown
 Nunn Gregory, vinegar maker, 68 Orange,
 house do.
 Nunn Joseph A. laborer, house Jay opposite
 Wackerman [worth, h. 171 Brown
 Nunn Joseph A. jr. brewer, Brown c. Went-
 Nunnold Catharine, grocer, 247 N. Clinton,
 house do. [n. Bloomingdale av.
 Nunnold Henry, blacksmith, h. N. Clinton
 Nunnold Henry, cabinetmaker, 123 Mill, h.
 1 Buchan park
NUNNOLD JACOB, clothing, 1 Front, h.
 N 209 N. Clinton.—*See page 539*
 Nunnold Jacob, 2d, saddlemaker, boards N.
 Clinton near Norton
 Nunnold John, sawyer, 22 S. St. Paul, bds.
 North Clinton near city line
 Nunnold Peter, deceased Jan. 1875
 Nunow William, brakeman, b. 162 North av.
 Nursey Walter F. clerk, 23 Mill, b. 20 Stillson
 Nusbaum Abram, pawnbroker, 91 South St.
 Paul, house do.
 Nusbaum Louis, clerk, 91 S. St. Paul, b. do.
 Nuspickel John, shoemaker, 22 State, house
 7 German [7 German
 Nuspickel John C. shoemaker, 4 Allen, bds.
 Nussbaum Aaron, peddler, house 58 Hanover
 Nussbaum Aaron, removed to San Francisco,
 California
 Nussbaum Meyer, peddler, house 39 Joiner
 Nusbaumer Mary, domestic, boards East av.
 near Arnold park
 Nusser Catharina, widow, house 49 Orange
 Nusser John M. bartender, 137 State, boards
 49 Orange
 Nusslin Fred. physician, 2 Mortimer, h. do.
 Nutt John A. h. 30 Hickory [at New York
 Nutting Andrew J. clothing, 10 State, house
 Nutting Fred P. student, 2 Baker's block,
 boards 110 Genesee [110 Genesee
 Nutting George H. student, 53 Arcade, bds.

Nuttle Philip, groom, boards 7 Otsego
 Nuttle Wm. butcher, boards Lake av. near
 Ridge road
 Nycum Andrew C. removed from city
 Nye James M. brakeman, N. Y. C. R. R.
 house 108 State [av. h. 28 Goodman
 Nyenhuis Abraham, carpenter, rear 54 North
 Nyenhuis Gerrit J. fencemaker, 85 Front,
 house 132 St. Joseph [31 South
 OAKLEY ALFRED, artist, 91 East Main, house
 Oakley A. Mrs. costumer, 31 South, h. do.
 Oakley Barbara B. clerk, boards 12 Oregon
 Oakley Newton, photographer, 91 E. Main,
 boards 31 South [Oregon
 Oakley Charles, clerk, 82 North av. bds. 12
 Oakley George F. collector, Democrat and
 Chronicle, 3 W. Main, h. 81 Monroe av.
 Oakley Joseph L. Y. clerk, bds. 12 Oregon
 Oakley Mary, widow, house 12 Oregon
 Oakley Mary, clerk, boards 12 Oregon
 Oakley Monroe, barber, 107 Plymouth av.
 house Scottsville road, at rapids
 Oakley Sarah, clerk, 131 North av. bds. do.
 Oakley Sylvanus H. boards Scottsville road,
 at rapids
 Oaks Alphonzo A. removed to Dansville
 Oaks George, teamster, house 30 Gregory
 Oaks George, carpenter, N. Y. C. R. R. h.
 36 Atwater
 Oaks George J. supt. 42 State, b. 36 Atwater
 Oaks John F. physician, bds. 86 N. Clinton
 Oaks Lena, milliner, 129 E. Main, bds. 88 N.
 St. Paul
 Oaks, see Ochs [h. Frank c. Lorimer
 Oatley Ebenezer T. city assessor, City Hall,
 Oatley William R. bookkeeper, 64 Mill, bds.
 Frank corner Lorimer
 Obbing Annie, widow, boards 25 Goodman
 Obbing Henry, laborer, house Goodman cor.
 Park avenue [plain
 O'Beirne Charles, stonecutter, b. 188 Cham-
 oberfelder Martin, cashier, 42 State, boards
 33 Clinton place [14 Favor
 Oberg Olof (*Kob & Oberg*), 9 East Main, h.
 Oberholzer Fidelis C. pastor Holy Redeemer
 church, house Hudson cor. Clifford
 Oberle Frank, blacksmith, 3 Canal, boards
 49 North Frances
 Oberlies Damian, butcher, 26 Mumford, h. do
OBERLIES HENRY, carpenter and con-
 tractor, Bond corner Grand, house 27
 Grand.—*See page 637*
 Oberlies Lawrence J. carpenter, b. 27 Grand,
 Oberst Augustus, wool sorter, 37 N. Water,
 house 9 Joiner
 Oberst Charles, peddler, boards 42 Sanford
 Oberst Daniel, hairdresser, 214 West Main,
 boards 30 Elizabeth [N. Clinton
 Oberst Fidel, wool sorter, 37 N. Water, h. 126
 Oberst Fidel B. tinsmith, b. 126 N. Clinton
 Oberst George B. printer, 23 West Main, b.
 126 North Clinton
 Oberst Mary, widow, house 42 Sanford
 O'Brien Ann, widow, house Mansion near
 Magnolia
 O'Brien Anna, widow, house 3 Kirk
 O'Brien Anna, domestic, b. East av. c. Prince

O'Brien Bridget, removed to New York
 O'Brien Bridget, widow, b. 5 Alexander pk.
 O'Brien Bridget Miss, house Mansion near
 Magnolia
 O'Brien Bridget, widow, h. 174 St. Joseph
 O'Brien Catharine, widow, house 48 Frank
 O'Brien Cornelius, tailor, 128 State, bds. do.
 O'Brien Cornelius J. tobacconist, 55 South
 St. Paul, boards 14 Manhattan
 O'Brien Daniel, moulder, rear 204 State, bds.
 174 St. Joseph [Paul, h. 4 Hamilton pl.
 O'Brien Edmund, machinist, 100 South St.
 O'Brien Edward, milkman, b. 2 Woodbury
 O'Brien Edward J. finisher, 2 Hill, boards
 178 Jay
 O'Brien Elizabeth, widow, h. 74 Frost av.
 O'Brien Ellen Mrs. at City Hospital
 O'Brien Fanny, stitcher, boards 26 Locust
 O'Brien Hanorah, widow, house 5 Ely
 O'Brien Humphrey, laborer, h. 50 Tremont
 O'Brien James, laborer, house 131 Saxton
 O'Brien James, laborer, house Childs alley
 near Erie canal
 O'Brien James, pressman, 3 W. Main
 O'Brien James, farmer, h. Lyell near R. R.
 O'Brien James A. bookkeeper, 50 Exchange,
 boards 70 Mt. Hope avenue
 O'Brien James V. removed to New York
 O'Brien Jane M. widow, house 178 Jay
 O'Brien John, laborer, house 14 Manhattan
 O'Brien John, tailor, rear 28 Stone, bds. do.
 O'Brien John, painter, b. Childs near R. R.
 O'Brien John, laborer, house Magne n. R. R.
 O'Brien John B. blacksmith, 2 Ely, house
 222 North St. Paul [h. Chili road
 O'Brien John C. lawyer, 110 Powers' bldgs.
 O'Brien John J. carriage painter, 3 Canal,
 boards 80 West avenue
 O'Brien John T. carpenter, boards 5 Ely
 O'Brien Joseph P. tinsmith, 57 State, bds. 55
 Hamilton place
 O'Brien Lawrence, carpenter, h. 26 Locust
 O'Brien Luke, waiter, Osburn House
 O'Brien Lydia Miss, house 43 Court [av.
 O'Brien Margaret, milliner, b. 70 Mt. Hope
 O'Brien Marica, laborer, h. Culver n. canal
 O'Brien Martin, plumber, 15 West Main
 O'Brien Martin, laborer, Clarissa opp. Ex-
 change, house 20 Champlain
 O'Brien Martin, machinist, h. 172 St. Joseph
 O'Brien Mary, widow, house rear 11 Ely
 O'Brien Mary Miss, stitcher, b. 74 Frost av.
 O'Brien Mary, widow, boards Chili road
 O'Brien Mary, widow, house 20 Cliff [av.
 O'Brien Mary A. dressmaker, b. 70 Mt. Hope
 O'Brien Mary A. widow, bds. 65 North av.
 O'Brien Michael, laborer, house 51 Myrtle
 O'Brien Michael, laborer, h. rear 24 Griffith
 O'Brien Michael, carpenter, boards 26 Locust
 O'Brien Michael, painter, boards 72 Jay
 O'Brien Michael L. confectioner, 50 Ex-
 change, house 70 Mt. Hope avenue
 O'Brien Patrick, laborer, Exchange opposite
 Troup, boards 55 Tremont
 O'Brien Patrick, laborer, 22 South St. Paul,
 house 40 Broadway [pl.
 O'Brien Patrick, salesman, h. 55 Hamilton
 O'Brien Patrick, laborer, house 63 Orchard

O'Brien Patrick, marble polisher, 122 South St. Paul, house 3 Comfort
 O'Brien Patrick J. flagman, Chatham st. R. R. crossing, house 66 Chatham
 O'Brien Terence, laborer, h. 11 Spencer
 O'Brien Thomas, laborer, house 124 Meigs
 O'Brien Thomas jr. maltster, Atwater cor. N. St. Paul, house 26 Warehouse
 O'Brien Thomas, machinist, 100 S. St. Paul, house 2 Hamilton place
 O'Brien Thomas, removed to New York
 O'Brien Thomas E. gasfitter, 25 Exchange, house Bates near Bowen
 O'Brien Thomas J. machinist, 100 S. St. Paul, boards 2 Hamilton place
 O'Brien Timothy, shoemaker, 79 N. Water, boards 174 St. Joseph
 O'Brien William, laborer, house 55 Tremont
 O'Brien William, shoemaker, 15 Mill, house 37 Lewis [h. 106 Caledonia av.
 O'Brien William E. engineer, 45 Fitzhugh,
 O'Brien William S. confectioner, 50 Exchange, b. 70 Mt. Hope av.
 O'Byrne John J. warehouseman, Central Mills, house 34 Kent alley
 O'Callahan Jeremiah, peddler, h. 48 Howell
 O'Callahan John, foreman, house 1 Oakland
 O'Callahan John, laborer, bds. 68 Cypress
 O'Callihan Timothy, carriage builder, 2 Franklin [Moore near Lyell
 Ochs Andrew, cooper, West n. Lyell, house
 Ochs Bernard, boards 278 Brown
 Ochs Frank J. shoemaker, house 6 Morris
 Ochs Joseph, cooper, West n. Lyell, house 40 Campbell [house 72 Frances
 Ochs Nicholas, cooper, Butler corner Charles, Ochs see Oaks
 O'Connell Daniel, laborer, h. Scio n. Huron
 O'Connell Catharine, widow, h. 11 Gorham
 O'Connell James, laborer, b. Hebard n. Huron
 O'Connell Jeremiah, laborer, h. Scio n. R.R.
 O'Connell John, helper, 3 Canal, h. 54 Allen
 O'Connell Mary, widow, house 11 Green
 O'Connell Mary B. dressmaker, b. 13 George
 O'Connell Maurice J. (*Hamilton & O'Connell*), 194 State, house 33 Lyell
 O'Connell Michael, deceased March, 1876
 O'Connell Michael, house 51 Chatham
 O'Connell Michael, laborer, b. Julia n. Troup
 O'Connell Patrick, laborer, h. 9 Brown's al.
 O'Connell Sarah Mrs. house 111 N. Clinton
 O'Connell see Connell
 O'Connor Anna E. copyist, County Clerk's office, boards 32 North Union
 O'Connor Annie, stitcher, bds. 304 State
 O'Connor Bridget, widow, h. 43 Thompson
 O'Connor Bridget, widow, house 39 Grape
 O'Connor Catharine, widow, h. 29 W. Maple
 O'Connor Charles A. wood worker, foot N. Water, boards 5 Manhattan [Paul
 O'Connor Christopher, laborer, b. 31 S. St.
 O'Connor Daniel, fireman, house 13 Lime
 O'Connor Elcanora Miss, dressmaker, b. 39 North St. Paul
 O'Connor Elizabeth, widow, h. 5 Manhattan
 O'Connor Ellen, widow, b. 39 N. St. Paul
 O'Connor Ellen, widow, house 28 Martin
 O'Connor Hugh, cigar maker, b. 23 Lime

O'Connor James (*O'Connor & Kuttruff*), bds. 28 Martin
 O'Connor James, pastor St. Bidget's church, house 39 Hand
 O'Connor James, cartman, house west end Court st. bridge
 O'Connor James, house 63 North avenue
 O'Connor Jeremiah, laborer, h. 26 Sherman
 O'Connor John, saloon, 116 East av. boards 100 do.
 O'Connor John, mason, h. 59 Hamilton pl.
 O'Connor John E. cigar maker, b. 28 Martin
 O'Connor John J. (*O'Connor & Devereaux*), house 36 Rowley
 O'Connor Joseph, laborer, b. 31 S. St. Paul
 O'Connor Julia, gilder, 38 Gorham, h. 26 Sherman
 O'Connor, Margaret, packer, 55 S. St. Paul, boards 97½ East Main [Union
 O'Connor Margaret, dressmaker, h. 32 N.
 O'Connor Martin, laborer, Brown c. Jones, house 34 Orange
 O'Connor Maurice, cooper, b. 43 Thompson
 O'Connor Michael, shoemaker, 111 State, b. 17 Frank
 O'Connor Michael, laborer, bds. 17 Frank
 O'Connor Michael, plasterer, house 67 Pin-nacle avenue
 O'Connor Michael J. plasterer, h. 32 N. Union
 O'Connor Patrick, laborer, Brown c. Jones, house Kent alley near Smith
 O'Connor Stephen, chairmaker, b. 1 Ambrose
 O'Connor Thomas, roadmaster, Erie Railway, house 191 Exchange
 O'Connor Thos. F. cigar maker, b. 28 Martin
 O'Connor Thomas H. switchman, house 43 Thompson
 O'Connor Timothy, laborer, bds. 26 Sherman
 O'Connor William, deceased 1875
 O'Connor Wm. chairmaker, h. 1 Ambrose
 O'Connor Wm. H. carpenter, Opera House, house 1 Manhattan
 O'Connor Winifried, widow, h. 197 Alexander
O'CONNOR & DEVEREAUX (*John J. O'Connor and Nicholas B. Devereaux*), sash, doors and blinds, foot of North Water.—See page 639
 O'Connor & Kuttruff (*J. O'Connor and P. Kuttruff*), stoves and tinware, 55 Monroe avenue
 O'Connor see Connor
 O'Connors Michael, teamster, house 138 Jones
 O'Corr Homer A. sash maker, 153 N. Water, house 1 Conkey avenue
 O'Corr Sheldon, blind maker, house 2 Wait
 O'Corr Wallace A. sash maker, 153 North Water, boards 2 Wait
 Ocumpaugh Edmund & Bro. (*M. Ocumpaugh*), gents' furnishing goods, 17 East Main, and (*J. R. Pentecost & Co.*), house 36 S. Clinton
 Ocumpaugh Moses (*E. Ocumpaugh & Bro.*), 17 East Main, h. 16 Comfort
 Ocumpaugh Rosalia, teacher, b. 16 Comfort
 Ocumpaugh Wallace C. bookkeeper, 1 W. Main, boards 264 North St. Paul
 O'Dea Bridget, widow, house 14 Walnut
 O'Dea John H. machinist, bds. 14 Walnut

- O'Dea Michael F. lawyer, 91 Powers' bldgs. boards 14 Walnut
- Odell George S. house 1 Van [32 Catherine
- Odell Joseph, trimmer, 87 Exchange, boards
- Odell William, oil, house 133 Monroe av.
- Odenbach Fred. stove mounter, 8 Hill, bds. 186 Jay [Chatham
- Odenbach Fred. L. clerk, 49 State, boards 20
- Odenbach James (*Odenbach & Shale*), boards 186 Jay
- O DENBACH JOHN**, hats, caps, furs, &c. 49 State, h. 20 Chatham.—*See page 540*
- Odenbach Peter, shoemaker, house 186 Jay
- O DENBACH & SHALE** (*J. Odenbach and J. G. Shale*), hats, caps, furs, &c., 7 State.—*See page 541*
- Odette Hubert, laborer, house 32 Catharine
- Odette Hubert jr. packer, bds. 32 Catharine
- O'Donaghue Ann, widow, b. 7 Monroe av.
- O'Donaghue John (*P. Burke & Co.*), rear 204 State, house 3 Jay [b. 5 Hand
- O'Donaghue Thomas, moulder, r. 204 State,
- O'Danaghue Timothy, moulder, r. 204 State, house 1 Millers' alley
- O'Donaghue Michael, laborer, house 2 Cliff
- O'Donnell Edmund, blacksmith, Brown cor. Jones, house 128 Jay
- O'Donnell Maria, domestic, 41 Frank North Union
- O'Donnell Patrick, fireman, h. 60½ Bolivar
- O'Donnell Peter, laborer, house Augusta n. North Union
- O'Donoghue Jeremiah, peddler, h. 47 Gregory
- O'Donoghue Bridget, nurse, h. 22 Andrews
- O'DONOUGHUE JAMES & CO.** (*T. B. McKenna*), furniture and house furnishing goods, 42 East Main, h. 31 East av.—*See page 628* [ander
- O'Donoughue Patrick, gardener, h. 116 Alex-Oehmke Frederick, boards 23 Wadsworth
- Oehmke Frederick jr. laborer, house 27 Wadsworth
- Oehmke Herman, laborer, h. 23 Wadsworth
- Oenicke Max, editor Rochester Volksblatt, 18 N. St. Paul, bds. 5 Andrews
- Oertel Bertha Mrs. milliner, 77 North avenue, house do. [h. 62 North av.
- Oeschger Dominick, cabinetmaker, 53 Front,
- Oesterheld Jacob, teamster, house 179 Scio
- Oetlein Bernard, blacksmith, house 141 West Maple
- Oettliker Mary, widow, house 83 Champlain
- Oetzel George, teamster, house 67 Sanford
- Oetzel John, shoe store, 15 South av. h. do.
- O'Farrell Edward J. removed to Addison
- O'Farrell Margaret, widow, b. 111 Champlain
- Offay Mary A. dressmaker, h. 69 Sibley's blk.
- Officer Harriet E. widow, bds. 77 Lake av.
- Ogden Daniel L. agent, 12 Allen, b. 66 South St. Paul [avenue
- Ogden Edwin L. clerk, 36 State, b. 18 East
- Ogden John, melter, house 32 West avenue
- Ogley John, teamster, house 39 Davis
- O'Gorman Andrew, removed from city
- O'Gorman Jennie B. saloon, 114 Lake av. house do.
- O'Grady Ann, saloon, 7 Monroe av. h. do.
- O'Grady Austin, teamster, house 61 Bolivar
- O'Grady Austin jr. laborer, bds. 61 Bolivar
- O'Grady Daniel, clothier, 98 State, house 25 Frank [Frank
- O'Grady Edward L. clerk, 98 State, bds. 25
- O'Grady Jeremiah, boiler maker, h. 8 Otis
- O'Grady Margaret, stitcher, bds. 61 Bolivar
- O'Grady Margaret, widow, h. 112 University avenue
- O'Grady Mary, stitcher, boards 5½ Granger
- O'Grady Michael, laborer, bds. Mill c. Centre
- O'Grady Thomas, fireman, bds. 61 Bolivar
- O'Grady William, screw cutter, 123 Mill, b. Cameron cor. Otis [Main, b. 6 Ward
- O'Halloran Thomas, bookkeeper, 53 East
- O'Hara Bernard, clerk, bds. 40 Champlain
- O'Hara Bryan, millwright, 127 Mill, house 141 Jones [bds. 40 Hunter
- O'Hara Edward, shoemaker, 83 N. Water,
- O'Hara Ellen, widow, house 40 Hunter
- O'Hara Felix, laborer, house 40 Champlain
- O'Hara Hugh, laborer, Platt c. Kent, house 62 Tremont [house 10 Mansion
- O'Hara Hugh, planer, Exchange near Troup,
- O'Hara John. stonecutter, b. 40 Champlain
- O'Hara John, deceased Aug. 1, 1875
- O'Hara Joseph, stovemounter, 20 Court, h. 62 Adams
- O'Hara Martin, stonecutter, b. 11 West av.
- O'Hara Patrick, shoemaker, bds. 40 Hunter
- O'Hara Patrick, laborer, house 60 Hunter
- O'Hara Patrick, carpenter, 97 Exchange, h. 17 Glasgow
- O'Hara R. L. dressmaker, 12 E. Main, b. do.
- O'Hare Daniel, laborer, house 69 Davis
- O'Hare James F. pastor St. Patrick's Cathedral, house 42 Frank
- O'Hare John, clerk, boards 29 Gibbs
- O'Hare John F. gasfitter, 8 Mumford, boards 65 Joiner
- O'Hare Michael, house 126 Frank
- O'Hare Thomas A. physician, 125½ State, b. 126 Frank [n. W. Main
- O'Harra Thomas, laborer, house West alley
- O'Hearn David, laborer, house 8 Thompson
- Ohr David F. manager for Gaff, Fleischmann & Co. 156 East Main, b. 5 East Main
- O'Kane Alfred, carriage maker, h. Reynolds corner Atkinson [Kinson
- O'Kane Eliza, widow, h. Reynolds cor. At-
- O'Kane Bernard (*O'Kane Bros.*), bds. Frances corner Flint [market, 78 Bartlett
- O'Kane Brothers (*B. and W. H. O'Kane*),
- O'Kane James, shoemaker, 91 North Water, boards Frances cor. Flint
- O'Kane James, conductor, elevator Powers' bldgs. b. 14 Flint [b. 34 Reynolds
- O'Kane James A. carriage maker, 3 Canal,
- O'Kane John, house Frances corner Flint
- O'Kane John, engineer, Powers' bldgs. basement, house 53 Edinburgh
- O'Kane John jr. removed to Chicago, Ill.
- O'Kane Joseph, deceased Nov. 26, 1875
- O'Kane Peter, laborer, bds. rear N. Clinton near Norton [lett, b. Frances c. Flint
- O'Kane William H. (*O'Kane Bros.*), 78 Bart-
- O'Keefe Andrew E. clerk, 2 Arcade, bds. 73 West Maple

O'Keefe Arthur, grocer, 204 State, house do.
 O'Keefe Daniel H. painter, b. 73 W. Maple
 O'Keefe Edward, paver, boards Cottage near
 Plymouth avenue
 O'Keefe Jennie, dressmaker, bds. 39 Lyell
 O'Keefe John, laborer, rear 48 South avenue
 house 175 South St. Paul
 O'Keefe John, laborer, house 104 Tremont
 O'Keefe Margaret, dressmaker, 39 Lyell, h. do.
 O'Keefe Margaret, saloon, 73 W. Maple, h. do.
 O'Keefe Michael, blacksmith, 277 State, h.
 39 Lyell [62 Exchange
 O'Keefe Patrick, shoemaker, 14 State, bds.
 O'Keefe Sarah C. Miss, teacher, Central
 School, No. 5, boards 8 Atkinson
 O'Keefe Thomas, laborer, h. 104 Tremont
 O'Keefe Thomas, file grinder, River n. N.
 Water, h. Kelly cor. St. Joseph
 O'Keefe William C. removed to West Meri-
 den, Conn.
 O'Kelly Thomas P. lawyer, 16 Powers' bldgs.
 boards do. [Main, h. '7 Emerson
 Olcott James B. (*Reibling & Olcott*), 62 East
 Oldfield Bridget, widow, house 94 Frank
 Oldfield John, moulder, rear 204 State, house
 36 Lake avenue
 Oldfield Margaret Mrs. fancy goods, 36 Lake
 avenue, house do. [Brown's alley
 Oldfield Nicholas, fireman, 61 Front, h. 32
 Oldfield Thomas, laborer, house 44 Orchard
 Oldfield Wm. fireman, house 94 Frank
 O'Leary Daniel, carpenter, b. 49½ Thompson
 O'Leary Dennis A. laborer, boards 6 Munger
 O'Leary Jeremiah, laborer, house 6 Munger
 O'Leary Jeremiah plasterer, h. 49½ Thompson
 O'Leary John, coachman, 2 Livingston pl.
 boards do. [near Bates
 O'Leary John, canal lock tender, b. Bowen
 O'Leary Joseph, laborer, boards 6 Munger
 O'Leary Margaret, widow, house 90 Scio
 O'Leary see Leary
 Olheiser Joseph, laborer, house 14 Philander
 Olin Hiram B. student, University of Roch-
 ester, boards 23 Andrews
 Olin Phebe M. Mrs. 8 E. Main, house 18 do.
 Olin Richard M. car builder, 159 State, h. 18
 East Main [Ridge road, h. do.
 Olive George, harness maker, Lake av. near
 Oliver Bridget Miss, house 27 Lancaster
 Oliver Elizabeth J. Miss, bds. 54 Alexander
 Oliver George, carpenter, h. 8 Alexander
 Oliver Henry, foreman, 44 Exchange, house
 441 Brown
 Oliver John B. carpenter, house 42 Thomas
 Oliver John H. boards 42 Thomas
 Oliver Mary Miss, nurse, boards 17 Montrose
 Oliver Older, policeman, City Hall, house
 127 Broadway
 Oliver Peter, teamster, house 57 Lime
 Oliver Thomas, foreman, h. 49 Alexander
 Oliver Wm. bookkeeper, 3 W. Main, house
 27 University av.
 Oliver William S. (*Martindale & Oliver*), 42
 Powers' bldgs. b. 82 Plymouth avenue
 Olman Catharine, widow, bds. 46 South av.
 Olmstead Freeman E. house 133 West avenue
 Olmsted Anson W. clerk, 17 State, house 451
 Brown

Olmsted Edward P. (*Olmsted & Stracham*),
 house 17 Franklin
 Olmsted George, salesman, h. 35½ Glasgow
 Olmsted Harry A. justice, h. Lake av. near
 Ridge road
 Olmsted Wm. G. removed to Canada
 Olmsted Wm Seymour, bookkeeper, 42 Ex-
 change, house 230 do.
 Olmsted W. Howard (*McNaughton & Olmsted*),
 21 Arcade, boards Brackett House
 Olmsted & Strachan (*E. P. Olmsted and D.
 Strachan*), fancy goods, 95 East Main
 Olney Amasa R. stabler, house 15 Scantom
 Olney Oliver A. carpenter, house 40 Romeyn
 O'Loughlin Andrew, foreman, 72 State, h.
 27 Kent
 O'Loughlin Edward, foreman, Water Works,
 house 9 Edinburgh [block
 O'Loughlin Edward, laborer, h. 56 Brown
 O'Loughlin Ellen, widow, house 24 Frank
 O'Loughlin James, fireman, N. Y. C. depot,
 house 1 Campbell [21, 1875
 O'Loughlin James P. deceased December
 O'Loughlin John, grocer, 147 Brown, h. do.
 O'Loughlin John, fireman, bds. 11 Ontario
 O'Loughlin John, sawmaker, 153 State, b.
 76 Smith
 O'Loughlin John, laborer, house 2 Erie
 O'Loughlin Lawrence, fireman, h. 11 Ontario
 O'Loughlin Margaret Mrs. house 92 Smith
 O'Loughlin Mary, widow, house 76 Smith
 O'Loughlin Michael C. cigar maker, 48 Ex-
 change, boards 24 Frank
 O'Loughlin see McLaughlin
 Olsen Ole A. removed to Onawa Iowa
 O'Maley James B. file maker, h. 130 North av.
 O'Marra Catharine, widow, h. 65 Pinnacle av.
 O'Meara Julia, widow, house 17 Savannah
 O'Meara Mary, widow, house 37 Platt
 O'Meara Michael, fireman, b. 17 Savannah
 O'Meara Patrick, house 28 South
 O'Meara Patrick F. marble cutter, boards 17
 Savannah
 Omish Elizabeth, nurse, Rochester Orphan
 Asylum, boards do.
 O'Neil Arthur, laborer, h. Sibley n. Culver
 O'Neil Arthur, Hook and Ladder No. 1, 61
 Front, boards do. [House
 O'Neil Daniel, supt. hose, 61 Front, b. York
 O'Neil Edward, boards 126 Frank
 O'Neil Edward J. (*O'Neil & Dempsey*), 342
 State, boards 126 Frank
 O'Neil James, gardener, h. Sibley n. Culver
 O'Neil James F. printer, 82 West Main, house
 34 Alexander
 O'Neil James T. tailor, 17 Front, house 11
 Tappan
 O'Neil John, laborer, boards 136 S. St. Paul
 O'Neil John, laborer, house 11 Lind
 O'Neil John, coachman, 107 Fitzhugh, b. do.
 O'Neil Nettie Mrs. house 2 Briggs' block
 O'Neil Owen, carpenter, house Cottage near
 Plymouth avenue
 O'Neil Patrick, laborer, house 79 Magne
 O'Neil Sarah, milliner, boards 20 Cliff
 O'Neil Timothy, laborer, house 132½ Jay
 O'Neil Wm. coachman, bds. 78 S. St. Paul
 O'Neil ———, laborer, h. Brown n. State

O'NEIL & DEMPSEY (*E. J. O'Neil and J. Dempsey*), liquors, wines, &c. 342 State.
—See page 562

O'Neill Ann, widow, house 78 Frank
O'Neill Cornelius, tanner, 87 N. Water, bds. Mill c. Centre
O'Neill Edward C. mason, boards 78 Frank
O'Neill Frederick, grocer, 36 South St. Paul, house 13 South
O'Neill John, laborer, house 11 Vincent pl.
O'Neill John, removed to Greece
O'Neill Joseph, shoemaker, 83 N. Water, b. 78 Frank
O'Neill Mary Miss, boards 76 Weld
O'Neill Patrick, laborer, boards 102 Mill
O'Neill P. Wm. policeman, City Hall, house 8 Litchfield
O'Neill Thomas, boards 78 Frank
O'Neill Wm. laborer, h. 137 Saxton n. R. R.
O'Neill Wm. publisher, house 182 E. Main
O'Neill William, house 13 South
O'Niel Charles, teamster, b. 156 N. Clinton
O'Niel John, cooper, Smith c. canal, house 19 Vincent place
Ontario Iron Company, 90 Mill
Onthank George H. machinist, house 8 King
Oothout John W. house East av. n. Goodman
Oothout Samuel N. & Son (*W. N. Oothout*), maltsters, Mt. Hope av. c. canal, house 59 North avenue [Webster road
Oothout S. Henry, farmer, h. Culver near Oothout William N. (*S. N. Oothout & Son*), and Treas. Roch. Brewing Co. ft. Cliff, h. East av. n. Vick pk. [house do.
Oppel George, baker, 220 North Clinton, Oppenheimer Myer, house 22 St. Joseph
Orange Abram, finisher, 74 State, house 131 North Clinton
Orange Johanna S. widow, b. 131 N. Clinton
Orb John, brewer, 139 North St. Paul, b. do.
Orchard John, laborer, house 78 Weld
Orchard Mary, dressmaker, 27 S. Ford, h. do.
Orchard William E. tool handler, 136 Mill, boards 78 Weld
Orcutt Amba, wood worker, h. 70 Hamilton avenue [20 Scrantom
Ordway Wm. millwright, 13 S. Water, h.
O'Regan John C. lawyer, 71 Arcade, bds. 6 Ward [1 Shamrock
O'Regan Margaret, gilder, 38 Gorham, house
O'Regan Mary, widow, b. 98 N. St. Paul
O'Regan Mary A. widow, house 80 Pearl
O'Reilly Ann, widow, boards 24 Leopold
O'Reilly Bernard, undertaker, 127 State, house 66 Frank
O'Reilly Bridget, widow, house 11 Green
O'Reilly Celia, nurse, house 33 Orange
O'Reilly Geo. gardener, house 49 Platt
O'Reilly Jas. grocer, 111 Champlain, h. do.
O'Reilly James P. removed to Chicago
O'Reilly Miles T. clerk, 127 State, boards 66 Frank
O'Reilly Patrick, b. 66 Frank [Frank
O'Reilly Patrick J. clerk, 127 State, bds. 66
O'Reilly Thomas, foreman, h. Field n. Erie Canal
O'Reilly Thomas, paper hanger, 52 E. Main, boards 135 South St. Paul

O'Reilly see Riley [Galusha
Oren Charles, cabinetmaker, 2 Hill, house 20
Oriell Chas. E. salesman, b. 151 University av.
Oriell Eliza Miss, h. 151 University avenue
Oriell Frederick, agent, house 3 Lorimer
Oriell Mary, widow, h. 151 University avenue
O'Riley John, teamster, State c. Platt, b. 54 Thompson
O'Riley Michael, laborer, h. 54 Thompson
O'Riley Patrick, carpenter, b. 54 Thompson
Orlup Wesley, mason, house 25 Tappan
Ornstein Lewis, clerk, 62 Front, boards York House
O'Rorke Bernard, moulder, house 22 Emmett
O'Rorke Bertie Miss, teacher, Atwater School, No. 10, boards 19 Emmett
O'Rorke Mary, widow, house 19 Emmett
O'Rorke Thomas, carpenter, 97 Exchange, house 21 Grand
O'Rorke Thomas, laborer, house 21 Emmett
O'Rorke Thomas F. salesman, 53 E. Main, boards 21 Emmett [11 Tonawanda
O'Rourke Hugh, moulder, 187 W. Main, h.
O'Rourke John, watchman, h. 55 Park av.
Orr Sarah, widow, house 35 Manhattan
Ort Ross, laborer, house Scrantom n. North Clinton
Ortelee Marcus, tailor, house 20 Clifford
Orth Charles W. tailor, 10 Cayuga pl. h. do.
Orth Elizabeth, widow, house 1 Thompson
Ortner Barbara, widow, h. 118 St. Joseph
Osborn Aaron, baggageman, h. 20 Oregon
Osborn Ann, widow, house 88 Tremont
Osborn Charles, salesman, 13 East Main, house 36 Court
Osborn Charles, boards 20 University avenue
Osborn Charles T. clerk, 2 Mumford, boards 20 Oregon [donia avenue
Osborn Ellen J. Mrs. nurse, house 55 Cale
Osborn George N. clerk, 25 Exchange, bds. 13 Stone [av. h. 67 Asylum
Osborn James, truss hoopmaker, r. 62 East
Osborn John D. baker, 147 East Main, h. do.
Osborn John W. surveyor, b. 147 East Main
Osborn John W. jr. principal, Monroe School, No. 15, boards 6 Newton block
Osborn Nathaniel P. house 18 South Clinton
Osborne Edward, salesman, 53 East Main, house 87 Meigs
Osborne George J. assistant priest, St. Patrick's Cathedral, house 42 Frank
Osborne Lester, printer, 87 State, house 235 East Main [house 6 Bolivar
Osborne Walton J. salesman, 19 Warehouse,
Osborne William E. tinsmith, h. 103 Gregory
Osborne William E. gasfitter, h. 28½ Comfort
Osborne William H. laborer, b. 28½ Comfort
Osburn Decorous C. boards 1 East avenue
Osburn Emery W. boards 1 East avenue
Osburn Nehemiah, contractor, h. 1 East av.
Osgood Lucretia N. Mrs. b. 12 Pinnacle av.
Osgood Howard, professor, Roch. Theological Seminary, boards 23 East avenue
Osgood Josephine Miss, house 19 Swan
Osgood Rufus F. patent solicitor, 49 Arcade, house North St. Paul c. Scrantom
Osgood W. Scott (*Osgood & Farley*), house 21 South Washington

- Osgood & Clark (*W. S. Osgood and D. R. Clark*), paints, glass, oils, &c., 4 Front
- Osgoodby William W. (*Osgoodby & Duffield*), house 18 Fitzlugh
- Osgoodby & Duffield (*W. W. Osgoodby and W. F. Duffield*), law reporters, 133 Powers' buildings [house do.]
- O'Shaughnessy Edward, saloon, 89 Front,
- O'Shaughnessy Edward, laborer, h. 1 Kirk
- O'Shaughnessy John, laborer, Exchange opp. Troup, house 1 Garden
- O'Shaughnessy John H. coachman, 53 Plymouth avenue, b. 112 Mt. Hope avenue
- O'Shaughnessy Margaret, dressmaker, 112 Mt. Hope avenue, boards do.
- O'Shaughnessy Patrick R. coachman, 77 Plymouth av. h. 112 Mt. Hope avenue
- O'Shaughnessy Thomas, boards 89 Front
- O'Shea Edward L. shoemaker, 77 North Water, boards York House
- O'Shea Elizabeth, widow, house 99 Allen
- O'Shea John W. clerk, 71 North Clinton, b. 99 Allen
- O'Shea Margaret, sewer, boards 99 Allen
- O'Shea Mary, seamstress, boards 99 Allen
- Osiar Louis, teamster, Flour City Mills, h. rear 342 State [house 100 Jay
- Osman John, cooper, Smith cor. Erie canal,
- Ost John, sawyer, Hydraulic bldgs. h. 4 Dover
- Oster Charles, shoemaker, house 66 Lowell
- Oster Jacob, shoemaker, house 52 Scrantom
- Oster Jacob H. shoemaker, River n. North Water, house 82 Atwater
- Oster John, turner, 186 State, h. 109 Chatham
- Oster John jr. turner, Jay corner Erie canal, boards 109 Chatham
- Oster Magdalena, widow, boards 82 Atwater
- Osterhoudt John D. salesman, bds. National Hotel
- Ostertag Albert, whipmaker, Allen near N. Washington, boards 13 White
- Ostertag Charles, glassengraver, 118 Mill, h. 13 White
- Ostrand Frank, brakeman, boards 168 North
- Ostrander Albert, cabinetmaker, h. 40 Rhine
- Ostrander Alvah M. printer, 14 State, h. 126 University av. [126 University av.
- Ostrander Charles M. printer, 14 State, bds.
- Ostrom John G. clerk, 17 S. St. Paul, b. do.
- O'Sullivan Timothy, teamster, 102 Exchange, house 17 Almira [41 Ontario
- Oswald Aton, brewer, 106 N. Clinton, h.
- Oswald Frederick J. shoemaker, 79 N. Water, house 5 Montrose
- Oswold Geo. B. shoemaker, 101 Hudson, b. do.
- Oswold Oluf, boots and shoes, 101 Hudson, house do. [Chestnut
- Otis Elizabeth, music teacher, boards 24
- Otis George T. architect, 102 Powers' bldgs. boards Lyell road, Cates
- Otis Harrison G. agent, Express Printing Co. 23 West Main, house 94 South avenue
- Otis Ira L. supt. Rochester Brick & Tile Co. and (*Otis & Gorsline*), 51 Powers' bldgs. house 136 Alexander
- Otis Lyman M. (*Chase & Otis*), h. 55 Chestnut
- Otis Marvin E. (*M. S. & M. E. Otis*), 129 Mill, house 58 Kirk
- Otis Marvin S. & M. E. pulp manufs. 129 Mill, house 22 Stillson
- O**TIS & GORSLINE (*I. L. Otis and W. H. Gorsline*), sewer pipe manufs. 51 Powers' bldgs.—See page 655
- O'Toole Mary Ann, servant, boards 306 State
- Ott Albert M. boxmaker, house 16 Marion
- Ott Conrad, laborer, house 104 Hudson
- Ott Frederick, porter, 24 State, house 104 Hudson
- Ott Longin, tailor, house 13 University av.
- Ottman Joseph, market, 30 Front, house do.
- Ottnat Albert, clerk, boards 43 Meigs
- Ottnat John jr. carpenter, boards 43 Meigs
- Ottnat John A. deceased Nov. 1875
- Ottnat Maria T. widow, house 43 Meigs
- Otto Adolphus H. clerk, 115 State, bds. 13 Frank
- Otto Catharine, boards 10 Mortimer
- Otto Frank X. teamster, house 19 Smith
- Otto Frederick, watches, clocks, &c. 115 State, house 13 Frank [11 Shamrock
- Otto Frederick, laborer, 162 S. St. Paul, bds.
- Otto Henry, tailor, 58½ Smith's block, house 10 Mortimer [10 Mortimer
- Otto Henry F. tailor, 6 Exchange place, bds.
- Otto Herman, laborer, h. 27 McDonald av.
- Otto John J. tailor, boards 10 Mortimer
- Otto Joseph A. grocer, 136 N. St. Paul, h. do.
- Otto Joseph R. lithographer, 7 Market, boards 10 Mortimer
- Ottow Dorothea, widow, b. 49 Monroe av.
- Ottoway Edmund R. machinist, 100 S. St. Paul, boards 68 do. [280 N. Clinton
- Outler Carl, tobacconist, 23 West Main, h.
- Outwater Hannah, widow, house 12 Harvard
- Outwater Theron, student, Roch. Theological Seminary, bds. 12 Harvard
- Ovenburg Anna, tailoress, b. 21 Hoeltzer
- Ovenburg Jacob, sawyer, house 15 Martin
- Ovenburg Joseph, shoemaker, b. 21 Hoeltzer
- Ovenburg Roman, saloon, 1 Lowell, h. do.
- Ovenburg Roman, laborer, h. 21 Hoeltzer
- Overst Fidel B. tinsmith, 72 West av. bds. 126 North Clinton
- Oviatt Caroline E. Mrs. house 13 Howell
- Oviatt Charles W. watchmaker, 5 State, h. 5 Fulton av.
- Oviatt Elias W. clerk, bds. 169 Monroe av.
- Oviatt Eugene A. clerk, 62 State, house 11½ Comfort
- Oviatt Melancthon B. boards 58 S. St. Paul
- Oviatt Mortimer H. boards 13 Howell
- Oviatt Philo S. miller, Jefferson mills, boards 13 Howell
- Oviatt Rosillie D. widow, house 9½ Comfort
- Oviatt Selden H. foreman, h. 169 Monroe av.
- Oviatt Wilton D. clerk, 62 State, h. 47 Hamilton pl. [av. h. 60 Asylum
- Owen Charles, carpenter, Franklin c. North
- Owen Edward G. baker, 104 Plymouth av. house 12½ Edinburgh
- Owen Elizabeth, widow, house 51 N. Union
- Owen Gilson, deceased April, 1876
- Owen Henry, machinist, 100 S. St. Paul, boards 11½ Stone
- Owen Julia A. widow, house 90 North av.
- Owen Orange, house 6 Comfort

Owen Polly, widow, house 11½ Stone
 Owen Wilbur F. bookkeeper, 69 State, house
 149 Fitzhugh [37 Nassau
 Owen William R. engineer, N. Y. C. R. R. h.
 Ovenden Thomas, waiter, Osburn House
 Owens Annie, shoecutter, bds. 84 North av.
O WENS CHARLES C. manager Mercantile
 agency, 15 Exchange, house 30 Park
 avenue.—See page 692
 Owens Francis, clerk, 15 Exchange, boards
 30 Park avenue
 Owens Nelson G. engineer, N. Y. C. R. R.
 house Hoelfer near North Clinton
 Owens Sibley, engineer, 73 East Main, house
 21½ Stone [bds. 36½ Lyell
 Oowler Frank M. carriage painter, ft. Centre,
 Oxley William N. salesman, 50 Front, bds.
 Ayer's Hotel
PACAUD ALBERTUS M. A. grocer, 92 Kelly,
 house do.
 Pace Mary, widow, house 48 Franklin
 Pace Stephen C. deceased August, 1875
 Pack John F. shoecutter, 55 Mill, h. 96 Strong
 Packard Charles H. watchmaker, Court cor.
 Stone, boards 42 Court
 Padiera George, physician, Franklin cor. N.
 St. Paul, house do.
 Padley Alfred, bookkeeper, house 22 Bloss
 Padley Charles A. clerk, water works, City
 Hall, boards 195 Exchange
 Padley James, builder, 195 Exchange, h. do.
 Padley John H. clerk, 8 Arcade, h. 97 Mt.
 Hope avenue [16 N. Clinton
 Padten Charles E. shoemaker, 15 Mill, bds.
 Padula Felix, peddler, h. 126 North Water
 Page Anna M. widow, house Lakeview
 Page Anna R. teacher Munger School, No.
 13, bds. 13 Comfort [Main, b. 14 Elm
 Page Charles W. traveling agent, 53 East
PAGE CLARK D. water wheel motor, and
 evaporating stand, house 17 East.—See
 page 694 [48 Charlotte
 Page David P. box maker, ft. Centre, house
 Page Elizabeth, widow, house 51 North av.
 Page Frank W. (*G. B. Page & Son*), boards
 152 Alexander
 Page George, car inspector, N. Y. C. R. R.
 depot, house 13 Comfort
PAGE GEORGE B. & SON (*F. W. Page*),
 harness and collar manufs. 98 E. Main,
 house 152 Alexander.—See page 609
 Page George T. laborer, boards Lakeview
 Page George W. plumber, bds. 13 Comfort
 Page James blacksmith, rear 145 E. Main, h.
 51 North avenue
 Page John, gardener, boards 68 Cypress
 Page John H. laborer, house 4 Bartlett
 Page Louisa Mrs. boards 35 Tremont
 Page Otis G. clerk, 98 East Main, boards 152
 Alexander
 Page Thomas, drover, boards 12 Adams
 Page William A. mason, boards 17 East
 Page William M. tinsmith, 244 State, boards
 22 Ontario
 Pagels Henry, laborer, house 42 Sellinger
 Pagels Joseph, teamster, Ifooker's Nursery,
 house East av. near Union

Pagles Theodore, finisher, 73 State, bds. 42
 Sellinger
 Paglow John, laborer, h. Livingston n. N.
 St. Paul [Bernard
 Paign Wm. carpenter, boards Hudson near
 Paine Charles H. laborer, 49 N. Clinton, b.
 12 Leopold
PAINE CYRUS F. & CO. (*L. C. Paine and
 A. S. Lane*), druggists, 20 and 22 W.
 Main, house East av. opp. Meigs.—See
 front cover
 Paine Lemuel C. (*C. F. Paine & Co.*), 20 and
 22 West Main, house do.
 Paine Philemon B. driver, house 13 Hunter
 Paine Roswell B. house 12 Leopold
 Paine Seth W. removed to Ontario, Canada
 Paine Theodore S. (*Paine & Mills*), boards
 12 Leopold
 Paine Zina B. waiter, Congress Hall, b. do.
PAINE & MILLS (*T. S. Paine and W. H.
 Mills*), grocers, 49 N. Clinton c. Andrews.
 —See page 555
 Paine, see Payne
 Painter James, driver, 127 State, h. 131 do.
 Painter Robert, laborer, house 128 Lake av.
 Paisley James, brakeman, Erie railway, h. 7
 Eagle [42 North av.
 Palen Leroy G. salesman, 53 East Main, bds.
 Palland Frank shoemaker, 227 East Main,
 house 71 Charlotte
 Pallas Charles, laborer, h. 25 McDonald av.
 Palles Carl, laborer, house 24 McDonald av.
 Pallett William, market, 3 Hunter, h. r. 129
 Caledonia av.
 Palm Jacob, safe maker, house 47 Lincoln
 Palmer Aaron, inventor, house 16 Vick pk.
 Palmer A. Porteus, bookkeeper, Lake av.
 corner Lyell, house 6 Bloss
 Palmer Benjamin R. (*Jones & Palmer*), Locust
 near Fulton avenue, house at Greece
 Palmer Caroline H. widow, boards 2 George
 Palmer Charles E. sash maker, 15 Ware-
 house, boards 200 Brown
 Palmer Charles H. clerk, Traders' National
 Bank, boards 305 East Main [William
 Palmer Charles K. painter, 12 Stone, bds. 21
 Palmer Charles W. 46 Exchange, h. 63 Meigs
 Palmer Christian, laborer, h. 17 Philander
 Palmer C. Edwin, boards 63 Meigs
PALMER DWIGHT. fish and oysters, 76
 Front, boards York House.—See back
 colored page [h. 64 Lancaster
 Palmer Edward, clerk, 6 Railroad avenue,
 Palmer Edwin, foreman, 15 Warehouse, h.
 200 Brown
 Palmer Edwin C. clerk, boards 63 Meigs
 Palmer Elizabeth, widow, house 5 Summer
 Palmer Franklin D. (*N. S. Palmer & Son*),
 boards 187 West avenue [House
 Palmer George, clerk, 76 Front, boards York
 Palmer George, clerk, boards 62 Court
 Palmer George C. iron worker, 85 Front, h.
 10 Waverley place
 Palmer George E. house 48½ Caledonia av.
 Palmer George W. clerk, 10 Exchange, bds.
 62 Court
 Palmer Gertrude, widow, bds. 84 West av.
 Palmer Henry, boards 248 State

Palmer Henry J. clerk, 93 State, house 12 George's park
 Palmer Horace A. house 118 Oak
 Palmer Isaac, vice-president Ontario Iron Co. 90 Mill, h. at Brockport [h. 305 do.
 Palmer James, pyrotechnist, 140 East Main,
 Palmer James jr. pyrotechnist, 305 E. Main, boards 62 Court [boards 23 East av.
 Palmer John P. lawyer, 117 Powers' bldgs.
 Palmer Joseph W. pyrotechnist, 305 E. Main, boards 62 Court
 Palmer Margaret, widow, h. 14 S. St. Paul
 Palmer Nathan, house 51 East avenue
PALMER NATHANIEL L. & SON (F. D. Palmer), coal, 83 Allen, h. 187 West av. corner Brigg's place.—See page 598
 Palmer Norman, clerk, 36 State, boards 9 Elizabeth
 Palmer Pamela, widow, boards 22 Bolivar
 Palmer Peter, produce dealer, house 20 University avenue
 Palmer Stuart C. agent, boards 37 Stone
PALMER THOMAS G. iron fence and bolt manuf. 87 Front, h. 20 Oak.—See page 662
 Palmer Truman G. engineer, b. 187 West av.
 Palmer William H. bookkeeper, 28 West Main, boards 27 Madison
 Palmer Wm. H. bartender, h. 48 Franklin
 Palmer Wm. L. agent, 50 Arcade, boards Chapman House [St. Paul
 Palmeter Edgar A. clerk, 31 State, b. 27 N.
 Pancost Julia, widow, house 4 Fitzhugh
PANCOST, SAGE & MORSE (Wm. N. and E. O. Sage, O. C. Morse and J. L. Sage), boot and shoe manufs. 92 State.—See page 663 [White alley
 Pangburn Lydia, widow, boards Perkins c.
 Pangburn George C. removed to Greece
 Papenhausen William, student, Rochester Theological Seminary, boards 40 Meigs
PAPPERT AUGUST, mason and contractor, h. 110 Pinnacle av.—See page 641
 Pappert Vincent, mason, h. 110 Pinnacle av.
 Paradis Antoine, saloon, 30 West av. house 53 Tremont
 Paradis Geo. E. stove mounter, 20 Court, b. 45 Stone [45 Stone
 Paradis Remi, pattern fitter, 20 Court, house
 Paradis L. Napoleon, tailor, bds. 40 Walnut
 Paradise Nathan K. stone cutter, boards 96 S. St. Paul
 Pardee Charles L. deceased September, 1875
 Pardee Ensign B. physician, 49 North av. boards do. [ward pk.
 Pardee Henry, laborer, h. St. Joseph n. Hay
 Pardee Margaret P. widow, boards 105 Scio
 Pardee William, trimmer, 111 State, bds. 12 North Washington
 Paris John, machinist, house 51 Sherman
 Parish Edwin O. brakeman, N. Y. C. R. R. boards 9 North Frances
 Parish Isaac, photographer, h. r. 307 State
 Parish Mark, photographer, 58 State, b. rear 307 State
 Parish, see Parrish [11 Vienna
 Park George, machinist, Court cor. Stone, h.
 Parker Elizabeth Mrs. house 77 Hunter
 Parker Frank A. clerk, 40 Allen, bds. 69 do.

PARKER HASKELL D. carpenter and contractor, h. 63 Broadway.—See page 635
 Parker Hiram J. bookkeeper, h. 1 Edmonds
 Parker Irving W. (Lewis & Parker), house 13 Conkey avenue
 Parker John, clergyman, house 2 Elm
 Parker Josiah, carpenter, house 8 Lancaster
 Parker Mary, widow, house 12 Vine
 Parker Melvin O. furniture, 13 West av. h. do.
 Parker Milford C. clerk, 41 Front, house do.
 Parker Samuel J. machinist, r. 136 Mill, h. 122 Caledonia avenue [way
 Parker Theodore H. carpenter, b. 63 Broadway
 Parker William H. tinsmith, bds. 7 Vought
 Parker William J. ass't bookkeeper, Court cor. Stone, house 36 Vick park
 Parker William J. carpenter, h. 54 Hanover
 Parker Wm. J. jr. carpenter, h. 32 Hanover
 Parkes Eliza, widow, boards 4 Frederick
 Parkes Lydia A. forewoman, b. 4 Frederick
 Parkes Rowland, bookkeeper, 38 Gorham, house 36 Galusha
 Parkhill William S. fireman, house 37 Jones
 Parkhurst George B. carpenter, b. 24 Sophia
 Parkhurst Henry, carpenter, h. 24 Sophia
 Parkhurst Mary, physician, 24 Sophia, h. do
 Parkhurst Wm. foundryman, b. 132 North
 Parkhurst Wm. A. hackman, h. 299 State
 Parkinson Jane E. nurse, 111 Monroe av.
 Parkinson Mary A. widow, h. 133 Hunter
 Parks Henry, salesman, house 88 Reynolds
 Parks Henry, painter, 9 West Main, house 135 Hudson
 Parks Samuel H. whipmaker, bds. 20 White
 Parliaman Florence A. portraits, 171 Powers' bldgs. boards 28 Court
 Parmale Almira, widow, bds. 10 Rhine
 Parmale William H. tanner, 37 N. Water, h. 4 Johnson pk. [arsenal, h. 52 William
 Parmalee Frederick W. armorer, N. Y. State
 Parmalee John W. salesman, 50 Mill, house 98 North avenue
 Parmalee W. Frank, carriage painter, 35 S. St. Paul, bds. 115 Monroe avenue
 Parmelee Charles H. shoemaker, 87 North Water, boards 5 North Washington
 Parmele Jane, widow, boards 98 North av.
 Parmele John W. agent, house 98 North av.
 Parmelee William I. clerk, 73 East Main, b. 36 Pearl [do.
 Parmely Almira, watchmaker, 37 Stone, h. Parmely Daniel, deceased October, 1875
 Parmenter Edgar, lawyer, b. 27 N. St. Paul
 Parmenter Lydia, boards 27 South avenue
 Parrish William A. clerk, 123 State, boards 70 Clifton [Caroline
 Parry Charles A. shoemaker, 124 Front, h. 3
 Parry George F. engineer, N. Y. C. R. R. h. 82 Hudson [house do.
 Parry John, shoemaker, 116 Plymouth av.
 Parry John jr. artificial limbs, 111 Arcade, house 8 Weld
 Parry Joseph, fireman, house 258 North
 Parry Thomas, coupler, house Fourth av.
 Parry William F. mason, house 4 Prospect
PARSELS WILLIAM W. merchant tailor, 12 West Main, h. 30 Monroe av.—See page 536

HENRY C. WISNER,

WHITE CHINA DINING and TEA SETS, No. 33 STATE STREET.

Parshall Clarence S. tailor, 53 East Main, boards 135 North avenue
 Parshall Daniel S. tailor, 55 East Main, house 135 North avenue [N. Clinton
 Parshall George W. paperhanger, boards 67
 Parshall John, special police, h. 38 Atwater
 Parshall Nelson C. principal, Wadsworth School, No. 12, bds. 32 South Clinton
 Parshall Stockton T. eating house, 1 Anderson avenue near University avenue
 Parson Josiah C. jeweler, house 26½ Favor
 Parsons Ada R. dressmaker, h. 10 Glasgow
 Parsons Alzina G. teacher, boards 54 S. Ford
 Parsons Anna E. Miss, bds. 14 Franklin sq.
 Parsons Ansel C. insurance agent, 92 Powers' bldgs. house 3 University avenue
 Parsons Benj. F. patent agent, 92 Powers' bldgs. boards 169 East Main
 Parsons Charles B. civil engineer, City Hall, boards 97 Alexander
 Parsons Chauncey, house 2 Clarissa
 Parsons Clifford W. correspondent, boards 97 Alexander
 Parsons Cornelius R. house 6 Arnold park
 Parsons Edwin A. agent, b. 3 University av.
 Parsons Erastus, bookkeeper, house 1 Anderson avenue [Bartlett
 Parsons Eugene D. W. clerk, 103 State, h. 91
 Parsons Ezra M. h. Chili road near West av.
PARSONS E. B. sec'y Rochester Driving Park, 3 Smith's block, and malt house, Brown corner Warehouse, boards Osburn House.—See page 561
 Parsons Frank G. boards 97 Alexander
 Parsons George T. clerk, bds. 29 Clinton pl.
 Parsons George W. Mrs. widow, house 29 Clinton place
 Parsons Julia A. widow, h. 28 South Ford
 Parsons Kate, dressmaker, 98 State, boards 198 North St. Paul
 Parsons Mary E. Mrs. boards 6 Cypress
 Parsons Mary M. Mrs. h. 14 Franklin square
 Parsons Theron E. bookkeeper, 122 South St. Paul, bds. 29 Clinton place
 Parsons Thomas Mrs. house 97 Alexander
 Parsons William O. student, 112 Powers' bldgs. boards 3 University avenue
 Parsonsons George T. conductor, N. Y. C. R. R. boards 183 Alexander
 Parsons Phebe, widow, h. 183 Alexander
 Partridge William H. laborer, house 236 E. Main
 Pascalar Fridoline, pastor St. Michael's church, h. 290 N. Clinton
 Pasch August, carpenter, b. 80 St. Joseph
 Pasch August W. tailor, 28 McDonald av. house do.
 Pasch Chas. laborer, house 110 Chatham
 Pasch Chas. W. laborer, house 6 Baden
 Pasch Herman F. laborer, house 23 Henry
 Pasch John F. (*Young & Pasch*), h. 55 Kelly
 Pasch John H. laborer, b. 28 McDonald av.
 Pasch Maria Mrs. boards 80 St. Joseph
 Pasch Michael, boards 55 Kelly
 Pasco Susie Mrs. bds. 232 Brown [avenue
 Passamensky Louis, peddler, h. 5 McDonald
 Patchen Eliza, widow, h. 94 Pinnacle av.
 Patchen Girard, carpenter, house 53 Pearl

Patchen Imogene, tailor^{ess}, bds. 94 Pinnacle avenue
 Patchin James M. carpenter, h. 42 Broadway
 Patten Elias, boards 62 Chestnut
 Patten James, foreman, Citizens' Gas Co. Vincent pl. n. N. St. Paul, h. Kelsey flats
 Patterson Belle E. stitcher, bds. 83 Troup
 Patterson Catharine, domestic, 42 Lorimer
 Patterson Charles H. engineer, b. 28 Ambrose
 Patterson Edgar, cutter, 24 State, house 256 North St. Paul
 Patterson Elias C. inventor, bds. 19 Atkinson
 Patterson Ella M. teacher, Hudson School, No. 16, bds. 25 Jones avenue
 Patterson George A. stove mounter, 187 W. Main, house 23 S. Ford
 Patterson John, laborer, house 50 Litchfield
 Patterson Lorenzo D. house 40 Edinburgh
 Patterson Margaret, widow, h. 69 Manhattan
 Patterson Margaret J. forewoman, boards 46 Romeyn
 Patterson Mary, widow, h. 25 Jones avenue
 Patterson Mary J. widow, boards 17 Olean
 Patterson Rebecca, b. East av. c. Alexander
 Patterson Richard, laborer, house 25 Favor
 Patterson Richard jr. piano mover, house 54 Spring [house do.
 Patterson Robert, carpenter, 4 N. Frances,
 Patterson Rufus J. foreman, 24 State, house 29 Stillson
 Patterson Sophia, widow, bds. 28 Ambrose
 Patterson Theresa O. machine operator, bds. 25 Jones avenue [Hotel
 Patterson Thomas J. real estate, b. National
 Patterson Wm. fireman, Vacuum Oil Works
 Patterson Wm. polisher, 122 Mill, bds. Brisbane near White alley
 Patterson Wm. H. agent, b. 1 Stettheimer pk.
 Pattison Charles, boatman, h. 120 Bartlett
 Pattison Wm. J. boatman, h. 120 Bartlett
 Patton Agnes, domestic, 105 Lake avenue
 Patton Charles E. shoemaker, 16 N. Clinton
 Patton George, pastor Third Presbyterian church, house 27 Prince
 Paton James, fireman, Citizens' Gas Works, house rear N. St. Paul, n. Genesee flats
 Pauckner Leonard C. clerk, boards 123 Mt. Hope avenue
 Pauckner J. Leonard, grocer, 123 Mt. Hope avenue, house do.
 Pauckner William, salesman, 76 E. Main, b. 123 Mt. Hope avenue
 Paul Anthony, carpenter, house 219 Jay
 Paul Catharine, widow, h. Jay near Ames
 Paul Christian, market, 76 Jay, house do.
 Paul Elizabeth, widow, boards 52 Spring
 Paul George, deceased July 20, 1875
 Paul Gustave, butcher, b. 115 Mt. Hope av.
 Paul Henry C. machinist, 43 State, house 84 Tappan
 Paul Nicholas, carpenter, b. Jay near Ames
 Paulus Jacob, gasfitter, 8 South St. Paul, h. 114 Pinnacle avenue [114 Pinnacle av.
 Paulus John, optician, 175 N. St. Paul, bds.
 Pausch Jacob, saloon, 66 W. Maple, h. do.
 Pausch John, carpenter, house 116 Wilder
 Paviour William, carpenter, h. 39 North av.
 Paviour William P. boards 39 North avenue

Pawsey John, laborer, 122 S. St. Paul, house 154 Lewis
 Payne Charles G. mason, house 25 Frances
 Payne Frank, hackman, 15 Fitzhugh, h. do.
 Payne Ferdinand R. shoemaker, 111 State, b. 25 Frances [St. Paul, b. 28 Gorham
 Payne George, woodworker, River n. North
 Payne James, laborer, 106 S. St. Paul, bds. 87 do.
PAYNE JAMES, picture frame mouldings, River n. N. St. Paul, house 29 Hand.—
See page 624 [Market
 Payne John B. bookbinder, 55 State, bds. 18
 Payne Phebe, teacher, boards 17 Meigs
 Payne Seth, laborer, house 93 S. St. Paul
 Payne, see Paine
 Payton William, grinder, house 99 Saxton
 Peachey Charles, grocer, 276 State, h. 7 Lyell
 Peacock Oscar H. city surveyor, City Hall, house 13 Hays
 Peacock Stephen, carpenter, house 185 Lyell
 Peake Ella Mrs. b. Frost av. opp. c. Olean
 Pearce Josephine, nurse, b. 4 Phelps avenue
 Pearce Josiah, printer, 3 West Main, house 5 Lorimer [Hall, b. 3 Trowbridge
 Pearce Louis H. hairdresser, 1 Corinthian
 Pearce Mary Ann, widow, h. 1 Fulton av.
 Pearce Rosa, stitcher, bds. 1 Fulton avenue
 Pearce Thomas, gas worker, b. 37 N. St. Paul
 Pearce William J. printer, 82 W. Main, bds. 5 Lorimer
 Pearse George P. removed to Albion
 Pearson Harry M. foreman, 215 State, boards 11 Jay [201 do.
 Pearson Thomas, sawmaker, 153 State, bds.
 Pearson William, sawmaker, 153 State, bds. 7 Vought
 Peart Charles W. butcher, house 37½ Cady
 Peart James (*Peart & Boorman*), h. 1 Tremont
 Peart Joseph B. butcher, h. Olean n. Hunter
 Peart Richard, butcher, house 40 Glasgow
 Peart Thomas, market, 132 Plymouth av. house 20 Greig
 Peart William H. butcher, house 9 Cady
PEART & BOORMAN (*J. Peart and F. F. Boorman*), market, 64 West avenue.—
See page 554
 Pease Dwight, gate keeper, House of Refuge, house 11 Bloss n. Backus avenue
 Pease Emery T. agent, boards 55 William
 Pease Emily B. boards 12 Jones avenue
 Pease Gideon C. agent, house 131 Adams
 Pease Henry, currier, house 74 Atkinson
 Pease John H. shoemaker, b. 74 Atkinson
 Pease Mary A. widow, house 55 William
 Pease Phebe, domestic, Osburn House
 Pease Seth M. clerk, 93 State, h. 71 S. Union
 Pease S. Wilder, removed to Santa Monica, California [b. 74 Andrews
 Pease William E. trunkmaker, foot Rowe,
 Peavey George, fireman, N. Y. C. R. R. b. 13 Jones
 Peck Agnes M. stitcher, boards 8 Cypress
 Peck Agnes W. widow, house 8 Cypress
 Peck Ann, widow, house 42 Martin
 Peck Edward W. sec'y and treas. Co-operative Iron Foundry, 8 Hill, h. Atkinson c. Greenwood avenue

Peck Elizabeth R. H. widow, h. 43 Adams
 Peck George, deceased February, 1876
 Peck George P. traveling agent, boards 217 Exchange
 Peck Harriet, widow, house 32 S. Clinton
 Peck Hiram M. turner, 111½ N. Water, b. 42 Martin
 Peck Horatio N. lumber dealer, h. 252 N. St. Paul [oster, b. 252 N. St Paul
 Peck H. Nelson, student, University of Rochester
 Peck Isabella, gilder, boards 42 Martin
 Peck Martha M. stitcher, bds. 8 Cypress
 Peck Sarah O. teacher, bds. 32 S. Clinton
 Peck William F. clerk, Post Office, house Greenwood avenue cor. Atkinson
 Peck William F. tailor, h. 95 Atkinson
 Peddle John, laborer, b. Mt. Hope av. opp. nursery
 Peek Ernest M. mason, h. 213 Pinnacle av.
 Peek Fernando E. house 42 Troup
 Peel Anna, housekeeper, 28 Andrews
 Peeling George, painter, 207 E. Main, house Culver n. Webster road
 Peeling John, gardener, h. Culver n. Webster road
 Peer Benjamin, carpenter, house 126 Scio
 Peer Egbert, expressman, 83 State, house 58 Baden
 Peer George E. clerk, boards 23 N. Clinton
 Peer Geo. W. physician, 23 N. Clinton, h. do.
 Peer John, clerk, 194 State, bds. 22 Ontario
 Peer Mary, widow, house 22 Ontario
 Peer Stanley A. removed to Buffalo
 Peet Ezra M. agent, house 23½ Reynolds
 Peet Herbert F. removed to Brockport
 Peet James C. student, University of Rochester, boards 20 Park avenue [3 Poplar
 Peet James D. trunkmaker, Aqueduct, house
 Peet Joshua G. hostler, Park Hotel, Rochester Driving Park, bds. do.
 Peet, see Peth
 Peeters Mary A. fancy goods, 1 Grand, h. do.
 Peeters Wm. J. chairmaker, 117 N. Water, boards 1 Grand
 Peets William P. carpenter, b. Lewis near Meigs [Clifford n. Hudson
 Pehl Charles, wagon maker, 55 Fitzhugh, h.
 Pehrsson Anders, framemaker, 118 Front, h. 13 Favor [Clifford c. Maria
 Peiffer Joseph, foreman, 106 S. St. Paul, h.
 Peitshon Ernst, laborer, h. 44 Sellsinger
 Peitshon John, laborer, house 44 Sellsinger
 Pell John, shoemaker, 30 Franklin, house 81 Orange [13 Jones
 Pellens Wm. engineer, N. Y. C. R. R. boards
 Pellett Frank, coachman, h. Sibley n. Bates
 Pelling William H. carrier, Post Office, h. 47 Pearl
 Pells Abram V. (*Goodale & Pells*), 65 West Main, house East avenue n. Goodman
 Pelmont Leopold, saloon, boards 7 North av.
 Pelton M. L. widow, house 13 Stillson
 Pemberton Thomas, fireman, N. Y. C. R. R. house 8 Helena
 Pendegrast Michael, laborer, h. 16 Costar
 Pendelbury Ralph, driver, 61 Front, house 124 Caledonia avenue
 Pender Thomas, laborer, house 84 Broadway

Penney John H. teamster, bds. 143 North av.
 Penney Rebecca L. widow, h. 143 North av.
 Pennington Wm. M. carpenter, house 53
 Cypress
 Penny Azel G. books, &c. 272 State, h. do
 Penny Benjamin F. millinery, 111 E. Main,
 house 89 Fulton avenue
 Penny Daniel, machinist, house r. 16 Frank
PENNY E. A. millinery, 111 E. Main, h.
 89 Fulton av.—*See page 547*
 Penny Frank A. painter, house 35 Thompson
 Penny George S. carriage trimmer, bds. 89
 Fulton avenue [39 Cherry
 Penny Sanford A. machinist, 153 State, bds.
 Penny Wilbur D. miller, h. rear 89 Fulton
 avenue
 Pentecost James R. deceased March, 1876
 Pentecost Jane, widow, house 56 Court
 Pentecost John R. & Co. (*E. Ocumpaugh*),
 millers, 1 W. Main, house 14 Park av.
 Penzlien Frederick J. C. laborer, h. Clifford
 near North Clinton [Lyell
 Peoples George N. clerk, 186 State, bds. 22
 Peoples James S. furnaceman, 187 W. Main,
 house 22 Lyell [State, b. 22 Lyell
 Peoples John L. gents' furnishing goods, 178
 Peoples Mary M. clerk, boards 22 Lyell
 Peper August, show case maker, Exchange
 cor. Court, boards 15 Bond
 Peper Charles, laborer, h. Caroline n. Meigs
 Peper Christina, widow, boards 15 Bond
 Peper Frederick, laborer, h. Lewis n. Meigs
 Peper Hannah, widow, boards 144 Lewis
 Peper William, carpenter, house 15 Bond
 Pepper John, boards 5 Caroline
PERCY GEORGE W. grocer, 40 Allen, h.
 69 do.—*See page 557*
 Percy John G. clerk, 83 Exchange, house 36
 Catharine
 Percy Thomas, house 162 North Clinton
 Percy William T. fireman, b. 162 N. Clinton
 Perham John, painter, house 7 W. Maple
 Perhamus James H. teamster, h. 68 Platt
 Perhamus Mary Mrs. dressmaker, 68 Platt,
 house do.
 Perin Louis, deceased, May, 1875
 Perin Wilhelmina, widow, house 41 Hoeltzer
 Perina Ignatz, cigarmaker, 48 Exchange, b.
 Reed House
 Perkins A Erickson, ass't teller, 25 State, b.
 12 South Washington
 Perkins Charles, house 95 Court
 Perkins Emma, teacher, Munger School, No.
 13, boards 8 Chestnut [48 Spring
 Perkins George H. clerk, 16 Exchange, bds.
 Perkins Gilman H. (*Smith, Perkins & Co.*),
 16 Exchange, house 12 S. Washington
 Perkins Jacob D. watchman, house avenue B
 Perkins James B. (*Cogswell & Perkins*), 18
 Powers' bldgs. boards Osburn House
 Perkins Jenckes W. agent, 8 State, boards
 33 Adams
 Perkins Jewett J. removed from city
 Perkins Joseph H. musician, house 26 Hunter
 Perkins Lucia F. teacher, Riley School, No.
 14, boards 8 Chestnut
 Perkins Mary A. nurse, bds. 19 Jones avenue
 Perkins W. H. Mrs. widow, house 48 Spring

Perlin Carl, laborer, house 155 N. Clinton
 Pernet F. W. waiter, Osburn House
 Pero Edward, teamster, h. Briggs pl. n. York
 Pero James, painter, boards 13 Mortimer
 Perriard Joseph, machinist, house 31 Scio
 Perrin Abraham, cabinetmaker, 198 North
 Clinton, house do.
 Perrin Bros. (*E. W. Perrin and F. Perrin*),
 furniture manufs. Rowe n. Lake avenue
 Perrin Charles H. cabinetmaker, Rowe near
 Lake avenue, boards 209 N. St. Paul
 Perrin Darius, 27 Arcade, h. 31 N. St. Paul
 Perrin David, maltster, boards 2 Smith
 Perrin Edwin W. (*Perrin Bros.*), Rowe near
 Lake avenue, house 209 N. St. Paul
 Perrin E. M. boards Farmers' Hotel
 Perrin Frank, mason, house 13 Munger
 Perrin Frederick (*Perrin Bros.*), Rowe near
 Lake avenue, house 211 N. St. Paul
 Perrin Jacob, clerk, 11 West Main, house 62
 Pinnacle avenue
 Perrin Lewis B. contractor, h. 30 N. Union
 Perrin Lyman, mason, house 88 Scio
 Perrin Robert, maltster, boards 2 Smith
 Perrine Robert, 29 Mumford, house 12 Kent
 Perry Chauncey, lawyer, 48 Arcade, house 13
 Broadway
 Perry David, laborer, boards 88 Atkinson
 Perry Eleanor, widow, boards 163 N. Clinton
 Perry Frank B. teamster, boards 9 Jay
 Perry Fred. C. removed from city
 Perry Harvey, salesman, 40 State, house 12
 West Troup [Delevan
 Perry Henry E. painter, 14 Stone, house 36
 Perry Horace P. A. house 24 Jones
 Perry Hugh, carpenter, Brown c. Jones, h.
 24 Kent
 Perry Joseph A. pressman, h. 88 Atkinson
 Perry J. Ralph, shoe cutter, Andrews corner
 N. Water, boards 24 Jones
 Perry Luther B. engineer, 13 Warehouse, h.
 26 Centre
 Perry Moses W. teamster, house 9 Jay
 Perry Rosanna, widow, house 195 Scio
 Perry Walter J. overseer, House of Refuge,
 boards do.
 Perry William, engineer, bds. 163 N. Clinton
 Persons Luceine I. (*Tuttle & Persons*), boards
 9 Elm [Clinton
 Peschelke Henry, laborer, boards 257 North
 Peschrosky Simon, peddler, house 7 Herman
 Peshine Thomas P. clerk, 21 West Main, bds.
 31 Greig
 Peter Andrew, laborer, h. North av. n. Bay
 Peter Anthony, turner, 135 N. Water, boards
 84 North Frances [Frances
 Peter George, cabinet maker, 2 Hill, bds. 84
 Peter John, house 30 Hebard
 Peter John G. cooper, Magne n. Lyell, house
 144 Jay [144 Jay
 Peter John J. jr. cooper, Magne n. Lyell, bds.
 Peter Peter, flour and feed, 116 Pinnacle av.
 house 1 Whalin [10 Tyler
 Peter Reinold, fireman, N. Y. C. R. R. bds.
 Peter Vincent, laborer, 8 Hill, h. 84 Frances
 Peters Adolph, porter, 53 East Main, house
 21 Munger
 Peters Aloys J. clerk, boards 21 Munger

Peters Anna, widow, house 73 Pinnacle av.
 Peters Anna C. tailoress, h. Goodman n. Bay
 Peters August, fireman, boards 1 Tyler
 Peters Carolina, widow, boards 9 Catharine
 Peters Christian, laborer, house 38 Sellinger
 Peters Christian, groom, house 13 Hoeltzer
 Peters Christian jr. laborer, bds. 38 Sellinger
 Peters Claus, student, Rochester Theological
 Seminary, boards 118 Alexander
 Peters David, painter, house 2 Fullam's pk.
 Peters Didlove, rag peddler, h. 24 Ontario
 Peters Frank, laborer, house 85 Wilder
 Peters Fritz, laborer house 187 Scio
 Peters George, removed from city
 Peters Helena, widow, boards 34 Vienna
 Peters Henry B. nurseryman, house avenue
 D near N. St. Paul
 Peters Henry P. collarmaker, 77 State, bds. 1
 Grand
 Peters Horatio, house 62 South St. Paul
 Peters John, mason, house 35 Huntington
 Peters Joseph F. salesman, 18 West Main, b. 21
 Munger
 Peters Julia, dressmaker, boards 10 Oregon
 Peters Mary Ann, teacher, Holy Family
 School, Jay cor. Ames, boards 265 Jay
 Peters Matthew, hack driver, at N. Y. C. R. R.
 depot [house 26 Pearl
 Peters Matthias S. door manuf. 3 Aqueduct,
 Peters Reece, house 62 South St. Paul
 Peters Samuel K. student, 71 Powers' bldgs.
 boards 11 Selden [11 Hudson
 Peters Wm. A. bookkeeper, 73 N. Water, bds.
 Peters William A. bookkeeper, 18 W. Main,
 house 27 Cherry
 Peters William R. (D. W. Wright & Co.), 73
 North Water, house 26 Pearl
 Peters, see Peeters [185 N. Clinton
 Petersen Adolph, teacher, 7 Mortimer, house
 Petersen Lucy, teacher, 7 Mortimer, house
 185 North Clinton
 Peterson August, mason, h. 11 Irondequoit
 Peterson Mark, laborer, 38 Fitzhugh, boards
 52½ Spring
 Peterson Parson H. salesman, house 26 Gar-
 diner park
 Peth Frederick, laborer, house 7 Pryor
 Petsch Caroline, widow, b. Barth n. Vienna
 Petschow Henry, laborer, h. 32 Buchan park
 Pettengill James O. 13 Powers' bldgs. house
 11 Atkinson
 Petter Damian, laborer, house 17 Lowell
 Pettinger David, carpenter, 3 Aqueduct, h.
 9 Lewis
 Pettinger Elizabeth Miss, h. 3 Chestnut park
 Pettinger William, carpenter, 3 Aqueduct, b.
 9 Lewis [Myrtle
 Pettis William A. carpenter, house Lyell cor.
 Pettit Calvin D. painter, house Goodman n.
 Monroe avenue
 Pettit Frederick J. removed to California
 Petzoldt William, clerk, 4 W. Main, house
 King corner Brown
 Peuss Ernst, mason, house 104 Hudson
 Peuss Frederick, laborer, h. 15 Buchan park
 Peuss Julius C. tailor, 105 Hudson, boards 15
 Buchan park [Nassau
 Pew Walter, brakeman, N. Y. C. R. R. h. 48

PFAEFFLIN HERMAN, principal Real
 Schule, 7 Mortimer, h. do.—See Schools
in contents
 Pfaff Charles, laborer, house 44 Nassau
 Pfaff Frederick W. druggist, 118 State, h.
 68 Franklin [Davis
 Pfaff George, shoemaker, 77 N. Water, h. 31
 Pfaff John, shoemaker, 212 E. Main, house
 83 Kelly [96 St. Joseph
 Pfaff Joseph, shoemaker, 91 N. Water, h.
 Pfaff Michael F. mason, house 67 Kelly
 Pfaff Valentine, blacksmith, h. 108 Chatham
 Pfahler Henry, engineer, house Culver place
 near University avenue
 Pfahler Johanna, widow, house 11 Childs
 Pfahler Willwald, laborer, h. 90 Reynolds
 Pfarrer George, market, 139 Lyell, house do.
 Pfaudler Caspar, brewer, 139 N. St. Paul,
 house 283 N. Clinton
 Pfaudler Charles, tobacconist, 25 W. Main, b.
 283 N. Clinton
 Pfaudler John, boxmaker, foot Centre, bds.
 283 N. Clinton
 Pfaudler Michael, deceased Feb. 1876
 Pfeffer Chas. (Pfeffer & Zimmer), h. 49 Orange
 Pfeffer & Zimmer (C. Pfeffer and F. Zimmer),
 market, 122 West Main [11 Childs
 Pfehler Louis N. hairdresser, 3 Mill, boards
 Pfeifer Adolph, butcher, h. Ulm near Hoyt
 Pfeifer Frances, widow, house 9 Rauber
 Pfeifer Jacob, carpenter, 14 St. Joseph, h.
 43 Lewis
 Pfeifer John, shoemaker, house 59 Weld
 Pfeifer John, butcher, house Hoyt near Ulm
 Pfeifer John C. laborer, boards 59 Weld
 Pfeifer Sarah Mrs. house 106½ West Main
 Pfeiffer Conrad, bakery, 25 Galusha, h. do.
 Pfeiffer Jacob, blacksmith, bds. 11 West av.
 Pfeiffer John, teamster, 149 Exchange, h.
 61 Sanford [N. Union
 Pfeiffer Magnus, carpenter, house Lewis n.
 Pfeiffer, see Pifer and Peiffer
 Pfenninger George, carpenter, h. 13 Wilson
 Pffiffer Anthony, boards 5 Andrews
 Pfistner Matthias, saloon, 22 South, house do.
 Pfitsch Caroline, widow, house 28 Tyler
 Pfitsch Henry, carpenter, house 42 Kelly
 Pfitsch Valentine, carpenter, bds. 42 Kelly
 Pfluger Charles, carpenter, house 63 Davis
 Pflugy Carrie, dressmaker, bds. McCracken
 corner Thorn
 Pflugy Joseph, turner, h. McCracken c. Thorn
 Pflum Henry, laborer, Exchange opp. Troup,
 house 143 Saxton
 Pflum Joseph, teamster, Exchange n. Troup,
 house Champion c. Fulton av. [bell
 Pfpoff John, laborer, 116 Mill, h. 105 Camp-
 Pfrom John, laborer, boards 102 Mill
 Pfrommer Gottlieb, laborer, house 2 Thomas
 Pfrommer John, brakeman, h. 27 Gregory
 Pfrommer Martin, laborer, house Alphonse
 near Hudson
 Pfuhl Ferdinand, sawfiler, 38 Catharine, h. do.
 Pheil George, hostler, 108 N. Clinton, b. do.
 Phelan Cecilia, widow, house 3 Amity
 Phelan Celia, widow, house 27 Lancaster
 Phelan James H. boots and shoes, 2 Mum-
 ford, h. 59 Atkinson

Phelan Jeremiah (*Phelan & Bolton*), Andrews c. N. Water, h. 10 Franklin sq.
 Phelan John, peddler, house 36 Rhine
 Phelan Mary Mrs. house 65 Broadway
 Phelan Mary A. 76 State, house Troup corner Washington [Troup c. Washington
 Phelan Michael C. millinery, 76 State, house
PHELAN & BOLTON (*J. Phelan and T. Bolton*), shoe manufacturers, Andrews c. N. Water.—*See page 664*
 Phelon James M. & Co. (*E. P. Hart*), extinguishers, 55 W. Main, h. at Cherry Valley
 Phelps Anna M. Mrs. boarding house, 228 N. Clinton, house do.
PHELPS EDWARD S. & CO. (*N. B. Phelps*), fire arms, sporting apparatus and clothes wringers, 4 E. Main, house do.—*See page 618*
 Phelps Emma A. dressmaker, b. 8 Shamrock
 Phelps George W. frame manuf. 38 Gorham, h. 8 Shamrock [bldgs. h. 100 Hudson
 Phelps Helen E. music teacher, 179 Powers'
 Phelps Henry, deceased March, 1876
 Phelps John A. clerk, 178 State
 Phelps John H. agent, house 111 East Main
 Phelps Judson L. frame maker, 38 Gorham, house 8 Shamrock
 Phelps Julia, widow, house 100 Hudson
 Phelps Lucius R. salesman, b. 44 Alexander
 Phelps Matthew H. machinist, b. 34 North av.
 Phelps Myron A. removed to Buffalo
 Phelps Newman S. salesman, 55 S. St. Paul, house 12 Marshall [h. at New York
 Phelps Napoleon B. (*E. S. Phelps & Co.*),
 Phelps Roswell, house 44 Alexander
 Phelps Sarah J. widow, boards 8 Shamrock
 Pheneuf Louisa Miss, bds. 182 Pinnacle av.
 Pheteplace Daniel S. machinist, Court cor. Stone, house 55 Court
 Phifer Joseph, tailor, boards 12 Pitt
 Phifer Charles R. shoemaker, 73 N. Water, boards 43 Sibley's block
 Phillips Cyrus D. (*Daniels & Phillips*), 16 W. Main, boards 19 Edinburgh
PHILLIPS C. A. & CO. (*E. A. Phillips*), coal dealers, 1 Arcade, West Main st. swing bridge, Smith n. R. R. and 117 S. St. Paul, house 19 West av.—*See inside back cover*
 Phillips David E. house 31 North avenue
 Phillips Edward A. (*C. A. Phillips & Co.*), house 1 Centre park
 Phillips Edwin, laborer, house 20 Warehouse
 Phillips Elizabeth A. widow, b. 15 Glasgow
 Phillips Elizabeth B. widow, h. 23 Phelps av.
 Phillips Ellen A. teacher, Riley School, No. 14, boards 7 George
 Phillips Ellery P. coffin trimmer, 87 Exchange, house 21 Stewart
 Phillips Emily Miss, boards 96 Pearl
 Phillips Galusha, auction rooms, 26 E. Main, house 12 Caledonia avenue
 Phillips George F. machinist, Brown cor. Jones, house 11 Oak [Monroe av.
 Phillips George W. (*Phillips & Neer*), h. 15½
 Phillips Harry C. clerk, 62 State, house 29 South avenue
 Phillips James W. agent, 3 Canal

Phillips John, laborer, house 39 Brown block
 Phillips John F. engineer, Court cor. Stone, house 157 Hunter
 Phillips John W. bookkeeper, Smith n. R. R. house 9 North Washington [Oregon
 Phillips Levi H. (*Phillips & Fuller*), h. 19
 Phillips Louis, blacksmith, Brown c. Jones, house 96 Kelly [Clinton Hotel
 Phillips Miller B. salesman, 53 E. Main, b.
 Phillips Oliver, laborer, house rear 26 Smith
 Phillips Philip S. peddler, 144 E. Main, h. 37 Sibley's block
 Phillips Ruth, widow, house 19 Edinburgh
 Phillips Solomon G. salesman, 7 West Main, h. 7 George [Roch. b. 81 Sibley's blk.
 Phillips Thomas, student, University of
 Phillips Thomas, foreman, 55 Mill, h. 43 Walnut [North Washington
 Phillips William, trimmer, 87 Exchange, b. 9
 Phillips William, wireworker, 79 State, h. do.
 Phillips & Fuller (*L. H. Phillips and D. P. Fuller*), liquors, 1 North
 Phillips & Neer (*G. W. Phillips and W. E. Neer*), frog pads, 16 Stone
 Philp William, blacksmith, 115 S. St. Paul, house 2 Hickory
 Phinney Frank D. student, University of Rochester, b. 4 Brighton avenue
 Phinney Herman K. student, University of Rochester, boards 4 Brighton avenue
 Phinney Smith H. pattern maker, 187 West Main, house 4 Brighton avenue
 Picard Isaac, drover, house 55 St. Joseph
 Pick Bernard, pastor, German United Evangelical Trinity Church, house 20 Allen
 Pickard Augustin, boards 57 Lyell
 Pickard Daniel L. h. 73 Pinnacle avenue
 Pickard Daniel L. boxmaker, 57 State, bds. 89 Tappan
 Pickett Charlotte, widow, boards 14 William
 Pickett Tirzah A. house 11 Reynolds
 Pickett William, mason, boards 9 Stone
 Pickettock Sophia, widow, h. 42 S. Union
 Pickup Elizabeth, widow, b. 8 Alexander
 Picot Nathan, cooper, 50 Lowell, house do.
 Picot Sarah J. tailoress, boards 50 Lowell
 Pidrick William, carpenter, 20 Smith, h. do.
 Pidrick William H. carpenter, b. 20 Smith
 Piehler Anthony, printer, 18 N. St. Paul, b. 162 Wilder [Wilder
 Piehler Fred. printer, 18 N. St. Paul, b. 162
 Piehler John, tanner, 87 North Water
 Piehler Sebastian, butcher, h. 162 Wilder
 Pier William, waiter, Clinton Hotel, b. do.
 Pierce Abby J. Mrs. widow, h. 106 Hunter
 Pierce Caleb, policeman, N. Y. C. R. R. depot, house 16 Sophia [lum, b. do.
 Pierce Carrie E. teacher, Roch. Orphan Asy-
 Pierce Chas. H. bartender, 92 E. Main, boards 88 do.
 Pierce Delclutha, teacher, Wadsworth School, No. 12, boards 1 Pearl
 Pierce Delos, house 29 Adams [Main
 Pierce E. Joseph, photographer, b. 146½ W.
 Pierce Francis E. machinist, h. 19 Broadway
 Pierce Frank B. shoemaker, 91 N. Water, b. York House [boards 86 do.
 Pierce Frank W. sign painter, 146 E. Main,

Pierce Geo. L. stove mounter, b. 106 Hunter
 Pierce Henry L. switchman, b. 3 Kent alley
 Pierce Horace G. student, 90 W. Main, h. 129 Caledonia avenue
 Pierce Isaac C. farmer, house 26 Greig
 Pierce James B. clerk, 31 East Main, house 15 Joslyn park [16 Sophia
 Pierce James H. pressman, 82 W. Main, b.
 Pierce Jennie, servant, Whitcomb House
 Pierce Joseph W. saloon, 146 East Main, h. 86 do. [Lockport
 Pierce J. S. salesman, 147 State, house at
 Pierce Martha A. boards 5 Selden
 Pierce Mary A. teacher, Seward School, No. 19, house 20 Cottage
 Pierce Mary J. widow, house 3 Kent alley
 Pierce Mary J. widow, house 28 Stone
PIERCE NATHANIEL A. real estate, 41 Arcade, house 75 Scio.—*See page 508*
 Pierce Robert C. house 1 Pearl
 Pierce Samuel C. principal, Genesee School, No. 4, boards 26 Greig [Broadway
 Pierce Sanford D. truckman, boards 19
 Pierce Sarah E. tailorress, boards 29½ Munger
 Pierce Sidney A. physician, 24 E. Main, h. do.
 Pierce Susan M. widow, b. 15 Joslyn park
 Pierce William, liquors, 92 E. Main, h. 88 do.
 Pierce William H. boatbuilder, h. 54 Pearl
 Pierce, see Pearse and Pearce
PIERPONT JONATHAN E. secretary and treasurer, Monroe Co. Savings Bank, 31 State, h. 26 North av.—*See page 497*
 Pierpont Ogden E. salesman, 17 State, b. 340 State
 Pierpont Thomas, paper hanger, 14 Stone, house Bartlett near Frances [Vought
 Pierson William, sawmaker, 153 State, b. 7
 Pietrucken Jacob, mason, h. 295 St. Joseph
 Pifer Ella Miss, boards 16 South Clinton
 Pifer Frank J. shoemaker, 15 Mill, boards 99 Tremont
 Pifer George A. shoemaker, b. 99 Tremont
 Pifer John H. whipmaker, Allen n. North Washington, boards 504 Brown
 Pifer Mary, widow, house 99 Tremont
 Pifer Peter, cartman, house 45 Davis
 Pifer, see Peiffer and Pfeifer
 Pigorsch Albert, laborer, house 19 Maria
 Pike Andrew S. milkman, house 21 Spencer
 Pike Almira, nurse, house 36 Charlotte
 Pike John D. machinist, 10 S. Water, h. 23 Goodman [Conkey avenue
 Pike Herman, carpenter, Minerva alley, h. r.
 Pike H. John, moulder, 20 Court, h. Hudson near Berlin
 Pike James B. (*Bates & Pike*), 92 Powers' bldgs. house 100 Genesee
 Pike Jane, widow, boards 23 Goodman
PIKE JOHN B. carpenter and contractor, Minerva place, house 51 Goodman.—*See page 591*
 Pike Wm. C. farmer, boards 21 Spencer
 Pike Wm. S. engineer, N. Y. C. R. R. h. 38 North avenue [Paul
 Pillow Wm. H. fruit grower, h. 259 N. St.
 Pillsbury Lewis P. boards 5 Howell
 Pimm Catharine, widow, b. Monroe av. c. S. Union

Pinchbeck William, saloon, 15 Monroe av. house do.
 Pincow Henrietta Mrs. millinery, 107 E. Main, house 35 Clinton place
 Pindar Anna, dressmaker, boards 66 Scio
 Pinket Lear A. widow, boards 16 S. Ford
 Pinkham Addie T. teacher music, house 163 Alexander [Paul, h. 163 Alexander
 Pinkham Charles E. physician, 22 North St.
 Piotter Frank, tailor, 71 Joiner, b. 25 McDonald avenue [Conkey av.
 Piotruschke Fred. laborer, h. avenue C near
 Piper Augustus M. teamster, 31 Exchange, b. 144 Lewis
 Piper John, nurse, house 8 Vine
 Pippart Frederick, blacksmith, h. 58 Gregory
 Pistorious Frederick, piano tuner, 82 State, house 68 Caledonia avenue
 Pitcher Hiram D. agent, boards 1 South
 Pitcher John G. removed to Irondequoit
 Pitcher Joseph, foreman, house 12 Erie
 Pitkin James M. & Co. (*C. H. Matthews*), grocers, 75 East av. house 33 Charlotte
 Pitkin John P. 22 West avenue, boards 27 West avenue
PITKIN PETER, stone and monumental works, 22 West avenue, house 27 do.—*See page 660*
 Pitkin Sarah B. Miss, boards 46 Troup
 Pitkin Wm. bookkeeper, 7. W. Main, b. 33 Charlotte
 Pitkin Wm. Mrs. house 46 Troup
 Pitts Rulandus, saloon, 2 West av. house 7 Trowbridge
 Pius Sister, teacher, boards Jay cor. Frank
 Pixley Roxanna G. widow, house 15 Asylum
 Place Frank F. photographer, b. 24 Tappan
 Place Freeman, carpenter, house 24 Tappan
 Placida Mary, Sister, Notre Dame, Hudson corner Clifford
 Plahn Frederick, laborer, house 41 Herman
 Plakempole Lena, tailorress, boards 70 Clifton
 Plant Henry M. clerk, Goodman st. telegraph office, boards 15 East
 Plant Julius, hairdresser, boards 59½ Baden
 Plant Napoleon, boot crimper, h. 60 Baden
 Plant Wm. H. track master, North st. R. R. office, house 15 East
 Plass Elizabeth, widow, house 22 Oregon
 Plass Peter R. clerk, 10 State, b. 22 Oregon
 Plassie Jennie, clerk, 98 North av. boards 22 Oregon [154 West avenue
 Platt Daniel B. salesman, 147 State, boards
 Platt Joseph, grocer, 109 Genesee, h. 40 York
 Playter Thomas, newsroom, 317 State, h. do.
 Playter Ely, teamster, 47 S. St. Paul, house • rear 14 Market
 Pleau Francis, kitchen man, house 8 Stone
 Pleau George, shoemaker, house 1 Huron
 Plemon Thomas, dep. warden, Monroe Co. Insane Asylum, boards do.
 Plow Frank, yardman, National Hotel, h. 8 Stone [Greig
 Plummer Charles H. clerk, 6 State, boards 19
 Plummer Franklin R. bookkeeper, 8 State, h. 32 Frances [19 Greig
 Plummer John E. printer, 1 Aqueduct, bds.
 Plummer Maria, widow, house 19 Greig

Plummer Raymond, sailmaker, 42 Exchange, house Exchange cor. Ritter
 Plummer Wm. A. salesman, 39 State, house Rowley near Park avenue
 Plunkett Alice, domestic, 49 Ambrose
 Plunkett James, drayman, house 104 Adams
 Plunkett Kate, stitcher, boards 13 West
 Plunkett Mary, widow, house 13 West
 Plunkett Patrick, cartman, boards 13 West
 Plunkett Thomas, tinsmith, boards 13 West
 Plunkett Thomas, hostler, Lake av. n. Little Ridge road, boards do. [West av.
 Poensgen Anthony, foreman, 22 West av. h. 92
 Poinan Edward, driver, 53 E. Main, h. Upton park near East avenue
 Pointer Edward, laborer, h. 26 Conkey av.
 Poise Charles, laborer, house Uln n. Hoyt
 Poissant Napoleon, shoemaker, 75 N. Water, house 31 Lancaster [do.
 Polacco John, waiter, Whitcomb House, bds.
 Poleni Oscar, removed to Detroit
 Pollard Frank, laborer, b. Lake View near toll gate
 Pollard Frank, shoemaker, h. 71 Charlotte
 Pollard Emma, boards 15 Jay
 Pollard John C. machinist, boards 15 Jay
 Polley Alexander H. printer, 23 West Main, boards 10 James [St. Paul
 Polley Deloss L. (*Polley & Croft*), h. 270 North
 Polley George W. house 10 James
 Polley James, removed from city
 Polley Marion B. clerk, boards 51 Asylum
POLLEY & CROFT (*D. L. Polley and H. W. Croft*), coal, 3 North Clinton.—See page 599 [45 Fitzhugh
 Pollock James B. (*Pollock, Weaver & Co.*), h.
POLLOCK, WEAVER & CO. (*J. B. Pollock, C. F. and R. M. Weaver and J. W. Goss*), hardware and cutlery, 17 W. Main.—See page 631
 Pomeroy Alexander, house 119 Lake avenue
 Pomeroy Carter P. student, University of Rochester, boards 37 Meigs n. Park av.
 Pomeroy Charles, painter, b. 162 N. St. Paul
 Pomeroy Charles H. tobacconist, 25 E. Main, house 13 Chatham
 Pomeroy Howard N. student, University of Rochester, bds. 37 Meigs near Park av.
 Pomeroy Ira, boards 119 Lake avenue
 Pomeroy John N. lawyer, house 37 Meigs
 Pomeroy Rhea B. student, 116 Powers' bldgs. boards 22 Frank
 Pomeroy Simeon, agent, h. 162 N. St. Paul
 Pomeroy Simeon B. machinist, 69 State, b. 162 North St. Paul
 Pommrein Theodore, laborer, 38 Gorham, h. Hollister corner Clifford
 Pond Charles F. (*Wilsons & Pond*), South Water, boards 65 Plymouth avenue
 Pond Edward, clerk, Post Office, boards 63 North St. Paul
 Pond Elbert, deceased November, 1875
 Pond Elbert Mrs. dressmaker, 6 Jones, h. do.
 Pond Frank, civil engineer, Leighton works, house 8 Scio
 Pond J. Dickinson, removed from city
 Pond Nathan P. sec'y Rochester Printing company, 3 W. Main, h. 63 N. St. Paul

Pool Charles A. 3 Smith's block, h. 14 Oak
 Pool Herbert W. removed to Oswego
 Pool James F. tinware, 266 State, h. 280 do.
 Pool Richard, removed to Auburn
 Poole Maggie, domestic, 12 Bolivar
 Poole Robert, shoemaker, 343 State, house 16 Smith
 Poole William R. removed to Buffalo
 Pope Alexander J. clerk, 50 Front, boards York House [Fitzhugh
 Pope Edgar B. salesman, 92 State, house 40½
 Pope E. boards 12 North Water
 Pope Frederick W. groom, 159 State, boards Alphonse n. Thomas
 Pope Henry R. groom, 159 State, house Alphonse n. Thomas [63 Charlotte
 Pope Lucy R. teacher, Free Academy, bds.
 Pope Lizzie Miss, baker, boards 117 Adams
 Pope Mary J. Miss, house 205 Exchange
 Pope Wm. 16 East avenue, b. 63 Charlotte
 Pope Wm. O. clerk, 16 East avenue, boards 63 Charlotte [76½ Frances
 Popkiss Edward, clerk, 197 E. Main, house Popp George, chairmaker, h. Fourth n. Rowe
 Popp George, laborer, house 3 Nassau
 Popp John, shoemaker, 111 State, h. Caroline cor. Meigs
 Popp John, cutter, 72 Mill, house 131 Jay
 Popp John, grocer, Meigs c. Caroline, h. do.
 Popp John, shoemaker, house 12 Hawkins
 Popp John G. (*Sackett & Popp*), 29 Arcade, house 86 Champlain [house do.
 Popp John G. shoestore, 81 Mt. Hope av.
 Popp Leonard, shoemaker, 27 Mt. Hope av. house do.
 Popp Margaret Mrs. fancy goods, 131 Jay,
 Popp Margaretta B. bds. 81 Mt. Hope av.
 Popp Mary K. widow, house 4 Morris
 Popp Michael J. framemaker, bds. 4 Morris
 Popp Otto C. grocer, 119 Jay, house do.
 Poppel Edward H. driver, 41 Sophia, b. do.
 Poppen Detmer, principal German school, Franklin n. N. Clinton, house 86 Scio
 Poppert Wm. painter, h. 123 North Union
 Poppink Bernard A. painter, 5 S. St. Paul, house 16 Vose [Edinburgh
 Poppino G. Dudley, carpenter, house 46
 Poppy Alfred, removed from city
 Poppy Anna E. widow, house 7 Lyell
 Poppy John H. (*Smith & Poppy*), 72 West avenue, house 40 Frances
 Porcella Emanuel, peddler, b. rear 47 North St. Paul
 Porrey Elizabeth S. widow, h. 49 St. Joseph
 Port Charles, mason, house 44 Herman
 Port Peter, mason, h. N. Clinton n. Clifford
 Porter Almira B. private school, h. 12 Canal
 Porter Carlton A. bookkeeper, Lake av. cor. Rowe, h. McCracken n. Lake avenue
 Porter Catharine M. widow, h. 242 Exchange
 Porter Charles E. storekeeper, house 26 N. Frances
 Porter Charles W. printer, boards 23 Vine
 Porter Crawford, clerk, 4 Front, bds. 34 S. Washington
 Porter Edward, removed to Brockport
 Porter Elizabeth, widow, bds. 54 Hanover
 Porter Elizabeth D. Miss, boards 12 Canal

HENRY C. WISNER,

**CUT AND PRESSED GLASS TABLE WARE,
 No. 33 STATE STREET.**

- Porter Henry, telegrapher, Whitcomb House, boards 242 Exchange
- Porter Isabella J. widow, house 12 Canal
- Porter Lorinda S. clerk, boards 14 Kent
- Porter Maria G. Miss, boarding house, 12 Canal
- Porter Mary Jane, widow, h. 47 Pinnacle av.
- Porter Ransford W. mason, house Morgan n. Clifton
- P**ORTER SAMUEL, barrel head manuf. Oak cor. Smith, h. 23 Elizabeth.—See page 671 [York House]
- Porter Samuel C. tinsmith, 29 Exchange, bds.
- Porter Samuel D. real estate, 27 Arcade, h. 62 Fitzhugh
- Porter Victoria, milliner, boards 14 Kent
- Porter William H. laborer, house Bismarc place near N. St. Paul [h. 59 Allen]
- Porter William S. engineer, N. Y. C. R. R.
- Porter Zaccheus B. magnetic physician, house 14 Kent [house Prospect]
- Portland Thomas, coachman, 66 Exchange,
- Posner Joseph, painter, house 100 St. Joseph
- Possee Ira, laborer, boards 2 Fullam's park
- Post Amy (J. K. Post & Co.), h. 36 Sophia
- Post Catharine, widow, house 8 Victoria
- Post Catharine, widow, h. Childs' al. n. canal
- Post Dennis T. car coupler, boards 8 Victoria
- Post Dingman, sawyer, house 44 Chatham
- Post Isaac, farmer, h. r. Chili road n. city line
- Post Jacob K. & Co. (Amy Post), druggists, 4 Exchange, house 97 Plymouth avenue
- Post James E. produce dealer, b. r. Chili road near city line
- Post Jane G. Mrs. boards 22 John
- Post John, car coupler, boards 8 Victoria
- Post Joseph, clerk, house 18 Sophia
- Post Julius A. physician, 85 E. Main, b. do.
- Post Mary, tailoress, boards 8 Victoria
- Post Mary E. Miss, b. r. Chili road n. city line
- Post Michael W. yardmaster, h. 63 Prospect
- Post Myron, grocer, Broadway cor. Alexander, boards do.
- Post Sarah, cook, 53 East avenue [Sophia]
- Post Willet E. clerk, 4 Exchange, boards 36
- Post Woodruff, clergyman, h. Clifford n. N. St. Paul
- Potter Alexander B. mason, h. 131 South av.
- Potter Allison J. clerk, 14 W. Main, boards 23 University avenue [Haag blk.]
- Potter Benjamin, hostler, 15 Fitzhugh, house
- Potter Charles B. real estate, 96 Front, house Marshall cor. Wadsworth square
- Potter Clara E. Mrs. surrogate's office, Court House, boards 58 Platt [house do.]
- Potter Clarissa, dressmaker, 153 East Main,
- Potter Geo. master builder, N. Y. C. R. R. Mill cor. Centre, house 166 State
- Potter George, stabler, h. 23 University av.
- Potter Henry S. 2 Mumford, h. 96 Fitzhugh
- Potter Hiram, deceased February 1, 1876
- Potter Otis R. mason, house 46 Hamilton pl.
- Potter Sophia J. vestmaker, boards 46 Hamilton place
- Potter Wm. J. polisher, boards 100 Mill
- Potter——, tinsmith, house 76 Tappan
- Pottle Edward L. h. Lake View n. Lake av.
- Pottor Allison J. clerk, b. 23 University av.
- Pover Frederick, carpenter, h. 37 William
- Powell Albert J. plumber, 96 E. Main, b. 34 Hamilton place
- Powell Amanda, widow, boards 49 Lake av.
- Powell Bridget, widow, house 80 South av.
- Powell Cornelia, widow, house 38 Bartlett
- Powell Edward, clerk, 45 Fitzhugh, boards, 42½ do.
- Powell George, clerk, boards 34 Greig
- Powell George H. carpenter, 97 Exchange, house 34 Hamilton place [Greig]
- Powell Harry T. clerk, 74 State, boards 34
- Powell Michael, teamster, house 26 Cady
- Powell William, lawyer, house 34 Greig
- Powell William jr. deceased Oct. 27, 1875
- Powell William J. carpenter, 97 Exchange, boards 34 Hamilton place
- Power Ellen, boards 64 William
- Power Emmett A. removed from city
- Power James, boards 7 Brown's alley
- Power Wm. bar tender, Clinton Hotel, b. do.
- Powers Augusta Mrs. house 128 West Main
- Powers Catharine Miss, dressmaker, boards 66 William
- Powers Charles J. lawyer, 52 Powers' bldgs. h. 107 W. Main
- P**OWERS DANIEL W. banker, W. Main cor. State, house East avenue c. Prince.—See page 500
- Powers Eliza Mrs. boards 162 West Main
- P**OWERS JAMES, stone cutter and contractor, 97 N. St. Paul, house 18 Ward.—See page 646
- Powers James, laborer, house Chili road near West avenue [52 Frank]
- Powers John, chair finisher, 184 State, bds.
- Powers John, clerk, 37 State, h. 147 Hunter
- Powers John J. framemaker, 126 State, h. 41½ Romeyn
- Powers Margaret, laundress, Congress Hall, boards do. [147 Hunter]
- Powers Michael, stonecutter, 54 Fitzhugh, b.
- Powers Nancy J. widow, boards 31 Tappan
- Powers Pierre C. carriage painter, 3 Canal, house 14 North Frances [Paul]
- Powers Thomas blacksmith, boards 96 S. St.
- Powers Thomas, waiter, 29 Powers' bldgs. boards 27 Fitzhugh [Hunter]
- Powers William, moulder, 8 Hill, boards 147
- Powers William M. carriage painter, 3 Canal, house 76 Troup
- Powis Henry, house 1 Greig
- Pownall Emma, weaver, house 65 Thompson
- Pownall James, removed from city
- Pownall William H. safemaker, 188 State, house 65 Thompson
- Praedel Christian, laborer, house 24 Lincoln
- Prange Louis F. removed to Buffalo
- Pratt Alice M. Miss, boards 318 State
- Pratt Emeline J. Miss, teacher, Church Home, 126 Mt. Hope av. boards do.
- Pratt Ezra, boards 28 Elizabeth
- Pratt George A. removed to Palmyra, N. Y.
- Pratt George S. student, Roch. Theological Seminary, boards Trevor Hall
- Pratt Ira (Pratt & Weed), house 28 Elizabeth
- Pratt Jane Mrs. removed to Newark
- Pratt Jesse D. student, boards 2 Elm

PRATT LUTHER A. boots and shoes, 54 State, house 52 Sophia.—*See page 540*
Pratt L. W. agent, boards 100 Mill
Pratt William, gardener, house 155 South av.
Pratt Willis C. removed to Illinois
PRATT & WEED (*Ira Pratt and Eli Weed*), baggage express, 92 Mill.—*See page 604*
Pray Edward W. clergyman, h. 24 Park av.
Pray George B. boatbuilder, h. 8 Kent alley
Predmore Byron, house 24 Pearl
Predmore Elizabeth, deceased May 5, 1876
Predmore Francis, caulker, h. 27 Monroe av.
Predmore Henry, grocer, at weighlock, rear 133 South St. Paul, house do.
Prehn Henry, laborer, house 120 Meigs
Preissner Frank, watchman, Aqueduct st. house Hollenbeck
Prentice Alexander jr. (*A. Prentice & Son*), boards 37 Sophia
PRENTICE ALEXANDER & SON (*A. Prentice jr.*), lumber, 158 Lake avenue, house 79 do.—*See page 650*
Prentice Anna A. Mrs. house 49 Platt
Prentice Annie, domestic, bds. 315 E. Main
Prentice Charles B. cutter, 75 North Water, boards 41 North St. Paul
Prentice Louis M. removed from city
Prentice William A. bookkeeper, 158 Lake avenue, boards 79 do.
Prentiss John B. sup't American Express Co. 83 State, boards 32 North
Prescott Robert, laborer, house 44 Hunter
Prescott Robert jr. framemaker, boards 44 Hunter
Prestele Joseph, artist, house 89 Hickory
Prestin Frederick, wagonmaker, 35 South St. Paul, house 11 Buchan park
Prestin Mary, widow, bds. 17 Buchan park
Preston Byron I. physician, 16 Chestnut, house 19 do.
Preston Charles D. trader, house 33 Asylum
Preston Delia Mrs. house 18 Caledonia av.
Preston Elisha S. physician, 16 Chestnut, house do. [man
Preston Francis M. teamster, house 50 Good
Preston Jenny L. clerk, 40 Fitzhugh, boards 45 South Ford
Preston Lucy, removed to Dansville
Preston Willard T. cutter, h. 37 Chestnut
Preuss August T. baker, 223 E. Main, h. do.
Preuss John, dyer, Mill corner Platt
Prevost Isidore E. physician, house 15 Gibbs
Prevotel Isidore, removed to Canada
Price Albert L. bookkeeper, 111½ N. Water, house 28 Prospect
Price Anner Miss, nurse, boards 47 Chestnut
Price Harris, tailor, house 44 Catharine
Prico John R. clerk, house 1 Lawrence
Price John W. cabinetmaker, 7 N. Water, boards 24 Wilson
Price Michael, foreman, Allen corner North Washington, house 65 Nassau
Price Philip, carpenter, house 1 Lawrence
Price Richard B. rem'd to Dublin, Ireland
Price Wilson S. foreman, 153 North Water, boards 1 Lawrence
Prichard James D. farmer, house 58 Kent

Prichard Wells H. teamster, boards 58 Kent
Pricher Eddie W. clerk, 73 East Main, bds. 62 William
Pridmore Abraham, machinist, Vacuum Oil Works, house 109 Tremont
Priem Charles, clothing, 104 North av. h. do.
Prime Benjamin, deceased Sept. 22, 1875
Prime Charlotte, widow, house 32½ S. Ford
Prime George W. laborer, bds. 32½ S. Ford
Prince Charles H. M. polisher, bds. 30 Ward
Prince John, laborer, h. Tenth n. Emerson
Prince Peter, teamster, house Eleyenth near Emerson
Prindle Lizzie, dressmaker, h. 71 Sibley's bl.
Pringle George (*McConnell & Pringle*), 107 S. St. Paul, h. 75 Court
Pringle George H. street sprinkler, b.75 Court
Pringle Robert H. clerk, 126 Plymouth av. boards 15 Monroe avenue
Pringle Sarah, widow, boards 85 Court
Prior Ellen, domestic, bds. 57 Lake avenue
Pritchard Alfred R. deceased March, 1876
PRITCHARD A. R. & LIKLY (*H. Likly*), trunks, bags, &c. 78 State.—*See foot lines through book*
Pritchard David, removed to N. Y. city
Pritchard John, painter, bds. 97 Tremont
Pritchard John W. deceased 1875
Pritchard Marquis L. grocer, 8 East avenue, boards 9 Elm
Pritchard Mary M. widow, house 9 Elm
Pritchard R. C. student, University of Rochester, boards 10 Joslyn park
Pritchard Susan, widow, house 4 Jones av.
Pritchard Thomas H. salesman, Allen c. N. Washington, house 60 Lake avenue
Pritchard Thomas W. shoemaker, 111½ State, house 97 Tremont [97 Tremont
Pritchard Thomas W. painter, 3 Canal, bds.
Pritchard William H. clerk, b. 100 North av.
Pritcher William, clerk, 17 State, boards 15 Asylum [ford near Hudson
Pritzbuier John, shoemaker, 15 Mill, h. Clif-
Probst Godfrey, lockmaker, Court c. Stone, bds. 68 S. St. Paul [36 Marshall
Proctor Charles A. agent, 55 S. St. Paul, h.
Proctor Josiah, boards 4 Tremont
Proctor Matilda, widow, h. 32 McDonald av.
Proctor Thomas, sup't, 36 West Main, house 40 Allen
Proctor Truman A. (*Proctor & Allen*), house 43 Sophia [dentists, 14 State
Proctor & Allen (*T. A. Proctor and N. Allen*),
Prouk Helena, widow, boards 25 Catharine
Proper Carl, chairmaker, lower falls, house Ninth near Rowe
Propping Ferdinand, teacher, h. 45 Andrews
Prosser Annie Miss, bds. 22 North St. Paul
Prost Philip, wagonmaker, 170 East Main, h. 11½ Monroe av.
Prouty Cyrus A. mechanical engineer, house 5 Lorimer [N. Water
Prozell Lewis, blacksmith, 3 Canal, bds. 116
Prue Sarah, widow, boards 77 Allen
Prussia Frank B. removed to Dansville
Pruyne Charles E. salesman, 50 Mill, house at Mexico [26 Jones
Pruyn Edgar E. fireman, N. Y. C. R. R. b.

HENRY C. WISNER,

DECORATED CHINA, SILVER SETS, No. 33 STATE STREET,

Pruyn John S. painter, house 26 Jones
 Pruyv Melvina Mrs. boarding house, 26 Jones
 Pruyv William W. carpenter, house 318 State
 Pryor Frank S. removed to Buffalo
 Pryor Henry H. (*Woodbury, Booth & Pryor*), 138 Mill, house 40 Jones
 Pryor Samuel V. salesman, 92 State, boards 13 Pleasant [22 Platt
 Pryor Thomas, patternmaker, 138 Mill, house
 Pryor Thomas P. bookkeeper, 81 N. Water, boards 22 Platt.
 Pryor William, shoemaker, house 50 Kirk
 Pufpaff Charles, varnisher, 7 North Water, house 37 Lancaster
 Pugh Charlotte E. Mrs. teacher, Concord School No. 18, house 10 Philander
 Pugh Mercy E. widow, house 95 Alexander
 Pugsley Alvin, engineer, N. Y. C. R. R. h. 18 Oregon [n. Genesee
 Puhl Michael, laborer, 20 Court, h. Magnolia
 Pulford Sarah, nurse, 61 Lake avenue
 Pullis Catharine, widow, house 91 S. Union
 Pullman Jane M. Mrs. house 7 Elm
 Puls Charles F. sawyer, 3 Aqueduct, house 57 Campbell
 Punch Edward A. student, bds. 20 Atwater
 Punch John, clerk, 4 S. Clinton, b. 20 Atwater
 Punch Patrick, hackman, house 62 St. Joseph
 Punch Richard J. upholsterer, 7 N. Water, b. 62 St. Joseph [h. 20 Atwater
 Punch William, undertaker, 4 South Clinton,
 Punnett Ephraim, carpenter, h. 25 Orange
 Punnett Reuben, carpenter, 18 Magne, h. do.
 Punnett Reuben A. cutter, 7 N. Clinton, b. 18 Magne
 Punnett William, bookkeeper, b. 18 Magne
 Purcell Edward B. engraver, Mill cor. Exchange place, house 138 West Main
 Purcell James, laborer, boards 94 Exchange
 Purcell James, bridge builder, house Goodman near Harvard [South
 Purcell John, carpenter, 20 Court, boards 26
 Purcell John T. laborer, b. r. 54 S. St. Paul
 Purcell Mary, widow, h. r. 54 South St. Paul
 Purcell Mary Miss, teacher, Chestnut School No. 11, bds. 9 Frank [avenue
 Purcell Michael, clergyman, b. 127 Plymouth
 Purcell Thomas, inspector, house 9 Frank
 Purcell Thomas E. painter, boards 26 South
 Purcell William, plasterer, 16 Stone
 Purcell William, editor, Union & Advertiser 82 West Main, house Lake view
 Purcell William D. slater, boards 26 South
 Purcell William F. removed to N. Y. city
 Purdy Albert E. removed to Warsaw
 Purdy Alexander M. editor, 33 Arcade, h. Nichols park
 Purdy Edwin B. painter, bds. 43 South av.
 Purdy Franklin E. clerk, 106 West Main, h. 38 Atkinson
 Purdy Samuel M. whipmaker, h. 43 South av.
 Purtil John, carpenter, boards 78 Cypress
 Purtil Patrick, laborer, boards 78 Cypress
 Purtil Thomas, nurseryman, bds. 78 Cypress
 Putnam Elizabeth, widow, bds. 15 Matthews
 Putnam John H. carpenter, west end Court street bridge, boards 40 South avenue

Putnam Joseph, miller, house 9 Rowley
 Putnam Josiah H. (*Putnam & Graves*), 95 Powers' buildings, house 40 South av.
 Putnam Mary S. boarding house, 59 Fitzhugh
 Putnam Warren W. painter, h. 28 Hudson
 Putnam William M. machinist, Brown cor. Jones, house 7 Montrose
 Putnam W. Emory, wheelmaker, 3 Elizabeth, house 218 W. Main
PUTNAM & GRAVES (*J. H. Putnam and W. J. Graves*), architects, 95 Powers' buildings.—*See page 511*
 Putney Alverdo, carver, house 61 Baden
 Pye David W. removed to Greece
 Pye George, butcher, 42 Lake av. b. 2 Spencer
 Pye John J. house 2 Spencer [23 Smith
 Pyne John, laborer, Brown c. Jones, house
 Pyne Thomas, cutter, house 66 Magne
 Pyott Henry H. (*Hallowell & Willis*), 39 N. Water, house 25 Troup

QUACKENBUSH JAMES, sawyer, Aqueduct n. canal, h. Orchard n. Orange
 Quackenbush Nancy, widow, boards 37 Hamilton place [avenue
 Quada Herman, laborer, bds. 10 McDonald
 Quada Johanna, widow, b. 10 McDonald av.
 Qualtrough Charles S. printer, b. 11 Jones
 Qualtrough Edward F., U. S. N., b. 11 Jones
 Qualtrough Fred. G. clerk, 2 Mumford, bds. 11 Jones
 Qualtrough John, blacksmith, Brown cor. Jones, house 5 Lime [11 Jones
 Qualtrough Joseph, Dep. Street Sup. house
 Qualtrough Libbie M. teacher Central School, No. 5, boards 5 Lime
 Qualtrough Martin, mason, h. 17 Sycamore
 Qualtrough Robert, bricklayer, boards 17 Sycamore
 Qualtrough Thomas, mason, b. 17 Sycamore
 Qualtrough William H. carrier, Post Office, house Alert Hose house
 Quambusch William (*Quambusch & Henry*), house 53 Lancaster
 Quambusch & Henry (*W. Quambusch and Jas. Henry*), ales, 127 E. Main
 Quandt Adam, brewer, b. Cliff n. Lake av.
 Quanst George C. carpenter, 187 W. Main, house Hollister n. Channing
 Quanz George A. shoemaker, house 210 Pinnacle avenue
 Quarles H. Ella, teacher, b. 110 Lake avenue
 Quayle Carrie, domestic, boards 45 Park av.
 Quenzer Charles, deceased March 8, 1876
 Quenzer John, carpenter, boards 26 Grape
 Quenzer Lizzie, widow, house 26 Grape
 Queru Edmond, chemist, 111 W. Main, bds. 146½ W. Main
 Quetschenbach Conrad, teamster, 17 Warehouse, house 189 Jay [White alley
 Quetschenbach Ignatz, laborer, house 40
 Quetschenbach Michael R. laborer, lower falls, boards 40 White alley [house do.
 Quetschenbach Michael V. saloon, 39 Front,
 Quetschenbach Valentine, laborer, house Lorimer near Thompson
 Quetschenbach Wolf, trunkmaker, ft. Rowe bds. 189 Jay

- Quick Amelia L. Mrs. dressmaker, 114 E. Main, h. do.
- Quigley Bridget Mrs. house 10 Delevan
- Quigley Charles H. mason, house 21 West
- Quigley Edward, waiter, Osburn House
- Quigley Edward, clerk, boards 3 Granger
- Quigley Elizabeth Miss, boards 46 Romeyn
- Quigley G. Frank, teamster, boards 21 West
- Quigley James, carpenter, house 43 Campbell
- Quigley John M. packer, 64 State, boards 43 Campbell
- Quigley Matthew, silverplater, 80 State, h. 31 Broadway
- Quigley Roxey A. widow, house 21 West
- Quigley Thomas, clerk, 64 State, boards 43 Campbell
- Quigley William, waiter, Congress Hall, h. 3 Granger [h. 247 State
- Quigley William H. waiter, Congress Hall,
- Quill John F. salesman, h. 22 Anderson av.
- Quin John, contractor, 84 North av. h. do.
- Quin Susanna R. Miss, h. 84 North avenue
- Quinby Frank, clerk, boards 18 Prince
- Quinby Henry, house 15 Comfort
- Quinby Isaac F. prof. University of Roch. and U. S. marshal, northern dist. of N. Y., 27 State, house 18 Prince
- Quine Robert, stonemason, house 32 Lowell
- Quine William, mason, house 52 Chatham
- Quine William W. machinist, 100 South St. Paul, boards 31 Atwater
- Quinlan Dennis, blacksmith, 57 West av. house rear 71 Adams
- Quinlan John, truckman, house 77 Atkinson
- Quinlan John, blacksmith, State cor. Centre, house 41 Romeyn [Reynolds
- Quinlan Joseph laborer, house Strong near
- Quinlan Mary A. boards 6 Hand
- Quinlan Michal T. carriage trimmer, 3 Canal, boards S. Ford r. 71 Adams
- Quinlan Michael, engineer, h. 73 Atwater
- Quinlaven John, house 20 Romeyn
- Quinlaven John jr. blacksmith, h. 105 Oak
- Quinlaven Mary, dressmaker, b. 20 Romeyn
- Quinlaven Michael, removed to Cleveland, O.
- Quinlaven Thomas, blacksmith, boards 20 Romeyn
- Quinn Agnes, stitcher, boards 3 South
- Quinn Catharine, embroidery, b. 17 Lyell
- Quinn Charles, laborer, house 97 Campbell
- Quinn Charles, carpenter, h. 106 N. St. Paul
- Quinn Charles E. A. salesman, 53 E. Main, boards 56 Andrews
- Quinn Edward, laborer, bds. 17 Orchard
- Quinn Edward S. teamster, h. 1 Summer
- Quinn Elizabeth, domestic, b. 77 East av.
- Quinn Ellinor, dressmaker, b. 12 Marietta
- Quinn Fanny E. carpet maker, b. 126 Oak
- Quinn Frank, shoemaker, 79 N. Water, b. 64 Frances [17 Lyell
- Quinn Henry J. clerk, 29 Powers' bldgs. bds.
- Quinn Hugh H. laborer, house 179 Exchange
- Quinn John, laborer, at Gas Works, house Reynolds near Strong
- Quinn John, janitor, 126 W. Main, house do.
- Quinn Margaret, dressmaker, 48 Frank, h. do.
- Quinn Mark, cooper, house 22 Orchard
- Quinn Mark jr. laborer, boards 22 Orchard
- Quinn Mary, widow, house 12 Marietta
- Quinn Mrs. house 218 West Main
- Quinn Matthew, laborer, h. Frances c. Flint
- Quinn Michael, clerk, 84 West Main, house 57 Caledonia avenue
- Quinn Michael, teamster, house 31 Munger
- Quinn Michael R. clerk, 24 W. Main, house 56 Andrews
- Quinn Patrick, house 77 Frank
- Quinn Patrick, cooper, boards 22 Orchard
- Quinn Patrick, laborer, Gas Works, house 74 Broadway [126 Oak
- Quinn Peter, laborer, Platt cor. Kent, house
- Quinn P. Frank, salesman, 53 East Main, b. 52 Andrews
- Quinn Richard H. carpenter, house 25 Favor
- Quinn Robert, laborer, h. Cottage n. canal
- Quinn Rose, widow, house 17 Lyell
- Quinn Terence, laborer, house 85 Hickory
- Quinn Terence C. shoemaker, 111 State, bds. 5 Chatham
- Quinn Terence F. driver, 33 Fitzhugh, b. do.
- Quinn Thomas, mason, house 86 Cady
- Quinn William, laborer, boards 22 Orchard
- Quirk Annie, nurse, boards 126 Alexander
- Quirk Daniel L. warehouseman, 5 Aqueduct, house 105 Mt. Hope avenue
- Quirk Edward, painter, boards 5 Bolivar
- Quirk Frances T. buttonmaker, b. 5 Bolivar
- Quirk James, wheelmaker, 3 Canal, house 5 Bolivar
- Quirk Mary, domestic, Osburn House
- Quirk Thomas, carriagemaker, bds. 5 Bolivar
- Quwanz John, cabinet maker, boards 116 Pinnacle avenue
- RAAB ANDREW, clerk, 41 Andrews, bds. 279 North Clinton
- Raab Elizabeth, widow, h. 279 N. Clinton
- Raab George, baker, 240 N. Clinton, bds. do.
- Raab Gottlieb, butcher, Oakman c. Galusha, boards 279 North Clinton
- Raab Henry, shoemaker, 79 N. Water, house 315 North Clinton
- Raab Henry jr. shoemaker, h. 53 Herman
- Raab John, boots and shoes, 194 N. Clinton, house 21 Catharine [Clinton
- Raab John L. polisher, boards 279 North
- Raab Lorens, house 275 North Clinton
- Raab Margareta, widow, bds. 21 Catharine
- Rabbitt Edward D. moulder, 20 Court, house 55 Strong [Genesee
- Rabit Anna, thermometer maker, boards 9
- Rabou Mary Louisa, widow, house 69 Cady
- Race Edwin S. clerk, Platt cor. Kent, bds. 49 Chestnut
- Race Rebecca M. widow, bds. 49 Chestnut
- Race William W. boards 49 Chestnut
- Rachdorf Matilda, widow, boards 51 Gibbs
- Rachow Frederick, laborer, house 4 Bay
- Radeliffe Benjamin S. removed to Bergen
- Radeliffe Charles, currier, house 22 Ward
- Radeliffe Chas. T. leather dresser, b. 22 Ward
- Radeliffe Cora Miss, seamstress, b. 22 Ward
- Rademaker Lizzy, dressmaker, h. 32 Frank
- Radenhurst William N. asst engineer, State canals, 153 Powers' bldgs. bds. 12 Canal
- Radensky Anthony, laborer, house 10 Joiner

Rader John, laborer, house 23 German
 Radler Annie, boards 2 University avenue
 Radler Moses, manufacturer, h. 2 University avenue
 Radler Rosa, milliner, bds. 2 University av.
 Radney Reuben I. polisher, 123 Mill, house 19 Martin
 Radort Gertrude, widow, h. Brown cor. Allen
 Raepfel Alfred L. tailor, boards 51 Nassau
 Raepfel Philip, tailor, house 51 Nassau
 Rafferty Martin J. student, 46 Arcade, bds. 98 North St. Paul
 Rafferty Thomas, laborer, b. Mansion n. canal
 Rafter Geo. W. surveyor, h. 107 West Main
 Ragan Ann, widow, house 88 Chatham
 Ragan Bridget, widow, house 19 Lancaster
 Ragan Catharine, boarding house, 37 Frank
 Ragan Hugh, stonecutter, bds. 19 Lancaster
 Ragan Johanna, boards 15 Munger
 Ragan John, stonecutter, 54 Fitzhugh, boards 121 Adams
 Ragan John, hackman, house 30 Kirk
 Ragan John, boards 112 Atkinson
 Ragan John B. carpenter, h. 63 West avenue
 Ragan Julia, widow, bds. 32 S. Washington
 Ragan Lawrence, laborer, house Mt. Hope avenue opp. nursery
 Ragan Margaret, widow, house Frances cor. Champlain
 Ragan Mary, widow, house 112 Atkinson
 Ragan Mary A. stitcher, boards 112 Adams
 Ragan Michael, laborer, house 112 Adams
 Ragan Nicholas, teamster, h. Brown's alley near Jay
 Ragan Sarah Miss, tailoress, b. 112 Atkinson
 Ragan Thomas, laborer, boards 121 Adams
 Ragon James, house 136 University avenue
 Ragon John, painter, 14 Stone [av.
 Ragon Mary A. seamstress, b. 136 University
 Rahn Anton C. (*Mensing, Rahn & Stecher*), 7 Market, house 133 North Clinton
 Raines Eugene, clerk, boards 24 Spring
 Raines Geo. dist. attorney, and (*McDonald & Raines*), 1 Court House, bds. Whitcomb House
 Raines Thomas, house 24 Spring
 Raines William G. house 24 Spring
 Raisner Louis, carpenter, boards 162 Jay
 Raisner Theodore, carpenter, Rowe near Lake avenue, house 162 Jay
 Rake Joseph H. S. carpenter, h. 78 Broadway
 Raker John B. jr. laborer, house 55 Smith
 Ralph Mary E. Miss, boards 167 State
 Ralph S. K. Mrs. boards 10 New York
 Ralph William, carpenter, house 1 Erie
 Ralph William H. engineer, house 11 John
 Ramble Carrie A. stitcher, bds. 26 Smith
 Ramble Susan, widow, house 26 Smith
 Ramble William H. laborer, bds. 26 Smith
 Ramble Wm. H. jr. painter, 111½ N. Water, boards 26 Smith
 Rampe Charles W. (*Kalb, Hahn & Co.*), 5 Mumford, house 208 North Clinton
 Rampe Wm. F. removed to Niagara Falls
 Ramsay David, millwright, 13 S. Water, h. Michigan corner Sherman
 Ramsay William, tea store, 119 East Main, boards 21 North St. Paul

Ramsdale William C. student, University of Rochester, boards 17 Matthews
RAMSDELL GEO. D. designer and photo-engraver, 142 Powers' bldgs. boards 1 Stettheimer park.—*See page 520*
 Ramsdell Gideon, house East av. cor. Meigs
 Ramsdell Helen Miss, bds. 254 N. St. Paul
 Ramsdell Laura, widow, h. 1 Stettheimer pk.
 Ramsey John, laborer, boards 61 Cypress
 Ramsey Peter B. grocer, 93 Lake av. h. do.
 Ramson John F. teamster, 17 Warehouse, h. 72 Platt [University, h. 7 Smith
 Randall Almeron W. teacher, Roch. Business
 Randall Andrew A. removed to Somerset
 Randall Henry P. blacksmith, h. 45 Pearl
RANDALL HENRY S. crockery, china, &c. 51 State, h. 27 do.—*See back cover*
 Randall Nathaniel B. removed to E. Palmyra
 Randall Robert B. (*Clague, Randall & Co.*), 1 Aqueduct cor. Race, b. 41 Clinton pl.
 Randall Van B. gunsmith, 3 West Main, h. 95 Weld
 Randell Edmund, scavenger, house 1 Pine
 Randell Jesse, mover, h. North York n. R. R.
 Randles James, shoefitter, 111½ N. Water, h. Saratoga av. near Costar [n. Costar
 Randles Mary E. stitcher, bds. Saratoga av.
 Randolph Betsy A. widow, h. 10 St. Joseph
 Randolph Franklin B. machinist, boards 10 St. Joseph [No. 13, b. 61 Alexander
 Randolph L. Annie, teacher, Munger School,
 Randolph Mary E. news depot, 130 North St. Paul, house do.
 Randolph Samuel N. cooper, b. 10 St. Joseph
 Randtke Fred. laborer, house Hoeltzer near St. Joseph
 Rankin Dugal, removed to Toronto, Ont.
 Rankin John, overseer, Rochester Cotton Mill, foot Centre, house 44 Ambrose
 Rankin Julian H. printer, bds. 44 Ambrose
 Rankin J. William, screw cutter, boards 44 Ambrose [pion
 Rankin William, contractor, house 2 Cham-
 Ranlet Horace E. boatman, bds. 54 West av.
 Ranney Frank G. (*Ranney & Baker*), house 12 Jones avenue [house 18 Frank
 Ranney Julius A. filters, 8 Exchange place,
 Ranney & Baker (*F. G. Ranney and G. L. Baker*), gents' furnishing goods, 20 State
 Ransom Elijah, laborer, bds. 2½ School alley
 Ransom Henry S. stable, 3 Stone, house 49 Chestnut [Rochester, h. 48 Charlotte
 Ransom J. Clinton, student, University of
 Rantz Anthony, filecutter, house 26 Mark
 Rapalje Harriet A. widow, house 29 South
 Rapalje John, agricultural warehouse, 159 West Main, and (*H. D. Sargent & Co.*), house 35 Spring
 Raphols Frank, mason, house 59 North av.
 Rapp Catharine, widow, house 35 Wilder
 Rapp Chas. blacksmith, Lyell n. Sherman, house do. [Sherman
 Rapp Frederick, blacksmith, bds. Lyell near
 Rapp Frederick, house 23 Weld
 Rapp Frederick B. confectioner, h. 5 Swan
 Rapp George, machinist, boards 35 Wilder
 Rapp George W. planer, 3 Elizabeth, house 61 Kirk

Rapp George W. blacksmith, 3 Canal, house
23 Prospect [Weld
Rapp Jacob, wheelmaker, 3 Elizabeth, b. 23
Rapp John, blacksmith, Lyell near Sherman,
house Orchard near Lyell
Rapp Peter, clerk, 53 East Main, h. 1 Pitt
Rapp Peter, clerk, 6 S. St. Paul, b. 23 Weld
Rapp Wm. tailor, 35 State, h. 158 N. St. Paul
Rappleeya J. C. Mrs. house 34 Park avenue
Rappleey Nicholas B. casket trimmer, 87
Exchange, boards 34 Park avenue
Raraty Margaret, widow, house 9 Manhattan
Raschke Rudolph, laborer, h. 18 Elizabeth pl.
Rasser Christopher, grocer, Brown c. Allen,
house do. [16 N. Frances
Ratcliffe James, fishing tackle, 14 Arcade, h.
Ratelle Joseph C. shoemaker, 111 State, bds.
97½ East Main
Rathbun Charles H. (*Whitmore, Brady &*
Co.), house at Buffalo
Rathbun Lavega, removed from city
Rathbun Sarah, widow, house 81 Hickory
Ratler Moses, house 2 University avenue
Ratt Frank C. carpenter, 3 Aqueduct, h. 46
Oakland park
Ratt George, mason, house 25 Alexander
Ratt James, carpenter, 3 Aqueduct, boards
Alexander park near Comfort
Ratt William, carpenter, 3 Aqueduct, house
7 Alexander park [16 Whitmore park
Ratt William H. carpenter, 3 Aqueduct, h.
Rau Andrew, brewer, boards 1 Cliff
Rau Charles, h. 108 N. Clinton c. Marietta
Rau Francis J. removed to Germany
Rau Gertrude, widow, house 60 N. St. Paul,
Rau Gustavus, saloon, 7 Mumford, house do.
Rau Joseph, lawyer, 10 Smith's block, house
101 N. St. Paul [101 N. St. Paul
Rau Josephine, teacher, 7 Mortimer, boards
Rauber Christina Mrs. h. Walnut n. Orange
Rauber Jacob, saloon, 136 W. Main, h. do.
Rauber Jacob, cigar maker, h. 1 Clinton pl.
Rauber Jacob, house 2 Rauber
Rauber Jacob jr. teamster, bds. 2 Rauber
Rauber John (*Whitmore, Rauber & Vicinus*),
house 221 N. Clinton [b. do.
Rauber John, beer peddler, 111 N. St. Paul
Rauber John E. clerk, Bank court, boards
2 Rauber [tory, h. 12 Rauber
Rauber Nicholas, cigar maker, Mill c. Fac-
Rauber Nicholas, hostler, 159 State, house 4
North Ford [boards do.
Rauber Peter F. bookkeeper, 132 W. Main,
Rauber Stephen, flour and grain, 155 W. Main,
house 18 Rauber [4 N. Ford
Rauber Stephen 2d, clerk, 155 W. Main, b.
Rauch Frederick, laborer, house 5 Ontario
Rauch John, laborer, 38 Gorham, house 16
Wilson [Clinton, house do.
Rauch John J. sewing machines, 197 North
Raufeisen Catharine, widow, house 41 Rhine
Raufeisen John M. clerk, 61 State, b. 41 Rhine
Rauh Salome, widow, boards 7 Selden
Rauback Joseph, mason, house 6 Leopold
Rausch John, shoemaker, 174 West avenue,
house do.
Rausch Michael, laborer, house 92 Orange
Rauschenberg Adam, laborer, b. 12 Kondolf

Rauschenberg Catharine, widow, boards 109
Champlain [12 Kondolf
Rauschenberg Christian, heading jointer, b.
Rauschenberg Helaeraus, sawyer, 184 State,
house 12 Kondolf
Rauschenbusch Augustus, professor, Theo-
logical Seminary, house 10 Arnold park
Raussert Lawrence, porter, 13 West Main,
house 1 Dover
Rautenstrauch J. Henry, spectacle frame
maker, 179 N. St. Paul, house 48 Lowell
Raveret Augustus, boards 36 South avenue
Rawdon John, laborer, 8 White, h. Oak n.
Smith
Rawleigh C. H. peddler, 144 East Main
Rawlins Esther, clerk, boards 53 Jay
Rawlings John J. janitor, 9 S. Washington,
h. 2 West alley near Troup [h. do.
Rawlings Mary C. Mrs. dressmaker, 53 Jay,
Rawson N. S. widow, house 2 Hart avenue
Rawson George W. lawyer, 18 Smith's block,
house 32 Chestnut [Plymouth av.
Ray Edward, salesman, 4 Allen, boards 29
Ray Emmett S. boards 7 Joslyn park
Ray George H. boards 30 Atwater
Ray John, engineer, house 30 Atwater
Ray J. Wainwright, insurance, h. 39 South
Union
Ray Mary Ann, widow, house 30 Atwater
Ray Myron H. baggageman, h. 7 Joslyn pk.
Ray Nancy, widow, boards 7 Joslyn park
Ray Phebe, widow, house 27 Gibbs
Ray Robert, sleeping car agent, N. Y. C. de-
pot, boards Brackett House
Ray William F. clerk, Brackett House, b. do.
Raymond Arthur W. removed to Norfolk, Va.
Raymond Christopher, laborer, h. 76 North
avenue
Raymond Edward J. asst. bookkeeper, Roch.
Savings Bank, and (*S. B. Raymond &*
Son), h. 101 Court [Bank, b. 21 Grove
Raymond Edward L. clerk, Roch. Savings
Raymond Eugenie C. Mrs. widow, house 21
Grove [Main, b. Whitcomb House
Raymond Freeborn B. harnessmaker, 103 E.
Raymond Hannah M. widow, h. 24 Monroe
avenue [Alexander
Raymond Hannah M. boards East av. cor.
Raymond Henry B. salesman, h. S. Union
corner Griffith [b. 36 Tremont
Raymond James F. shoecutter, 44 Exchange,
Raymond Robert, boards 21 Grove
Raymond Samuel B. & Son (*E. J. Raymond*),
insurance, 31 W. Main, boards European
Hotel [No. 17, h. 57 Savannah
Raymond Thos. A. principal, Whitney School,
Raymond William, house 136 Alexander
Raymond Wm. A. agent, h. 186 East Main
Raymond William O. cutter, 14 Elwood blk.
house 24 Monroe avenue
Raynarts Levi, house 48 Joiner
Raynarts Samuel, peddler, boards 48 Joiner
Raynesford Cyrus C. salesman, h. 71 Smith's
block [boards 71 Smith's block
Raynesford Jas. A. student, Univ. of Roch.
Rays Peter, cooper, 30 Canal, h. 6 Kondolf
Rea Thomas, laborer, h. Hague n. Railroad
Read Carrie T. widow, boards 28 Adams

Read Gilbert L. house 242 North St. Paul
 Read John, shoemaker, 75 N. Water, boards
 Oak corner Lind
 Read Mary, widow, house Oak corner Lind
 Read Nicholas, laborer, h. West Maple near
 Ames
 Read Welthea, widow, bds. 242 N. St. Paul
 Read see Reed and Reid
 Readshaw William J. removed to Dansville
 Ready Charles, laborer, house Ridge road n.
 Lake avenue
 Reaner Chas. shoemaker, house 59 Lancaster
 Reaner Jeremiah, laborer, house 66 Bartlett
 Reaner Michael, boatman, boards 66 Bartlett
 Reardon Bridget, widow, h. 15 Vincent pl.
 Reardon Dennis, saloon, 91 Mill, bds. Frank
 corner Jay
 Reardon Dennis, boards 86 Mt. Hope avenue
 Reardon Hannah, widow, h. 39 South Wash-
 ington
 Reardon Margaret, widow, house 85 Meigs
 Reardon Mary, widow, house 100 Exchange
 Reardon Mary J. dressmaker, Jay c. Frank,
 house do. [51 Whitney
 Reas Joseph, blacksmith, 121 N. Water, b.
 Reath Alicia, widow, h. Seward n. Strong
 Reath William A. car overseer, h. Seward n.
 Strong
 Rebasz Charles B. engraver, 11 State, boards
 21 Adams [21 Adams
 Rebasz William M. watchmaker, 11 State, h.
 Rebasz William M. jr. organist, b. 21 Adams
 Rebhan Ferdinand, bds. 90 Mt. Hope avenue
 Rebhan Rudolf, teacher, Franklin n. North
 Clinton, house 90 Mt. Hope avenue
 Rebholz Seferin, carpenter, house Alphonse
 Recailje Peter C. milkman, house 35 Tappan
 Rece Peter, blacksmith, boards 14 Canal
 Reche F. coal dealer, 5 South av. h. 18 Howell
 Reche Vital, house 18 Howell
 Redamski Ludwig, laborer, 51 Hudson, h. 27
 Vienna
 Reddan Ignatius, removed from city [do.
 Reddan James, yardman, Congress Hall, b.
 Redding Darius W. (*Dockstader & Redding*),
 8 Centre, house 3 Bolivar
 Reddy Patrick, laborer, house 157 Jay
 Reddy Thomas J. moulder, Brown's race n.
 Furnace, boards 143 Jay
 Redfern Joseph H. sawyer, 92 Allen, h. 94 do.
 Redfern Thomas, millwright, 110 Mill, h. 30
 Ambrose
 Redfern William, machinist, Brown corner
 Jones, b. 35 Edinburgh [burn House
 Redfield Henry S. lawyer, 23 Arcade, b. Os-
 Redhead John, laborer, house 126 Frost av.
 Redhead John T. shoemaker, h. 41 Reynolds
 Redhead Joseph C. shoemaker, 124 Front, h.
 55 Frost avenue [Reynolds
 Redhead Joseph C. Mrs. dressmaker, h. 100
 Redhead William A. clerk, 94 Plymouth av.
 boards 126 Frost avenue [Bernard
 Redinger August, laborer, b. Hudson near
 Redington Patrick, teamster, 54 Fitzhugh,
 h. Waverley pl. n. Genesee Valley canal
 Redington Thos. teamster, 163 Exchange, h.
 Waverley place n. Genesee Valley canal
 Redman Anna, widow, house 2 Goodman

Redman George A. bookkeeper, 11 Arcade,
 house 21 Meigs
 Redman Henry S. removed from city
 Redman Julia A. removed to Jamestown
 Redman Wm. J. removed to Canada
 Redman William W. agent, 93 State, boards
 58 Frank [bds. 20 Ambrose
 Redmond Edmond, reporter, 82 West Main,
 Redmond Edward M. editor, b. 29 Ambrose
 Redmond Johanna, widow, h. Myrtle n. Lyell
 Redmond Lizzie A. teacher, Whitney School,
 No. 17, boards 20 Ambrose
 Redmond Mary Miss, domestic, 48 Allen
 Redmond Michael J. cooper, house 17 Lyell
 Redmond Owen, machinist, h. 20 Ambrose
 Redrick Thomas B. steward, Rochester Club,
 35 State, boards 105 Mill [Reynolds
 Reed Bernard, laborer, boards Tremont near
 Reed Edgar P. (*Reed & Weaver*), house 15
 Chatham
 Reed Edward, agent, boards 2 Oak
 Reed Elizabeth, widow, boards 35 North av.
 Reed Francis, finisher, 3 Canal, b. 68 Adams
 Reed Hiram H. clerk, 106 State, h. 26 Wilder
 Reed James, gardener, bds. Chili road near
 city line [39 Munger
 Reed James N. tailor, 55 Smith's blk. house
 Reed John, baker, boards 23 Kent
 Reed John, gardener, house 67 Hickory
 Reed John, clerk, 77 Mill, boards do.
 Reed Margaret, chambermaid, Osburn House
 Reed Martin M. proprietor Reed House, 77
 Mill, house do.
 Reed Michael, laborer, house 68 Adams
 Reed Mina, dressmaker, b. 14 Newton blk.
 Reed Samuel B. foreman, 87 N. Water, bds.
 16 North Clinton [bds. 35 Glasgow
 Reed Thomas C. Rev. school, 96½ E. Main,
 Reed William, laborer, 178 Plymouth av. h.
 2 Seward
 Reed William A. teacher, house 35 Glasgow
 Reed William H. seeds, 164½ State
 Reed William W. removed to Pittsford
R **REED & WEAVER** (*E. P. Reed and D. G.*
Weaver), shoe manufs. 111 State.—*See*
page 666
 Reed, see Read and Reid
 Reeder Benedict, boards 306 North Clinton
 Reeder Edward, bartender, Clinton Hotel, h.
 304 North Clinton [cor. Court
 Reeder John, marble worker, h. S. St. Paul
 Reeder Peter, carpenter, house 73 Herman
 Reedy Mary, dressmaker, boards 36 Platt
 Reeg Leonard, nurseryman, house 27 Cypress
 Reeg John, nurseryman, boards 27 Cypress
 Reese Charles H. salesman, 93 State, boards
 34 North Washington
 Reese Elizabeth, widow, boards 40 Sophia
 Reese George, shoemaker, 91 North Water,
 boards 9 St. Clair
 Reese Jacob V. deceased May, 1875
 Reese John F. (*Reese & Haskin*), 66 W. Main,
 boards European Hotel
R **REESE & HASKIN** (*J. F. Reese and*
C. H. Haskin), druggists, 66 W. Main.
See front cover
 Reeves Henry F. coachman, house 34 Ply-
 mouth avenue

Reeves James, laborer, boards 36 Munger
 Reeves James B. salesman, 73 East Main, h.
 77 Hickory
 Reeves Jennie C. widow, house 40 William
 Refior Leonard (*Walter & Refior*), 18 West
 Main, boards 151½ North avenue
 Regan Catharine, widow, house 14 Kirk
 Regan Daniel, shoemaker, 91 N. Water, h.
 47 Davis
 Regan Michael, hackman, boards 14 Kirk
 Regan, see O'Regan [cle av.
 Regenauer Catharine, widow, h. 194 Pinna-
 Reger Bolzer, machinist, boards 124 Jay
 Reger John B. house 124 Jay [124 Jay
 Reger Leonard, varnisher, 15 N. Water, bds.
 Reger Margaret, seamstress, boards 124 Jay
 Reger Sarah, seamstress, 124 Jay, boards do.
 Regina Sister, teacher, boards Jay c. Frank
 Regis Mary Sister, St. Bridget's School,
 Hand, boards Jay corner Frank
 Regnauld M'le, teacher, 33 Spring, bds. do.
 Rehberg Bonifarius, tailor, bds. 37 Rauber
 Rehberg Caspar, laborer, h. 212 Pinnacle av.
 Rehberg Charles, teamster, h. 254 N. Clinton
 Rehberg John, boat builder, house 200 Pinna-
 cle avenue
 Rehberg John jr. boards 200 Pinnacle avenue
 Rehberg Nicholas, carpenter, h. 37 Rauber
 Rehberger Amelia, dressmaker, bds. 5 Tyler
 Rehberger Caspar, boiler maker, Platt cor.
 Kent, house 61 Martin
 Rehberger Henry, cabinet maker, h. 5 Tyler
 Rehtz Frank, machinist, house 25 Kelly
 Rehtz Fred, blacksmith, 29 Mumford, bds.
 25 Kelly
 Rehwald Siegfried, deceased January, 1876
 Rehwald Rosa, widow, boards 14½ Atwater
 Reiber Albert, baker, 138 North av. h. do.
 Reiber Charles, collector, 175 S. St. Paul, h.
 119 Champlain [h. Davis c. Finney
 Reiber William, shoemaker, 91 N. Water,
 Reiber William, stonecutter, h. Lime near
 Childs [34 Comfort
 Reibling Augustus J. (*Reibling & Olcott*), h.
R **REIBLING & OLCOTT** (*A. J. Reibling*
and J. B. Olcott), insurance agents, 62
 E. Main.—*See page 510* [h. 8 Sellinger
 Reibstein Jacob, shoemaker, 77 N. Water,
 Reibstein J. Henry, harnessmaker, 51 S. St.
 Paul, house 87 North Union [Chatham
 Reich Chas. box maker, foot Centre, h. 111
 Reich Chas. J. hairdresser, Whitcomb House,
 boards 3½ Bay avenue [13 Vienna
 Reich Christian, stonecutter, 54 Fitzhugh, h.
 Reich John, cabinetmaker, 133 N. Water,
 house 3½ Bay [Clinton
 Reicheelt Richard, teacher, house 160 North
 Reichelt R. teacher, Concord School, No. 18
 Reichenbach Frank A. Miss, teacher, Gen-
 esee School, No. 4, b. 24 King [King
 Reichenbach Fred. machinist, 3 Canal, b. 24
 Reichenbach John F. physician, 24 King,
 house do. [ket, bds. 24 King
 Reichenbach Wm. F. draughtsman, 7 Mar-
 Reichenberg Baptist, butcher, house 173 Jay
 Reichenberger William V. butcher, 80 W.
 Maple, house do.
 Reichenacker Annie M. widow, h. 1 Hudson

Reichenecker Elizabeth, seamstress, boards
 1 Hudson
 Reichert George, cooper, house 242 State
 Reichert Jacob, grocer, 87 Hudson, house do.
 Reichert Joseph, clockmaker, 3 Union alley,
 house do.
 Reichert Martha, widow, house 85 S. Union
 Reichert Peter, hairdresser, 228 E. Main, h.
 Huron near St. Joseph
 Reichert Valentine (*Griffin & Reichert*), 1 S.
 St. Paul, house 31 Marietta [Childs
 Reichhart Joseph, basket maker, h. Lime n.
 Reichelt Adam, baker, 139 N. Water, house
 26 Lincoln
 Reid Alex. removed to Cincinnati, O.
 Reid Eliza, widow, boards 7 Atkinson
 Reid Eliza S. Mrs. shoe cutter, b. 25 Lake av.
 Reid Elizabeth, widow, house 50 Sophia
 Reid Mary L. widow, boards 59 Fitzhugh
 Reid Wm. shoemaker, 164 E. Main, house 13
 East [37 Asylum
 Reid Wm. G. plumber, 153 East Main, house
R **REID WILLIAM H.** seedsman, 166 State,
 boards 59 Fitzhugh.—*See page 593*
 Reif Florentine, clerk, 98 North av. b. do.
 Reif George, painter, h. Brown's a. n. Lyell
 Reif John, baker, 96 North av. house rear do.
 Reiland Anna, widow, bds. 25 North York
 Reiland Barbara, tailoress, bds. 43 Oakman
 Reiland Christian, deceased, January 1, 1876
 Reiland George, removed to Buffalo
 Reiland Joseph, carpenter, bds. 43 Oakman
 Reiland Nicholas, carpenter, 81 North Water,
 house 43 Oakman
 Reilly Harriet M. widow, bds. 87 Broadway
 Reilly Mary J. Mrs. boards 28 Centre
 Reilly Robert, stove mounter, 8 Hill, house
 22 Elizabeth
 Reily John W. clerk, house 12 S. Clinton
 Reily John W. Mrs. dressmaker, 12 South
 Clinton, house do.
 Reimers Christian, laborer, house rear Hud-
 son near Norton
 Reimmiller Henry, cooper, house 53 Orange
 Rein Ann, widow, boards 67 North Water
 Rein Barbara, widow, h. N. Clinton, near
 Flower [near Flower
 Rein George, sole cutter, boards N. Clinton
 Rein John, shoemaker, bds. N. Clinton near
 Flower [Cady
 Rein Joseph, laborer, Platt c. Kent, h. 57
 Rein Leopold, sole cutter, N. Water c. River,
 house 23 Rauber
 Reinek John, brewer, house 225 N. St. Paul
 Reineman Martzel, sausage maker, h. 264 St.
 Joseph [near Ames
 Reinfeld Christopher, shoemaker, h. W. Maple
 Reinfeld Christopher, propr. Reinfeld House,
 Lake avenue near Ridge road
 Reinfeld Jacob, shoemaker, boards 68 Smith
 Reinfeld John, shoemaker, house 68 Smith
 Reinfeld John jr. shoemaker, bds. 68 Smith
 Reinfeld John J. shoemaker, b. 78 W. Maple
 Reinfeld Joseph, shoemaker, h. 78 W. Maple
 Reinfeld Michael J. grinder, h. W. Maple n.
 Ames
 Reinfeld Sebastian, removed to Greece
 Reinhard Henry, carpenter, h. 30 N. Frances

Reinhard Julius H. carpenter, 3 Aqueduct, boards 30 N. Frances [house do.]
 Reinhard Peter, grocer, 97 Mt. Hope av.
 Reinhardt Catharine, widow, h 122 Wilder
 Reinhardt Charles, laborer, house St. Joseph near Norton [Joseph near Norton]
 Reinhardt Charles jr. machinist, boards St.
 Reinhardt Christian, upholsterer, 184 State, boards 1 Galusha
 Reinhardt Frederica, widow, h. 1 Galusha
 Reinhardt George, confectioner, 144 W. Main, house 22 Hanover
 Reinhardt Henry (*Reinhardt & Koehler*), North av. cor. Caspar, house do.
 Reinhardt William F. optician, 179 N. St. Paul, b. 1 Galusha
 Reinhardt & Koehler (*Henry Reinhardt and Andrew Koehler*), market, North avenue corner Caspar
 Reinhart Abram, saloon, 92 Exchange, h. do.
 Reinhart Frank, butcher, house Genesee n. Seward
 Reinhart Jacob, teamster, house 16 Eagle
 Reinhart John J. bricklayer, bds. 16 Eagle
 Reinhardt Joseph, butcher, boards 72 Frances
 Reinhart Julius, boatman, bds. 92 Exchange
 Reinhart Julius Mrs. house 72 West avenue
 Reinhold Louis, shoemaker, 22 Johnston blk. boards 8 Bay
 Reinking Ernst, in New York city
 Reinschmidt Peter, turner, Jay c. Erie canal, house 49 Campbell
 Reis Peter, butcher, boards 74 Gregory
 Reising Henry, carver, boards Vernon park
 Reisig Wm. laborer, house Vernon park
 Reisig Wm. jr. brewer, N. Clinton n. Clifford, house St. Joseph near Norton
 Reisinger Jacob, maltster, 106 Lake av. house Fulton avenue near Lorimer
 Reisky Emil (*Reisky & Spies*), house 111 N. St. Paul
REISKY & SPIES (*Emil Reisky and Henry Spies*), brewers, 111 North St. Paul.—*See page 563*
 Reiter Nicholas, laborer, house 23 Henry
 Reiter Nicholas jr. machinist, bds. 23 Henry
 Reiter Teresa, widow, house 36 Grand
 Relke Charles, laborer, house 80 Kelly
 Relyea Daniel, fireman, N. Y. C. R. R. b. 1 Webster
 Relyea Emeline, widow, house 155 Brown
 Relyea Frederick H. coupler, h. Lincoln n. Channing
 Relyea John, boiler maker, house 1 Webster
 Relyea John jr. machinist, boards 1 Webster
 Relyea John E. ale, 19 North av. h 33 do.
 Relyea Lodewick F. engine dispatcher, house 129 North avenue
 Relyea Thomas B. painter, house 37 Gregory
 Relyea Wm. F. machinist, house 62 Tappan
 Relyea Wm. H. engineer, N. Y. C. R. R. h. 210 Brown
 Remarque John A. foreman, 7 North Water, house 86½ Tappan
 Remich Elise, spinner, boards 51 Wilder
 Remich Joseph, stone cutter, h. 51 Wilder
 Remington Edward C. restaurant, 16 Exchange place, h. 12 Lamberton park

Remington Emma, teacher, Chestnut School, No. 11, boards 51 Spring [bds. do.]
 Remington Silas H. clerk, Clinton Hotel
 Remington Stanley, clerk, 72 East Main, b. 47 South Clinton
 Remington Stephen (*H. Brewster & Co.*), 72 E. Main, house 47 South Clinton
 Rempel Lorenz, boards 5 Rauber
RENAUD JOHN, coach painter, 17½ North avenue, house 48 King.—*See page 603*
 Renaud Michael, carriage maker, 3 Canal, house 45 Walnut
 Renaud Peter, shoemaker, house 48 King
 Renaud Peter jr. carriage trimmer, 3 Canal, house 12 East Maple
 Rene Michael, carpenter, r. Thurston road
 Rener Eugene J. clerk, Powers' bldgs. (base-ment), boards 39 North avenue
 Renfrew Jane, clerk, 88 West av. b. 106 do.
 Renfrew Robert, carpenter, h. 106 West av.
 Renfrew Robert jr. news depot, 88 West av. boards 106 do. [b. 3 Grand]
 Renker Herman, pastor, St. Boniface church,
 Renner Adam, carpenter, boards 19 Cypress
 Renner Andrew, house 69 Cypress
 Renner A. E. widow, house 19 Cypress
 Renner Charles D. (*Wager & Renner*), 2 N. St. Paul, house 35 Franklin
 Renner Charles jr. removed to Clyde
 Renner George, engineer, house 3 Wilder
 Renner Herman, removed from city
 Renner Jacob, tinsmith, boards 69 Cypress
 Renner Jacob, hairdresser, house 52 Joiner
 Renner Jacob, engineer, house 13 Wilder
 Renner Joseph, laborer, boards 38 Herman
 Renner Rosina, widow, house 38 Herman
 Rennie James, carpenter, 3 Saratoga avenue, house 37 Spencer
 Renouf Jane M. widow, b. Bolivar c. Smith
 Renovata Mary Sister, Notre Dame, Hudson corner Clifford
 Rentschler Barbara, widow, h. 71 Sanford
 Rentschler Gottlieb, laborer, house Ashland near Gregory
 Rentschler John, laborer, house 69 Sanford
 Rentschler Mary, widow, boards 69 Sanford
 Rentschler Ulrich, deceased April, 1875
 Renwick George J. mat manuf. 11C State, boards 2 Frank
 Reome Ann, widow, house 15½ Monroe av.
 Reome Louis, deceased April, 1875
 Repp Adam, peddler, house North avenue corner Clifford
 Repp Charles, boots and shoes, 151 North avenue, house 23 Holland
 Requa Garrett, butcher, house 109 Fulton av.
 Requa Josephus, dentist, 10 Masonic block, house 14 Perkins
 Requa Laura Mrs. boards 46 Oak
 Requet John, watchman, bds. Clinton Hotel
 Retalick Samuel, teamster, house Thorn n. McCracken [kins]
 Retenauer Anthony, stonecutter, h. 18½ Haw-
 Retnour Oliver P. clerk, 139 State, house 141 South avenue
 Retsch John K. teamster, bds. University av. corner Prince
 Rett Barbara, widow, house 99 Kelly

Reus Michael, baker, Brown c. W. Maple, boards do.
 Reus, see Rice and Reis [Lime
 Reuschel Frederick C. baker, 307 State, h. 54
 Reuter Christian, house 105 Chatham
 Reuter Conrad, butcher, bds. 106 Exchange
 Reuter Geo. grocer, Meigs c. Park av. h. do.
 Reuter Louise M. teacher, Monroe School, No. 15, boards Park avenue cor. Meigs
 Reuter Margaret, clerk, b. Park av. c. Meigs
 Revell James, shoemaker, 91 N. Water, bds. York House
 Rew Francis S. collector, U. S. int. rev. 7 Powers' bldgs. and editor Ev. Express, 23 W. Main, h. 8 E. Main near Stillson
 Rew Parker H. student, University of Roch. boards 8 East Main
 Reynell L. Jennie, compositor, b. 15 Joiner
 Reynell Robert F. house 15 Joiner
 Reynell R. Charles, letter carrier, Post Office, house 8 Joiner [Hugh
 Reynolds Abelard, 113 Arcade, h. 100 Fitz-
 Reynolds Ada Miss, dressmaker, boards 25 Sibley's block
 Reynolds Alfred, house 76 East avenue
 Reynolds Arthur, rem'd to Providence, R. I.
 Reynolds Charles E. organist, 193 Powers' bldgs. house 20 North Frances
 Reynolds C. Frank, clerk, 73 East Main, b. 27 Meigs
 Reynolds Dora Mrs. domestic, 67 Lake av.
 Reynolds Ezra J. deceased June, 1875
 Reynolds Frank, student, boards 125 Jones
 Reynolds Fred A. printer, boards 10 Sophia
 Reynolds George A. house 29 East avenue
 Reynolds George A. hostler, 4 Franklin, b. 98 East Main
 Reynolds George V. toolmaker, h. 125 Jones
 Reynolds Georgianna L. Mrs. bds. 34 Court
 Reynolds Gilbert H., U. S. gauger, 7 Powers' buildings, house 60 Court
 Reynolds Gilbert M. salesman, Exchange c. Court, house 61 Hickory
 Reynolds G. Stanley, salesman, 73 E. Main, boards 61 Hickory
 Reynolds Harrah J. house 5 Rowley
 Reynolds Honora, gilder, 38 Gorham, boards 21 Galusha
REYNOLDS JOHN, mesmerist and magnetic physician, 40½ Fitzhugh, h. do.—
See page 582
 Reynolds John A. physician, 10 Sophia, h. do.
 Reynolds John A. (*Brooks & Reynolds*), 139 State, house 76 East avenue
 Reynolds Jonathan, constable, h. 1 Montrose
 Reynolds Mary, seamstress, b. 189 Alexander
 Reynolds Mary, widow, b. 12 Clinton place
 Reynolds Mary, widow, house 21 Galusha
 Reynolds Mary C. hairwork, 70 State, house 12 Clinton place [Plymouth av.
 Reynolds Mortimer F. 113 Arcade, house 40
 Reynolds Philo W. clerk, 62 State, house 27 Meigs
 Reynolds Platt C. fruit plants, Norton near North St. Paul, and Rural Home Publishing Co. 31 Arcade, h. Norton near North St. Paul [der
 Reynolds Rosa A. seamstress, h. 189 Alexan-

Reynolds Thomas, shoemaker, 15 Mill, bds. Mill corner Centre
 Reynolds Thomas G. bootmaker, 92 State, b. Centre corner Mill [b. 21 Galusha
 Reynolds Timothy A. salesman, 53 E. Main
 Reynolds U. Jerome, agent, house 3½ James
 Reynolds Walter B. hostler, 3 Stone, b. do.
 Reynolds William S. bookkeeper, house Culver place near University avenue
 Rhines George, teamster, Lake avenue cor. Lyell, house 8 Pine [more
 Rhines George L. carpenter, house 4 Sycamore
 Rhines George W. F. carpenter, h. 9 Weld
 Rhines John H. carpenter, h. 18 Lancaster
 Rhines Martha, widow, h. 18 West Troup
 Rhines Peter F. carpenter, house 39 Cherry
 Rhines William H. hostler, bds. 4 Sycamore
 Rhode Henry, shoemaker, River cor. Water, house 44 Thomas
 Rhodes Frank, laborer, house 27 Monroe av.
 Rhodes Thomas L. music teacher, house 7 Whitney
 Rice Albert W. clerk, house 1 Madison
 Rice Alvah, grocer, 103 West av. house do.
 Rice Anthony, carpenter, h. N. Union n. Lewis
 Rice Catharine, widow, h. Mansion n. Violetta
 Rice Catharine, widow, house 111 Hunter
 Rice Charles, engineer, r. St. Paul, opp. Griffith, house 17 Mt. Hope av.
 Rice Charles A. P. sawyer, foot Centre, h. 67 Scrantom [Rapids
 Rice Daniel, laborer, house Plymouth av. n.
RICE EDWARD J. plumber, 16 S. St. Paul, h. 90 Strong.—*See back cover*
 Rice Edward J. painter, house 102½ E. Main
 Rice Edward R. salesman, 147 State, house at Batavia
 Rice Elliott C. box manuf. house 9 Crouch
 Rice Frances F. widow, bds. 11 Gardiner pk.
 Rice George, show case maker, b. 40. Munger
 Rice George, painter, house Bay n. Goodman
 Rice George, coachman, 29 N. St. Paul, b. do.
 Rice George F. carpenter, ft. Centre, boards 10 W. Atkinson [69 do.
 Rice George H. butcher, 63 Caledonia av. b.
 Rice George W. painter, house 23 N. Frances
 Rice Harvey E. watchmaker, 146 State, bds. 61 Savannah [boards 12 Pleasant
 Rice Henry (*Rice & Wolff*), and (*I Rice Sons*), Rice Henry, carpenter, house 122 South av.
 Rice Henry T. carver, Jay c. Erie canal, bds. rear Clinton opp. av. A.
 Rice Isabella Miss, boards 12 North Frances
 Rice Israel, 29 E. Main, house 12 Pleasant
 Rice I. Sons (*L., H. and S. Rice*), clothiers, 29 East Main
 Rice James A. carpenter, h. 13 Waverley pl.
 Rice Job O. house 108 Broadway
 Rice John, plumber, 16 S. St. Paul, boards Mansion near Flint
 Rice John E. boatbuilder, bds. 108 Broadway
 Rice Julia, widow, house 10 Magne
 Rice Lawrence, laborer, h. Culver n. Norton
 Rice Leopold (*I. Rice Sons*), bds. 12 Pleasant
 Rice Lewis, deceased April 7, 1876
 Rice Lorenz, butcher, bds. 22 University av.
 Rice Louis, clerk, Osburn House, boards 224½ East Main

HENRY C. WISNER,

CRYSTAL BUD VASES, EPERGNES, ETC., No. 33 STATE STREET.

- Rice Margaret, stitcher, boards 19 Lancaster
 Rice Margaret, widow, house 19 Lancaster
 Rice Mary, widow, h. Plymouth av. n. Rapids
 Rice Mary A. widow, house 9 Lancaster
 Rice Michael, shoemaker, 87 N. Water, bds. 86 Hunter
 Rice M. Louise, physician, boards 2 Clarissa
 Rice Nicholas J. agent, house 2 Clarissa
 Rice Obed M. broker, house 10 Atkinson
 Rice Patrick, laborer, h. Hunter c. Frances
RICE PETER, show case manuf. 87 S. St. Paul, house 40 Munger.—*See page 517*
 Rice Peter F. mason, house 48 Pinnacle av.
 Rice Richard, engineer, bds. 1 Anderson av.
 Rice Richard, laborer, house Cottage near Plymouth avenue [h. 1 Rome
 Rice Seligman (*I. Rice Sons*), 29 East Main,
 Rice Smith W. carpenter, house 59 Kirk
 Rice Solomon H. clerk, 5 E. Main, b. 11 Pitt
 Rice Thomas W. tillerman, hook and ladder No. 1, 61 Front, boards 10 Magne
 Rice Wallace, carpenter, house 10 Evergreen
 Rice Walter, laborer, bds. 58 Oakland park
 Rice Wilbur W. boxmaker, 111½ N. Water, boards 61 Savannah
 Rice William, farmer, h. Culver n. Norton
 Rice William H. sawyer, 100 S. St. Paul, boards 68 do.
 Rice William H. sawyer, h. 68 Mt. Hope av.
 Rice William N. boxmaker, h. 61 Savannah
 Rice & Wolff (*H. Rice and W. Wolff*), hats, caps, &c., 49 Mill
 Rice, see Reis and Ries
 Rich Giles B. boards 49 East avenue
 Rich John S. clerk, 51 Powers' bldgs. house at Washington
 Rich Lafayette, removed to Putnam, Conn.
 Rich Marvin, house 9 Bloss
 Rich Mary, widow, house 109 St. Joseph
 Rich Mary, widow, h. Monroe av. n. Culver
 Rich Samuel, deceased July, 1875 [S. Ford
 Rich Willard G. clerk, 29 W. Main, house 13
 Richard John L. boatbuilder, house 5 Cliff
 Richard Robert, laborer, house 11 Zimmer
 Richards Charles H. removed to Syracuse
 Richards Charles R. salesman, 4 Allen, bds. Whitcomb House
 Richards Henry, house 15 Frank
 Richards Jane R. widow, bds. 30 North av.
 Richards John, butcher, h. 15 Tonawanda
 Richards Joseph V. clerk, boards 2 Centre
 Richards Mary, widow, bds. Myrtle n. Lyell
 Richards Paul, shoemaker, 124 Front, house Wackerman n. Campbell
RICHARDS WILLIAM, carpenter and contractor, Myrtle near Lyell, house do. —*See page 635* [b. 66 Adams
 Richardson Albert, hairdresser, 34 Exchange, Centre, boards 36 Lyell
 Richardson Elizabeth, boarding house, 21 Elm
 Richardson Fannie L. teacher, bds. 21 Elm
 Richardson Frances, domestic, bds. Monroe avenue corner Wilcox
 Richardson Frank J. student, University of Rochester, boards 20 North av.
 Richardson Harriet L. widow, h. 43 Franklin
 Richardson Helen M. boards 49 S. Clinton
 Richardson Henry M. carriagemaker, foot Centre, boards 36 Lyell
 Richardson James, chairmaker, h. 114 Jones
 Richardson John, b. Hague n. W. Maple
 Richardson John A. carpenter, house 68 West avenue
 Richardson Kate Mrs. boards 29 William
 Richardson Kate Miss, boards 22 Manhattan
 Richardson Lorenzo H. (*Harrington & Richardson*), foot Centre, house 36 Lyell
 Richardson Sherman D. canvasser, house Hague near West Maple
 Richardson S. Brown, student, University of Rochester, boards 20 North
 Richardson William, miller, Granite Mills, Brown's race, b. 252 N. St. Paul
 Richardson William Mrs. house 25½ East av.
 Richardson Wm. A. painter, h. 29 William
 Richardson William H. Mrs. b. 22 Atkinson
 Richener Jacob, foreman, house 22 Cypress
 Richer Emma M. Mrs. house 47 South Ford
 Richmond Alice, milliner, 2 Elwood block, boards 137 Plymouth av.
 Richmond Daniel, civil engineer, R. W. W. City Hall, h. 137 Plymouth avenue
 Richmond Edward, wiper, boards 4 Adams
 Richmond Henry E. sheriff, Court House, boards National Hotel
 Richmond H. Addison, clerk, sheriff's office, boards 77 Monroe avenue
 Richmond James H. bookkeeper, Clarissa opp. Exchange, boards 149 Alexander
 Richmond Miriam F. teacher, Tremont School, No. 3, boards 12 Trowbridge
 Richmond Samuel C. fireman, Erie railway, boards 41 Edinburgh
 Richner Henry, laborer, h. Goodman n. Bay
 Richner Wm. fireman, 137 N. Water, house Third avenue near Bay
 Richter Charles, teamster, bds. 38 Galusha
 Richter Frank C. tailor, 93 South, h. h. do.
 Richter Henry, blacksmith, h. 10 Stepheny's park
 Richter Wm. carpenter, h. 172 Pinnacle av.
 Rickard Bernard T. laborer, b. 35 Romeyn
 Rickard Charles, jeweler, bds. 160 N. Clinton
 Rickard Elizabeth M. boards 90 Jay
 Rickard Frances, widow, house 5 Grove
 Rickard James, saloon, 57 Jay, house do.
 Rickard Joachim P. shoemaker, house 103 West Maple [35 Romeyn
 Rickard John, laborer, Platt cor. Kent, bds.
 Rickard Julia, widow, house 10 Julia
 Rickard Robert, laborer, Kent corner Platt, house 35 Romeyn
 Rickard Thomas, removed to Buffalo
 Rickarts Charles W. watchmaker, 104 North Clinton, boards 160 do.
 Ricker John F. tinsmith, 48 Exchange, house at Irondequoit
 Ricker Wentworth G. machinist, Mill corner Platt house 132 Mt. Hope avenue
 Rickert John, carman, house 21 Holland
 Rickert Mary, tailoress, boards 21 Holland
 Rickett Thomas, removed from city
 Riddle George B. expressman, h. 5 Caroline
 Riddle Robert, laborer, h. Mansion c. Flint
 Riddle Rosa, widow, house r. 91 Tremont

- Ridel Adam, baker, 141 North Water, house
Lincoln near landing
- Rideout Catharine, widow, house 31 Cole
- Rideout Catharine, tailoress, boards 31 Cole
- Rideout Luke, barber, boards 31 Cole
- Rider Chas. E. physician, 60 Fitzhugh, h. do.
- Rider Edward A. blacksmith, bds. 58 Kent
- Rider, John H. teamster, house 36 Champlain
- Rider, see Ryder
- Ridgway Charles W. student, University of
Rochester, boards 4 Stillson
- Ridley Benjamin F. carpenter, h. 77 William
- Ridley William H. clerk, 52 East Main, bds.
77 William
- Riebel Andrew, tailor, house 79 Cady
- Riebel John N. hairdresser, boards 79 Cady
- Riedel John, blacksmith, boards 53 Scio
- Riedesel John, woodworker, bds. N. Clinton
near avenue A [b. 171 N. St. Paul
- Riedinger Frederick, laborer, 139 N. St. Paul,
- Rieger Charles, tailor, house 10 Chatham
- Riegler George, nurseryman, h. 61 Lincoln
- Riehr Christopher, deceased April, 1875
- Riehr Theresa, house 139 St. Joseph
- Ries Geo. J. blacksmith, 3 Canal, h. 77 Childs
- Ries John, grocer, Childs cor. Jay, house do.
- Ries John M. policeman, City Hall, boards
Childs corner Jay
- Ries Peter, helper, 3 Canal, bds. 14 Canal
- Riesenacker John, upholsterer, 69 N. St. Paul,
house 153 St. Joseph
- Rigali Paul, moulder, 4 College av. house
252 East Main
- Riggs Helen, domestic, boards 262 State
- Riggs Herman S. pastor, St. Peter's church,
boards 41 South Union
- Riggs Lewis, whipmaker, Allen c. N. Wash-
ington, bds. 14 Favor
- Rigley, see Wrigley
- Rigney Bridget, widow, house 13 Otsego
- Rigney Catharine, dressmaker, 20 N. St. Paul,
house do. [Main
- Rigney Edward F. bookkeeper, h. 218 West
- Rigney James, polisher, 126 State, b. 13 Otsego
- Rigney John J. cigarmaker, 57 State, boards
Reed House
- Rigney Margaret X. boards 28 Phelps avenue
- Rigney Mary A. I. domestic, bds. 13 Otsego
- Rigney Matthew, house 70 Lyell
- Rigney William J. receiver, st. railroad, 159
State, boards 20 N. St. Paul
- Riley Albert A. marble mantels, 123 West
Main, boards 21 Sophia
- Riley Alvin, printer, boards 27 Kirk
- Riley Annie Miss, boards 31 N. St. Paul
- Riley Ashbel W. house 72 South St. Paul
- Riley Bernard B. shoemaker, 73 N. Water,
boards 82 Atwater
- Riley Charles, laborer, house 2 Kent alley
- Riley Charles jr. varnisher, bds. 2 Kent alley
- Riley Charles, gardener, h. r. Jay near James
- Riley Eliza, widow, house 133 N. St. Paul
- Riley George S. farmer, house 72 S. St. Paul
- Riley James, telegraph repairer, 11 Arcade,
boards 6 Tonawanda
- Riley James, clerk, 144 N. St. Paul, bds. do.
- Riley James, laborer, house 10 Terry
- Riley James, laborer, house 37 Delevan
- Riley James, car coupler, N. Y. C. R. R.
depot, h. 47 Hand [7 University av.
- Riley James C. chairmaker, 184 State, house
- Riley James C. jr. carver, Hydraulic bldgs.
boards 7 University avenue
- Riley John, teamster, 134 Oak, h. 11 Moore
- Riley John, cigarmaker, boards 37 Joiner
- Riley Martin, telegraph repairer, 11 Arcade,
house 6 Tonawanda
- Riley Mary, house 11 Ward
- Riley Mary, widow, house 218 West Main
- Riley Mary A. milliner, boards 2 Kent alley
- Riley Michael, shoemaker, 77 North Water,
boards 28 Joiner
- Riley Philip, engineer, house 14 Oregon
- Riley Thomas, fireman, N. Y. C. R. R. h.
63 Nassau [7 University av.
- Riley William H. upholsterer, 184 State, bds.
- Riley, see O'Riley and O'Reilly
- Rilley Jane, domestic, bds. 135 Alexander
- Rilley Jane, widow, house 28 Chatham
- Rimes Anna E. widow, house 116 North av.
- Rinck George, shoemaker, 75 North Water,
house 112 Jay
- Rinehart John, laborer, house 21 Caroline
- Rineys Michael, laborer, b. 198 Alexander
- Ring Bernard, tailor, 49 Front, bds. 45 Kent
- Ring Slot, widow, house 67 Herman
- Ringfeil Louis, blacksmith, h. 17 Philander
- Ringlan Ann, widow, house 39 Platt
- Ringle Jane, widow, house 195 Monroe av.
- Ringlestein Augustus G. saloon, 29 Front,
house do.
- Ringlestein Jacob, boards 34 Front
- Ringlestein Joseph, saloon, 20 Exchange
place, house do.
- Ringwood John, grocer, 118 Adams, h. do.
- Ringwood Mary, dressmaker, bds. 2 Lorimer
- Rinhart Adam, milkman, h. Mt. Hope av. n.
tollgate
- Rinker Charles, baker, house 135 N. Union
- Rinn Francis, laborer, h. 103 Caledonia av.
- Rinzland Henry, grinder, house 107 Wilder
- Rippin Joseph, blacksmith, 117 N. Water,
house 84 North av. [Water, h. 45 Pearl
- Ripsam Augustus, mouldingmaker, 43 N.
- Ripsom Ann M. widow, house 53 Charlotte
- Ripsom George E. lawyer, 81 Powers' bldgs.
house 25 Prince
- Ripsom Lucinda, widow, house 25 Prince
- Ripsom Richard, cooper, bds. 53 Charlotte
- Ripson John, house 247 Exchange
- Ripson John jr. carver, boards 247 Exchange
- Ripson Mary, widow, boards 22 Frost avenue
- Ripson Philip L. printer, 82 W. Main, b. 247
Exchange
- Rising Benj. miller, Ely Mills, b. 12 N. Water
- Risser Matthias, plasterer, house 44 Hoeltzer
- Ristow Augusta, bds. East av. c. Alexander
- Ritchle Lucas, farmer, h. Carter n. Norton
- Rith Fridolin, shoemaker, 32 Herman, b. do.
- Ritt Albert W. blacksmith, bds. 6 Rauber
- Ritt Hugh, blacksmith, 245 E. Main, boards
6 Rauber [Rauber
- Ritt John, blacksmith, 245 E. Main, house 6
- Ritter Charles, upholsterer, 73 State, boards
6 Almira
- Ritter Elizabeth, widow, house 95 Frances

Ritter Ernest Wm. harnessmaker, ft. Rowe, house 54 Munger [b. 135 N. Clinton
 Ritter Frank, cabinetmaker, 117 N. Water,
 Ritter Franklin, dep. sheriff, Court House, h. 18 Arnold park [Frances
 Ritter Geo. M. cutter, 79 North Water, b. 95
 Ritter Henry L. stonemason, 22 West avenue, boards 95 Frances
 Ritter Johanna, widow, house 6 Almira
 Ritter Lawrence, cabinetmaker, 117 North Water, house 15 Hawkins
 Ritter Peter, pastor First German Baptist Church, Andrews st. house 76 Asylum
 Ritter Philip, cork cutter, 205 Plymouth av. boards 36 Tremont [Oakland park
 Ritter William, carpenter, 10 S. Water, h. 27
 Ritter William, cutter, 64 Mill, house 16 Cole
 Ritter William G. carpenter, 147 W. Main, house 3 Davis
 Rittersbacher Martin P. laborer, h. 44 Wilder
 Ritz Adam, laborer, house 11 Huron
 Ritz Caspar, carpenter, h. Huron n. Hebard
 Ritz Charles, teamster, h. Bond near Grand
 Ritz Charles J. hairdresser, 1 Corinthian Hall building, h. 278 State
 Ritz Ferdinand, grocer, 91 N. Clinton, b. do.
 Ritz Franklin, coupler, N. Y. C. R. R. h. 178 Scio [43 Gibbs
 Ritz Frederick, butcher, 149 E. Main, house
 Ritz George, tobacco cutter, 55 S. St. Paul, h. Huron cor. Hebard
 Ritz John M. switchman, house 3 Philander
 Ritz Joseph, shoemaker, Monroe av. cor. Marshall, house Cayuga place [Scio
 Ritz Joseph, butcher, 114 E. Main, bds. 60
 Ritz Leonard, foreman, h. 1 Cayuga place
 Ritz Mary A. widow, house 20 Buchan park
 Ritz, see Rehtz
 Ritzenthaler Bernard, carver, house 51 Colvin
 Ritzenthaler John, laborer, h. Ames n. R. R.
 Rivard Frank, shoemaker, 22 Johnston's blk. house 48 Atwater [b. 48 Atwater
 Rivard Peter, shoemaker, 22 Johnston's blk.
 Rivers Edward, shoemaker, 111 State, house 42 Tyler [Lyell n. tollgate
 Rivers Edward A. 13 Warehouse n. Platt, h.
 Rivers Louis, brakeman, house 51 Davis
 Rivers Solomon, laborer, house 8 Zimmer
 Rixham John F. grinder, 136 Mill, boards 39 West Maple
 Roach Catharine, housekeeper, 7 South
 Roach David, laborer, house 123 Hudson
 Roach Martin, laborer, h. 82 South avenue
 Roach Thomas W. shoemaker, b. 154 State
 Roach, see Roche [29 Atkinson
 Roades Fred. B. clerk, 16 State, boards
 Roades George H. clerk, 38 W. Main, b. 54 Atkinson [house 29 Atkinson
 Roades William, boots and shoes, 38 W. Main,
 Roark Edward H., Hook and Ladder No. 1, 61 Front, boards do.
 Robach Morris J. teamster, h. 57 Monroe av.
 Robb James, removed to Holley
 Robb John, house 33 Kent
 Robb Joseph E. deceased, 1876
 Robb Lorn, coachman, house 9 East park
 Robb William R. carpenter, house 8 North Washington

Robbin Frederick, engraver, h. 42 Lowell
 Robbins Amos D. machinist, Brown c. Jones, house 62 Brown [62 Brown
 Robbins Andrew J. engineer, S. L. R. R. h.
 Robbins De Garmo, removed to Chicago, Ill.
 Robbins Edward W. moulder, 8 Hill, house 6 Bauer [h. 98 Mt. Hope avenue
 Robbins Geo. C. bookkeeper, 36 Exchange,
 Robbins G. Homer, compositor, bds. 11 Saratoga avenue [Plymouth av. b. 48 do.
 Robbins Joseph W. (J. E. Spencer & Co.), 21
 Robbins Mosley F. salesman, 53 E. Main, b. 96 Mt. Hope avenue
 Robbins Sarah S. widow, b. 98 Mt. Hope av.
 Robbins, see Robins
 Robertine Sister, teacher, bds. Jay c. Frank
 Roberts Albert, clerk, 4 W. Main, boards 11 Monroe avenue [Bay
 Roberts Alvord, engineer, h. German al. n.
 Roberts Benjamin T. Rev. editor Earnest Christian, 87 State, house at N. Chili
 Roberts Benjamin W. photographer, 108 State, house do. [S. Water, h. 10 George
 Roberts Christopher F. (James Wilson & Co.),
 Roberts Disa, widow, boards 103 Lake av.
 Roberts Edwin P. removed to Michigan
 Roberts Eleaza B. boiler maker, house 5 German alley
 Roberts Eliza L. widow, h. 11 Greenwood av.
 Roberts Eugene, teamster, h. r. 29 Broadway
ROBERTS G. HENRY, manager Traders' Insurance Co., 6 Elwood blk. boards 6 Franklin square.—See inside front cover
 Roberts Hattie I. music teacher, boards 11 Greenwood av. [roe av. n. Goodman
 Roberts Henry, mason, 54 Fitzhugh, h. Mon-
 Roberts Henry C. & Co. (A. S. Clarke), coal, 17 Powers' bldgs. house 220 Exchange
 Roberts Jane A. Mrs. house 5 Clarissa
 Roberts John, photographer, 108 State, house at Poughkeepsie [3 Bond
 Roberts John C. shoemaker, 111 State, house
 Roberts John S. painter, 9 Division, house 92 Broadway
 Roberts J. Wilber, bookkeeper, Fitzhugh c. Erie canal, h. 147 Fitzhugh
 Roberts Lura, widow, boards 7 Clinton pl.
 Roberts L. Elbert, clerk, 124 E. Main, bds. 84 East avenue
 Roberts Marion, cooper, house 4 Fullam's pk.
 Roberts Mary L. widow, house 65 Allen
 Roberts Millie, widow, boards 38 Atwater
 Roberts M. Alice, widow, b. 16 Edinburgh
 Roberts Nathan, foreman, 4 Griffith, house 58 Munger
 Roberts Nettie Mrs. boards 89 East avenue
 Roberts Sarah, widow, house 2 German
 Roberts Sarah E. Mrs. clerk, 130 State, b. do.
 Robertson Arthur B. bookkeeper, 89 North Water, boards 134 N. Clinton
 Robertson Hannah, widow, b. 18 Charlotte
 Robertson James, coachman, house Bismarck near Genesee
 Robertson James L. pastor First Presbyterian Church, house 39 Plymouth avenue
 Robertson John, removed from city
 Robertson Sarah A. dressmaker, 134 North Clinton, house do.

Robins Egbert B. engineer, h. 11 Woodbury
 Robins Emmett C. fireman, N. Y. C. R. R. boards 11 Woodbury
 Robins Johnson I. jr. (*A. J. Johnson & Co.*), 4 Allen, boards 58 Sophia
 Robins Johnson I. & Son (*S. P. Robins*), painters, 10 Front, house 58 Sophia
 Robins Lucy, widow, house 23 Clarissa
 Robins Sylvester P. (*J. I. Robins & Son*), and (*Robins & Waite*), house 7. Frank
 Robins & Waite (*S. P. Robins and I. D. Waite*), sash manufs., Aqueduct n. canal
 Robins see Robbins
 Robinson Alanson D. painter, h. 17 Comfort
 Robinson Alice A. teacher, Andrew School, No. 9, boards 13 Pleasant
 Robinson Arthur, 15 Exchange, house 25 S. Washington [California
 Robinson Benjamin P. removed to Oakland
 Robinson Bridget, boards 50 Frank
 Robinson Bros. (*S. G. and J. B. Robinson*), carpenters, 33 King
 Robinson Charles, chair manufacturer, 15 Warehouse, house 69 Lake avenue
 Robinson Chas. E. carpenter, b. 41 Savannah
 Robinson Chas. F. carpenter, h. 41 Savannah
 Robinson Chas. J. (*Brown & Robinson*), 30 Canal, boards 9 White [17 Frank
 Robinson Charles J. salesman, 118 Front, b.
 Robinson Cyrus B. (*O. and C. B. Robinson*), 123 State [Concord av.
 Robinson Elizabeth M. Miss, boards 6
 Robinson Emma M. widow, house 6 Gibbs
 Robinson Evans, physician, 6 Concord av. house do. [bldgs. b. 23 Jones
 Robinson Frank C. student, 133 Powers'
 Robinson Franklin E. rem'd to Brooklyn, L.I.
 Robinson Frederick, boards 17 Comfort
 Robinson Frederick B. shoecutter, house 59 William
 Robinson George C. carpenter, h. 155 Jay
 Robinson Helen A. Miss, teacher, Atwater School, No. 10, b. 23 Jones [Frank
 Robinson Homer G. music teacher, house 98
 Robinson Hugh, carman, house 114 Frank
 Robinson James, house Genesee n. Hunter
 Robinson James, removed to Montreal, Can.
 Robinson James, laborer, h. Pinnacle av. n. Henrietta avenue
 Robinson James, whitewasher, house 76 Broadway [17 Frank
 Robinson James A. expressman, 83 State, b.
 Robinson James A. blacksmith, 14 Market, house 167 North Clinton
 Robinson James H. agent, bds. 52 North av.
 Robinson John Mrs. house 52 North avenue
 Robinson John D. builder, h. 3 New York
 Robinson John T. carpenter, Minerva alley, house 57 Weld [King, h. do.
 Robinson Joseph B. (*Robinson Bros.*), 33
 Robinson Julia II. Miss, music teacher, bds. 98 Frank
 Robinson J. Sanford, removed from city
 Robinson Lewis, hostler, Whitcomb House, boards do.
 Robinson Martha, widow, house St. Clair
 Robinson Martha H. Miss, b. St. Clair near Clifton

Robinson Oliver & C. B. bedstead manufacturers, 123 State, house 23 Jones
 Robinson Otis H. professor University of Rochester, house 75 North Union
 Robinson Reginald D. bookkeeper, 116 Mill, boards 3 New York
 Robinson Samuel G. (*Robinson Bros.*), 33 King, h. 33 St. Clair near Clifton
 Robinson Samuel J. teamster, h. 151 South avenue
 Robinson Sarah, widow, bds. 22 Fulton av.
 Robinson Sherman R. lawyer and insurance agent, 85 Powers' bldgs. h. 54 S. Ford
 Robinson William, waiter, Osburn House
ROBINSON WILLIAM, gravel roofing, 48 Exchange, house 8 W. Troup.—See page 642
 Robinson William H. carpenter, boards 41 Savannah [h. 24 Fulton av.
 Robinson William H. agent, 42 State,
 Robinson William J. dyer, 77 South St. Paul, house do. [114 Frank
 Robinson William J. carpenter, boards
ROBY SIDNEY B. & CO. (*H. W. Cary*), saddlery, hardware, iron steel, &c., 80 State and 41 Mill and (*Wm. Corris & Co.*), house 40 Spring.—See page 607
 Roby Sidney J. salesman, 80 State, boards 40 Spring [N. Clinton
 Roch Jules, locksmith, 7 Andrews, house 273
 Roche Charles A. boards 29 Lyell
 Roche Daniel E. bookkeeper, bds. 143 Lyell
 Roche Edward F. machinist, bds. 29 Lyell
 Roche Elizabeth, widow, house 94 Pearl
 Roche John, gardener, house 101 Adams
 Roche John, shoemaker, 27 Walbridge's blk. house 29 Lyell [near Jay
 Roche John H. cabinetmaker, h. Wackerman
 Roche John M. wood moulder, 133 N. Water, house 61½ St. Joseph
 Roche Margaret Mrs. house 9 Julia
 Roche Patrick T. boards 30 Smith
 Roche Rosa M. widow, house 143 Lyell
 Roche, see Roach [h. 66 Caledonia av.
 Rochester Henry E. collector at weigh lock,
 Rochester Jennie, young ladies' school, 66 Caledonia avenue, boards do.
ROCHESTER JOHN H. secretary Mechanics' Savings Bank, 15 Exchange, h. 16 South Washington.—See page 498
 Rochester Nathaniel T. b. 9 S. Washington
 Rochester Thomas M. student, University of Rochester, bds. 16 S. Washington
ROCHESTER ADAMANTINE BRICK **R**U CO. 5 Masonic block.—See page 638
ROCHESTER AGRICULT'L WORKS, **R**U 100 South St. Paul.—See page 675
ROCHESTER AXLE CO. 154 N. Water, **R**U—See page 608
ROCHESTER BOOT MANUFACT'G CO. **R**U 81 North Water.—See page 664
 Rochester Bracket Works, 22 East Main
ROCHESTER BREWING COMPANY, **R**U foot of Cliff.—See page 562
ROCHESTER BRICK & TILE MANUF. **R**U CO. 51 Powers' bldgs.—See page 638
 Rochester City Hospital West avenue
 Rochester Cotton Mill, foot of Centre

ROCHESTER DIRECTORY OFFICE, 114 Powers' bldgs.—*See front colored page*
 Rochester Driving Park Association, 3 Smith's block
ROCHESTER FREAR STONE CO. Mt. Hope avenue, foot of Hamilton place.—*See page 650*
 Rochester Free Dispensary, 61 Front
ROCHESTER GAS LIGHT CO. Mumford near bridge.—*See page 492*
ROCHESTER GERMAN INSURANCE CO. Roch. Savings Bank bldg. W. Main corner Fitzhugh.—*See page 691*
 Rochester Home of Industry, 136 S. St. Paul
ROCHESTER INSOLE MANUF. CO. 75 North Water.—*See page 667*
 Rochester Iron Manuf. Company, 33 Mill
ROCHESTER MACHINE SCREW CO. Mill cor. Furnace.—*See page 677*
 Rochester Opera House, 11 South St. Paul
 Rochester Orphan Asylum, Hubbell park
ROCHESTER PAPER CO. A. M. Hastings, prest. at lower falls.—*See page 521*
ROCHESTER PLATING WORKS, silver and nickel plating, 122 Mill.—*See p. 670*
ROCHESTER PRINTING CO. publishers Democrat and Chronicle, 3 West Main.—*See opp. page 531*
ROCHESTER SAVINGS BANK, West Main cor. Fitzhugh.—*See page 496*
 Rochester Soap Works, 55 Front
 Rochester Theological Seminary, East av. corner Alexander [Clifford]
 Rochester Wood Pulp Co. North St. Paul n.
 Rochlein Frederick, laborer, h. 128 Meigs
 Rock James, tailor, 62 Smith's block, house 24 Hand [24 Hand]
 Rock James jr. tailor, 62 Smith's block, bds.
 Rock Michael T. clerk, 131 State, b. 24 Hand
 Rockett Ellen, widow, house 7 Hand
 Rockett Michael, tinsmith, 144 East Main, h. 9 Gorham [7 Hand]
 Rockett Thomas H. tinsmith, 144 E. Main, b.
 Rockfellow Edwin L. carriage trimmer, 1 Lancaster, house 33 Lancaster
 Rockfellow John A. student, Rochester University, boards 41 Frank
 Rockfellow Samuel L. real estate and (*E. S. Lee & Co.*), 19 Warehouse, h. 41 Frank
 Rockwell Ashbel S. physician, 2 Washington Hall bldg. [N. St. Paul]
 Rockwell Edward, teamster, bds. Cataract n.
 Rockwell George R. boatman, b. 10 Marion
 Rockwell Mary, widow, house 31 Alexander
 Rockwell Victoria, music teacher, boards 31 Alexander
 Rockwell Wm. D. machinist, b. 10 Marion
 Rockwood Mary L. widow, house 95 Lyell
 Roda Adolph, carver, River near North St. Paul, house 115 N. St. Paul
 Roda Cornelius, grainer, 14 Stone, house 2 Bismarc place [h. 46 Chatham]
 Roda John, cabinetmaker, Jay c. Erie canal,
 Roda John, laborer, house Henrietta av. n. Pinnacle avenue [Chatham]
 Roda John jr. clerk, 87 East Main, boards 46
 Roda Mary, dressmaker, bds. 46 Chatham
 Roda William, deceased November, 1875

Rodell Annette M. widow, h. 2 Chestnut pk.
 Rodell Eugene F. printer, 17 Masonic block, boards 2 Chestnut pk. [h. 3 Mathews]
 Rodell Frank W. printer, 17 Masonic block,
 Rodell Henry, marble cutter, b. 12 Litchfield
 Roden John, laborer, house Oak n. Smith
 Rodenbeck Adolph & W. grocers, 37 North avenue, house do.
 Rodenbeck Elizabeth, widow, b. 37 North av.
 Rodenbeck Frederika C. Mrs. stoves, tinware, &c. 13 South av. house 4 Pinnacle av.
 Rodenbeck William (*A. & W. Rodenbeck*), h. 37 North avenue [boards do.]
 Roderick Clarence, waiter, Clinton Hotel,
 Roderick Emma, music teacher, boards 35 Fitzhugh [change, h. do.]
 Roderick James R. boarding house, 84 Ex-Rodgers Joseph P. saloon, 40 N. Water, h. do.
 Rodman John, cabinetmaker, River n. North St. Paul, house 29 Hoeltzer
 Rodman Lewis, teamster, h. Brighton avenue near Pinnacle avenue
 Roe Israel, salesman, 73 East Main, house 1 Edmonds [Bolivar]
 Roe James A. painter, 9. W. Main, boards 36
 Roe John, sawyer, boards 36 Bolivar
 Roe John A. carpenter, house Hudson near Bernard [11 George]
 Roe John E. lawyer, 19 Powers' bldgs. bds.
 Roe John O. physician, 8 Washington Hall block, boards Whitcomb House
 Roe Joseph, foreman, Brown's race n. Furnace, house 38 Jay [Cypress]
 Roe Joseph E. salesman, 15 E. Main, bds. 54
 Roe Joseph F. h. 36 Bolivar [Bolivar]
 Roe Richard M. baker, 45 Fitzhugh, bds. 36
 Roe Roland B. farmer, house Goodman near Jennings
 Roe Ruth, wax flowers, h. 73 South Union
 Roedel Ernst, tailor, house 28 Cole
 Roehm George J. cabinetmaker, 123 Mill, h. Maria near Clifford [house 47 Vienna]
 Roeker Frederick, carpenter, 14 St. Joseph,
 Roeser August, filecutter, River cor. North Water, house 19 Hope [28½ Joiner]
 Roesch Frederick, weaver, 44 Exchange, h.
 Roesser Caspar, mason, house Alphonse near Hudson
 Roesser John, removed to Penfield
 Roesser Joseph, hairdresser, 235 State, b. do.
 Rogan Bridget, widow, house 45 Lyell
 Rogan Wm. E. clerk, 64 State, h. 3 Denning
 Rogers Albert J. smoother, 38 Gorham, house 70 Lowell
 Rogers Albert M. boat captain, h. 55 S. Union
 Rogers Albert W. clerk, 104 W. Main, bds. 24 Glasgow
 Rogers Ambrose, house 70 Kent [Ward]
 Rogers Barnett, shoemaker, 14 State, bds. 2
 Rogers Bella, teacher, boards 2 Marietta
 Rogers Bernard, shoemaker, boards 2 Ward
 Rogers Bernard D. cutter, 44 Mill, h. 34 Hand
 Rogers Bethania, widow, boards 15 Tappan
 Rogers Catharine, paper boxmaker, house 70 Lowell
 Rogers Charles, laborer, b. Scio near R. R.
 Rogers Clinton (*Howe & Rogers*), 37 State, b. 5 South Washington

- Rogers Eliza J. teacher, Oakman School, No. 20, boards 2 Marietta
- Rogers E. Henry, laborer, boards 9 Jay
- Rogers Fernando E. (*Williams & Rogers*), W. Main c. Exchange, b. 10 Jones avenue
- Rogers Frank, clerk, 128 East av. boards do.
- Rogers Frederick D. printer, 82 West Main, house 2 Marietta [house 96 Adams
- Rogers Fred S. bookkeeper, 17 West Main,
- Rogers George G. veterinary surgeon, Monroe avenue near Erie canal, house do.
- Rogers George W. clerk, Bank of Rochester, 41 State, house 18 Eagle [East av.
- Rogers Harry D. clerk, 53 East Main, bds. 9
- Rogers Henry E. nurseryman, b. 25 Munger
- Rogers Henry M. watchman, 73 East Main, house Champlain near Genesee
- Rogers Henry M. removed to Springwater
- Rogers Henry T. sec'y and treas. Roch. Gaslight Co., Mumford n. bridge, house 21 Troup [rapids
- Rogers Hiram, constable, h. tow path at
- Rogers Irvin H. student, University of Roch. boards 6 Charlotte [9, b. 2 Marietta
- Rogers Isabella, teacher, Andrews school, No.
- Rogers James, coachman, 2 Prince, bds. do.
- Rogers Jas. W. painter, 3 Canal, h. 36 Prospect
- Rogers James W. silver plater, b. 50 Tappan
- Rogers John S. laborer, house 78 Court
- Rogers Joseph H. machinist, Brown's race n. Furnace, b. 14 George
- Rogers J. Guilford, teamster, h. Scottsville road near Rapids [change, h. 31 Troup
- Rogers Lafayette (*Rogers & Converse*), 14 Exchange
- Rogers Lawrence, shoemaker, 83 N. Water, boards 2 Ward [N. Water, house do.
- Rogers Mary Mrs. boarding, Mortimer cor.
- Rogers Mary A. Miss, house 81 William
- Rogers Mary C. boards East av. c. Alexander
- Rogers Mary G. widow, boards 11 Comfort
- Rogers Michael, groom, b. r. 147 East Main
- Rogers Patrick, shoemaker, 14 State, house 2 Ward
- Rogers Patrick, shoemaker, 73 North Water, house South avenue cor. Pinnacle av.
- Rogers Patrick, gardener, bds. Fairmount near University avenue [Ward
- Rogers Peter, shoemaker, 83 N. Water, b. 2
- Rogers Rebecca, dressmaker, 78 Court, h. do.
- Rogers Rose, widow, house 25 Munger
- Rogers Sabina C. widow, house 49 Oak
- Rogers Simon W. leather dresser, house 71 South Union
- Rogers Stephen, hay, boards 1 Jones
- Rogers Stephen J. (*Bingham, Bemis & Rogers*), 57 State, house 1 Jones
- Rogers Thomas, shoemaker, boards 78 Court
- Rogers Thomas, laborer, h. Mansion n. Flint
- Rogers Thomas, h. 33 South Washington
- Rogers Thomas H. draftsman, water works, City Hall, boards 21 Troup
- Rogers Varnum M. engineer, Erie railway, house 211 Exchange
- Rogers William, health officer, h. 50 Tappan
- Rogers William jr. clerk, 148 State, bds. 50 Tappan
- Rogers William A. agent, h. 136 Plymouth av.
- Rogers Wm. B. machine agent, h. 40 Allen
- Rogers William H. house 33 S. Washington
- Rogers William H. H. bookkeeper, 51 Powers' bldgs. boards Clinton Hotel
- Rogers William Jerome, detective, City Hall, house 1 Jones
- ROGERS & CONVERSE** (*L. Rogers and C. T. Converse*), carpets, oil cloths, &c., 14 Exchange.—See page 597
- Roggman John, peddler, h. Miller near Bay
- Rohde Christopher, shoemaker, 66 Nassau, house do.
- Rohde Fred, peddler, house 13 Henry
- Rohde Henry J. shoemaker, h. 44 Thomas
- Rohde John, cabinetmaker, 74 State, house 8 Rhine
- Rohen Patrick, laborer, h. Huron c. Hebard
- Rohr Abraham, varnisher, 73 State, b. Rohr near Bay
- Rohr Annie Miss, seamstress, b. 54 Ontario
- Rohr Benj. B. carpenter, 100 S. St. Paul, b. 138 Scio
- Rohr Edward, carpenter, boards 138 Scio
- Rohr Elizabeth, widow, house 54 Ontario
- Rohr Henry, house 72 Tappan
- Rohr Henry, moulder, 8 Hill, h. 138 Scio
- Rohr Jacob, tailor, boards 43 Gregory
- Rohr Jerome, carpenter, boards 54 Ontario
- Rohr John, clerk, 35 Scio, boards 160 North
- Rohr John, moulder, 8 Hill, house 140 Scio
- Rohr John, painter, 73 State, h. 5 Marietta
- Rohr John B. marblecutter, 166 State, bds. 140 Scio
- Rohr John H. varnisher, 73 State, house 90 North avenue
- Rohr John R. Mrs. widow, h. 160 North av.
- Rohr J. Rudolph, varnisher, h. Bay c. Rohr
- Rohr Magdalena, widow, boards 35 Wilder
- Rohr Mary, widow, house Rohr near Bay
- Rohr Renemus, carpenter, boards 54 Ontario
- Rohr Robert R. moulder, 8 Hill, b. 140 Scio
- Rohr Rudolph, carpenter, house 4 Hollister
- Rohr Rudolph, carpenter, house 63 German
- Rohr Samuel, tailor, house 43 Gregory
- Rohr Sebastian, laborer, house r. 74 Weld
- Rohr William, tinsmith, house 138 Scio
- Rohrbach Morris, deliverer, h. 63 Monroe av.
- Rohrbacher Anna M. dressmaker, 217 North Clinton house do. [Clinton, house do.
- Rohrbacher Charles, fancy goods, 217 North
- Rohrbacher Henry, removed to Buffalo
- Roland Edward, moulder, Brown's race near Furnace, house 102 St. Joseph
- Roland Mary M. widow, h. 149 South av.
- Rollans Benson, laborer, bds. 198 Alexander
- Rolfe Barbara, widow, house 64 Kirk
- Rolfe Charles, sashmaker, Aqueduct, boards 64 Kirk
- Rolfe John, laborer, house 86 Pearl
- Roll Christina, widow, boards 38 Sellinger
- Roller Jacob, cabinetmaker, 184 State, house 72 Kelly [house do.
- Rollett T. Wilfred, hostler, r. 118 W. Main,
- Roloff John, cabinetmaker, 87 Exchange, boards 7 Bay
- Roloff Joseph, laborer, house 7 Bay
- Rolston Mary J. dressmaker, 23 Chatham, boards do. [Grand, h. do.
- Romeiser Bernard, laborer, Pinnacle av. near

- Romig Frank, brakeman, Erie Railway, bds. 164 Exchange [18 Bond, b. do.]
 Rommel Christopher jr. (*C. & C. Rommel jr.*),
 Rommel Christopher & C. jr., market, 18 Bond, boards do.
 Rommel Christopher 2d, cigarmaker, house 5 Whalin [18 Bond]
 Rommel Christopher J. carpenter, boards
 Ronan Patrick, teamster, h. 15 Vincent place
 Ronan Thomas, machinist, h. 1 Warehouse
 Roo Peter, grinder, house 13 Pryor
 Roodenburg Arend, shoemaker, 87 N. Water, b. 13 Emmett [b. 13 Emmett]
 Roodenburg Charles J. bookkeeper, 69 State,
 Roodenburg John C. ivory turner, 40 East Main, house 13 Emmett
 Roodenburgh Cornelius, turner, 3 Elizabeth, boards 28 Gorham
 Roof Henry, laborer, b. 88 Pearl [Spring
 Rooney James, blacksmith, 9 Ely, house 60
 Rooney Patrick, house 11 Charles [Lyll
 Rooney Sarah Mrs. house Brown's alley, n.
 Rooney William, removed from city
 Roos Louis, shoemaker, 37 Baden, house do.
 Roos Valentine, carpenter, house 53 Hanover
 Root E. E. salesman, 31 Exchange, h. Bergen
 Root Jason, agent, house 106 Genesee
 Ropelt John, piano maker, 4 Hill, house 45 Oakman
 Roper August, filecutter, house 19 Hope
 Roper Frederic, removed from city
 Rosch Joseph, bartender, 136 W. Main, b. do.
 Roschenbach Henry, shoemaker, 270 State, house Jay near Ames
 Rose Anna Mrs. cigarmaker, 218 W. Main, house do. [Prospect
 Rose Byron H. agent, 21 West Main, bds. 52
 Rose Charles O. cornices, 149 N. Water, h. 34 Caroline [bds. 3 South
 Rose Ezra, engineer, 122 South St. Paul,
 Rose Henry G. C. physician, 96 State, h. do.
 Rose Horace C. painter, house 10 Chestnut
 Rose Jane, widow, house 52 Prospect
 Rose Mary, teacher, bds. Jay cor. Frank
 Rose Samuel A. expressman, 35 Exchange, boards 148 Fitzhugh
 Roseau Mary, waiter, Whitcomb House, b. do.
 Rosecrans Jacob, laborer, h. 65 Monroe av.
 Rosecrants Edgar H. removed to Greece
 Rosecrants Harvey, liquors, 124 State, house 174 do. [Henry n. Clifford
 Rosen Charles, blacksmith, 161 North av. h.
 Rosenback Moses S. bookkeeper, 54 Mill, b. 71 N. Clinton
 Rosenbauer Charles, removed to Chicago, Ill.
 Rosenbauer Clemens, tailor, 47 Hanover, house do.
 Rosenbauer Wm. tailor, 47 Hanover, b. do.
 Rosenbaum Isaac, peddler, house 32 Vienna
 Rosenbaum Joseph, peddler, bds. 40 Joiner
 Rosenberg David (*H. & D. Rosenberg*), 11 State, house 58 North St. Paul
 Rosenberg George, salesman, Mill c. Mumford, house 11 Leopold [house 2 Pearl
 Rosenberg Henry L. C. artist, 12 East Main,
ROSENBERG HENRY & D. watches, jewelry and silverware, 11 State, house 55 Andrews.—*See page 515*
- Rosenberg Hermann (*Kolb, Rosenberg & Co.*),
 Mumford cor. Mill, house 3 Clinton place
 Rosenberg Sander, peddler, h. 58 St. Joseph
 Rosenberg Saul, peddler, h. 100 St. Joseph
 Rosenberg Sigmund, peddler, h. 53 Nassau
 Rosenberger Joseph, baker, 45 N. Clinton, house do.
 Rosenblat Catharine M. seamstress, bds. 62 Saxton [Saxton
 Rosenblatt Laurence F. chairmaker, bds. 62
 Rosenblatt Samuel, furnaces, ranges &c. 29 Exchange, house 33 Clinton place
 Rosenblum Jacob, peddler, h. 45 St. Joseph
 Rosenblum Max, peddler, house 25 Joiner
 Rosenfield Fanny, widow, bds. 47 Chatham
 Rosenfield Nimrod, rectifier, 7 Atwater, h. 31 Clinton place
 Rosengreen William J. stovemounter, house 42 Strong [Catharine
 Rosenhagen Albert, shoemaker, 4 Allen, h. 26
 Rosenstrauss Herman, house 17 Atwater
 Rosenthal Benjamin, house 27 Clinton place
 Rosenthal, Cauffman & Co. (*J. W. Rosenthal, J. Cauffman and M. Mock*), clothing, 72 Mill
R **ROSENTHAL GUSTAV**, liquors, wines &c. 107 North, house 15 Oregon.—*See page 562*
 Rosenthal Isidor, insurance agent, 26 Morris, house do.
 Rosenthal Joseph W. (*Rosenthal, Cauffman & Co.*), house 2 Rome
 Rosenthal Morris, tailor, house 52 Delevan
 Rosenthal Samuel, house 27 Clinton place
 Rosin Henrietta, widow, house 41 Joiner
 Rosner Charles, carpenter, bds. 77 Reynolds
 Rosner George, lockmaker, 188 State, house 77 Reynolds [170½ W. Main
 Ross Alexander, patternmaker, r. 136 Mill, b.
 Ross Andrew J. conductor, house 40 Cherry
 Ross Caroline E. widow, h. 120 Monroe av.
 Ross Catharine, boarding house, 170½ W. Main
 Ross Emily J. shoecutter, 124 Front, b. 170½ W. Main
 Ross Fanny, boards 126 Mt. Hope avenue
 Ross George, employé Osburn House
 Ross Jane, stitcher, boards 48 Jay [do.
 Ross Joseph A. porter, Whitcomb House, b.
ROSS LEWIS P. boots and shoes, wholesale, 147 State, house 118 West avenue.—*See page 592*
 Ross Mary M. house 9 Newton block [see
 Ross Oliver, laborer, h. Rapids road n. Gene-
 Ross Robert M. painter, house 139 Hunter
 Ross Sarah, widow, house 18 McDonald av.
 Ross Wm. E. laborer, b. 18 McDonald av.
 Rossiter George, laborer, house Mt. Hope av. near Mt. Hope
 Rossiter Sarah C. Mrs. house 21 S. Clinton
 Rossiter Susie, seamstress, house 110 State
 Rossiter Thomas L. ass't. pastor St. Mary's church, boards 7 South
 Ross Lewin George E. clerk, Bank of Monroe, 22 Exchange, b. 35 S. Clinton
 Ross Lewin George W. bookkeeper, 11 Mumford, house 27 State
 Ross Lewin Wm. H. (*Jarvis Lord & Co.*), 69 Mill, house 35 South Clinton

- Rossman Joseph, machinist, h. 4 Weeger
 Rossney Edward, foreman, Frost avenue c.
 Olean, house do. [road
 Rossney Patrick, teamster, h. rear Thurston
 Rossney William E. bookkeeper, 129 State,
 boards Frost av. c. Olean
 Roth Adam, gardener, boards 47 Sanford
 Roth Adolph, watchmaker, 30 W. Main, b.
 50 S. St. Paul
 Roth Anna, widow, boards 83 Champlain
 Roth Anthony, laborer, h. Clifford n. Hudson
 Roth Augustus, hairdresser, h. 30 Sibley's blk.
 Roth Caspar, carpenter, h. 84 Pinnacle av.
 Roth Charles, laborer, h. Thomas n. Clifford
 Roth Frederick, house 100 Mt. Hope avenue
 Roth George F. (*Roth & Co.*), 4 South av. b.
 100 Mt. Hope avenue
 Roth Heinrich, mason, house 47 Sanford
 Roth Henry, laborer, boards 89 Front
 Roth John, teamster, house Elm near Bay
 Roth John, laborer, boards 89 Front
 Roth John F. yardman, 21 Plymouth av. h.
 65 Scrantom
 Roth John G. baker, 307 State, bds. 23 Kent
 Roth Joseph, carpenter, house 7 Rhine
 Roth Joseph, carpenter, house 2 Henry
 Roth Joseph A. shoemaker, h. 266 St. Joseph
 Roth Lorenz, laborer, house rear N. Clinton
 near Norton
 Roth Matthias, mason, house 124 Hudson
 Roth Otto, baker, 154 W. Main, h. 1 Philander
 Roth Peter F. boards 84 Pinnacle avenue
 Roth Reinhart, mason, house 3 Almira
 Roth Rosalia, widow, h. North av. n. Stewart
 Roth Stephen, laborer, house 50 Litchfield
 Roth William, house 117 Mt. Hope avenue
 Roth William, blacksmith, 35 S. St. Paul,
 house 56 Sanford [grocers, 4 South av.
 Roth & Co. (*Geo. F. Roth and C. Eckhart*),
 Rathaug John, cabinetmaker, 7 N. Water,
 house 32 Hamilton place
 Rathaug William, market, 135½ Jay, h. do.
 Rothery Augustus, file cutter, house 21 Vin-
 cent place [9 Tonawanda
 Rothfritz Louisa, shoecutter, 87 N. Water, b.
 Rothfritz Sophia, shoecutter, 87 N. Water,
 house 9 Tonawanda
 Rothfritz Theresa, widow, b. 9 Tonawanda
 Rothgangel John F. (*Rothgangel & Co.*), house
 36 Fulton avenue
 Rothgangel & Co. (*John F. Rothgangel, J. W.
 Maser and C. F. Meyer*), glue manufs.
 Erie canal near Klinck
 Rothmond Martin, laborer, h. 41 Sanford
 Rothschild Bernard (*N. Levi & Co.*), 25 Mill,
 boards 71 N. Clinton
 Rothschild Fanny, widow, house 11 Atwater
 Rothschild Henry, boards 37 Atwater
 Rothschild Joseph, peddler, house 3 Helena
 Rothschild Meyer, salesman, h. 37 Atwater
 Rothschild Meyer J. cigarmaker, 52 North
 Clinton, boards 3 Helena [3 Helena
 Rothschild Samuel, tailor, 89 E. Main, bds.
 Rotman John, carpenter, house 29 Hoeltzer
 Rotmans Christopher, cabinetmaker, 2 Hill,
 boards 7 Thomas [7 Thomas
 Rotmans Henry, wagonmaker, 26 Vienna, b.
 Rotmans Henry J. house 7 Thomas
- Rouchel Frederick, baker, house 19 Cameron
 Rouchel John, house 35 Front
 Rouchel Mary, dry goods, 35 Front, h. do.
 Rouse Nellie, teacher, house Locust near
 Fulton avenue [Clinton n. Clifford
 Routhaug Frederick, wood moulder, bds. N.
 Row Augusta, dressmaker, b. 17 Broadway
 Row Charles E. medicine, house 12 Pearl
 Row Jacob, nurseryman, house Culver near
 Erie canal
 Row John I. dentist, house 17 Broadway
 Rowan James S. principal, St. Patrick's
 Academy, b. 143 Lyell [218 W. Main
 Rowbotham John, auctioneer, 102 Front, h.
 Rowe Frank E. clerk, 110 N. Clinton, boards
 33 Marietta
 Rowe Franklin, coachman, house 16 S. Ford
 Rowe George, hostler, 11 Andrews, boards
 N. St. Paul n. Marietta [15½ Spring
 Rowe George A. steward, 17 N. St. Paul, h.
 Rowe Hattie Miss, housekeeper, 151 South av.
 Rowe Robert, hostler, 11 Andrews, boards
 N. St. Paul n. Marietta [Allen
 Rowe Samuel B. jr. curtain fixtures, h. 62
 Rowe Thomas T. student, University of
 Rochester, boards 227 N. St. Paul
 Rowell Homer H. compositor, 3 West Main,
 house 87 South Union
 Rowlan Andrew, painter, boards 58 Chestnut
 Rowlan John, driver, house 58 Chestnut
 Rowlan Timothy D. painter, b. 58 Chestnut
 Rowland Mary, domestic, boards 26 Meigs
 Rowland Henry D. removed to Buffalo
 Rowland Merriman, fireman, h. 248 North
 Rowland Sarah J. domestic, b. 89 Alexander
 Rowland Thomas, foreman, 106 S. St. Paul,
 house 179 St. Joseph
 Rowland William, miller, house 9 North
 Rowley Anna B. dressmaker, b. 72 William
 Rowley David, jeweler, 11 Adams, h. do.
 Rowley Frank H. student, Rochester Theo-
 logical Seminary, b. 58 Monroe av.
 Rowley Jireh, deceased August 1875
 Rowley John, druggist, 51 Monroe av. house
 58 do. [house 44 Park avenue
 Rowley Manly D. (*Rowley & Hayes*), 8 State,
 Rowley Mary A. widow, house 24 Spencer
 Rowley Olive, widow, house 10 Lawrence
 Rowley Wm. C. (*Rowley & Johnston*), 41
 State, house 70 Plymouth avenue
 Rowley Wm. W. porter, Whitcomb House, h.
 5 George
- ROWLEY & HAYES** (*M. D. Rowley and M.
 D. L. Hayes*), insurance agents, 8 State,
 — See page 505
 Rowley & Johnston (*W. C. Rowley and D. L.
 Johnston*), lawyers, 41 State
 Roworth Joseph S. policeman, City Hall, h.
 82 Cypress
 Royal Wm. painter, house 135 Saxton
 Royce Benjamin Y. millwright, b. 19 Hill
 Royce Daniel D. painter, boards 101½ Allen
 Royce Edward M. carriage painter, 3 Canal,
 boards 101½ Allen
 Royce George F. clerk, 136 State, boards 27
 Emerson [27 Emerson
 Royce George M. steward, Congress Hall, h.
 Royce George S. agent, 3 Canal, b. 101½ Allen

HENRY C. WISNER,

COCKSON & CHETWYND'S WHITE GRANITE
 WARE, No. 33 STATE STREET.

Royce G. Henry, carriage maker, 3 Canal, b. 101½ Allen
 Royce James F. house 24 Park avenue
 Roycraft Cynthia, Miss, boards 85 Scio
 Royle Ralph, gardener, house 36 Meigs
 Rozisky John P. laborer, h. rear ft. of White
 Ruark Margaret, widow, boards 5 Davis
 Rubadeau George, cooper, house 24 Orchard
 Rubadeau Lydia Mrs. widow, b. 26 Orchard
 Rubadeau Mitchell L. switchman, house 26 Orchard
 Rubadou Francis, laborer, house 81 Lime
 Ruby Christ G. tailor, 1 Front, b. 149 Jay
 Ruby Frank A. machinist, boards rear 184 West avenue [rear do.
 Ruby George Mrs. grocer, 184 West av. h.
 Ruby Geo. jr. tucker, bds. rear 184 West av.
 Ruby John, teamster, house 25 North York
 Ruby John H. letter carrier, Post Office, bds. rear 184 West avenue
 Ruby John J. carpenter, North York near railroad, boards 25 do. [62 West av.
 Ruby Nicholas, coach trimmer, 3 Canal, bds.
 Ruch John, saloon, 94 Front, house do.
 Rucht Nicholas, carpenter, rear 59 Asylum, house 69 Hamilton place
 Ruckdeschel Frederick (*Michelsen & Ruckdeschel*), ft. Mill, house 41 Nassau
 Ruckdeschel Frederick jr. cabinetmaker, Hydraulic bldgs. bds. 41 Nassau
 Ruckdeschel John G. cabinetmaker, Hydraulic bldgs. bds. 41 Nassau
 Ruckel Caroline M. widow, b. 11 S. Union
 Ruckel Wm. B. clerk, bds. 11 South Union
 Rucker Jessie, waiter, 38 Fitzhugh, house 53 Spring
 Rudd Joseph, laborer, house 74 Frost av.
 Rudenauer Anthony, stone cutter, 8 West av. house 13½ Hawkins [b. 5 Zimmer
 Rudolph Christian, tobacconist, 55 S. St. Paul,
 Rudolph Frederick, tinsmith, house Caroline near Meigs
 Rudolph Gustavus, deceased, Aug. 19, 1875
 Rudolph John, tinsmith, house 51 Diem
 Rudolph Minnie Mrs. widow, b. 16 Walnut
 Rudolph Susan, widow, house 5 Zimmer
 Ruegg Anton, house 19 Herman
 Ruegg Michael, spinner, boards 19 Herman
 Ruf Conrad, packer, Ames near Jay
 Ruf Joseph, blacksmith, Brown c. Jones, h. Ames near Jay
 Ruf Thomas, hairdresser, Grand c. Whalin, house do. [cor. Caspar
 Ruff Anthony, carpenter, house North av.
 Ruff Balthaser, shoemaker, 14 State, house 82 Frances
 Ruff Conrad, medicine, 110 St. Joseph, h. do.
 Ruff George, cabinetmaker, 117 N. Water, b. 82 Frances
 Ruffee Caroline, widow, house 46 Kirk
 Rugamer John, flagman, State st. crossing, house 44 Hanover
 Ruge Henry, tailor, house 33 Weld
 Ruggles Josiah H. watchmaker, 3 State, h. Goodman near Monroe av. [do.
 Rugroff Joseph, cooper, rear 204 Jay, h. 202
 Rulifson Isaac H. bds. 47 Plymouth avenue
 Rulon Jacob, clerk, 7 S. St. Paul, bds. do.

Rumble George, carpenter, h. 34 S. Ford
 Rummel Balthaser, cabinetmaker, 2 Hill, h. 129 Hudson [ton
 Rummel Bernard, watchman, h. 136 N. Clin-
 Rummel Frank, cooper, house 47 Weld
 Rummel John, house 21 Goodman
 Rummel John B. moulder, bds. 47 Weld
 Rummel Levi F. clerk, Monroe av. c. Good-
 man, bds Park av. c. Goodman
 Rummel Margaret, widow, bds. 27 Bond
 Rummel Sarah C. tailoress, bds. 27 Bond
 Rumsey Byron, painter, house 28 Magne
 Rumsey Olive, widow, boards 28 Magne
 Rumsey Sarah F. Miss, boards 48 Pearl
 Runacre John, clerk, 48 Front, bds. 113½ S. St. Paul
 Runbacken Victor, pastor Congregation Aitz Raanon, house 6 Oregon
 Rund Frederick, tailor, house Hollenbeck
 Rundel Alice J. teacher, Concord School, No. 18, boards 44 North avenue
RUNDEL HENRY P. art gallery, 57 W. Main, house 55 Scio.—*See page 523*
 Rundel Morton W. real estate, 57 W. Main, boards 59 Fitzhugh
 Rung Frederick, shoemaker, house 25 Mark
 Runge Maria, tailoress, b. 69 Mt. Hope av.
 Running James H. h. 16 University avenue
 Rupp Bernard, butcher, house 8 Leopold
 Rupp George F. removed from city
 Rupp Louis, beer peddler, 106 Lake av. h. Leavenworth alley corner Champion
 Ruppanner James, books, 257 State, h. 35 Brown's alley
 Rupperecht Andrew, glass blower, 178 Plymouth av. bds. 146 Plymouth av.
 Ruppert Joseph, coachmaker, 3 Canal, house 141 Campbell [av. h. 130 Caledonia av.
 Ruppert Philip, blacksmith, 150 Plymouth
RURAL HOME PUBLISHING CO. 31 R Arcade.—*See under Blocks, Buildings, &c.*
 Ruscher J. Ernst, peddler, h. 116 Chatham
 Rush Charles, gasfitter, house 253 State
 Ruskell Priscilla Mrs. house 24 Griffith
 Ruskell Thomas, patternmaker, 130 Mill, h. 24 Griffith [Griffith
 Ruskell Thomas jr. clerk, 40 State, bds. 24
 Russ William, grinder, 8 Hill, h. Campbell near Ames [ory
 Russell Abigail A. widow, boards 13 Greg-
 Russell Adeline, widow, house 38 Lowell
 Russell Caroline, widow, house 11 Glasgow
 Russell Charles J. salesman, 14 Exchange, house Cazenovia [100 Mill
 Russell Duane, brakeman, N. Y. C. R. R. b.
 Russell Edward, shoemaker, b. 38 Lowell
 Russell George, hostler, Farmers' Hotel, h. 49 Lyell [South av.
 Russell George, plasterer, 16 Stone, h. 153
 Russell George jr. bds. 49 Lyell
 Russell George W. foreman, h. 192 E. Main
 Russell James, clerk, 14 Exchange, h. 35 Upton park
 Russell Jennie, widow, house 147 Exchange
 Russell John, conductor, N. Y. C. R. R. h. 12 Drayton [Thomas c. Bernard
 Russell John A. painter, 103 Thomas, bds.
 Russell John H. agent, bds. 49 Lyell

- Russell John L. shoemaker, 87 Pinnacle av. house do.
- Russell Joseph P. clerk, house 45 Tremont
- Russell Mary, widow, house 100 Exchange
- Russell Mary A. widow, h. Thomas c. Bernard
- Russell Mary A. dressmaker, boards 49 Lyell
- Russell Olive, widow, bds. 27 S. Washington
- Russell Osgood N. (*T. C. Russell & Co.*), 116 Plymouth av. house 140 Fitzhugh
- Russell Richard, fireman, h. 7 Railroad alley
- Russell Robert A. painter, 103 Thomas, h. Thomas corner Bernard [University av.
- Russell Robert, salesman, 53 E. Main, h. 4
- Russell R. P. millwright, bds. Ayers' Hotel
- Russell Sally widow, house 133 Monroe av.
- Russell Samuel, physician, house 125 Cady
- Russell T. Charles & Co. (*O. N. Russell and Mrs. E. C. Patterson*), dusters, 116 Plymouth avenue, house 22 East
- Rust Emma Mrs. millinery, 17 Hanover, h. do.
- Rust Frank A. sec. Rochester Brewing Co. ft. Cliff, house 17 Hanover
- Rutherford Arthur J. removed to Geneva
- Rutherford Robert, grain, bds. Whitcomb House [duct, h. 16½ Greenwood av.
- Ruthven Christian W. bookbinder, 1 Aqueduct Ann, bandbox maker, h. 17½ Montrose
- Rutz John, carpenter, house Langham n. St. Joseph
- Ryan Ann, widow, house 22 Frost avenue
- Ryan Annie, cook, Whitcomb House, b. do.
- Ryan Bridget, widow, house 14 Fulton av
- Ryan Celia, cutter, boards 40 Clinton place
- Ryan Edward, bartender, 157 N. Water, b. 40 Hand [5 do.
- Ryan Edward, carpenter, 3 Sycamore, house
- Ryan Eliza, widow, boards 14 Magne
- Ryan Ellen, boards 5 Lawrence
- Ryan Fannie, boards Upton pk. n. East av.
- Ryan George, laborer, house 8 Pine
- Ryan George R. pawnbroker, 16 W. Main, boards 57 William
- Ryan James, quarryman, house 12 Lowell
- Ryan James, varnisher, 184 State, b. Smith corner Bolivar
- Ryan James E. machinist, Brown's race near Furnace, h. 13 Hawkins [Washington
- Ryan James H. shoemaker, 4 Allen, b. 12 N.
- Ryan John, painter, boards 36 Smith
- Ryan John, laborer, 79 Front, house do.
- Ryan John, overseer, house Scio near railroad
- Ryan John, teamster, 17 Warehouse, house 36 Romeyn
- Ryan John, laborer, h. 40 Front [mouth av.
- Ryan John, coachman, 39 Spring, h. 34 Plymouth John C. assistant city surveyor, City Hall, house 45 Saratoga avenue
- Ryan Joseph, machinist, boards 95 Cady
- Ryan Joseph M. clerk, 29 East Main, boards 40 Hand
- Ryan Julia, widow, house 40 Clinton place
- Ryan Katie, cook, Whitcomb House, b. do.
- Ryan Margaret, stitcher, boards 36 Smith
- Ryan Margaret, widow, house 36 Smith
- Ryan Margaret, widow, h. 5 Stepheny's pk.
- Ryan Margaret J. tobacco packer, 182 State
- Ryan Martin, bricklayer, boards 5 Lawrence
- Ryan Mary, widow, bds. 5 Stepheny's park
- Ryan Mary, widow, house 40 Hand
- Ryan Mary, gilder, 38 Gorham, b. 12 Lowell
- Ryan Mary, stitcher, b. 36 Smith [Clinton pl.
- Ryan Mary T. forewoman, 15 Mill, b. 40
- Ryan Matthew, porter, 53 E. Main, house 3 Stepheny's park
- Ryan Michael, laborer, boards 95 Cady
- Ryan Michael, laborer, house 157 South av.
- Ryan Patrick, teamster, boards 14 Fulton av.
- Ryan Patrick, laborer, house 36 Romeyn
- Ryan Ribold, h. 57 William [Hamilton pl.
- Ryan Robert P. shoemaker, 111 State, h. 65
- Ryan Roger, porter, Congress Hall, h. 193 North St. Paul
- Ryan Sarah, widow, house 10 Sherman
- Ryan Sarah, stitcher, boards 10 Sherman
- Ryan Thomas, shoemaker, h. 139 S. St. Paul
- Ryan Thomas, removed to Chicago, Illinois
- Ryan Thomas, stonecutter, b. 157 South av.
- Ryan Thomas laborer, house 42 Romeyn
- Ryan Timothy, carpenter, h. 6 Fullam's pk.
- Ryan Timothy J. stonecutter, 54 Fitzhugh, house Peaeh alley [40 Hand
- Ryan William D. saloon, 157 N. Water, bds.
- Ryan William, packer, 5 Aqueduct, bds. 10 Sherman
- Ryan William, bill poster, bds. 12 N. Water
- Ryan William, tailor, house 82 Strong
- Ryan William, laborer, house 5 Lawrence
- Ryan William, laborer, house 95 Cady
- Ryckman James H. carpenter, Myrtle near Lyell, boards 13 Jones [place
- Ryder Thomas, tree agent, h. 10 Woodford
- Ryder Thomas B. bookkeeper, 73 E. Main, boards 10 Woodford place
- Ryder, see Rider
- Ryen John, brakeman, house 143 N. Union
- Rykenboer Frank, cartman, house 86 Kelly
- Rynd Richard, laborer, h. Champlain n. York
- SAAL JOHN E. mason, house 40 Gregory
- Saalwacher Jacob, blacksmith, 508 Brown, house 506 do.
- Sabey Edward P. carpenter, bds. 87 William
- Sabey Elizabeth L. dressmaker, b. 87 William
- Sabey Geo. A. (*Sabey & Son*), bds. 56 East av.
- Sabey James (*Sabey & Son*), h. 56 East avenue
- Sabey Mary A. widow, house 87 William
- Sabey Walter S. clerk, house 56 East avenue
- Sabey & Son (*J. & G. A. Sabey*), hats, caps, etc. 97 East Main
- Sabin Crittenden E. painter, h. 5 Edmonds
- Sabin Elroy F. clerk, County clerk's office, Court House, boards 4 Trowbridge
- Sabin E. Hoyt, foreman, Brown c. Erie canal, house 45 Oak
- Sabin Pamela A. widow, house 4 Marshall
- Sachs Frederick, house 50 Hudson
- Sachs Henry, stovemounter, 8 Hill, b. 9 Hill
- Sachs Louis, saloon, 160 North avenue, bds. 50 Hudson
- Sackett Chloe M. widow, bds. 98 South av.
- Sackett Daniel E. salesman, 36 State, house 71 Fitzhugh
- Sackett Richard B. (*Sackett & Popp*), house 57 Bartlett
- Sackett William, coachman, 73 Plymouth av. house 15 Hunter

Sackett & Popp (*R. B. Sackett and J. G. Popp*),
hairdressers, 29 Arcade
Sadden David J. collector, Democrat and
Chronicle, 3 W. Main, b. 32 N. Clinton
Sadden Henry, overseer, Rochester Cotton
Mill, h. 55 Magne [Mill, h. 23 Otsego
Sadden William, overseer, Rochester Cotton
Sadler Agnes, widow, house 96 Frances
Sadler John L. lithographer, 7 Market, bds.
96 Frances

SAFE DEPOSIT COMPANY, 31 State.—
See page 499

Saffran Conrad, cooper, 232 Jay, house do.
Saffran John, cooper, 232 Jay, boards do.
Safford Clara Mrs. boards 7 Trowbridge
Sage Edwin O. (*Pancost, Sage & Morse*), 92
State, house 72 Plymouth avenue
Sage John L. (*Pancost, Sage & Morse*), 92
State, house 46 East avenue
Sage Marilda, widow, house 1 Fitzhugh
Sage Nelson, 92 State, house 74 East avenue
Sage William, house 16 Arnold park
Sage William N. (*Pancost, Sage & Morse*), 92
State, house 81 Plymouth avenue
Sage W. Lincoln, salesman, 92 State, boards
81 Plymouth avenue [Weld, h. do.
Sagendorf Miranda Mrs. dressmaker, 80
Sagendorf Peter, laborer, house 80 Weld
Sager Nancy A. widow, house 67 Troup
Sahlberg Gustave, deceased July, 1875
Sahlberg Hannah, widow, boards 69 Troup
Sahler J. Hasbrouck, salesman, h. 5 James
Saile Joseph, market, 114 East Main, house
at Pittsford [near Goodman
Saile Martin, clerk, house Schanck avenue
Saile Peter, market, 149 E. Main, h. 60 Scio
Sailer Alberdina, widow, house Hague
Sailer Louis L. peddler, boards Hague
Saint Ange Cornelius, clerk, 119 East Main,
boards 67 Fulton avenue
Saint Ange Edward, clerk, b. 67 Fulton av.

SAINT ANGE JULIUS DE, French nur-
sery agent, 67 Fulton av. near Emerson,
house do.—See page 526

Salender Andrew, deceased 1875
Salender Catharine Mrs. house 106½ W. Main
Salender Laurence, cigarmaker, 178 W. Main,
boards 106½ do.
Sales Henry, laborer, house 98 North avenue
Salisbury Albert J. clerk, 70 Mill, boards 47
North Clinton [8 Chatham
Salisbury Alfred W. salesman, 64 Mill, house
Salisbury Anna, widow, h. 136 Plymouth av.
Salisbury Dora, widow, house 115 Brown
Salisbury George H. laborer, b. 136 Plymouth
avenue [near Troup
Salisbury Gilbert, hackman, house West alley
Salisbury Harvey, house 47 North Clinton
Salisbury H. Franklin, foreman, 122 Mill, b.
47 North Clinton
Saller William (*Saller & Schlitzer*), boards 135
St. Joseph
Saller & Schlitzer (*Wm. Saller and J. Schlitzer*),
hairdressers, Brackett House
Salley James J. fireman, Erie railway, house
8 Greig
Salmon Andrew J. machinist, bds. 73 Joiner
Salmon Catharine, widow, boards 36 Pearl

Salmon Charles, grocer, 45 Andrews, house
44 North Clinton [44 N. Clinton
Salmon Frank, clerk, 45 Andrews, boards
Salmon Peter, machinist, 123 Mill, b. 73 Joiner
Salmon Sarah A. widow, house 73 Joiner
Salter Grace, widow, house 15 Penn
Salter John W. clerk, N. Y. C. freight office,
Platt c. Kent, b. av. A cor. Conkey av.
Salter Josiah, nursery, 319 University avenue,
house do. [avenue A
Salter Lizzie, milliner, bds. Conkey av. cor.
Salter Mary Miss, house 27 Atkinson
Salter Richard, gardener, house av. A cor.
Conkey av. [Conkey av.
Salter Richard jr. clerk, boards av. A cor.
Salter Robert, dentist, 78 State, bds. 13 Penn
Salter Sarah G. dressmaker, bds. Conkey av.
corner avenue A

SALTER THOMAS, carpenter and con-
tractor, 148 Plymouth av. house Frost av.
near Olean.—See page 635

Salyerds Henry W. tinsmith, 48 North av. h.
16 Hollister
Salyerds Isaac W. removed to Scottsville
Salzer Anna M. widow, house 249 St. Joseph
Salzer Jacob, carpenter, house North avenue
near Clifford
Salzer Jacob, shoemaker, h. 249 St. Joseph
Salzer Michael, tailor, 14 Mumford, house
Drayton near North

Samain Charity, widow, boards 8 Oak
Same Charles, laborer, h. Union n. Jennings
Same Frank, nurseryman, house Goodman
near Bay [Henry
Same John, house tucker, house Weegee n.
Same Laurie, tucker, boards 108 Tappan
Same Michael, laborer, house Fifth avenue
near Bay [h. 27 Broadway
Samenfink Jacob, driver, 207 South St. Paul,
Samenfink Vincent, foreman, 207 South St.
Paul, house 47 Broadway

Sames Dorothea C. E. widow, h. 87 Kelly
Samlinger Sarah Mrs. house 247 State
Sammons Mary P. widow, h. 32 S. Clinton
Sample Esther, deceased May, 1875
Sampson George, boatman, house 18 Griffith
Sampson Henry J. saloon, 182 West av. h. do.
Sampson James, removed from city
Sampson N. A. widow, house 82 Clifton
Sampson Theron A. photographer, 108 State,
boards 14 Swan [201 do.
Sampson Thomas, handlemaker, 153 State, h.
Sampson Thomas, mason, h. 92 Exchange
Samson Amos S. farmer, h. Rapids road n.
city line [25½ Scio
Samuel Elizabeth, clothing, 18 Front, house
Samuel Henry S. clothing, 145 E. Main, b.
25½ Scio
Samuel Isaac S. 18 Front, h. 25½ Scio
Samuel Marcus, clothing, 62 Front, boards
12 Scio
Samuel Nathan, clerk, 18 Front, b. 25½ Scio
Samuel Samuel, clerk, 18 Front, b. 25½ Scio
Samuel Sophia, teacher, Oakman School,
No. 20, boards 25½ Scio
Sanborn Caroline M. fancy drygoods, 66
South avenue, house do.
Sanborn Rodman W. house 68 Mt. Hope av.

A. R. PRITCHARD & LIKLY,

**SHAWL STRAPS,
No. 78 STATE STREET.**

- Sanborn William B. clerk, 111 Mill, boards
66 South avenue [n. Rapids road
Sanborn William H. ice dealer, h. Genesee
Sander Joseph, upholsterer, house 38 Joiner
Sander Louis, lockmaker, Court cor. Stone,
boards 63 St. Joseph
Sander Roman, machinist, Court cor. Stone,
house 13 Catharine [Joseph
Sander Valentine, iron finisher, house 63 St.
Sander Valentine jr. lockmaker, Court cor.
Stone, boards 63 St. Joseph
Sander William, tailor, 228 West Main
Sander, see Zander [N. Clinton
Sanderl Alphonsus, marble cutter, boards 105
Sanderl John B. shoemaker, 105 N. Clinton,
boards 100 do.
Sanderl Vitus, shoemaker, house 105 North
Clinton [Reynolds
Sanders John S. machinist, 3 Canal, house 35
Sanders Leo, machinist, house 250 N. Clinton
Sanders Mark, butcher, 92 Plymouth av. h.
2 Summer alley
Sanders Thomas J. canvasser, 43 State, h.
29 Adams [boards do.
Sanderson Geo. T. waiter, Brackett House,
SANDERSON ISAAC H. pictures, frames,
&c. 24 Exchange, house 7 Madison pk.
—See page 523
Sands George M. removed to Boston, Mass.
Sands, see Sans
Sanduskey Joseph, peddler, h. 7 Herman
Sandway William F. student, 54 Powers'
buildings, boards 5 South Clinton
Sanford Charles L. shoemaker, River near
North Water, house 25 Nassau
Sanford Harriet, widow, house 43 State
Sanford Harriet, widow, b. 88 West avenue
Sanford John T. laborer, paper mill, boards
2 McCracken [Lake av.
Sanford Joseph, turner, bds. McCracken n.
Sanford J. Edward, dentist, 10 Elwood bl.
house 33 South Washington
Sanford Lamont H. engine despatcher, N. Y.
C. R. R., Brown, house 35 Madison
Sanford Marcus B. housekeeping goods, 121
East Main, house 64 South Union
Sanford Michael, papermaker, h. McCracken
near Lake av. [S. Washington
Sanford Truman B. dentist, 43 State, boards
Sanford William, sawyer, lower falls, boards
McCracken near Lake avenue
Sanford William L. clerk, freight house,
Platt cor. Kent, boards 35 Madison
Sanger Jacob, nurseryman, h. 38 Scramton
Sankey James P. pastor United Presbyterian
church, 181 Powers' buildings, house 18
South Washington
Sans George, clerk, 90 W. Main, h. 27 Martin
Santrock Christopher, butcher, h. Bay near
Goodman
Santry Mary, widow, h. Gates av. near Otis
Sarbrook William, laborer, h. 116 Alexander
Sargent Albert H. bookkeeper, 62 State, bds.
29 Vick park [h. 111 Alexander
Sargent Daniel W. fruit plates, 22 Exchange,
Sargent Deborah, b. East av. cor. Alexander
Sargent Edwin R. shoemaker, Andrews cor.
North Water, house 243 State
Sargent Esther Miss, h. Pinnacle av. n. Field
Sargent Henry, lawyer, 46 Arcade, house 40
Chestnut
SARGENT HENRY D. & CO. (*J. Rapalje*),
dress and upholstery trimmings, 98 East
Main, boards 44 North av.—See page 645
Sargent James (*Sargent & Greenleaf*), Court
cor. Stone, house 60 East avenue
Sargent John, builder, house 29 Vick park
Sargent L. Amelia, widow, b. Hudson near
Norton
Sargent Mary W. deceased Sept. 1875
SARGENT & GREENLEAF (*J. Sargent*
and H. S. Greenleaf), bank, safe and key
lock manufs., Court corner Stone.—See
front colored page
Sargisson John N. carpet weaver, 42 Frost
avenue, house do.
Sarony Clark L. artist, boards 146½ W. Main
Sartchfield James, teamster, h. Henrietta av.
near Pinnacle avenue
Sass Charles T. laborer, house 48 Hoeltzer
Sattel Peter, laborer, Court st. bridge, house
Alphonse near Thomas
Satter Francis, farmer, h. Hudson opp. Ber-
lin [Berlin
Satter Mary A. widow, house Hudson opp.
Satter Mary, widow, house 144 Hudson
Satterbee Joseph, shoemaker, 15 Mill, house
4 Rauber
Satterlee Emma R. teacher, Riley School No.
14, boards Atwater cor. Oregon
Satterlee Eugene H. (*Satterlee & Yeoman*), 53
Powers' bldgs. b. Atwater cor. Oregon
Satterlee LeRoy, ventilating, 45 Powers'
buildings, house Atwater c. Oregon
Satterlee & Yeoman (*E. H. Satterlee and Geo.*
F. Yeoman), lawyers, 53 Powers' bldgs.
Sauer Abbalonie, widow, house 15 German
Sauer Adam, rubbermaker, 141 N. Water,
boards 15 German
Sauer Anthony F. augermaker, foot North
Water, n. R. R. h. 99 North Clinton
Sauer Anthony, cabinetmaker, 133 N. Water,
house 91 North Clinton
Sauer Frank, carpenter, boards 18 William
Sauer Henry G. carpenter, house 7½ Gregory
SAUER JACOB, cigar boxes and moulds,
ft. Aqueduct, h. 58 Hickory.—See p. 564
Sauer Jacob C. shoe fitter, house 18 Andrews
Sauer John, carpenter, house 2 Sauer's park
Sauer John C. carpenter, house 18 William
Sauer Maria, widow, boards 2 Sauer's park
Sauer Mary J. organist, boards 58 Hickory
Sauerbier Frederick, removed to Elmira
Sauerbier John C. laborer, house Jennings
near North avenue
Sauerteig Joseph, clerk, 27 Front, boards do.
Sauerteig Robert, saloon, 27 Front, house do.
Saunders Albert A. lather, b. 4 Plymouth av.
Saunders Charles, carpenter, Scott alley, bds.
9 Martin [9 Martin
Saunders Herbert, carpenter, Scott alley, bds.
Saunders Jane, widow, house 5 Prospect
Saunders John, peddler, house 67 Charlotte
Saunders Joseph, gatetender, N. Y. C. R. R.
depot, house 24 South Union [Martin
Saunders Oliver W. carpenter, Scott al. b. 9

Saunders Philip R. removed to Parma
 Saunders Richard, butcher, 64 West avenue,
 boards 5 Prospect
 Saunders Sarah A. widow, h. 4 Plymouth av.
SAUNDERS WILLIAM, carpenter and
 builder, Scott alley near Allen, house 9
 Martin.—See page 634
 Saunders William L. agent, house 8 Summer
 Sauter Frank, currier, 87 North Water, h.
 West Maple near Ames
 Sauter Michael, laborer, house 35 Herman
 Sautler Fred. hairdresser, 59 Jay, bds. 77 do.
 Sautorius Jacob, laborer, house 126 South av.
 Savage Ann, trunks &c. 72 State, house 39
 Franklin [boards at Gates
 Savage Arthur, painter, 49 Walbridge's block,
 Savage Edgar, removed to England
 Savage Eleazer Rev. house Scottsville road
 at Rapids [avenue
 Savage Elizabeth, muff liner, b. 71 University
 Savage Fred. J. shoemaker, 87 N. Water, b.
 25 Reynolds
 Savage George, stonecutter, h. 29 Reynolds
 Savage Henry, painter, house 113 Orange
 -Savage Henry, painter, deceased 1876
 Savage James, laborer, house 3 Cliff
 Savage Jeremiah, machinist, 124 Mill, bds.
 71 Orange
 Savage John, clerk, Park House, Rochester
 Driving Park, house 126 Lake avenue
 Savage Mary, widow, house 25 Reynolds
 Savage Maurice, cartman, house 71 Orange
 Savage Morris A. trunks, 72 State, house 39
 Franklin [39 Franklin
 Savage Saul H. bookkeeper, 72 State, boards
 Savard Joseph, tanner, 321 N. St. Paul,
 house 6 Harrison
 Savard Joseph H. clerk, 28 Arcade, boards
 21 Harrison [Harrison
 Savard Peter, tanner, 37 N. Water, house 21
 Savary George, ins. adjuster, 132 Powers'
 bldgs. boards 14 Chatham [bds. do.
 Savigny Minnie, waiter, Whitcomb House,
 Sawtelle Edwin H. foreman, 7 W. Main, h.
 30 University avenue [Plymouth av.
 Sawtelle Elizabeth P. widow, boards 122
 Sawtelle Frank A. boards 48 Delevan
 Sawtelle John, doormaker, 7 West Main, h.
 48 Delevan
 Sawyer Alvah L. engineer, Allen n. North
 Washington, house 15 Champlain
 Sawyer Herman, stonecutter, bds. 4 N. Ford
 Sawyer James W. house 29 Allen
 Sawyer William E. engineer, 92 Allen, house
 55 Litchfield
 Sax John, currier, 43 Front, h. 163 Wilder
SAX SIGMUND, book binder and picture
 mounter, 51 Front, boards 49 do.—See
 page 519 [7 Arnold park
 Saxe Asa, pastor Universalist Church, house
 Saxelby John, removed to Canada
 Saxton Cornelia K. Miss, house 61 Atkinson
 Saxton James M. clerk, 85 E. Main, boards
 Whitcomb House
SAYER JOSEPH, liquors, wines, &c. 132
 West Main, house do.—See page 561
 Sayers James, hostler, Lake avenue near
 Ridgewood, boards 35 Hand

Sayles Mary A. Mrs. house 230 N. Clinton
 Sayles Philip, shoemaker, house 160 E. Main
 Sayre Geo. M. salesman, 91 North Water, b.
 36 Fitzhugh
 Sayward Albert A. agent, house 2 Joslyn pk.
 Scanlan Bridget, widow, house 117 Fitzhugh
 Scanlan Michael, hostler, State cor. Centre,
 house 81 Meigs
 Scanlan Thomas F. machinist, b. 83 Meigs
 Scanlan William, house 83 Meigs
SCANLIN DANIEL, crockery, china &c.
 68 West Main, and proprietor Spencer
 House at Charlotte, bds. do.—See p. 628
 Scanlin Jeremiah, salesman, 41 E. Main, h.
 17 Marietta
 Scanlin John, boards 62 Exchange
 Scanlin John, laborer, house 25 S. St. Paul
 Scanlin John H. whipmaker, Allen near N.
 Washington, boards 83 Meigs
 Scanlin Richard, clerk, 68 West Main,
 house 3 Ward [h. 176 St. Joseph
 Scanlin Timothy, switchman, N. Y. C. R. R.
 Scanlin William, melter, 187 W. Main, house
 25 Hudson [25 Hudson
 Scanlin William jr. moulder, 187 W. Main, b.
 Schaab Joseph M. clerk, boards 8 Stone
 Schaab Mary C. widow, house 8 Stone
 Schaad Philip, grocer, 116 South av. h. do.
 Schaaef John, clergyman, house 23 Wilson
 Schaaef Dirk, finisher, 74 State, h. Huron n.
 St. Joseph
 Schad Conrad, cabinetmaker, 133 N. Water,
 h. 106 Pinnacle av.
 Schad Henry, butcher, 36 Front, boards do.
 Schad Joseph, cabinetmaker, 133 N. Water,
 boards 106 Pinnacle avenue
 Schad Philip, tailor, 185 N. Clinton, h. do.
 Schad Philip, tailor, boards 106 Pinnacle av.
 Schadley Emma, widow, boards 36 Gibbs
 Schaedeli Emile, removed from city
 Schaefer Adam, teamster, house 16 Bond
 Schaefer Barbara, fancy goods, 111 North
 Clinton, boards 69 Joiner
 Schaefer Charles, carpenter, boards 16 Bond
 Schaefer Edward, clerk, 24 Joiner, bds. do.
 Schaefer Edward P. hairdresser, 87 St. Jo-
 seph, boards 89 do.
 Schaefer Elizabeth, grocer, 24 Joiner, h. do.
 Schaefer Ferdinand, clerk, 24 Joiner, b. do.
 Schaefer Frank J. saloon, 89 St. Joseph, h. do.
 Schaefer Frank J. jr. (*Schaefer & Bro.*), h.
 Reynolds cor. Adams
 Schaefer Gebard, boilermaker, Platt corner
 Kent, house 11 Wilder
 Schaefer Gebhardt, mason, house 84 Weld
 Schaefer Godfried (*Schaefer & Bro.*), boards
 Reynolds cor. Adams [69 Joiner
 Schaefer Joseph, clothing, 50 N. Clinton, h.
 Schaefer Joseph, carpenter, bds. 18 William
 Schaefer Joseph F. boards 37 Baden
 Schaefer Peter, laborer, house 11 Catharine
 Schaefer Philip, clerk, 83 E. Main, bds. do.
 Schaefer Wm. market, 128 Sciö, house do.
 Schaefer & Brother (*F. A. Schaefer jr. and
 G. Schaefer*), grocers, Reynolds c. Adams
 Schaeffer Chas. F. clerk, 105 Lyell, bds. do.
 Schaeffer Christian J. grocer, 105 Lyell, h. do.
 Schaeffer John F. boards 103 North Clinton

- Schaeffer John J. grocer, 103 N. Clinton, house do. [do.]
- Schaeffer Louis P. clerk, 103 N. Clinton, b. Schaenthaler Frederica, tailoress, b. 40 Kirk
- Schaenthaler Jacob, painter, house 52 Kirk
- Schaenthaler Louis, tailor, boards 52 Kirk
- Schafer Charles J. tinsmith, 90 East Main, h. 40 Andrews [3 North Ford]
- Schafer Frederick, brewer, 106 Lake av. h.
- Schafer George, laborer, 27 N. Water, house 14 Kondolf [boards 28 Atwater]
- Schafer George, photographer, 83 E. Main,
- Schafer George, blacksmith, house Thomas near Clifford [h. av. A. n. Conkey av.]
- Schafer Gerhard, shoemaker, 79 N. Water,
- Schafer Henry, carver, River n. N. St. Paul, boards 14 Atwater
- Schafer John, stove mounter, h. 99 Champlain
- Schafer John A. carriagemaker, 31 Mumford, h. Jennings c. North av. [Clifford]
- Schafer John A. carpenter, b. Thomas near
- Schafer John M. grocer, 20 West av. h. do.
- Schafer John N. laborer, h. avenue A near Conkey avenue
- Schafer Joseph, boatbuilder, house 28 Grand
- Schafer J. Nicholas, mason, h. 1 N. Ford
- Schafer Margaret, widow, house 73 Scratom
- Schafer Margaret, widow, house 28 Atwater
- Schafer Mary Miss, boards 73 Scratom
- Schafer Matthew, farmer, bds. Thomas near Clifford
- Schafer Philip, boards Alphonse n. Hudson
- Schafer Susan Miss, tailoress, 48 Martin, b. avenue A [Sprague's Hotel]
- Schafer William, butcher, 158 State, boards
- Schafer Wm. W. carpenter, bds. 1 N. Ford
- Schaff Sylvester, blacksmith, house 4 Whitmore park
- Schaffer Geo. V. forwarder, house 28 Comfort
- Schaffer Geo. V. jr. boatman, b. 28 Comfort
- Schaffer Herman M. prof. Roch. Theological Seminary, house 23 Edmonds [h. do.]
- Schaffer Jacob, grocer, 168 Plymouth av.
- SCHAFFER JACOB C.** glass mould manufacturer, 6 Hill, boards 168 Plymouth av. —See page 684
- Schaffer John, mouldmaker, 6 Hill, b. 168 Plymouth avenue
- Schaffer John N. stone mason, h. 90 Hunter
- Schaffer Joseph, laborer, boards 52 Childs
- Schaffer Lawrence, engineer, h. 52 Hudson
- Schaffer William, teamster, boards 88 Pearl
- Schaffert William, turner, 71 N. St. Paul, h. 30 Sanford
- Schaffner Frederick, carman, h. 88 North av.
- Schaffner Frederick jr. salesman, 73 State, b. 22 Jones [house 23 Lewis]
- Schaffner Rudolph, machinist, Brown c. Jones,
- Schaich C. Lawrence (*L. Schaich & Son*), b. 181 North Clinton
- Schaich Lawrence & Son (*C. L. Schaich*), music publishers, 181 N. Clinton, h. do.
- Schain Wm. cabinetmaker, house 65 Smith
- Schairer Anton, shoemaker, 133 Lake av. h. do.
- Schake Adam, painter, house 56 Weld
- Schake Adam (*J. & A. Schake*), 94 East av. house 2 Park avenue
- Schake John A. painter, boards 74 William
- Schake John & A. market, 94 East av. house 74 William
- Schakow Carl, carpenter, house 31 Oakman
- Schakow Otto, carpenter, house 31 Oakman
- Schalber Charlotte, tailoress, boards Strong corner Seward
- Schalber Jacob G. machinist, Exchange opp. Glasgow, house Strong c. Seward
- Schaler Christina, widow, h. 102 North av.
- Schallmeyer Adam, stone cutter, house 70 Gregory [avenue, house do.]
- Schamine Peter, boots and shoes, 97 South
- Schanck Henry D. farmer, h. Culver near Schanck av.
- Schanck Hendrick V. B. farmer, h. Culver cor. Schanck av.
- Schanck Peter V. mason, b. 37 University av.
- Schanck William W. mason, 163 East Main, house 40 University avenue
- Schang John, showcases, 53 Front, house do.
- Schankel Andrew, electrotyper, 93 State, h. 7 Grand [Flower]
- Schante Ann C. widow, h. N. Clinton near
- Schante George, engineer. 15 Mill, b. North Clinton near Flower
- Schante Nicholas, deceased, Aug. 1875
- Schantz Gilbert, foreman, house 38 Meigs
- Schantz Gustave, clerk, 77 Mill, boards do.
- Schantz Henry (*Schantz, Minges, Shale & Co.*), house 46 Charlotte
- Schantz John, house 46 Charlotte
- Schantz Joseph (*Schantz, Minges, Shale & Co.*), house 7 Pleasant
- Schantz Joseph A. student, bds. 38 Meigs
- SCHANTZ, MINGES, SHALE & CO. (J. Schantz, F. S. Minges, F. A. Shale and H. Schante)**, furniture, 15 North Water. —See page 622
- Schanz Otto, laborer, house 19 Hope
- Scharp Louis, painter, house 127 Scio
- Scharpf Frederick, optician, 179 N. St. Paul, boards 23 Lowell [18 Clifford]
- Schaub Ernst J. F. tinsmith, 208 W. Main, h.
- Schauber Jerome, shoemaker, 7 Andrews, h. 62 Hanover
- Schaubert Chas. cabinetmaker, h. 11 Bond
- Schaubert Conrad, shoemaker, h. 56 Hamilton place [N. Water, h. 41 S. Ford]
- Schaubert George, shoemaker, Andrews cor.
- Schaubert John, wagonmaker, 115 South St. Paul, house rear 17 Sanford
- Schaum Geo. C. carpenter, house 6 Summer
- Schaum Marietta, widow, boards 6 Summer
- Schauman Christian, cabinetmaker, house 4 Buchan park
- Schauman-Frederick, h. 3 Elizabeth place
- Schauman Fred'k jr. mason, h. 14 Buchan pk.
- Schauman Herman, cabinetmaker, 38 Gorham, boards 3 Elizabeth
- Schauman Louis, cabinetmaker, 102 East Main, house 17 Buchan park
- Schantz Chas. potter, 4 Mt. Hope av. h. 25 do.
- Schauz Frederick, peddler, h. 153 Champlain
- Schauz George, porter, house 7 Thompson
- Scheck August H. optician, 179 N. St. Paul, house 22 Martin
- Scheck John, boards 76 Martin
- Scheck Magnus, cutter, 64 Mill, h. 76 Martin

HENRY C. WISNER,

WHITE CHINA DINING and TEA SETS,
No. 33 STATE STREET.

Scheely Charles L. clerk, 92 East av. b. 122 North avenue [house 112 Hudson
 Scheely John M. switchman, N. Y. C. R. R. boards 112 Hudson [Jones, h. 226 Jay
 Scheely Leonard, turner, 135 North Water, Scheettinger George, blacksmith, Brown cor.
 Scheffel John, sausagemaker, 164 S. St. Paul, house do. [164 S. St. Paul
 Scheffel Wm. upholsterer, 7 N. Water, bds. Scheib Albert C. brakeman, N. Y. C. R. R. boards Hudson cor. Berlin [Berlin
 Scheib Elizabeth, widow, house Hudson cor. Scheib Elizabeth F. widow, b. 27 Scramont
 Scheib John, barber, Elm c. E. Main, bds. 30 Rhine [Ackerman n. Bay
 Scheib Joseph, dry goods, 233 North, house Scheib Mary, widow, house 168 Scio
 Scheib Peter H. shade painter, h. 147 Jay Scheib Wilhelmina Mrs. midwife, 147 Jay, house do. [h. 61 St. Joseph
 Scheib William J. conductor, N. Y. C. R. R. Scheibe August, pattern maker, 129 Mill, boards 77 Magne
 Scheibe C. August, moulder, Brown's race n. Furnace, house 32 Sherman
 Scheick John, laborer, boards 6 Baden Scheid Ferdinand, tailor, 100 State, house 5 Railroad alley
 Scheid Peter, tailor, house 26 Grape Scheidnagel Anthony, cabinet maker, 123 Mill, house 11 McDonald avenue
 Scheidnagel Augustin, grocer, Hudson cor. Bernard, house do.
 Scheidnagel Frances, widow, 39 Gorham Scheidnagel George, deceased, 1875
 Scheidnagel John, shoemaker, h. Hoelfer n. North Clinton
 Scheidnagel Joseph, deceased June, 1875 Scheidnagel Josephine, widow, h. 20 Brown's alley [house 7 Morris
 Scheiderich Theodore, shoemaker, 50 Front, Schelida Emil, machinist, house 22 Pryor
 Schell Joseph, house 239 Plymouth avenue Schell Joseph, boards North av. n. Jennings
 Schell Mary A. widow, house 23 Thomas Schellbert Charlotte Mrs. h. Cottage n. Plymouth avenue [n. St. Joseph
 Schelleman Abram, upholsterer, b. Clifford Schelleman Adriann, painter, house Clifford near St. Joseph [Joseph
 Schelleman Jacob, carver, b. Clifford n. St. Schelleman Jacob, laborer, h. 35 Concord av.
 Scheller Henry, laborer, house 189 Scio Schellhorn Lewis, tailor, house 160 Jay
 Schelter Geo. cigarmaker, 104 St. Joseph, house do. [bldgs. b. 109 Chatham
 Schelter George 2d, cabinetmaker, Hydraulic Schench Albert H. removed to N. Y. city
 Schenck Emil (H. Schenck & Son), boards 63 Hickory
 Schenck Henry & Sons (E. & L. Schenck), music teachers, 191 Powers' bldgs. house 63 Hickory [63 Hickory
 Schenck Ludwig (H. Schenck & Sons), bds. Schenguliet August, tailor, 10 West Main, house 54 Cady
 Schenk Florian, tailor, house 54 Joiner Schenk Stephen, carpenter, h. 57 Herman

Schenkel Catharine F. stitcher, bds. 130 Jay Schenkel Frank, house 130 Jay
 Schenkel Helena, seamstress, bds. 130 Jay Scheon Mary, widow, h. Genesee c. Clifton
 Scherer Charles, tailor, house 10 Munger Scherer Frank, grocer, Childs c. Jay, h. do.
 Scherer Frank, laborer, 122 S. St. Paul, h. 7 Weeger [Edward
 Scherer John H. mason, h. Alphonse corner Scherer Joseph S. blacksmith, bds. 137 Lake avenue [house r. 28 Stone
 Scherer Martin, cigarmaker, 218 West Main, Scherer Max, varnisher, 4 Hill, h. 155 Hudson
 Scherer Stephen (Scherer & Benner), house 137 Lake avenue
 Scherer Wm. cutter, 74 Mill, h. 64 Nassau Scherer & Benner (S. Scherer and C. Benner), blacksmiths, r. 137 Lake avenue
 Scherff Joseph, carpenter, 14 St. Joseph, h. 25 German [N. Clinton n. Clifford
 Schermer Jacob, bootmaker, 92 State, house Schermerhorn Emmett, clerk, 64 North av. house 66 Tappan
SCHERMERHORN JOHN V. N. grocer, 64 North av. house 13 Rome.—See p. 561
 Schermerhorn R. Emma, surrogate's office, Court House, boards 26 Elizabeth
 Scherwin Julius, watchmaker, b. 6 Chestnut Scheuch Charles, laborer, h. Pinnacle av. n. Henrietta av. [h. 223 St. Joseph
 Scheuch John, shoemaker, 10 S. St. Paul, Scheuch John, carpenter, h. Caroline n. Diem
 Scheuch Lena, widow, bds. Caroline n. Diem Scheuer Adam J. jr. (G. P. Meyer & Co.), River n. N. St. Paul, b. 67 Hamilton pl.
 Scheuer Adam J. boat builder, house 67 Hamilton place
 Scheuer Valentine, cartman, house 3 Dover Scheuerman Andrew, shoemaker, house 40 Campbell [ine, house 15 Rauber
 Scheuerman Charles, shoemaker, 20 Cathar-Scheurman Charles, cigarmaker, bds. 40 Campbell
 Schible H. removed to Brighton Schick Conrad, laborer, 66 E. Main, house 339 N. Clinton [2 Martin
 Schick Jacob P. printer, 23 West Main, h. Schick Joseph, shoemaker, 124 W. Main, h. 135 Campbell [131 Hudson
 Schicker Bros. (M. & G. Schicker), bakers, Schicker Geo. (Schicker Bros.), h. 131 Hudson
 Schicker Martin (Schicker Bros.), boards 131 Hudson [railroad
 Schied Ferdinand, tailor, h. Railroad al. n. Schied Michael, laborer, house 73 Campbell
 Schied see Shied Schiefbenger Matthew, laborer, h. 29 Rauber
 Schieman August, tailor, house 18 Pryor Schiff Leopold, peddler, house 6 Foelner
 Schiff William, peddler, boards Pinnacle av. cor. Munger
SCHIFFNER ALBERT, upholstery goods, 50 E. Main, h. 233 Exchange.—See page 629
 Schiffner Albert M. upholsterer, 50 E. Main, boards 233 Exchange
 Schiffner George W. upholsterer, 50 E. Main, boards 233 Exchange

- Schild Edward E. file cutter, River n. North Water, h. North avenue near Bay
- Schild Jacob, shoemaker, 51 Front, house 65 North avenue
- Schild Joachim, laborer, house 39 Hoeltzer
- Schild John, carpenter, bds. 65 North av.
- Schill Gustav, music teacher, b. 116 North Water [76 Chatham
- Schiller Alois, moulder, 150 N. Water, h.
- Schiller Benedict, moulder, h. 117 Chatham
- Schiller Charles, upholsterer, 53 State, b. 117 Chatham [bds. 117 Chatham
- Schiller William, axlemaker, 154 N. Water,
- Schilling Anthony, shoemaker, 27 Walbridge's block, boards 113 Scio
- Schilling Conrad, mason, house 113 Scio
- Schilling Gustave, cigarmaker, 48 Exchange, house 23 Ontario [Maple
- Schillo John, moulder, 8 Hill, bds. 108 West
- Schils John, laborer, b. Henrietta av. near Pinnacle av. [nacle avenue
- Schils Kate, widow, h. Henrietta av. n. Pin-
- Schimmel Dora, widow, h. 111 Mt. Hope av.
- Schimmel John B. butcher, boards 111 Mt. Hope avenue
- Schimmel Joseph A. removed from city
- Schinck Julius A. engraver, 23 West Main; boards 171½ East Main
- Schipper Charles, laborer, house 23 Henry
- Schirck Albert, machinist, 15 Warehouse, b. 24 East Maple
- SCHIRCK ALEXANDER & CO. (G. Schirck and J. Smith),** axle makers, 15 Warehouse, h. 16 Erie.—See page 682
- Schirck Andrew, machinist, boards 23 East Maple [b. 24 E. Maple
- Schirck Edward, machinist, 15 Warehouse,
- Schirck George (A. Schirck & Co.), bds. 24 East Maple [24 East Maple
- Schirck Louis, machinist, 15 Warehouse, b.
- Schirck Margaret, widow, h. 24 East Maple
- Schirck Mary A. widow, h. 221 Plymouth av.
- Schlaefer William, mason, house 4 Wilder
- Schlaffer Valentine, saloon, 18 Exchange pl. house do. [ander
- Schlagel Caroline, housekeeper, h. 121 Alex-
- Schlagel John, laborer, h. r. 305 N. St. Paul
- Schlagel Michael, mason, h. 121 Alexander
- Schlagel see Schloegel and Schlegel
- Schlager Frederick, laborer, Model Mills, S. Water, h. Railroad al. n. North York
- Schlager Michael, laborer, boards Railroad al. near North York [alley
- Schlagter Lena, widow, h. Perkins c. White
- Schleber Doratha Mrs. boarding house, 91 Front, house do. [b. 91 Front
- Schleber Henry H. jeweler, 88 Powers bldgs.
- Schleber John G. saloon, 24 N. Water, h. do.
- Schlechter Christian, mason, h. Allmeroth n. Henrietta avenue
- SCHLEGEL CHARLES F.** stoves, tinware and roofing, 92 St. Joseph, house do.—See page 627
- Schlegel Conrad, laborer, house 58 Lewis
- Schlegel Fred'k, nurseryman, h. 119 South av.
- Schlegel John, butcher, 119 N. Clinton, b. do.
- Schlegel John G. cabinetmaker, Jay c. Erie canal, house 11 Concord avenue
- Schleifer John, grocer, 92 Chatham, h. do.
- Schleifer John jr. clerk, 92 Chatham, b. do.
- Schleiffarth Ferdinand, confectioner, 316 State, house 72 Reynolds
- Schleiss Charles, laborer, house 56 Delevan
- Schleiss Charles H. peddler, h. 24 Scrantom
- Schleiss Louisa, tailorress, boards 24 Scrantom
- Schlelo Joseph, cigarmaker, 48 Exchange, b. Reed House
- Schlenk Charlotte, dressmaker, b. 17 Wilson
- Schlenk George, framemaker, 38 Gorham, house 17 Wilson [Hollister n. Landing
- Schlenker Jacob, shoemaker, 4 Allen, bds.
- Schlenker John, peddler, house 48 Hollister
- Schlenker Thomas, machinist, b. 48 Hollister
- Schlenker William, tinsmith, 48 North av. bds. 48 Hollister
- Schlereth Charles, mason, house 110 South av.
- Schlereth Valentine, rag picker, house 107 South avenue
- Schlereth Valentine, deceased, April, 1875
- Schleyer Charles, butcher, h. 13 Leopold
- Schleyer John, house 2 Lancaster
- Schleyer Joseph, market, 136 East Main, h. 20 Lancaster
- Schleyer Joseph jr, clerk, 136 E. Main, h. 53 Joiner [b. 2 Lancaster
- Schleyer Joseph 2d, butcher, 132 E. Main,
- Schleyer Nicholas, butcher, 77 East av. b. do.
- SCHLEYER PETER,** market, 77 East av. house 14 East.—See page 556
- Schlicht Christian, carpenter, house 7 Kelly
- Schlicht Paul J. clerk, Roch. German Ins. Co. West Main cor. Fitzhugh, b. 7 Kelly
- Schlick Adolph F. bookkeeper, 149 Exchange, boards 60 South St. Paul
- Schlick George, removed to Canandaigua
- Schlick Josephine, domestic, 49 Lake avenue
- Schlickman John jr. tobacco worker, boards 91 Meigs
- Schlickman John, blacksmith, h. 91 Meigs
- Schlitzter Aquiline, tailor, h. 138 N. Clinton
- Schlitzter Frank A. tailor, bds. 138 N. Clinton
- Schlitzter Isador, grocer, 82 North avenue, house do.
- Schlitzter John (Saller & Schlitzter), house 34½ Ward
- Schlitzter Joseph, cutter, 25 Mill, h. 6 Joiner
- Schlitzter Joseph H. salesman, 23 E. Main, b. 41 Andrews [corner Andrews
- Schlitzter Juliana, widow, h. North Clinton
- Schlitzter Leo, grocer, 54 South St. Paul, house do. [at Irondequoit
- Schlitzter Leo A. saloon, 39 Andrews, house
- Schlitzter Valentine I. salesman, 53 E. Main, boards N. Clinton cor. Atwater
- Schloegel Matthias, shoemaker, 158 Plymouth avenue, house do.
- Schlomyansky Ephraim, peddler, b. 9 Cole
- Schlomyansky Jacob, peddler, house 9 Cole
- Schlösser Catharine, widow, bds. 129 Wilder
- Schlösser John, laborer, house 273 Brown
- Schlösser Michael, removed to Ashley, Ill.
- Schlösser Peter, laborer, boards 129 Wilder
- Schlottman John, laborer, house 129 Meigs
- Schlottmann Charles, laborer, h. 13 Almira
- Schmalholz Barbara, widow, house North Clinton near Norton

Schmalholz John, finisher, 38 Gorham, house North Clinton near Blumenthal
 Schmalz Leopold, engineer, Brackett House, house 57 Joiner
 Schmalz, see Small
 Schmanke Ferdinand, removed to Kansas
 Schmanke Frank, laborer, house Scrantom near North Clinton
 Schmanke Frederick A. tailor, 79 State, house avenue C corner Conkey avenue
 Schmanke Henry, mason, house 4 Maria
 Schmanke John, laborer, h. 27 McDonald av.
 Schmering John B. engineer, 22 West av. h. 18 Trowbridge
 Schmeuser Henry, cabinetmaker, 117 North Water, house Clifford near N. Clinton
 Schmid Adolph, sign painter, bds. 58 Weld
 Schmid Andrew, boiler maker, Platt corner Kent, house 106 Frost avenue
 Schmid Anthony, laborer, 8-Hill, h. 41 Maple
 Schmid Benson, carver, boards 41 W. Maple
 Schmid Hugo, butcher, house North avenue opposite Clifford [house 45 Martin
 Schmid John P. foreman, River n.N. St. Paul,
 Schmid Joseph, bootmaker, 7 S. St. Paul, h. 58 Weld [Maple
 Schmid J. Michael, whipmaker, bds. 41 West
 Schmid Louis, teamster, People's Mills, bds. Champion cor. Leavenworth alley
 Schmid Robert, laborer, house 22 Rhine
 Schmid Wm. carver, 2 Hill, b. 106 Frost av.
 Schmiddiel Andreas, laborer, h. 44 Hebard
 Schmidt Adam, laborer, house 281 N. Clinton
 Schmidt August, shoemaker, h. 2 Campbell
 Schmidt Charles, tailor, boards 61 Weld
 Schmidt Charles, laborer, house First avenue near Central park [Pennsylvania av.
 Schmidt Christian, laborer, h. First av. near
 Schmidt Christian, shoemaker, 73 Exchange, house Clifford near St. Joseph
 Schmidt Christian, shoemaker, h. 1 Hoeltzer
 Schmidt Christoph, student, Roch. Theological Seminary, boards 118 Alexander
 Schmidt Conrad tailor, h. 10 University av.
 Schmidt Conrad, house Norton n. N. Clinton
 Schmidt Dominickus, shoemaker, 79 North Water, house 68 West Maple
 Schmidt Edward, tailor, 60 Smith's block, house 13 Elizabeth place [Thomas
 Schmidt Frederick, laborer, h. Weeger near
 Schmidt Frederick, carpenter, h. 2 Putnam
 Schmidt Frederick, shoemaker, 5 Maria. l. do.
 Schmidt Jacob, shoemaker, 77 N. Water, h. 20 Hope
 Schmidt John, peddler, house 240 St. Joseph
 Schmidt John, potter, 97 Scio, house do.
 Schmidt John, tailor, boards 6 Kirk
 Schmidt John, laborer, house 9 Vose
 Schmidt John A. baker, 80 Hudson, bds. do.
 Schmidt John G. blacksmith, 3 Canal, house 110 Campbell [16 St. Joseph
 Schmidt John G. jr. turner, 135 N. Water, b.
 Schmidt John George, woodturning, 135 N-Water, house 16 St. Joseph
 Schmidt John M. market, 101 Scio, house do.
 Schmidt Louis, laborer, 16 Stone, h. Alexander near Central av. [137 Campbell
 Schmidt Michael, shoemaker, 51 Front, h.

Schmidt Nicholas, basketmaker, h. 61 Weld
 Schmidt Otto F. deceased April, 1876
 Schmidt Peter, house 24 Edward
 Schmidt Philip, laborer, b. Weeger n. Thomas
 Schmidt Philip, laborer, house N. Clinton near Vernon park
 Schmidt Rosa J. widow, house 18 Weld
 Schmidt Rudolph, optician, boards 18 Weld
 Schmidt William, stonecutter, boards 150 South St. Paul [Paul, h. 48 Tappan
 Schmidt William, hairdresser, 2 North St.
 Schminke Christopher, cabinetmaker, 184 State, h. 41 Chatham [b. 41 Chatham
 Schminke George C. upholsterer, 184 State,
SCHMITT ADAM, boots and shoes, 162 State c. Centre, house do.—See page 542
 Schmitt Andrew, laborer, house 90 Orange
 Schmitt Annie, domestic, bds. 54 N. Union
 Schmitt Anton, blacksmith, Brown c. Jones, house 104 Campbell [Mill, h. do.
 Schmitt Blasius, propr. Tremont House, 81
 Schmitt Cæsar, laborer, 23 N. Water, house North avenue near Norton
 Schmitt Casimer, laborer, h. 131 Broadway
 Schmitt Ernest, laborer, boards 88 Saxton
 Schmitt George M. machinist, 124 Mill, h. 53 Sellinger
 Schmitt John, shoemaker, house 96 Jay
 Schmitt John, blacksmith, 12 S. Water, house First avenue near Bay
 Schmitt John, tailor, 45 Vienna, house do.
 Schmitt Joseph, laborer, bds. 131 Broadway
 Schmitt Joseph A. laborer, boards 88 Saxton
 Schmitt Joseph M. druggist, 108 North av. h. 6 Weld
 Schmitt Julius, physician, 138 E. Main, h. do.
 Schmitt Julius, tailor, 79 State, h. 40 Baden
 Schmitt Leopold (*Hicks & Schmitt*), house 69 Herman [82 Lime
 Schmitt Lorenzo, flagman, Orange st., house
 Schmitt Magdalena, widow, house 89 St. Joseph [149 Tremont
 Schmitt Michael, stonecutter, 22 West av. h.
 Schmitt Michael, laborer, house 88 Saxton
 Schmitt Nicholas, cabinet maker, Aqueduct, house Bay near Miller
 Schmitt Theodore, baker, Grape cor. Campbell, boards do. [h. do.
 Schmitz Theodore, carpenter, 24 Franklin,
 Schmuck Anthony, porter, 81 E. Main, bds. 25 Clinton place
 Schmuck Xavier, potter, 97 Scio, boards do.
 Schmunke John, laborer, 139 North St. Paul, house 27 McDonald avenue
 Schmucker John, laborer, Brown cor. Jones, house 89 West Maple
 Schmutz Frederick, butcher, house Bay cor. Ackerman
 Schnackel Charles R. T. tailor, h. 11 Baden
 Schnackel Sophia, widow, house 39 Hoeltzer
 Schnarr Emily, clerk, 52 State, boards 198 North Clinton
SCHNARR HENRY H. & BRO. (J. Schnarr), mineral water manufs. 114 N. Clinton, house 35 Hand.—See page 566
 Schnarr John (*H. H. Schnarr & Bro.*), bds. 35 Hand [Lake av.
 Schnechenberger Christian, laborer, bds. 106

A. R. PRITCHARD & LIKLY,

FINE MOROCCO SATCHELS,
 No. 78 STATE STREET.

- Schnechenberger Jacob, hostler, 322 State, boards do.
- Schneck Jacob G. cooper, boards 74 Joiner
- Schneckel Christopher, blacksmith, 170 St. Joseph, house do.
- Schneibel Bernhard, removed to Lyons
- Schneider Abraham, baker, h. 221 E. Main
- Schneider Adam, laborer, bds. 41 Nassau
- Schneider Adam, mason, h. Hudson n. Norton
- Schneider Anna, widow, house 75 Kelly
- Schneider Anthony, gardener, h. Jennings near North avenue
- Schneider Bennett, laborer, house 3 Bay
- Schneider Catharine, midwife, h. 57 Nassau
- Schneider Catharine, widow, boards 4 Hope
- Schneider Catharine, widow, bds. 8 Hamilton place
- Schneider Christian, laborer, h. 46 Sanford
- Schneider Christian, removed from city
- Schneider Christopher, scavenger, house 90 Chatham
- Schneider Fiedel, shoemaker, h. 85 Whitney
- Schneider Frederick, saloon, 143 Mill, h. do.
- Schneider Frederick Wm. printer, 82 West Main, house 8 Hamilton place
- Schneider George, butcher, 61 Frances, h. Reynolds corner Cady
- Schneider George, porter, house 60 Smith
- Schneider Jacob, peddler, bds. 26 Galusha
- Schneider John, mason, h. Hudson n. Norton
- Schneider John, baker, 147 E. Main, h. 242 do.
- Schneider John B. laborer, house 3 Bay
- Schneider Joseph, well digger, h. r. 11 Cole
- Schneider Joseph, gardener, h. 47 Scrantom
- Schneider Joseph A. printer, b. 47 Scrantom
- Schneider Louis, laborer, house 57 Nassau
- Schneider Michael, 91 State, bds. 60 Smith
- Schneider Michael, teamster, 3 N. Water, h. 6 West Maple [Hudson]
- Schneider Nicholas, driver, h. Bernard near
- Schneider Peter, tailor, house 32 Weld
- Schneider Philip, teamster, h. 27 Baden
- Schneider Rudolph, shoemaker, house 107 Campbell
- Schneider Stephen, asst. pastor St. Joseph's church, 24 Franklin, boards do.
- Schneider William, laborer, house 92 Hunter
- Schneider, see Snyder and Snider
- Schnell Adam, cutter, 46 Mill, h. 16 Almira
- Schnell Albert, grocer, 40 Caroline, b. 38 do.
- Schnell Anthony, engineer, bds. Mt. Vernon avenue near Whitmore park
- Schnell Henry J. planer, h. 10 Whitmore pk.
- Schnell Mary, widow, house Mt. Vernon av. near Whitmore park
- Schnell Mary, widow, house Caroline n. Mt. Vernon av.
- Schnell, see Snell [seph]
- Schnellbach Barbara, widow, h. 28 St. Joseph
- Schnepf Chas. F. sashmaker, Fiske's bldgs. boards 63 Weld
- Schnepf George J. trunkmaker, b. 63 Weld
- Schnetzler G. Peter, quarryman, h. 13 Galusha
- Schnitzer Joseph, blacksmith, bds. 32 Front
- Schnorr Jacob, grocer, 1 Baden, house do.
- Schoch Elias, teamster, b. North av. c. Caspar
- Schoch Mary A. widow, h. North av. cor. Caspar
- Schoeffel Frank A. saloon, 11 S. St. Paul, h. 6 Wilson [6 S. Clinton]
- Schoeffel John B., Rochester Opera House, b.
- Schoeffel Mary, widow, house 16 Scio
- Schoeller George, optician, 179 N. St. Paul, house 35 Catharine [do.]
- Schoellhorn Ludwig, drygoods, 160 Jay, h.
- Schoelz Frederick, fancy goods, 188 North Clinton, house do.
- Schoemann Anton, laborer, house 103 Magne
- Schoen Albert, hairdresser, 100 East Main, h. 41 Stone [Campbell]
- Schoen Andrew, shoemaker, 4 Allen, h. 85
- Schoen August, hairdresser, 100 E. Main, b. 41 Stone
- Schoen Catharine, widow, bds. 85 Campbell
- Schoen Emeram, laborer, Erie railway repair shop, house 108 Saxton
- Schoen Mary, widow, h. Genesee c. Clifton
- Schoen Matthias, cutter, 75 North Water, h. 86 Wilder
- Schoen William, cabinet maker, 71 North St. Paul, house 65 Smith
- Schoenberg Moritz, reporter, Beobachter, 23 W. Main, h. 52 Vienna [188 Meigs]
- Schoenemann Henry, turner, Aqueduct, h.
- Schoenfelder Arno N. carriage painter, 35 S. St. Paul, boards 53 Monroe avenue
- Schoenfelder August, hair dresser, 53 Monroe avenue, house do.
- Schoenfeldt Frederick, laborer, 87 N. Water, house 31 Weeger
- Schoenfeldt William, tanner, h. 1 Drayton
- Schoenweitz Barbara, widow, h. 63 W. Maple
- Schoenweitz Barbara Miss, tailoress, 63 W. Maple, boards do.
- Schoenweitz Christopher, dec'd Jan. 14, 1876
- Schoenweitz John N. brakeman, bds. 63 W. Maple [56 Cypress]
- Schoenweitz Joseph, shoe cutter, 55 Mill, h.
- Schoenweitz Josephine, boards 56 Cypress
- Schoenweitz Theresa M. stitcher, boards 63 West Maple [Clinton, h. 54 Scrantom]
- Schoepfel Charles, boots and shoes, 242 N. Water, house 5 Hawkins [Orchard]
- Schoepper Charles, music teacher, house 106
- Schoffnagel Alexius, gardener, 24 Franklin, boards do.
- Schofield Alzina R. house 52 Pearl
- Schofield Eliza, widow, house 52 Pearl
- Schofield Edward S. boards 27 Park avenue
- Schofield Erwin J. painter, 14 Stone
- Schofield George, ticket agent, 92 Mill, h. 30 Andrews
- Schofield Samuel, house 27 Park avenue
- Scholastica Sister, teacher, Immaculate Conception school, bds. Jay cor. Frank
- Scholl Jacob, stone cutter, 54 Fitzhugh, h. 54 Gregory
- Scholl Philip, wagon maker, h. 34 Munger
- Schomburg Hugo, saloon, 42 N. Clinton, h. do.
- Schomer Susan, widow, house 185 Jay
- Schomer Matthias, clerk, 108 Orange, boards 185 Jay [42 do.]
- Schooley Edward, grocer, 46 Monroe av. h.
- Schooley Edward M. gas fitter, h. 42 Monroe avenue

Schooley James H. boards 42 Monroe avenue
 Schooley Richard H. lawyer, 159 Powers' bldgs. boards 42 Monroe avenue
 Schoonmaker John J. carpenter, b. 92 Pearl
 Schopp Henry, tailor, h. 164 North Clinton
 Schopp Martin J. tailor, bds. 164 N. Clinton
 Schott Paul, driver, boards 1 Cataract
 Schoup Conrad, butcher, house 27 Delevan
 Schoupp Anthony, butcher, h. 161 Pinnacle avenue
 Schout Abram, boxmaker, bds. 50 Hanover
 Schout Daniel, foreman, 184 State, house 43 Baden
 Schout Jacob, laborer, boards 50 Hanover
 Schout William, varnisher, 184 State, house 50 Hanover
 Schowalter Rachael, widow, house 3 Flower
 Schrage Wm. G. removed to Titusville, Pa.
 Schramm Frederick E. tailor, h. 26 Joiner
 Schrank Christina, house 45 Weld [av.
 Schrank Frank, teamster, h. Bay n. Second
 Schrank Lorenz, shoemaker, 14 Weld, h. do.
 Schreck Adolph, grocer, 127 Scio, house do.
 Schreck George, cabinetmaker, 69 N. St. Paul, boards 8 Nassau [Tyler
 Schreiber Andrew, porter, 36 State, house 25
 Schreiber Fred, removed to Canandaigua
 Schreiber Frederica, widow, h. 11 Baden
 Schreiner Barney J. machinist, Court corner Stone, boards 112 Orange
 Schrier George, soap maker, 27 N. Water, h. W. Maple c. Childs [Maple c. Childs
 Schrier George J. hairdresser, 127 State, b. W.
 Schrier Joseph, shoemaker, house 42 Orange
 Schrimml Chrisence, house rear 50 Orange
 Schriner Geo. carpenter, house 112 Orange
 Schriner John B. tailor, 10 W. Main, b. 112 Orange [42 Scrantom
 Schroedel August, grocer, 9 Hawkins, house
 Schroeder Bernard, laborer, house Bay near Ackerman
 Schroeder Charles, laborer, boards 44 Baden
 Schroeder Charles F. rubber worker, 141 N. Water, boards 66 Thomas
 Schroeder Chris, laborer, h. 53 North avenue
 Schroeder Christopher, laborer, h. Thomas corner Alphonse
 Schroeder Fanny, widow, boards 7 Foechner
 Schroeder Frederick, deceased, 1875
 Schroeder Henry, porter, 80 E. Main, bds. 67 Nassau
 Schroeder John, laborer, boards 46 Hoeltzer
 Schroeder John, laborer, h. 74 North av.
 Schroeder Mary, domestic, b. Goodman near Ackerman
 Schroeder Morris, laborer, house 44 Baden
 Schroeder Sophia, widow, h. 46 Hoeltzer
 Schroettlen John, tailor, house 33 Herman
 Schroll Joseph, shoemaker, h. N. Clinton n. Norton [c. Adams, house do.
 Schroth Charles (H. & C. Schroth), Reynolds
 Schroth Henry (H. & C. Schroth), Reynolds c. Adams, house do.
 Schroth H. & C. market, Reynolds c. Adams
 Schroth Jacob, house 106 St. Joseph
 Schroth Jacob jr. market, 106 St. Joseph, h. 4 Baden [Joseph
 Schroth John, polisher, 136 Mill, b. 106 St.

Schroth John, butcher, house 27 Reynolds
 Schroth John, laborer, Brown cor. Jones, h. 9 Hoelfer
 Schubert Dora, widow, house 70 Reynolds
 Schubert Frederick, clerk, bds. 70 Reynolds
 Schubert Gustav, miller, People's Mill, bds. 143 Mill
 Schubert Lawrence, laborer, h. 35 Scrantom
 Schubert Magdalena, widow, h. 8 Vienna
 Schubert Sebastian, blacksmith, Brown's race n. Furnace, h. 152 Lyell [avenue
 Schubert Stephen, laborer, h. Hague n. West
 Schuchart Annie, widow, 53 St. Joseph
 Schuchart Christian, deceased, July 1875
 Schuchart Michael, tailor, 53 Smith's blk. h. 128 St. Joseph [b. 128 St. Joseph
 Schuchart Quinibert, cutter, 53 Smith's blk.
 Schue John, laborer, house 17 Munger
 Schue Libbie Miss, tailoress, bds. 17 Munger
 Schuebelin Christoph, removed to N. Y. city
 Schueler Alphonso N. tailor, b. 23 Leopold
 Schueler Joseph, tailor, house 23 Leopold
 Schueler Joseph jr. cutter, Mill c. Mumford, boards 23 Leopold [near Flower
 Schuessler Jacob, beer peddler, h. N. Clinton
 Schuey John A. saloon, 75 Exchange, h. do.
 Schuhknecht August, laborer, h. 1 Zimmer
 Schuhmacher Jacob, turner, Hydraulic bldgs. house 22 Wilson
 Schuhman George, tailor, 28 McDónald av. boards 43 Herman [house do.
 Schuhman Michael, shoemaker, 43 Herman
 Schuhmann Anna, widow, house 13 Baden
 Schuhmann Charles, driver, house 99 Meigs
 Schuhmann Joseph, deceased April, 1875
 Schuhmann Louis, barber, boards 13 Baden
 Schuhmann William, farmer, house 13 Baden
 Schuld Anna, widow, boards 33 Sellinger
SCHULER CHARLES F. bung manuf. and turner, 131 N. Water, h. 4 Sellinger. —See page 592 [136 Wilder
 Schuler Gabriel, shoemaker, 121 Jay, house
 Schuler Nicholas, coremaker, 8 Hill, boards Childs opp. Orange
 Schulik Cornelius, cartman, h. 43 Charlotte
 Schulte Hermann, tailor, 4 Mill, boards 5 Leopold [Hudson n. Norton
 Schultheis Henry, laborer, 166 State, house
 Schultheis Mary, tailoress, 48 Martin, boards 336 N. Clinton [ton n. Flower
 Schultheis Nicholas, mason, house N. Clin-
 Schultheis Phillipena, tailoress, boards N. Clinton n. Flower [av. b. 168 do.
 Schultz August, glass blower, 178 Plymouth
 Schultz Charles, laborer, h. Hudson n. Norton
 Schultz Charles, baker, 134 N. St. Paul, h. do.
 Schultz F. Louis, hairdresser, 113 St. Joseph, house do.
 Schultz Henrietta, widow, boards 3 Joiner
 Schultz Henry, cooper, Magne opp. Walnut, house 58 Smith [b. Hudson n. Norton
 Schultz Henry, sawyer, River n. N. St. Paul,
 Schultz John, laborer, house 35 Mark
 Schultz John, laborer, house 28 Mark
 Schultz John, laborer, house 11 Helena
 Schultz John jr. laborer, house 28 Mark
 Schultz Louis C. tinsmith, 70 North av. h. do.
 Schultz Louis, tailor, house 75 Herman

Schultz Louis H. driver, bds. 102½ E. Main
 Schultz Otto L. music teacher, b. 39 Atwater
 Schultz Philip, machinist, 136 Mill, house
 22 Gorham [do.
 Schultz William L. tinsmith, 70 North av. b.
 Schultze Caroline, widow, house 11 King
 Schultze Frederick, blacksmith, h. 10 Oakland
 Schultze Mary, tailoress, boards 11 King
 Schultze Theresa, tailoress, boards 11 King
 Schulz Christopher C. agent. b. 127 South av.
 Schulz Conrad (*Schulz & Hickey*), boards 127
 South avenue
 Schulz Emma C. boards 74 Hickory
 Schulz Frederick, painter, house 4 Huron
 Schulz Frederick F. carpenter, h. 74 Hickory
 Schulz George C. mason, house 127 South av.
 Schulz Henry, laborer, house 38 Cypress
 Schulz John G. tailor, house 58 Spring
 Schulz & Hickey (*C. Schultz and E. T. Hickey*),
 cigar makers, rear 46 South av.
 Schulze Albert K. W. sashmaker, ft. of N.
 Water, h. 31 Alexander [b. 278 North
 Schulze Charles E. boxmaker, 3 Aqueduct,
 Schulze Frederick, carpenter, h. 278 North
 Schumacher Charles, gardener, East av. cor.
 Alexander, h. Alexander opp. Asylum
 Schumacher Otto, coachman, bds. Alexander
 opp. Asylum [h. 49 Orange
 Schuman George, baker, Grape c. Campbell,
 Schuman Michael, cabinetmaker, 69 N. St.
 Paul, h. Alexander n. Central park
 Schuster George M. shoemaker, house 255
 North Clinton
 Schuster Michael, framemaker, h. 27 Rauber
 Schuszler Jacob, beer peddler, house North
 Clinton near Flower
 Schuth Henry, laborer, house 2 Sellinger
 Schutt Charles F. peddler, house 41 Hanover
 Schutt Helmuth, cabinetmaker, 7 N. Water,
 house 24 Ward
 Schutte Alphonso V. removed to N. Y. city
 Schutte John C. curled hair, 25 Vienna, h. do.
 Schutte John L. clerk, 73 Mill, b. 16 Franklin
 Schutte Joseph, overseer of poor, 63 Front,
 h. 16 Franklin [Water, b. 16 Franklin
 Schutte Joseph jr. cabinetmaker, 133 North
 Schutte Theodore, laborer, house 29 Sanford
 Schutte William F. boards 25 Vienna
 Schutter Bron, varnisher, 7 North Water, h.
 50 St. Joseph [E. Main, h. 72 Weld
 Schutter Ernestus D. H. photographer, 81
 Schutter Lisette Mrs. midwife, house 50
 St. Joseph
 Schutz Joseph, tailor, house 17 Shamrock
 Schuyler Benjamin F. (*Morgan & Schuyler*),
 55 E. Main, house 113 Alexander
 Schuyler Frederick, laborer, bds. 3½ Ward
 Schuyler John, machinist, Brown's race near
 Furnace, boards 3½ Ward
 Schuyler Vanransler, machinist, h. 3½ Ward
 Schwaab Joseph, lastmaker, Shawmut bldg.
 h. Clifford n. N. Clinton
 Schwab Bernhard, pumpmaker, Whitney c.
 Smith, h. do.
 Schwab Chas. tailor, h N. Clinton n. Flower
 Schwab Ferdinand, moulder, 20 Court, bds.
 N. Clinton n. Flower
 Schwab Ferdinandus, mason, h. 340 N. Clinton

Schwab Goodhard, grocer, 128 S. St. Paul,
 house do.
 Schwab Jane, widow, boards 117½ E. Main
 Schwab John, pumpmaker, Smith c. Whit-
 ney, house do.
 Schwab Joseph, house 59 Whitney [h. do.
 Schwab Rose Mrs. grocer, Whitney c. Smith,
 Schwab Nicholas (*Ernst & Schwab*), 19
 North avenue, house 21 do.
 Schwabach Caspar, laborer, h. 62 Munger
 Schwabach Clara, tailoress, bds. 62 Munger
 Schwabach Simon, removed from city
 Schwan Paul, carpenter, 23 Gorham, h. St.
 Joseph near Clifford [n. city line
 Schwartz George, laborer, house N. Clinton
 Schwartz Elizabeth, tailoress, b. N. Clinton
 near city line
 Schwartz George M. saloon, 219 North Clin-
 ton, house do. [avenue
 Schwartz Gertrude, widow, h. 19 McDonald
 Schwartz John, shoecutter, h. 18 Catharine
 Schwartz John, laborer, boards 205 State
 Schwartz Joseph H. shoemaker, 77 North
 Water, boards 19 McDonald avenue
 Schwartz Martin, shoemaker, 7 S. St. Paul,
 h. N. Clinton near Hollenbeck
 Schwartz Samuel L. policeman, City Hall,
 house 221 Jay [McDonald av.
 Schwartz Valentine P. shoemaker, boards 19
 Schwartz Wendel, hostler, 262 State, bds. do.
 Schwarz Bros. (*M. & H. Schwarz*), clothing,
 63 Mill [40 N. Frances
 Schwarz George, tinsmith, 90 East Main, h.
 Schwarz Henry (*Schwarz Bros.*), house 19
 Clinton place [N. St. Paul
 Schwarz Morris (*Schwarz Bros.*), house 40
 Schwarz Peter, coal, house 73 Adams
 Schweickhardt Joseph D. machinist, 111 Ar-
 cade, house 39 Atwater [Chatham
 Schweiger George, wagonmaker, boards 122
 Schweitzer Edward, gilder, 43 N. Water, b.
 281 Brown [Jones, h. 281 Brown
 Schweitzer John, patternmaker, Brown cor.
 Schweizer Simon, farmer, h. North av. near
 Jennings [av. h. 37 Hill
 Schweizer Theodore, stonecutter, 22 West
 Schwendler Elizabeth, saloon, 1 Wilder, h. do.
 Schwendler Jacob G. clerk, 100 Railroad av.
 boards 1 Wilder
 Schwenzer Gottlieb, laborer, house 30 Cole
 Schwert John, laborer, h. 188 Pinnacle av.
 Schwietering John Frank, mason, house La-
 force park near N. Clinton
SCHWIKERT FRANK, billiard table
 manuf. 12 S. Water, and (*Ingalls &*
Schwikert), house 19 Buchan park.—*See*
page 596
 Schwind Frank, shoemaker, River n. N. St.
 Paul, boards N. Clinton n. Blumenthal
 Schwind Ignatz, baker, 45 Andrews, h. 2
 Union alley [ton, n. Blumenthal
 Schwind Jacob, shoemaker, house N. Clin-
 Schwing John, blacksmith, 3 Canal, house
 87 Smith [house do.
 Schwing Wm. grocer, Orange c. Whitney,
 Schwingel Catharine, widow, h. 52 N. Union
 Schwingler John P. bakery, 9 Delevan, h. do.
 Schwien Anna, widow, h. Goodman n. Bay

HENRY C. WISNER,

KEROSENE CHANDELIERS, BRACKETS, AND LAMPS--No. 33 STATE STREET.

Schwoerer Jacob, cornices, boards 120 Front
 Scobell Frederick Mrs. house 94 State
 Scofield Erwin J. painter, b. 20 Hamilton pl.
 Scofield Henry C. mats, 110 State, house 40
 Frank [20 Hamilton place
 Scofield Henry L. shoemaker, 111 State, bds.
 Scofield Jane Mrs. landress, house 25 Platt
 Scofield Mary, widow, boards 139 West av.
 Scofield Shadrack, house 20 Hamilton place
 Scofield Warren D. salesman, 53 E. Main, h.
 35 Frost avenue [25 Platt
 Scofield Wm. H. bartender, 170 State, boards
 Scollard Betsy, widow, boards 2 Emmett
 Scollard Hanora, boards 51 Saxton
 Scollard Michael, switchman, house Murray
 near Lyell
 Scollick Joseph W. osteologist, 2 College av.
 h. Arlington n. University avenue
 Scott Agnes, stitcher, boards 100 Saxton
 Scott Alexander, musician, h. 248 Exchange
 Scott Bridget, widow, house 63 Manhattan
 Scott Charles, baker, house 12 Waverley pl.
 Scott Edwin B. clerk, boards 96 Tappan
 Scott Elizabeth, stitcher, boards 100 Saxton
 Scott Henry L. painter, house Goodman n.
 Monroe avenue
 Scott Isabell, widow, h. 19 University avenue
 Scott Jacob D. car dispatcher, house 6 Jones
 Scott James, plumber, 25 Exchange, boards
 34 Gibbs
 Scott James, planemaker, house 96 Tappan
 Scott James H. saw-etcher, bds 96 Tappan
 Scott James M. R. B. cutter, h. 1 Edmonds
 Scott Jennie Miss, seamstress, h. 32 Asylum
 Scott John, miller, 1 W. Main, b. York House
 Scott John, laborer, house 48 Bolivar
 Scott John C. S. (*Waring & Scott*), E. Main
 cor. Goodman, bds. 315 East Main
 Scott John G. removed from city
 Scott Margaret Mrs. boards 15 Lyell
 Scott Martha, seamstress, house 100 Saxton
 Scott Mary, widow, h. Huntington n. North
 Scott Mary J. widow, house 194 Exchange
 Scott Thomas A. compositor, h. 1 Marietta
 Scott Thomas H. pattern maker, h. 54 Platt
 Scott Walter, paver, house 47 Delevan
 Scott William, gardener, bds. Goodman n.
 Monroe av. [Furnace, h. 17 Spencer
 Scott William H. moulder, Brown's race n.
 Scott William H. removed from city
 Scott William W. bookkeeper, 128 Powers'
 bldgs. b. 10 Joslyn pk. [Washington
 Scouten Chauncey, carpenter, house 43 S
 Scouten Mary J. Mrs. boards 93 Lake avenue
 Scrantom Ardelia (*Scrantom & Co.*), boards
 35 Hunter [boards 1 Whitney place
 Scrantom Edwin, auctioneer, 26 East Main,
 Scrantom Elbert H. (*Scrantom & Wetmore*),
 house 7 East
 Scrantom Elizabeth W. dec. March 4, 1876
 Scrantom Francis E. carrier, Post Office, bds.
 7 Matthews
 Scrantom Hamlet D. boards Osburn House
 Scrantom Mary J. boards 315 East Main
 Scrantom Theodore E. agent, Hunter cor.
 Olean, house 35 Hunter
 Scrantom & Wetmore (*E. H. Scrantom and*
L. G. Wetmore), bookstore, 12 State

Scrantom & Co. (*A. Scrantom and F. Whit-*
tlesey), lumber, Hunter cor. Olean
 Sculley Annie, weaver, boards 20 Bolivar
 Sculley Carrie B. dressmaker, b. 20 Bolivar
 Sculley Catharine, widow, house 20 Bolivar
 Sculley John F. bookkeeper, b. 20 Bolivar
 Sculley Julia T. weaver, boards 20 Bolivar
 Sculley Mary, domestic, bds. 83 East avenue
 Sculley Patrick, laborer, Erie railway repair
 shop, house 95 Adams
 Seabert Augusta, house 4 North York
 Seafried Rosamus, laborer, bds. r. 76 Mt.
 Hope avenue
 Seagal Julia, widow, house 386 Brown
 Seakerest Rudolph, laborer, h. 38 Gregory
 Seaman Alfred P. house 20 Chestnut
 Seaman George B. salesman, 19 Mill, boards
 20 Chestnut
SEAMAN STEPHEN, grocer, 116 E. Main,
 house 114½ do.—*See page 556*
 Search Charles M. boards 21 Chatham
 Search Edward, agent, house 20 Rowley
 Search Elizabeth M. widow, h. 21 Chatham
 Search George E. clerk, 25 West Main, house
 5 North Union [Rowley
 Search Wm. J. clerk, 208 E. Main, house 20
 Searing Anna H. Miss (*Dolly & Searing*), phy-
 sician, 30 East avenue, house do.
 Searing Samuel H. house 34½ Prospect
 Searl Albert, blacksmith, boards 6 Howell
 Searle Edward B. blacksmith, h. 6 Howell
 Searle Herman S. agent, house 73 Martin
 Searle Malvina, teacher, boards 6 Howell
 Searle Mariette L. widow, boards 4 Vine
 Searle Nettie L. Miss, boards 4 Vine
 Searles Anna Mrs. widow, boards 33 Troup
 Searles William, shoemaker, Andrews corner
 N. Water, h. 55 Saratoga avenue
 Searles Wm. H. division engineer, State
 canal, 153 Powers' bldgs. house 132 Al-
 exander
 Seatree Wm. florist, boards 169 East Main
 Seaver Allen W. salesman, 93 State, boards
 146½ West Main
 Sebastian Sister, teacher, bds. Jay cor. Frank
 Sebree Leroy E., U. S. weather observer, 213
 Powers' bldgs. bds. 27 North Clinton
 Secord Augus, carpenter, b. 33 Wadsworth
 Sedgwick Stephen D. carpenter, 15 Jay, h. do.
 Sedgwick Wm. carpenter, house 60 Allen
 Sedgwick Wm. S. student, boards 60 Allen
 See Rosa Miss, boards 78 Tappan
 Seeber Barbara, widow, house 51 Wilder
 Seeber Mary C. widow, h. Ackerman n. Bay
 Seed Thomas, carpenter, West end Court st.
 bridge, house 16 Broadway
 Seel Adam, grocer, 622 West avenue, h. do.
 Seel Charles P. removed to Fort Wayne, Ind.
 Seel Christian, grocer, 70 Jay, h. 27 Magne
 Seel Christian jr. 70 Jay, boards 27 Magne
 Seel Conrad, cooper, 1 St. James park, house
 at Gates
 Seel John A. grocer, 12 Lake avenue, h. do.
 Seeley Charles, boards 11 Rowley
 Seeley Edward D. bookkeeper, 11 W. Main,
 house 188 Monroe avenue
 Seeley Isaac, gardener, h. Culver c. Webster
 road

- Seeley J. Edwin, physician, 117 Plymouth avenue, house do.
- Seeley Samuel, mason, house 11 Rowley
- Seeley Susan B. widow, boards 28 Fitzhugh
- Seelman Agnes, widow, house 22 Scrantom
- Seelman George, shoemaker, 79 N. Water, h. Alphonse cor. Henry
- Seelman John, tailor, boards 22 Scrantom
- Seelman Joseph, laborer, 8 Hill, boards 22 Scrantom [19 Sheridan pk.
- Seelman Valentine, shoemaker, 15 Mill, h.
- Seelos Charles, mason, house 48 Orange
- Seelos F. Peter, hostler, 83 Front, house do.
- Seelos John, bartender, 40 Orange, bds. do.
- Seely Frederick C. grocer, 41 Monroe av. b. 53 Chestnut [6 Cliff
- Seely Lawrence, miller, Irving Mills, house
- Seely Mason G. (*Seely & Edgar*), 6 State, h. 53 Chestnut
- Seely Michael, mason, boards 143 Mill
- Seely William, stonecutter, 22 West avenue, house 69 West Maple [tailors, 6 State
- Seely & Edgar (*M. G. Seely and M. Edgar*),
- Seely Charles W. clerk, 62 State, bds. 186 East Main
- Seelye John, boards 40 Chestnut [Troup
- Seelye J. Edwin, paperhanger, h. 30 West
- Seelye Ogden, clerk, 202 State, bds. 32 Oak
- Seemann John, laborer, house 43 Hoeltzer
- Segar Asa, machinist, house 57 Frank
- Seger Caspar, teamster, h. Henrietta avenue near Pinnacle avenue
- Seger Dillmann, teamster, house 61 Gregory
- Seger George, laborer, house 201 Scio
- Seger Geo. jr. butcher, 140 Hudson, bds. do.
- Seger Jacob, laborer, h. Henrietta avenue near canal
- Seger John, laborer, boards 61 Gregory
- Sehm Dora, widow, house Bay n. Goodman
- Sehm Frank, laborer, 22 S. St. Paul, boards Goodman near Bay
- Sehm Geo. laborer, house Goodman n. Bay
- Sehm John, shoemaker, Goodman near Bay, house do. [Goodman
- Sehm John jr. nurseryman, house Bay near
- Seidel Emil, optician, 179 North St. Paul, h. 12 Vienna
- Seidel Julius F. clergyman, h. 33 Concord av.
- Seidel Otto, clerk, boards 33 Concord av.
- Seidel Wm. J. agent, house 26 North av.
- Seidler Irvin, hairdresser, 1 Corinthian Hall bldg. house 64½ Kirk
- Seidwant Adam, tailor, boards 8 Holland
- Seidwant Anthony, shoemaker, house 71 Chatham
- Seidwant David, shoemaker, h. 8 Holland
- Seif Joseph, shoemaker, house 60 Kelly
- Seifried Christian, laborer, house Goodman near Bay [h. Irondequoit
- Seifried Christopher, laborer, State c. Centre,
- Seifried Edward V. clerk, 13 West Main, b. East Main cor. North Union
- SEIFRIED FERDINAND & CO. (C. W. Kenniny)**, hardware, 13 West Main, h. East Main cor. N. Union.—*See page 630*
- Seifried Fred. J. bookkeeper, 13 West Main, boards E. Main cor. N. Union
- Seifried Peter, carpenter, h. 218 Pinnacle av.
- Seiler Anselm, laborer, house 228 St. Joseph
- Seiler Charles, machinist. Court cor. Stone, h. 26 Buchan park [b. 26 Buchan pk.
- Seiler Chas. W. machinist, Court cor. Stone,
- Seiler Christian, tailor, b. North av. n. Bay
- Seiler Hannah, seamstress, bds. 103 Orange
- Seiler Jacob, grocer, Campbell cor. Whitney, house do. [Whitney
- Seiler John, carpenter, bds. Campbell corner
- Seiler John, engineer, house 9 Wilder
- Seiler John T. conductor, h. 88 West Maple
- Seiler Joseph, carpet weaver, house North avenue near Bay [b. 26 Buchan pk.
- Seiler Peter W. lockmaker, Court c. Stone,
- Seiler William, potter, house 118 Scio
- Seiler William, hairdresser, 2 N. St. Paul, boards Front
- Seiles Johanna, domestic, bds. 76 N. Clinton
- Seiser August, mason, house Lewis n. Scio
- Seiser August jr. mason, bds. Lewis n. Scio
- Seiser Richard, shoemaker, h. 74 Martin
- Seith Frederick, optician, 179 N. St. Paul, house 8 McDonald avenue
- Seith George F. baker, 99 Hudson, house do.
- Seith Margaret, widow, b. 8 McDonald av.
- Seitz Adam, house 10 Herman n. St. Joseph
- Seitz Charles W. upholsterer, 7 N. Water, h. 8 Herman [St. Joseph n. Norton
- Seitz Ernest B. optician, 179 N. St. Paul, h.
- Seitz Frederick, gardener, Frost av. corner Olean, house 22 Bartlett
- Seitz Frederick C. carpenter, house 22 Kelly
- Seitz George, fireman, N. Y. C. R. R. bds. 10 Herman [12 Finney
- Seitz Lucas, wagonmaker, 249 East Main, h.
- Sejod Eliza, widow, house 21 Lancaster
- Selbert George, carpenter, boards 69 Kelly
- Selbert Jacob, shoemaker, 75 N. Water, h. 33 Vienna
- Selbert John, carpenter, house 69 Kelly
- Selbert John jr. carpenter, boards 69 Kelly
- Selbig Elizabeth, tailoress, boards 14 Clifford
- Selbig George, stove repairer, h. 14 Clifford
- Selbig Mary, tailoress, boards 14 Clifford
- Selden Arthur R. boards Grove place
- Selden George B. lawyer, 74 Powers' bldgs. boards Grove place
- Selden Henry R. lawyer, 74 Powers' bldgs. house Grove place
- Selden Louis L. house rear 29 Broadway
- Selden Samuel L. boards Grove place
- Seligman Isaac M. salesman, 10 Mill, h. 4 Leopold [St. Joseph
- Seligman Julius, cashier, 74 Mill, boards 8
- Selleman John, tailor, 71 Scrantom, b. 22 do.
- Sellew Walter A. pastor, Free Methodist church, house 75 Atwater [h. do.
- Sellinger George M. 2d, tailor, 27 Sellinger,
- Sellinger Geo. M. house 5 Sellinger
- Sellinger Geo. M. jr. moulder, 187 W. Main, house 38 Tremont [21 Sellinger
- Sellinger Michael, moulder, 187 W. Main, h.
- Sellmaier John, house 182 St. Joseph
- Sellmaier John jr. turner, 155 N. Water, h. 5 Alphonse
- Sellnor Charles, trunk maker, bds. 332 State
- Sellnow Frederic, shoemaker, 124 Front, h. 107 Champlain

HENRY C. WISNER,

CUT AND PRESSED GLASS TABLE WARE,
No. 33 STATE STREET.

Seltenmayer Edward, baker, 154 W. Main, house N. Clinton cor. Clinton place
 Selye DeVillo W. removed to Seattle, Washington Territory
 Selye Lewis, h. Lake av. n. Lake View park
 Semmel Charles, saloon, 183 North Clinton, house do. [17 Sophia
 Semple Andrew M. grocer, 4 W. Main, house
 Senke Frederic, piano tuner, 86 State, house 89 Chatham [Davis
 Senn Conrad, coach maker, 3 Canal, house 50
 Senteff Margaret, widow, h. 100 N. Clinton
 Senter Wm. H. removed from city
 Sentry Mary, widow, house Dean cor. John
 Seraphine Mary, Sister, St. Bridget's School, Hand, boards Jay c. Frank
 Sergisson Edwin F. pastor, Second Advent Christian Church, house 8 Edwards
 Sern John, laborer, h. N. Union n. German
 Serth Henry, teamster, house 19 Gregory
 Serth Jacob, teamster, 117 N. Clinton, house 19½ Gregory [boards do.
 Serth John, clerk, Reynolds corner Cady,
 Serth Philip, teamster, 117 N. Clinton, b. 19 Gregory
 Servatius John, painter, house 29 Galusha
 Servis J. Hillyard, conductor elevator, Powers' bldgs. boards 30 Elizabeth
 Servis M. Edward, b. Chili road n. city line
 Servis Silas A. (*Mattheus & Servis*), 86 West Main, boards 46 Smith's block
 Servis Wm. S. student, 100 Powers' bldgs. boards at Gates
 Servogel Jane, widow, h. Wolcott n. city line
 Servoss Adelia A. widow, house 4 Perkins
 Servoss Alfred W. agent, boards 4 Perkins
 Servoss Carl A. agent, 19 Mill, b. 4 Perkins
 Servoss Carrie E. teacher, Franklin School, No. 6, boards 4 Perkins
 Servoss Walter E. boards 4 Perkins
 Setwick Frank, finisher, 73 N. Water, bds. 5 Briggs' block
 Seuffert Barbara, widow, h. 242 N. Clinton
 Seuffert Frank M. boots & shoes, 78 Kelly, house do.
 Seumnicht Barbara Miss, tailoress, b. 41 King
 Seumnicht Geo. shoemaker, 14 N. Water. b. 41 Concord avenue
 Sevens Martha, bds. East av. c. Alexander
 Severance Charles R. painter, Centre c. State, house 83 Adams
 Severance Henry T. brakeman, h. 19 Asylum
 Severance Sarah E. widow, b. 11 Ambrose
 Seville Chadwick, engineer, 153 State, house 12 Galusha
 Seville James, carpenter, boards 12 Galusha
 Seville Robert H. printer, boards 12 Galusha
 Seward Consett, moulder, 20 Court
 Seward Jason W. house 114 Alexander
 Seward Sarah R. widow, bds. 106 Alexander
 Seward Wm. R. cashier, Bank of Monroe, 22 Exchange, house 106 Alexander
 Sexsmith Alice, dressmaker, bds. 10 Chatham
 Sexsmith Simon, house 10 Chatham
 Sexton Julia, dressmaker, boards 15 Jay
 Sexton Michael, helper, 3 Canal, h. 14 do.
 Sexton Wm. carpenter, b. Lewis n. N. Union
 Seybold Renold, saloon, 120 Front, h. do.

Seyler Jacob, 70 State, house 21 Scio
 Seyler Mary A. hat store, 70 State, h. 21 Scio
 Seymour Catharine C. widow, h. 38 Clifton
 Seymour Charles, bookkeeper, h. 9 Phelps av.
 Seymour Charles A. fireman, N. Y. C. R. R. boards 24 Spencer [h. 24 Spencer
 Seymour Christian, machinist, Brown c. Jones,
 Seymour George, laborer, boards 32 West av.
 Seymour George I. salesman, 36 State, b. 11 Fitzhugh [16 Chestnut park
 Seymour Henry F. clerk, 21 West Main, h.
 Seymour John H. carver, Jay c. Erie canal, boards 24 Spencer
 Seymour Martha T. widow, boards 47 Spring
 Seymour Nelson H. agent, house 49 Hudson
 Seymour Otis C. house 8 Charlotte [av.
 Seymour Philomine, stitcher, b. 107 Monroe
 Seymour Torrence, carpenter, h. 253 North
 Seymour Wm. machinist, boards 33 Spencer
 Seymour Wm. F. machinist, bds. 24 Spencer
 Shaal Charles, coachmaker, 3 Canal, house 11 Reynolds [27 Gorham
 Shackleton Edwin I. clerk, 117 N. Water, h.
 Shadders Wm. P. agent, 85 Front, house 38 North Union [36 S. Ford
 Shaddock Frederick, moulder, 8 Hill, boards
 Shadock Amelia, widow, house 52 Weld
 Shafer Frank G. brakeman, house 196 North
 Shafer Wm. butcher, bds. 111 Mt. Hope av.
 Shafer Wm. F. clerk, 13 State, boards 19 Chatham [house 60 Jones
 Shaffer Edward P. engineer, N. Y. C. R. R.
 Shaffer Freeman C. clerk, boards 60 Jones
SHAFER HENRY E. crockery, glass and chinaware, 39 State, h. 304 East Main.—
See back cover
 Shaffer Joseph, carpenter, 3 North av. bds. William
 Shaffer Wm. H. 39 State, bds. 304 E. Main
 Shaffer, see Schaffer, Schaeffer and Schafer
 Shaft Henry, teamster, 15 N. Water, house E. Main near Goodman [Caroline
 Shakeshaft Thomas, carpenter, house 21
 Shale Catharine, widow, house 51 Tremont
 Shale Fred. A. (*Shantz, Minges, Shale & Co.*), 15 N. Water, boards 11 Delevan
 Shale Joseph G. (*Odenbach & Shale*), 7 State boards 11 Delevan
 Shale Mary A. widow, house 11 Delevan
 Shales William, laborer, house 6 Saginaw
 Shand Margaret, widow, house 21 Sherman
 Shand William H. machinist, 100 South St. Paul, house 10½ Sherman
 Shankel Andrew, laborer, h. 13 Whitmore pk.
 Shankland Robert, at City Hospital
 Shanklin Jane R. widow, house 34 S. Ford
 Shankop Abram, peddler, house 20 Vose
 Shanly James H. produce, h. 55 Fulton av.
 Shanly John, laborer, house 14 Manhattan
 Shannon Alexander S. insurance agent, 122 Powers' bldgs. house 19 Elizabeth
 Shannon Dennis, harnessmaker, 98 E. Main, boards 97½ do.
 Shannon Jane, domestic, boards 129 Adams
 Shannon Jeremiah, laborer, house 6 Tyler
 Shannon Jeremiah, laborer, 181 East Main, house 20 Tyler
 Shannon John, laborer, h. Murray cor. Lyell

A. R. PRITCHARD & LIKLY,

GLOVES, CANES, ETC., A LARGE STOCK, No. 78 STATE STREET.

- Shannon Lizzie, forewoman, boards 142½ W. Main
- SHANNON MICHAEL**, merchant tailor, 12 East Main, house 7 Vine.—*See p. 543*
- Shannon Nellie, chambermaid, Osburn House
- Shannon Robert, cartman, house 129 Adams
- Shannon Robert F. removed from city
- Shannon William R. engineer, bds. 8 Kirk
- Shardlow William M. boards 5 Howell
- Sharkey James, deceased Sept. 1875
- Sharkey Libbie, tailoress, bds. 14 Prospect
- Sharp Albert, collector, house 60 Tappan
- Sharp Elizabeth, widow, house Rapids road
- Sharp Emmett W. removed to Webster
- Sharp Frederick, optician, bds. 23 Lowell
- Sharp George W. teamster, b. Henrietta av. near Pinnacle avenue
- Sharp Lewis, saloon, 94 St. Joseph, house do.
- Sharp Matilda Mrs. boarding house, 3 Achilles [n. Pinnacle av.]
- Sharp William, teamster, h. Henrietta av.
- Sharrod Edward, carpenter, h. 122 Champlain
- Shatz Joseph (*Shatz, Lowenthal & Leiter*), 42 State, house 55 North avenue
- SHATZ, LOWENTHAL & LEITER (J. Shatz, L. Lowenthal and H. Leiter)**, millinery, 42 State.—*See page 545*
- Shaughnessey John, laborer, house 6 Garden
- Shaughnessey Margaret, seamstress, boards 34 Oak
- Shaver Frank L. removed from city
- Shaver John, laborer, house 30 Gregory
- Shavlin Charles, shoemaker, h. 131 Adams
- Shaw Augustus, removed from city
- Shaw Charles D. cutter, 87 North Water, b. 110 University avenue [84 Kent]
- Shaw Eugene N. engineer, N. Y. C. R. R. b.
- Shaw Frank W. clerk, 2 Masonic block, bds. 35 Sophia [10 Cliff]
- Shaw James, salesman, 53 East Main, house
- Shaw James, house 37 Davis
- Shaw James B. pastor Brick Church, 198 Powers' bldgs. house 17 Clinton place
- Shaw James S. machinist, Court cor. Stone, house 208 Brown
- Shaw Jean, widow, house 23 Cypress
- Shaw Jean, teacher, Wadsworth School No. 12, boards 23 Cypress
- Shaw John, painter, 3 Canal, boards 146½ West Main [84 Kent]
- Shaw John, engineer, N. Y. C. R. R. house
- Shaw John F. shoemaker, 111 State, bds. 36 South Ford [University av.]
- Shaw John, car driver, house Carleton near
- Shaw Joseph P. music store, 16 East Main, house 2 Gorham
- Shaw Libbie Miss, teacher, bds. 23 Cypress
- Shaw Sally, widow, boards 6 Jay
- Shaw Sarah Miss, house 9 Atkinson
- Shaw Wellington H. bookkeeper, 55 Front, house 7 Culver park [2 Gorham]
- Shaw William P. clerk, 16 East Main, bds.
- Shay Dennis, file cutter, 107 Mill, house 68 Strong [h. Frances near Seward]
- Shay Levi J. file cutter, River n. N. Water,
- Shay Mary, seamstress, boards 5 Cliff
- Shay Mary, widow, house 40 Brown's block
- Shay William H. cooper, boards 5 Cliff
- Shea Joseph, steam fitter, 11 Exchange
- Shea Margaret, widow, boards 20 Glasgow
- Shea Patrick, engineer, Erie Railway, house 20 Glasgow [Joseph]
- Sheahan Dennis, street car driver, h. 79 St.
- Sheahan John, porter, 14 Exchange, house 105 Oak
- Sheahan John, laborer, house 5 Julia
- Shean Catharine, widow, b. East park near East avenue
- Shean Margaret, widow, house 15 Linden
- Shean Mary, dressmaker, boards 15 Linden
- Shean Patrick, coachman, East avenue cor. Alexander, house East park n. East av.
- Shean Wentzel, mason, house Wackerman near Jay [ton place]
- Sheard Mary A. dressmaker, bds. 10 Hamil-
- Sheard Thomas E. hairdresser, 5 Arcade, b. 76 Mt. Hope avenue
- Sheard Wm. laborer, house 10 Hamilton pl.
- Sheard William J. bds. 10 Hamilton place
- Shearns William, janitor, 64 State, house 46 Hunter [h. 126 Adams]
- Shears George A. clerk, 25 Exchange place,
- Shears Jacob D. removed from city
- Shears John E. removed to Wisconsin
- Shears Leonard B. deceased March, 1876
- Shears Lydia B. widow, house 19 Clifton
- Shears Maria, widow, house 3 King
- Shedd Eugene H. bookkeeper, 102 W. Main, house 29 Ambrose [h. 72 Kent]
- Shedd Kendrick P. grocer, 102 West Main,
- Sheedy John, laborer, Brown c. Jones, house 78 Oak [39 Grape]
- Sheedy Martin, engineer, N. Y. C. R. R. bds.
- Sheehan Daniel, hackman, bds. 116 Adams
- Sheehan John, laborer, house N. Union near railroad [b. 116 Adams]
- Sheehan Michael, stonecutter, 54 Fitzhugh,
- Sheehan Patrick, deceased
- Sheehan Patrick, laborer, house 25 Sherman
- Sheehan Wm. F. student, 15 Sophia, b. do.
- Sheehy John, flagman, Centre, h. 12 Magne
- Sheehy Patrick, removed to Avon
- Sheeler John, removed from city
- Sheeler Martin, carriagemaker, 3 Canal
- Sheffer Allen R. bookkeeper, 42 State, bds. 169 East Main [b. 68 S. St. Paul]
- Sheffer John A. lock finisher, Court c. Stone,
- Sheffer Thomas W. F. removed to Buffalo
- Sheffield Albert, teamster, boards 9 Brisbane
- Sheehan John, laborer, Whitney Mills, house 56 Smith corner Orchard [Atwater]
- Sheil Charles V. clerk, 14 W. Main, bds. 49
- Sheil Christopher (*Moran & Sheil*), 11 Front, house 49 Atwater [Atwater]
- Sheil Francis J. cutter, 72 Mill, boards 49
- Shelbeck Caspar, laborer, house 25 McDon-
- ald avenue
- Sheldon Burt L. prop. National Hotel, West Main cor. Fitzhugh, house do. [b. do.]
- Sheldon David D. bookkeeper, Congress Hall,
- Sheldon Edna M. music teacher, 7 Sibley's block, boards do. [Sibley's blk.]
- Sheldon Harriet O. Mrs. dressmaker, h. 7
- Sheldon Loomis, farmer, house 47 Jones av.
- Sheldon Nathaniel B. salesman, 26 West Main, h. 35 Adams

Sheldon Ogilvie L. insurance agent, 27 Arcade, b. 16 Elm
 Sheldon Paraclete, teacher, h. 7 Sibley's blk.
 Sheldon Peter, grocer, 241 N. Clinton, h. do.
 Sheldon Philo B. agent, 18 East Main, house 7 East avenue
 Sheldon Thomas J. clerk, boards 81 East av.
 Sheldon Tura, widow, house 81 East avenue
 Sheldon William J. foreman, 207 S. St. Paul near Griffith, bds. Chapman House
 Sheley Sylvanus, furnaceman, b. 57 Bolivar
 Sheley Sylvanus V. painter, boards 306 State
 Shell Jacob, leather finisher, 31 N. Water, boards 125 North Clinton
 Shell Joseph, laborer, boards 124 North av.
 Shell, see Schell
 Shelley Charles W. clerk, U. S. Express Co. 35 Exchange, house 148 Fitzhugh
 Shelley George W. express messenger, 35 Exchange, house 7 Edinburgh
 Shelley William B. agent, U. S. Express Co. 35 Exchange, house 99 do. [ton av.
 Shellington James, paper maker, h. 136 Ful-Shellington Jane, widow, h. Leavenworth alley near Brisbane
 Shellington William, paper maker, paper mill, bds. Leavenworth al. near Brisbane
 Shelly Elizabeth, dressmaker, 7 Hubbell pk. house do.
 Shelp Jacob W. boards 4 Centre park
 Shelp William, machine operator, house 21 Phelps avenue
 Shelter Henry, gilder, 57 State, h. 135 Hunter
 Shelter Jacob, laborer, h. 105 Caledonia av.
 Shelton Mary A. fancy goods, 11 Conkey av. house do. [No. 18, bds. 11 Conkey av.
 Shelton Sarah, principal, Concord School,
 Shepard Charles, laborer, bds. r. Stone near Allen's alley [boards do.
 Shepard Charles H. clerk, 12 S. St. Paul,
 Shepard Frank D. saloon, 12 S. St. Paul, boards do. [boards 11 Caroline
 Shepard Frank E. entry clerk, 73 E. Main,
 Shepard Frank P. salesman, h. 11 Caroline
 Shepard Joseph R. agent, 100 State, house 24 Caledonia avenue [Allen's alley
 Shepard Mary H. Mrs. house r. Stone near
 Shepard William H. house 12 S. St. Paul
 Shepard William H. (*Danforth & Shepard*), 43 Powers' buildings, house 94 Fitzhugh
 Shepard Wm. W. last manuf. 81 N. Water, house 33 Chestnut
 Shepardson Eugene A. paying cashier, Roch. Savings Bank, W. Main cor. Fitzhugh, boards 31 North Clinton
 Shepardson Lucy B. Mrs. h. 31 N. Clinton
 Shepcott Frank, fireman, N. Y. C. R. R. b. 13 Jones
 Shepherd Emma, widow, bds. 19 South av.
 Shepherd Jesse, lawyer, 56 Powers' bldgs. b. 59 Nassau [35 Lyell
 Shepherd John, miller, 35 N. Water, boards
 Shepherd William, deceased May 14, 1876
 Shepherd William A. carrier, Post Office, b. 59 Nassau [Nassau
 Sherar William W. cutter, 74 Mill, house 64
 Sherburne Henry W. salesman, 93 State, h. 28 Court

Sherburne Jethro R. engine dispatcher, Brown c. Jones, h. 351 Brown
 Sherer Michael, removed to Buffalo
 Sheridan Ann C. Miss, house 109 N. St. Paul
 Sheridan Benjamin, clerk, b. 70 Mt. Hope av.
 Sheridan Brensley, removed from City
 Sheridan Bridget, widow, boards 36 Seward
 Sheridan Edward C. removed to Bradford, Canada
 Sheridan John, house 55 Lake avenue
 Sheridan Patrick, shoemaker, 87 N. Water, house St. Joseph corner Catharine
 Sheridan Peter, upholsterer, 74 State, house 17 Elizabeth
 Sheridan Peter E. grocer, 186 W. Main, h. do.
 Sheridan Philip, laborer, boards 9 Edinburgh
 Sheridan Thomas, laborer, house 40 Frost av.
 Sheridan Wm. J. lawyer, 7 Baker's blk. bds. 55 Lake avenue [house 17 Hudson
 Sherlock James H. gas fitter, 25 Exchange,
 Sherlock Robert E. (*Sherlock & Sloan*), house 23 South Clinton
SHERLOCK & SLOAN (*R. E. Sherlock and S. Sloan*), gas and steam fitters and plumbers, 25 Exchange.—*See page 623*
 Sherman Adelle, boards 9 East avenue
 Sherman Albert, watchman, house 6 Hebard
 Sherman Albert C. removed to Syracuse
 Sherman Eugene L. boards 21 Vick park
 Sherman E. B. boards Osburn House
 Sherman Fanny, widow, boards 139 Adams
 Sherman Fletcher J. student, University of Rochester, boards 37 Howell
 Sherman George, shoemaker, b. 171½ E. Main
 Sherman George, house 138 West Main
 Sherman Henry, teamster, bds. 28 Litchfield
 Sherman Henry W. printer, 87 State, house 106½ West Main [Main, house do.
 Sherman Humphrey B. physician, 135 East
 Sherman James, foreman, Elizabeth corner Hill, house 130 Mt. Hope av. [Rowe
 Sherman Joseph B. machinist, h. Third near
 Sherman Levi, photographer, 18 W. Main, house 21 Vick park
 Sherman Martin, conductor, house 2 Hebard
 Sherman Mary F. Mrs. stitcher, b.66 Chatham
 Sherman Nettie, widow, house 218 W. Main
 Sherman Seth L. produce, 171 E. Main, house 12 Asylum
 Sherman Sherron, laborer, boards 2 Hebard
 Sherman Theron & Son (*Wm. H. Sherman*), produce, 203 E. Main, h. 48 N. Union
 Sherman Thomas M. civil engineer, house 154 West avenue
 Sherman William H. (*T. Sherman & Son*), 203 East Main, bds. 48 North Union
 Sherman Winfield S. assistant cashier, City Bank, 34 State, house 107 West Main
 Sherry Bernard (*J. C. Heughes & Co.*), 129 Mill, house at San Francisco
 Sherry Catharine, widow, h. 111 St. Joseph
 Sherry Ellen Miss, vest maker, house 111 St. Joseph
SHERRY GEORGE E. artesian wells, 17 St. Joseph, house do.—*See page 643*
 Sherry John, agent, house 49 Asylum
 Sherwin Julius H. watch maker, 6 Masonic block

- Sherwood Archie B. groom, 171 State, house 9 Otsego [house do.]
 Sherwood Edgar H. music teacher, 82 State,
 Sherwood Ellen, boarding house, 22 Frank
 Sherwood Frederick A. bookkeeper, 79 N. Water, boards 34 Troup
 Sherwood Helen M. shirtmaker, 94 State, h. do.
 Sherwood James L. cigarmaker, b. 27 North avenue [158 Exchange
 Sherwood Orville, brakeman, Erie railway, b. Sherwood Warren S. conductor, Erie Ry. house 158 Exchange [22 Frank
 Sherwood Wm. J. clerk, 11 E. Main, boards
 Shevlin Charles, shoemaker, 91 N. Water, house 131 Adams
 Shevlin Kate, dressmaker, bds. 14 Sherman
 Shevlin Mary, widow, house 14 Sherman
 Shewman George H. laborer, Erie freight house, boards Mansion near Violetta
 Shewman Matthew W. carpenter, h. Mansion opposite Violetta [Mansion
 Shewman William, carpenter, b. Violetta c.
 Shible Jacob, laborer, h. W. Maple n. Ames
 Shied Charles, laborer, house 61 Sanford
 Shied Charles, carriage maker, 10 S. Water, house 18 Childs
 Shiek Emeline, widow, bds. 12 Pinnacle av.
 Shields Henry, switchman, N. Y. C. R. R. house 14 Wait [near Lorimer
 Shields Henry, cutter, 14 Exchange, b. Frank
 Shields James, watchman, house r. 74 Oak
 Shields Marion C. hairworker, bds. Frank n. Lorimer
 Shields Robert, cutter, 5 Front, h. 25 Scio
 Shields Sarah, widow, boards 17 Lyell
 Shields Walter, miller, Irving Mills, h. Frank near Lorimer [Clinton c. Atwater
 Shields William H. clerk, 63 Front, house N.
 Shiers Selina, housekeeper, b. 157 Alexander
 Shilliady Joseph, flagman, N. Ford st. crossing, house 63 Allen
 Shilling Gustave, cigarmaker, h. 42 Ontario
 Shimer Augusta, widow, house 9 Franklin
 Shimer William I. clerk, 161 E. Main, boards 9 Franklin [house do.
 Shing Thomas (*Wah Lee & Co.*), 176 State,
 Shingulet John A. tailor, house 54 Cady
 Shipherd Minerva, widow, bds. 9 Romeyn
 Shipman Albert H. (*Shipman & Binder*), 111 North Water, boards 134 S. St. Paul
 Shipman Daniel M. physician, 29 Fitzhugh, house do.
 Shipman Henry Y. clerk, bds. 29 Fitzhugh
 Shipman Parson G. Mrs. house 2 Centre park
 Shipman & Binder (*A. H. Shipman and J. Binder*), bracket saw manufs. 111 North Water
 Shire Mary, widow, house 77 Smith
 Shirley John G. salesman, 69 State, house 99 Pinnacle avenue [Comfort
 Shirley John R. cutter, 24 State, house 11
 Shoetzer Babette, spectacles, h. 10 Atwater
 Shmidt Johanna, wax flower maker, boards 28 Franklin
 Shoat Charles, teamster, bds. 36 N. Frances
 Shoat Joseph, house 36 North Frances
 Shoder Mary Miss, button maker, boards 170 Champlain
 Shoder Martin, mason, house 170 Champlain
 Shoe John, printer, boards 247 State
 Shoe Peter, porter, 77 Mill, house 247 State
 Shoecraft Peter Mrs. widow, b. 120 East av.
 Shockency Ellen Miss, cork cutter, boards 53 Prospect
 Shockency Jennie, domestic, 72 Lake av.
 Shoemaker Frank, butcher, h. Rapids road near Genesee
 Shoemaker Frederick, laborer, house 3 Bay
 Shoemaker Peter, butcher, boards Magnolia near Plymouth avenue
 Shoemaker William, butcher, house Magnolia near Plymouth avenue [house do.
 Shoemann John, basket maker, 35 Weld
 Sholes Fifield, laborer, house 6 Huron
 Sholtus Chauncey H. bookkeeper, 51 North Water, house 122 North avenue
 Sholtus Lewis, carpenter, h. 7 Concord av.
 Sholtus Rufus K. grocer, 92 East avenue, b. 122 North avenue
 Sholtz George, porter, Brackett House
 Shone Alfred, carpenter, Exchange, c. Court, house 7 Whitmore park
 Shoot George, laborer, house Pinnacle av. n. cemetery [near cemetery
 Shoot William, laborer, boards Pinnacle av.
 Shorer August, turner, h. 189 North c. Wilson
 Shorer Basil, grocer, 5 Hudson, house do.
 Shorer Sebastian (*Shorer & Taillie*), house 76 William
SHORER & TAILLIE (*S. Shorer and H. J. Taillie*), iron column manufacturers, 145 N. Water.—*See page 682*
 Short Eliza, fitter, boards 54 Saxton
 Short John, laborer, boards 54 Saxton
 Short Martha, dressmaker, boards 54 Saxton
 Short Peter, coachman, 31 S. Clinton, house 21 Savannah [b. 80 Mt. Hope av.
 Short Rosa R. teacher, Munger school, No. 13,
 Shove Annie, widow, boards 15 John
 Shove Henry D. fireman, N. Y. C. R. R. h. 7 Woodbury
 Shove James M. painter, house 13 Kirk
 Shove Joseph A. deceased March 11, 1876
 Shove Mary, widow, boards 15 John
 Shove Perry, painter, boards 73 Hunter
 Showers A. Frank Miss, hair worker, 413 Brown, boards do.
 Showers Wm. H. carpenter, 413 Brown, h. do.
 Shraever Charles, laborer, house Monroe av. near Nichols' park [120 East av.
 Stuart Wm. D. surrogate, Court House, h.
 Stuart Wm. H. student, 24 Powers' bldgs. boards 15 South Union
 Shulman Levi, peddler, house 44 Catharine
 Shults Andrew, shoemaker, 92 State, house 8 Evergreen
 Shults Catharine, widow, house 93 Adams
 Shults Lewis R. clerk, 165 West Main, boards 170 1/2 W. Main [road n. Bay
 Shum Bernard, nurseryman, boards Webster
 Shum Joseph M. nurseryman, house Webster road near Bay [road near Bay
 Shum ebastian, nurseryman, boards Webster
 Shuman George, baker, Grape cor. Campbell, house 49 Orange [Clinton
 Shumbrunice George, laborer, boards 94 N.

Shutts Adam, baggageman, N. Y. C. depot, house 2 Oak
 Shyte Philip, teamster, h. Fifth av. n. Bay
 Siau Alexander, harnessmaker, 65 State, h. 50 Court
 Sibel Theodore, baker, h. 2 Ringlestein alley
 Sibert Henry, tailor, bds. Ames n. Campbell
 Sibley Hall, Prince corner College avenue
 Sibley Hiram, 49 Powers' bldgs. house East avenue corner Alexander
SIBLEY, LINDSAY & CURR (*R. A. Sibley, A. M. Lindsay, J. Curr, R. Liddle, and T. S. Johnston*), dry goods, ladies goods, etc. 73 East Main.—*See page 549*
 Sibley Rufus A. (*Sibley, Lindsay & Curr*), h. 5 Park avenue
 Sichel Abraham, grocer, 71 N. Clinton, h. do.
 Sickels Charles W. salesman, 53 E. Main, h. 65 Delevan
 Sickels Freeman E. deceased, January, 1876
 Sickels Jane, widow, house 7 Cobb
 Sickles Jane D. widow, house 66 South av.
 Sicker Ermina, widow, house 21 Savannah
 Sickler Hernando O. removed to Mill City, Pennsylvania
 Sickler M. M. removed from city
 Sickmond Mary, widow, house 40 Andrews
SIDDONS CHARLES S. plumber, gas and steam fitter, 96 East Main, house 95 Monroe avenue.—*See inside front cover*
SIDDONS JOHN, iron roofing and galvanized iron cornices, 90 E. Main, house 19 Prince.—*See front colored page*
 Siddons William H. machinist, 126 Mill, b. 22 Smith
 Sidey John R. printer, house 48 Hudson
 Siebe Geo. F. cigar manuf. 18 Atwater, h. do.
 Siebenpfeiffer Charles, pastor German Evang. Salem's church, h. Cataract n. N. St. Paul [near N. St. Paul
 Siebenpfeiffer Elizabeth, widow, b. Cataract
 Siebert August, shoemaker, 77 N. Water, h. 48 Sellinger
SIEBERT CASPAR, carpenter and builder, 105 Pinnacle av. h. do.—*See page 641*
 Siebert Caspar jr. carpenter, 105 Pinnacle av. boards do. [13 Weeger
 Siebert Caspar G. shoemaker, 111 State, h. Siebert Charles (*Kraft & Siebert*), 5 Ringelstein alley, boards 53 St. Joseph
 Siebert Ellen, widow, house 44 N. Water
 Siebert Ferdinand, machinist, 226 N. Clinton, boards do.
 Siebert Florian F. carpenter, house 5 Bond
 Siebert Frances, widow, h. 156 St. Joseph
 Siebert Frank, blacksmith, 226 N. Clinton, house do.
 Siebert Fred. laborer, h. Mark n. Hudson
 Siebert Geo. saloon, 14 Exchange pl. h. do.
 Siebert Henry, carpenter, house 51 Gregory
 Siebert Henry, tinsmith, 276 Brown, h. Jay near Childs
 Siebert Jacob, varnisher, 7 N. Water, bds. 51 Gregory [St. Joseph
 Sieber John, finisher, 38 Gorham, boards 156
 Siebert John, yardman, 51 Hudson, house 31 Mark
 Siebert John, laborer, house 10 Bay

Siebert John M. cabinetmaker, b. 10 Bay
 Siebert Leo, carpenter, h. 152 Plymouth av.
 Siebert Robert, spectacle maker, 179 N. St. Paul, boards 226 N. Clinton
 Siefert Michael, woodyard, 115 North av. h. 16 Delevan [West Maple
 Siegel Marcus, shoemaker, house Ames near Siegeler Herman, maltster, 139 N. St. Paul, house 10 McDonald avenue
 Sieger Maria, widow, h. 5 Campbell
 Sieger Mary, widow, house 73 Tremont
 Siegfried Henry C. laborer, 159 State, house 227 Brown
 Siegler Albert, tailor, 108 Chatham, boards 10 McDonald av.
 Sielaff August, laborer, house Livingston n. North St. Paul [avenue
 Siems Charles, switchman, b. Dake n. First
 Siems Joseph, laborer, h. Dake n. First av.
 Siener Geo. P. clerk, 115 E. Main, boards 14 Wilder
 Siener John A. cooper, house 14 Wilder
 Siener Matthew, moulder, 20 Court, boards 14 Wilder [cor. Frank
 Sienna Sister, teacher, Nazareth Convent, Jay
 Sigl Frances, tailoress, bds. 15 Shamrock
 Sigl John, frame maker, 38 Gorham, boards 15 Shamrock
 Sigl Joseph, shoemaker, house 15 Shamrock
 Sigler Herman, laborer, h. 10 McDonald av.
 Sihler David, baker, 262 State, boards do.
 Sihler John, saloon, 72 North av. house do.
 Sike Charles, music teacher, b. 2 Asylum
 Sike James B. salesman, 56 Hudson, boards 2 Asylum [2 Asylum
 Sike William, painter, 163 East Main, house
 Sikingaer Magdalene, stitcher, b. 43 Martin
 Silence Edward, carpenter, b. 146 S. St. Paul
 Silence Frederick, boatbuilder, Meigs street bridge, bds. 146 S. St. Paul
 Silence Martha, boards 146 S. St. Paul
 Silence Mary, house 146 S. St. Paul
 Silence Mary A. Mrs. boards 23 Broadway
 Siler Wm. waiter, W. Main cor. Front, b. do.
 Silko Charles, finisher, house 82 Chatham
 Silko Louisa, widow, house 82 Chatham
 Sill Beatrice M. widow, house 122 Fitzhugh
 Sill Ebenezer E. deceased August 20, 1875
 Sill George W. judge Municipal Court, 96 Powers' bldgs. b. 27 East avenue
SILL STOVE CO. stoves and hollowware manufs. 187 W. Main.—*See page 615*
 Siller Frederick, laborer, h. 120 Whitney
 Siller Frederick jr. laborer, bds. 120 Whitney
 Silliman Mary E. boards Monroe av. corner Nichols park
 Silver Elizabeth, widow, house 31 Charlotte
 Silver Robert H. teamster, bds. 31 Charlotte
 Simmelink Henry J. carpenter, b. Hudson near Berlin
 Simmelink John B. (*Simmelink & Van Ness*), bds. Hudson near Berlin
 Simmelink John H. carpenter, Hudson near Berlin, house do.
 Simmelink & Van Ness (*J. B. Simmelink and J. Van Ness*), flour and feed, 71 1/2 Hudson
 Simmons Ann, widow, h. 11 University av.

Simmons Charles, packer, 113 W. Main, h. 30 Plymouth avenue
 Simmons Charles N. sup't public schools, Free Academy bldg. h. 8 Madison park
 Simmons Edward, house 26 Tappan
 Simmons George, boards 11 University av.
 Simmons Herbert G. student, 33 Smith's block, b. 8 Madison park [ington
 Simmons Honora, widow, h. 41 S. Wash-
 Simmons H. L. clerk, bds. Chapman House
 Simmons James, cabinetmaker, 186 State, h. 115 Clifford
 Simmons James, clerk, 95 East av. boards 10 North Union [University avenue
 Simmons James, painter, 165 E. Main, h. 153
 Simmons John, carpenter, 70 Bartlett, h. do.
 Simmons Lizzie, widow, h. 145 Plymouth av.
 Simmons Martin B. grocer, 95 East av. h. 10 North Union
 Simmons Nancy Mrs. widow, h. 7 East av.
 Simmons Solomon, shoemaker, 87 N. Water, boards 117½ East Main
 Simon Ephraim, removed to Phelps
 Simon Frank, clerk, 47 Mill, h. 5 Union al.
 Simon Jacob, peddler, house 14 Vienna
 Simon Nicholas, clerk, 36 S. St. Paul, b. 5 Union alley [R. house 62 Oak
 Simonds Phordice B. engineer, N. Y. C. R.
 Simons Charles S. salesman, 17 State, bds. 142½ West Main
 Simons Isaac, peddler, 14½ East Main
 Simons John C. (Marson & Simons), 119 Powers' bldgs. house 128 Plymouth av.
 Simons Louis N. painter, bds. 62 West av.
 Simons Max, peddler, house 5 Herman
 Simons Sarah, widow, house 62 West avenue
 Simons, see Symonds [mer n. Genesee
 Simpson Benjamin F. stone quarry, h. Sum-
 Simpson Benjamin F. student, University of Rochester, boards 5 Stillson
 Simpson Charles, h. Briggs place n. College
 Simpson Charles M. machinist, bds. 5 North Frances
 Simpson Edward, laborer, b. 319 N. St. Paul
 Simpson Edwin, carpenter, 100 S. St. Paul, boards 98 do. [near Ridge road
 Simpson Eliza, widow, house Lake avenue
 Simpson Geo. teamster, h. 67 University av.
 Simpson Henry, cartman, house 1 Hope
 Simpson James, laborer, house 111 Champlain
 Simpson James M. teamster, 100 South St. Paul, house 98 do. [near College
 Simpson Jane Miss, dressmaker, b. Briggs pl.
 Simpson Jane Miss, boards 40 Franklin
 Simpson John, constable, h. 6 N. Stillson
 Simpson John, ice dealer, boards Rowe near Erie canal [h. 20 Marion
 Simpson John H. paint grinder, 7 W. Main,
 Simpson John T. farmer, h. Lake av c. Lake View park
 Simpson Joseph M. clerk, house 4 Vine
 Simpson Joseph T. stonecutter, h. 98 Strong
 Simpson Lizzie A. domestic, 78 Lake avenue
 Simpson Mary, dressmaker, b. 19 Ward
 Simpson Mary A. widow, house 40 Franklin
 Simpson Mary J. widow, house 5 N. Frances
 Simpson Rebecca F. Miss, stitcher, boards 5 North Frances

Simpson Robert J. teamster, b. 55 Goodman
 Simpson Samuel A. carpenter, h. Briggs' pl.
 Simpson Thomas, teamster, b. 319 N. St. Paul
 Simpson Thomas, ice dealer, Lake av. near Ridge road, house do.
 Simpson William, house 319 North St. Paul
 Simpson William J. painter, house 26 Hunter
 Simpson William S. teamster, h. 64 University avenue [Genesee
 Simpson William T. malt, h. Hunter near
 Simpson William W. student, University of Rochester, boards 15 James
 Sinclair Angus, tailor, house 67 N. Water
 Sinclair Francis H. pastor St. Peter and St. Paul's church, house E. Maple c. King
 Sinclair Mary, widow, boards 84 Reynolds
 Sinden Charles, painter, house 14 Munger
 Singer John, nurseymen, 38 Scantom
 Singer Sewing Machines, 43 State
 Singer Wm. peddler, h. 17 University avenue
 Sinkel Joseph, laborer, house 5 Saratoga av.
 Sinnett Catharine, widow, house 51 Lyell
 Sinnot Eliza, laundress, b. 5 Brown's alley
 Sintiff Joseph, spring bed maker, 51 St. Joseph [house 57 Meigs
 Sintzenich Augustus, printer, 3 West Main,
 Sintzenich Charles A. teamster, b. 42 Griffith
SINTZENICH EDWIN B. propr. Rochester Steam Fire Engine Works, 12 South Water, house 292 E. Main.—See page 674
 Sintzenich Esther, widow, house 66 Andrews
 Sintzenich Julia M. private school, 66 Andrews, boards do.
 Sinwald Louis, shoemaker, house 25 Henry
 Sippel Killian, carpenter, house 39 Sellinger
 Sippel Leopold, wagonmaker, b. Straub al. near Rowe
 Sircu Frank B. collarmaker, 98 East Main, b. Henrietta avenue near Pinnacle avenue
 Sircu Jacob, carpenter, h. Henrietta av. n. Pinnacle av. [Pinnacle av.
 Sircu John, laborer, house Henrietta av. n.
 Sirrinc Charles M. clerk, b. 142½ W. Main
 Sisselin George, baker, 154 W. Main, b. do.
 Sisters of Charity, at St. Mary's Hospital
 Sisters of Mercy, 5 South
 Sisters of Notre Dame, 32 King
 Sisters of St. Joseph, 40 Glasgow
 Sixt Frank X. carpet weaver, 11 Hope, h. do.
 Sizer Allie, telegrapher, b. Culver n. University avenue
 Sizer D'Oiph, broommaker, house 21 Pearl
 Skellie M. Bell, boards 141 Powers' bldgs.
 Skelly Frank, shoemaker, 87 N. Water, bds. 7 Martin
 Skelly John, laborer, 10 S. Water, h. 7 Martin
 Skelly Luke J. shoemaker, 77 N. Water, h. 47 Rauber [demy, b. 27 Howell
 Skelton Philip, student, Roch. Free Aca-
 Skidmore Howland, clerk, b. 16 East avenue
 Skidmore Smith, laborer, house Nichols n. Jennings [h. Cady n. Summer
 Skillicorn Thomas, teamster, 81 N. Water,
 Skillicorn William, teamster, 33 West av. b. Cady n. Summer
 Skillman Abram, upholsterer, 184 State, b. Clifford near St. Joseph [24 Glasgow
 Skillman Jacob, watches, &c. 35 W. Main, h.

Skillman Jacob T. removed to Chicago, Ill.
 Skillman John C. painter, 14 Stone, house 10
 Channing [c. Foechner, h. do.
 Skillman Peter E. boots and shoes, 104 Hudson
 Skinner Clarinda, widow, h. Bates n. Sibley
 Skinner Frank T. bookkeeper, Express Print-
 ing Co. 23 West Main, h. 49 South av.
 Skinner Frederick H. blacksmith, Exchange
 opp. Glasgow, boards 62 Hunter
 Skinner Harriet Mrs. embroidery, h. 164 State
 Skinner Thomas D. perfumery manuf. 205
 Plymouth av. house 78 Fitzhugh
 Skuse Ann, widow, boards 10 Ontario
 Skuse Charles, removed to Chili
 Skuse Daniel, laborer, house 16 Ontario
 Skuse Francis, cooper, Finney c. Davis, bds.
 25 Ontario [house 25 Ontario
 Skuse Francis N. cooper, Finney c. Davis,
 Skuse James, foundryman, 150 N. Water, b.
 16 Ontario [119 Scio
 Skuse James, cooper, Finney c. Davis, house
 Skuse James, removed to Chili
 Skuse John, cooper, Finney c. Davis, boards
 25 Ontario [25 Ontario
 Skuse Richard, cooper, Finney c. Davis, b.
 Skuse Richard, removed to Chili
 Skuse Wm. cooper, Finney c. Davis, boards
 25 Ontario [Clarkson
 Skutt David, peddler, 144 E. Main, house at
 Slade Henry (*McGill & Slade*), 195 E. Main,
 boards 7 Hamilton place
 Slade Patience Miss, house 7 Hamilton place
 Slager Jacob, butcher, house North av. cor.
 Jennings [Tappan
 Slager Marine, news boy, N. Y. C. R. R. b. 42
 Slager Simon W. gilder, house 42 Tappan
 Slarks William, clerk, 26 South St. Paul, h.
 45 Alexander
 Slater Elizabeth, widow, house 89 Scio
 Slater John W. teamster, house 7 White
 Slattery Johanna Miss, boards 36 Lake av.
 Slattery John, laborer, house Plymouth av.
 near Cottage [Clifton
 Slattery John, engineer, h. Henion place n.
 Slattery John, watchman, 65 N. Water, bds.
 37 Platt
 Slattery Mary, widow, bds. 40 Brown's alley
 Slattery Patrick, laborer, house 41 Cady
 Slattery Roger, tinsmith, 266 State, boards 40
 Brown's alley [Erie
 Slattery Thomas, clerk, Platt cor. Kent, h. 2
 Slattery Timothy, stove moulder, 187 West
 Main, boards 41 Cady
 Slattery Timothy, watchman, b. 40 Brown's
 alley [40 Brown's al.
 Slattery Wm. laborer, 65 North Water, bds.
 Slauson Edward M. boards 11 Linden
 Slauson Theodore, agent, house 11 Linden
 Slaven Dennis, bartender, 135 West Main,
 boards do.
 Slaven Elizabeth, widow, h. Moore n. R. R.
 Slaven Elizabeth A. dressmaker, bds. Moore
 near R. R.
 Slaven Matthew, proprietor Wimble House,
 85 Mill, h. do.
 Slaven Patrick, laborer, b. Moore near R. R.
 Slaven William H. student, b. Wimble House
 Slavin Patrick, laborer, 83 State

Slayton Mary A. Miss, teacher, boards Ever-
 green near Evergreen park
 Slayton Vira, stitcher, boards 4 Erie
 Sleight May L. boards 75 North Union
 Sliker Jenny V. clerk, 156 East Main, boards
 5 East avenue
 Sloan Anna E. dressmaker, boards 5 Oak
 Sloan Robert, policeman, City Hall, house 82
 Tappan
 Sloan Rosa, tailoress, boards 171½ East Main
 Sloan Samuel (*Sherlock & Sloan*), 25 Ex-
 change, house 37 South Clinton
 Sloane John A. laborer, 255 North St. Paul,
 house 27 Scrantom
 Slobbe Cornelius, blacksmith, h. 33 Rhine
 Slobbe William, peddler, house 23 Edward
 Slocumb Siva, widow, boards 26 North av.
 Slocum Albert G. bookkeeper, 13 Powers'
 bldgs. boards 3 Livingston park
 Slocum A. Gaylord, removed to Wellsville
 Slocum George F. student, University of Ro-
 chester, boards 35 Chestnut [field
 Slocumb William, laborer, house 33 Litch-
 Slocumb William H. overseer, Monroe Co.
 Penitentiary, boards do.
 Sloman Isaac M. & Son (*M. I. Sloman*), cloth-
 ing, 36 Mill, house 64 Court
 Sloman Marcus I. (*I. M. Sloman & Son*), 36
 Mill, boards 64 Court
 Sloman Mark, house 6 Rome
 Sloman Selim, salesman, 73 Mill, b. 6 Rome
 Sloney John, teamster, b. 16 Vincent place
 Sly Charles M. removed to Medina
 Sly George W. carpenter, h. 23 Phelps av.
 Slyck Joseph, deceased Dec. 29, 1875
 Slyck Magdalena, widow, b. 84 Champlain
 Slyck Maria, widow, house 71 Reynolds
 Smalheer Leonard, laborer, house rear Hay-
 ward park near St. Joseph
 Small James, removed to Auburn
 Small, see Schmalz [av. n. Bay
 Smallfield Frederick, blacksmith, b. Fourth
 Smart Annie E. gilder, 38 Gorham, boards 1
 Sheridan park [park
 Smart Frank, casket coverer, b. 1 Sheridan
 Smart John, house 32 West avenue
 Smeed Henry A. compositor, 82 West Main,
 boards 45 Hamilton place
 Smeed James M. machinist, bds. 11 Comfort
 Smeed Mary, widow, b. East av. c. Lawrence
 Smeed William, moulder, h. 45 Hamilton pl.
 Smelt William, livery stable, 7 Ely, house
 24 Stone [Stone
 Smelt William H. clerk, 7 Ely, boards 24
 Smering Joseph J. cigarmaker, 117 State,
 boards 18 Trowbridge [28 Adams
 Smiley Archibald, cutter, 8 West Main, h.
 Smiley Samuel, laborer, house 44 Thompson
 Smith Aaron, laborer, house Scottsville road
 near rapids
 Smith Abby J. widow, house 77 North av.
 Smith Addy, widow, boards 1 Harrison
 Smith Adelbert, salesman, 53 State, h. Glen-
 wood avenue corner Third [Weld
 Smith Adolph, painter, 88 Arcade, bds. 58
 Smith Agnes, domestic, boards 8 Broadway
 Smith Alba, gardener, h. Plymouth avenue
 near rapids

- Smith Albert, peddler, 144 East Main, house
44 Caroline
- Smith Albert C. printer, 82 West Main, house
24 West avenue
- Smith Albert H. boards 49 Pearl
- Smith Alexander, house Smith cor. Walnut
- Smith Alexander J. carpenter, 93 Exchange,
house Second near Glenwood avenue
- Smith Alfred, engineer, h. 19 Concord av.
- Smith Alfred H. conductor, N. Y. C. R. R.
house 17 Jay [b. 17 Marshall
- Smith Alfred S. student, University of Roch.
- Smith Allen C. cartman, house North York
near R. R.
- Smith Alletta, widow, house 81 Troup
- Smith Almira Miss, dressmaker, bds. 26 N.
Frances
- Smith Alonzo H. painter, house 14 Gorham
- Smith Amanda, widow, house 63 West av.
- Smith Andrew, cartman, house 6 Alexander
- Smith Andrew, shoemaker, h. 44 Caroline
- SMITH ANDREW V. & CO.** (C. H. Gif-
ford), harness, trunks and gloves, 65
State, house 111 Lake av.—See page 605
- Smith Ann, widow, house 57 Monroe avenue
- Smith Anna A. widow, h. 213 Monroe av.
- Smith Anna E. domestic, boards 73 Meigs
- Smith Apollos, boards 153 Alexander
- Smith Arthur A. protecting agency, 33 Ex-
change, house do.
- Smith Asa, boards 120 Lake avenue
- Smith Asa, tinsmith, 57 State, boards 9 Jones
- Smith Asa U. real estate, house 10 Rowley
- Smith Austin S. boots and shoes, 8 E. Main,
house 87 South Union [Prospect
- Smith Azro T. bookkeeper, 4 Allen, bds. 8
- Smith A. Byron, bookkeeper, 36 Exchange,
boards 29 Plymouth avenue
- Smith Bardo F. teamster, h. 15 Cayuga pl.
- Smith Benjamin, brakeman, b. 27 North av.
- Smith Benjamin, pattern maker, Mill cor.
Factory, house 85 Weld
- Smith Benjamin, boards 166 Plymouth av.
- Smith Bernard, stonecutter, 54 Fitzhugh, h.
43 Sanford
- Smith Betsey, widow, bds. 22 North avenue
- Smith Bridget T. widow, h. 22 Brown's alley
- Smith B. Palmer, salesman, Court st. bridge,
house 57 Chestnut [Mathews
- Smith Caleb B. clerk, 79 E. Main, house 22
- Smith Carlos, printer, 82 West Main, house
14 Trowbridge
- Smith Caroline, dressmaker, h. 2 S. Clinton
- Smith Catharine, widow, h. 97 Pinnacle av.
- Smith Catharine, widow, house 11 Cobb
- Smith Catharine Mrs. tailorress, b. 36 Hickory
- Smith Catharine J. Miss, bds. 84 East av.
- Smith Catharine W. tailorress, b. 11 Franklin
- Smith Cecilia, spectacle maker, 179 N. St.
Paul, boards 1 Spencer
- Smith Celinda B. widow, house 53 Plymouth
avenue
- Smith Charity, widow, boards 6 Clarkson
- Smith Charles, nurseryman, boards 35 Kent
- Smith Charles jr. nurseryman, bds. 35 Kent
- Smith Charles, shoemaker, 14 N. Water, h.
41 Concord avenue
- Smith Charles, cabinetmaker, house 5 Vine
- Smith Charles, moulder, 8 Hill, h. Wilder
opposite Whitney
- Smith Charles E. car driver, h. 125½ State
- Smith Charles F. (Smith, Perkins & Co.), 16
Exchange, house 87 Fitzhugh
- Smith Charles H. engineer, h. 15 Concord av.
- Smith Charles H. fireman, Jay corner canal,
boards 60 Jay
- Smith Charles J. house 5 Vine
- SMITH CHARLES L.** boatbuilder, oppo-
site 53 Mt. Hope av. h. 21 Alexander.—
See page 576 [h. 26 Channing
- Smith Charles L. carpenter, 87 Exchange,
Smith Charles R. liquors, 32 Exchange, h. 5
Edinburgh [b. 9 Jones
- Smith Charles W. bartender, Brackett House,
Smith Christian, house 287 St. Joseph
- Smith Christian, shoemaker, 7 Spring, house
1 Hoeltzer
- Smith Clara, stitcher, boards 32 Stone
- Smith Clifton A. sawyer, Court st. bridge, b.
East avenue cor. Stillson [Joiner
- Smith Conrad, shoemaker, 92 State, house 81
- Smith Daniel W. pattern manufacturer, 187
West Main, house 45 Ford
- Smith Delia Miss, boards 40 North avenue
- Smith Dell W. clerk, house Glenwood av.
- Smith Edgar B. clerk, 20 State, b. 81 Fitz-
hugh [boards 22 Favor
- Smith Edward F. compositor, 12 East Main,
Smith Edward M., U. S. Consul (Mannheim,
Germany), 45 Smith's block
- Smith Edwin C. insurance agent, 45 Powers'
buildings, house 16 Union park
- Smith Edwin M. salesman, 80 State, boards
53 Atkinson
- Smith Elias, builder, house 21 Emerson
- Smith Elijah F. house 10 Canal
- Smith Eliza, widow, boards 8 Edmonds
- Smith Eliza A. widow, house 9 Jones
- Smith Elizabeth Miss, h. 145 Plymouth av.
- Smith Elizabeth, widow, boards 19 Penn
- Smith Elizabeth Mrs. fancy goods, 44 South
avenue, house do.
- Smith Ella, widow, boards 14 Swan
- Smith Ellen J. artist, 97 Powers' bldgs. bds.
13 Hamilton place
- Smith Elliott F. carpenter, h. 20 Reynolds
- Smith Emily P. Mrs. bds. 12 S. Washington
- Smith Emma, widow, boards 26 Stillson
- Smith Emma J. teacher, Children's Home,
263 North St. Paul, boards do.
- Smith Erastus, teamster, b. Genesee n. rapids
- Smith Ernest O. teamster, b. 91 N. Clinton
- Smith Ernst L. carpenter, house 44 Gorham
- Smith Etta Miss, boards 52 Tappan
- Smith E. Darwin, justice Supreme Court, h.
11 S. Washington [11 S. Washington
- Smith E. Darwin jr. bookkeeper, 15 Mill, b.
- Smith Fordyce R. machinist, h. Culver pl. n.
University avenue [108 Hollister
- Smith Frank, laborer, 141 North Water, bds.
- Smith Frank, seamstress, boards 5 Selden
- Smith Frank L. gen'l. sec. Young Men's
Christian association, 18 E. Main, b. 11
Chestnut
- Smith Frank P. reporter, Democrat and
Chronicle, 3 W. Main, bds. 347 State

Smith Frank R. bartender, 169 E. Main, h. 59 University avenue
 Smith Frank R. engraver, bds. 21 Emerson
 Smith Frank S. removed from city
 Smith Franklin B. (*Smith, Johnson & Co.*), h. 11 Evergreen
 Smith Frederic, street car driver, b. 25 Allen
 Smith Frederic J. boatman, bds. 8 Prospect
 Smith Fred. M. clerk, 85 E. Main, bds. 36 North Washington [23 Clinton pl.
 Smith Frink H. dry goods, 79 E. Main, bds.
 Smith George, porter, 25 Mill, h. 63 Martin
 Smith George, tinsmith, 244 State, b. Ayer's Hotel
 Smith George, mason, house 111 Frank
 Smith George, house 42 Concord avenue
 Smith George B. 17 Powers' bldgs. house 120 West avenue
 Smith George H. student, boards Oakland
 Smith George L. clerk, bds. 118 Lake avenue
 Smith George N: 33 E. Main, b. 6 Chestnut
 Smith Geo. R. student, boards 21 Emerson
 Smith George T. sexton, house 2 Thorn alley
 Smith George W. saloon, 23 Exchange pl. house 52 Troup
 Smith Giles C. carpenter, house 20 Reynolds
 Smith Giles H. carpenter, house 128 Adams
 Smith Hannah, dressmaking, 19 Palmer's block, house do.
 Smith Harvey, boards 20 Clarissa
 Smith Henry, brakeman, N. Y. C. R. R. b. 173 North
 Smith Henry, clerk, house 17 Lawrence
S MITH HENRY B. coal, West Main cor. Exchange, and 163 Exchange, boards 4 James.—*See page 600*
 Smith Henry C. ass't. engineer Roch. Water Works, house 39 Ambrose
 Smith Henry E. salesman, b. Congress Hall
 Smith Henry F. (*C. R. Tompkins & Co.*), Mill cor. Factory, house 81 Fitzhugh
 Smith Henry L. salesman, house 78 West av.
 Smith Henry L. boards 2 N. Washington
 Smith Henry W. boatbuilder, h. 28 Alexander
 Smith Hervey H. printer, 33 Exchange, h. 3 Summer [Furnace, h. 66 Martin
 Smith Hiram W. screw manufacturer, Mill c.
 Smith Hugh, laborer, house Hollenbeck
 Smith Hugh A. clerk, 17 W. Main, b. 9 Elm
 Smith Hulbert B. machinist, Brown c. Jones, house 25 Spencer
 Smith Ida, seamstress, b. 30 Pearl [green
 Smith Isaac O. supt. 115 Arcade, house Ever-
 Smith Israel, house 23 Clinton place
 Smith Jacob, carpenter, house 51 Joiner
 Smith Jacob, tollgate keeper, Lake av. h. do.
 Smith Jacob, machinist, lower falls, house 58 Saxton
 Smith Jacob, sawyer, house 126 S. St. Paul
 Smith Jairus, house 7 Swan
 Smith James, peddler, house 182 Scio
 Smith James, switchman, house 4 Pitt
 Smith James, collarmaker, 129 State, house 24 Bolivar
 Smith James C. switchman, h. 18 Hickory
 Smith James H. brakeman, bds. 21 Orange
 Smith James P. shoe manuf. River near N. Water, boards 146 Scio

Smith Jasper O. clerk, 3 W. Main, bds. 146½ West Main
 Smith Jennie M. dressmaker, 256 State, h. do.
 Smith Jeremiah D. machinist, house 107 Jay
 Smith John, saloon, 52 Allen, house do.
 Smith John, grocer, 43 Orange, house do.
 Smith John, nurseryman, boards 35 Kent
 Smith John, laborer, boards 21 Orange
 Smith John, wool, 13 N. Water, and (*Woodbury, Morse & Co.*), house 3 Chestnut
 Smith John, sawyer, house Cliff opp. White
 Smith John, laborer, house 5 Plum alley
 Smith John, blacksmith, 4 Smith, house do.
 Smith John A. hairdresser, 100 E. Main, bds. 41 Stone
 Smith John A. carpenter, house 16 East av.
S MITH JOHN A. door and sash maker, 13 Warehouse, h. at Gates.—*See page 651*
 Smith John C. (*Smith & Poppy*), h. 24 Frances
 Smith John D. machinist, 138 Mill, h. 287 St. Joseph [b. 130 Caledonia av.
 Smith John H. glassblower, 178 Plymouth av.
 Smith John N. house 12 Atkinson
 Smith John P. carpenter, h. Lewis n. N. Union
 Smith John P. printer, 43 Orange, bds. do.
 Smith John R. (*Smith & Chester*), Mill foot Brown, house 9 James [Jay
 Smith John T. grocer, 82 N. St. Paul, b. 18
 Smith John W. filecutter, River n. N. Water, house 24 Smith
 Smith John W. boatbuilder, house 49 Pearl
 Smith John W. stonecutter, 22 West avenue, house 37 Litchfield [3 Chestnut
 Smith John W. clerk, 13 N. Water, boards
 Smith John W. teamster, 92 Allen, h. 2 Magne
 Smith, Johnson & Co. (*F. B. Smith, F. A. Johnson and J. M. Smith*), saw gummers, 115 Arcade
 Smith Joseph, moulder, house 132½ Jay
 Smith Joseph (*A. Schwirk & Co.*), 15 Warehouse, h. 52 Strong n. Seward
 Smith Joseph, glazier, 13 Warehouse, house 22 Channing
 Smith Joseph A. agent, boards 88 Saxton
 Smith Joseph A. clerk, 7 West Main, house 112 Monroe avenue [Woodbury
 Smith Joseph A. tanner, 51 N. Water, h. 25
 Smith Joseph M. (*Smith, Johnson & Co.*), h. 1 Evergreen [h. 47 East av.
 Smith J. Moreau, iusurauce, 5 Powers' bldgs.
 Smith Karl H. machinist, b. 13 Hamilton pl.
 Smith Leo A. cutter, 36 Mill, house Frances corner Hunter
 Smith Leonard S. barkeeper, Brackett House, house 12 Jones
 Smith Lewis E. house Oakland cor. Mt. Vernon avenue [39 Ambrose
 Smith Lida Miss, clerk, 60 West Main, bds.
 Smith Lloyd K. salesman, 121 W. Main, h. 20 Emerson
 Smith Lucius H. painter, boards 9 Jones
 Smith Lydia F. teacher, Munger School, No. 13, boards 213 Monroe avenue
 Smith Lydia P. boards 3 Gibbs
 Smith Lora Mrs. dressmaker, h. 106½ W. Main
 Smith Lorenzo M. miller, h. 154 N. St. Paul
 Smith Lovisa C. Mrs. h. 16 N. Washington
 Smith Lucinda K. widow, bds. 39 Ambrose

- Smith Maggie A. Miss, corkcutter, 205 Plymouth av. b. Frost av. c. Seward
- Smith Margaret, nurse, house 26 Hudson
- Smith Margaret C. widow, b. 105 Fitzhugh
- Smith Martha Mrs. widow, house 41 Lyell
- Smith Martha A. Mrs. bds. 33 University av.
- Smith Martha H. widow, house Culver park near East avenue
- Smith Mary, domestic, 61 Lake av. [h. do.]
- Smith Mary, waiter, Whitcomb House
- Smith Mary, widow, house 21 Orange
- Smith Mary A. widow, house 7 Warehouse
- Smith Mary A. domestic, 13 Saratoga avenue
- Smith Mary A. dressmaker, 8 Briggs' block, house do.
- Smith Mary C. spectacle maker, b. 1 Spencer
- Smith Michael, clerk, 2 S. St. Paul, boards 88 Saxton
- Smith Michael, market, 141 W. Maple, h. do.
- Smith Michael, laborer, house 116 Bartlett
- Smith Michael A. conductor, bds. 21 Orange
- Smith Milton Husbands, salesman, b. Culver park near East av. [Howell]
- Smith Milton H. printer, 33 Exchange, b. 14½
- Smith Mortimer, house 288 North
- Smith Nancy C. widow, bds. Lewis n. Meigs
- Smith Nelson A. carpenter, h. 118 Lake av.
- Smith Nicholas H. blacksmith, 107 S. St. Paul, house 24 Grand [road]
- Smith Norton P. b. Lake av. n. Little Ridge
- Smith Orrin L. saw filer, house 206½ W. Main
- Smith Otis M. clerk, Evening Express, 23 W. Main, house 81 Tappan
- Smith Patrick, laborer, h. Cottage n. Seward
- SMITH, PERKINS & CO.** (*C. F. Smith, G. H. Perkins and H. W. Brown*), wholesale grocers, 14, 16 & 18 Exchange.—*See page 550*
- Smith Peter, laborer, bds. 17 McDonald av.
- Smith Peter, blacksmith, house 102 Adams
- Smith Peter J. shoemaker, 50 Front, boards 24 Edwards
- Smith Phineas A. house 4 Frank
- Smith Phylinda C. Miss, tailoress, 68 Smith's block, boards 17 James
- Smith Porter H. (*Wilson & Smith*), 196 Powers' bldgs. house 71 Hickory
- Smith Rebecca, stitcher, boards 13 Howell
- Smith Richard Mrs. dressmaker, house 42 Gorham
- Smith Richard, shoemaker, h. 42 Gorham
- Smith Robert, quarryman, house Norton n. North St. Paul [house do.]
- Smith Robert B. painter, 13 Hamilton place,
- Smith Ruby J. surveyor, 57 Arcade, boards 19 Elizabeth
- Smith R. J. physician, 45 Fitzhugh, house at Brockport
- Smith Samuel, foreman, 87 N. Water, bds. Andrews
- Smith Samuel, blacksmith, boards 4 Smith
- Smith Samuel I. clerk, 73 E. Main, boards 126 Fitzhugh
- Smith Samuel, driver, boards 23 Stone
- Smith Samuel W. laborer, h. University av. near Round House
- Smith Sarah, tailoress, boards 30 Hanover
- Smith Sarah M. b. East av. cor. Alexander
- Smith Sidney J. sleeping car conductor, N. Y. C. R. R. boards Brackett House
- Smith Sidney N. agent, h. 113 Caledonia av.
- Smith Silas O. Mrs. widow, h. Gibbs c. Grove
- Smith Sophia, widow, house 1 Allen's alley
- Smith Thaddeus F. cigarmaker, boards 45 South Ford
- Smith Theodore E. boards 35 Glasgow
- Smith Theodore G. removed to California
- Smith Theodore R. farmer, boards tollgate Lake avenue [ald avenue]
- Smith Thomas, picture agent, h. 17 McDon-
- Smith Thomas, nurseryman, Frost avenue c. Olean, house Frost avenue n. Frances
- Smith Thomas, laborer, Erie freight house, house 24 Frank [house 8 Emerson]
- Smith Thomas, bookkeeper, Mill c. Factory,
- Smith Thomas, sawyer, house 147 Brown
- Smith Thomas E. nurseryman, h. 36 Seward
- Smith Thomas J. Mrs. dressmaker, 14 Mortimer, boards do.
- Smith Thomas J. manager, A. & P. telegraph, 7 Arcade, house 14 Mortimer
- Smith Tillman Sister, St. Boniface School, boards 3 Grand
- Smith Townsend W. boatman, h. 8 Prospect
- Smith Valentine, laborer, house 34 Tyler
- Smith Vincent, carver, 184 State, boards 41. West Maple [bds. 11 S. Washington]
- Smith Vincent M. lawyer, 140 Powers' bldgs.
- Smith Willard J. brakeman, N. Y. C. R. R. house 59 Hudson [near city line]
- Smith William, blacksmith, h. North Clinton
- Smith William, boards 56 Tremont
- Smith William, laborer, h. Saxton n. Lyell
- Smith Wm. blacksmith, 3 Canal, h. 10 Dean
- Smith William, laborer, Livingston near N. St. Paul
- Smith William, music teacher, bds. 10 Scio
- Smith Wm. carpenter, h. 18 Gardiner park
- Smith William, laborer, house 13 Ely
- Smith William, machinist, 124 Mill, boards Frank corner Jay
- Smith William, moulder, h. 21 N. St. Paul
- Smith Wm. A. carpenter, b. 18 Gardiner pk.
- Smith William Bacon, removed to Kansas
- Smith William B. shoemaker, boards 14 Trowbridge
- Smith Wm. B. carpenter, house 18 Allen
- Smith William B. carpenter, h. 36 Andrews
- Smith William E. clerk, 32 Exchange, house 81 Troup [house do.]
- Smith William G. stairbuilder, 4 Caspar,
- Smith William H. blacksmith, Brown cor. Jones, house 15 Jones
- Smith William H. removed from city
- Smith William J. shoemaker, 77 N. Water, boards 12 do.
- Smith William S. depot master, N. Y. C. R. R. 157 State, house 22 North avenue
- Smith William S. jr. civil engineer, boards 22 North avenue [33 University av.]
- Smith Winfield S. supt. Powers' bldgs. bds. Smith & Chester (*J. R. Smith and Thos. Chester*), millers, Frankfort Mills, Mill foot Brown
- Smith & Poppy (*J. C. Smith and J. H. Poppy*), stoves and tinware, 72 West avenue

HENRY C. WISNER,

CRYSTAL BUD VASES, EPERGNES, ETC.,
No. 33 STATE STREET.

Smith, see Schmidt and Schmitt
 Smitzer Mary, trimmer, boards West Maple near Orchard [12 Bauer
 Smy John R. harnessmaker, 241 State, house
 Smyles John, physician, 62 E. Main, boards Culver near Webster road [Jennings
 Sneikel Wm. teamster, h. Swinnerton near
 Snell Anthony, engineer, Court st. bridge, h. Mt. Vernon av. cor. Whitmore park
SNELL EDWARD P. & CO. coal, 48 Hudson, boards 4 Clinton place.—See page 599
 Snell F. A. fur dealer, boards Ayers' Hotel
 Snell Henry J. planer, Court st. bridge, h. 10 Whitmore park
 Snell Jacob H. cartman, h. 18 St. Joseph
 Snell John J. student, University of Roch. boards 4 Lowell
 Snell Mary A. widow, house 4 Lowell
 Snell Nelson, clergyman, h. 4 Clinton place
 Snell Wesley D. real estate, 3 Front, h. Dake
 Snell, see Schnell
 Snider Augustus, turner, house 1 Saxton
 Snider Enos, turner, Jay c. canal, h. 1 Lind
 Snider James, driver, steamer No. 4, house 21 South Ford [Lind
 Snider John H. machinist, 3 Canal, house 1
 Snider John H. hackman, 171 State, house 9 Otsego
 Snider John P. removed to Syracuse
 Snooks Clarissa C. widow, house 19 Jones
 Snow Albert F. student, University of Roch. boards 20 North
 Snow Emma, Mrs. dressmaker, bds. 15 Jay
 Snow John & S. hardware, 79 State, house at Ogden [mouth av.
 Snow Samuel (*J. and S. Snow*), house 83 Ply-
 Snyder Andrew B. boards 28 S. Clinton
 Snyder Bennett, car driver, house 222 State
 Snyder Chester W. bookkeeper, 128 Powers' bldgs. boards 47 Frances [avenue
 Snyder Christiana, widow, b. 107 Caledonia
 Snyder Edward, coachman, 3 Livingston pl. boards West alley n. Troup
 Snyder Elmore W. agent, house 47 Frances
 Snyder Francis, blacksmith, h. 30 Vienna
 Snyder Frank, carpenter, h. 24 University av.
 Snyder Geo. W. piano tuner, 82 State, h. 68 Caledonia avenue
 Snyder Geo. W. carpenter, house 44½ Kirk
 Snyder Gorham, bartender, Congress Hall, boards do.
 Snyder Hannah, widow, bds. 28 S. Clinton
 Snyder Jane, widow, h. Pine al. n. Troup
 Snyder John B. (*Snyder & Meyer*), house 28 University avenue [183 Alexander
 Snyder Joseph, salesman, 112 State, house r.
 Snyder Joseph H. chairmaker, lower falls, h. Third near Glenwood avenue
 Snyder Josephine, boards 37 North avenue
 Snyder Marinda, removed to Buffalo
 Snyder Martin P. removed from city
 Snyder Richard P. deceased, October, 1875
 Snyder Royal, painter, 115 S. St. Paul, house 20 Warehouse
 Snyder Susan, widow, house 28 Litchfield
 Snyder TenEyck D. agent, h. 28 S. Clinton
 Snyder W. Henry, driver, h. West alley near Troup

Snyder & Meyer (*J. B. Snyder and C. C. Meyer*), stoves, &c. 48 East Main
 Snyder, see Snider and Schneider
 Soahner John, laborer, house 27 Childs
 Sodeman Charles, laborer, house 33 Mark
 Soder John, removed to Utica
 Soeder John, salesman, 44 East Main, house 31 Gorham
 Soehner Valentine, tailor, h. 226 St. Joseph
 Sollner Charles F. H. trunk maker, ft. Rowe, boards 332 State
 Solomon Eliza, widow, h. Bloss c. Fulton av.
 Solomon Johanna, widow, b. 21 Clinton pl.
 Solomon Morris E. house 4 Chatham
 Sommer Adam, laborer, h. 100 Pinnacle av.
 Sommer Amelia, tailorress, b. 120 W. Maple
 Sommer August, nurseryman, boards 100 Pinnacle avenue [Wilder
 Sommer Augustus, sawyer, 92 Allen, h. 134
 Sommer John, gardener, h. Ames n. West av.
 Sommerville Peter, moulder, Brown's race n. Furnace, h. 33 Orchard [Chatham
 Sontag Ferdinand, 7 North Clinton, house 24
 Sontag W. G. merchant tailor, 7 N. Clinton, house 24 Chatham
 Soper George H. finisher, 155 N. Water, h. 5 Drayton [over
 Sorgen Gottfried, shoemaker, boards 18 Hansork Henry, laborer, house 64 Bartlett
 Sornborger Caroline P. deceased, Nov. 1875
 Sornborger Dwight C. overseer, M. C. Penitentiary, house 38 Cypress
 Sornborger Edwin, wool, h. 5 Centre park
 Sornborger Edwin C. engineer, b. 5 Centre park
 Sornborger Libbie Miss, copyist, boards 451 Brown [bds. 5 Centre pk.
 Sornborger Wm. A. telegrapher, 151 State,
 Soule Asa T. prest. Hop Bitters Co. 50 Mill, boards 31 Fitzhugh
 Soule A. Miss, boards 170 West avenue
 Soule Wilson, secy. Hop Bitters Co. 50 Mill, boards 31 Fitzhugh
SOURS WILLIAM H. confectionery and ice cream, 101 East Main, house do.—See page 560
 South George, removed from city
 South Wm. saloon, 65 Front, house do.
 South Wm. jr. varnisher, 73 State, boards 65 Front [Griffith
 Southall John (*Southall & Cook*), boards 62
SOUTHALL & COOK (*J. Southall and C. S. Cook*), undertakers, and undertakers trimmings and varnish, 116 Front.—See page 611
 Southard Gustavus V. upholsterer, 184 State, house 3 Costar near Frank
 Southard James P. sawyer, h. 3 Costar near Frank [Hudson c. Woodbury
 Southard James T. upholsterer, 184 State, h.
 Southgate Fred. M. printer, 23 W. Main, h. 70 North avenue [b. 49 Vienna
 Southgate Herbert J. printer, 23 West Main,
 Southgate Wm. miller, house 49 Vienna
 Southwick Charles, baggageman, bds. 100 Mill
 Southwick Clara Miss, boards East avenue cor. Alexander

- Southwick Dyer C. bookkeeper, 80 State, b. Chili road near West avenue
 Southwick Frederick S. dentist, 14 State, b. 32 Culver park [Culver park
 Southwick Hamilton, nurseryman, house 32
 Southwick Johnson M. carriage maker, h. Chili road near West avenue
 Southwick Lucius, gardener, house Culver n. Leighton av. [b. 32 Culver park
 Southwick Millard F. clerk, 128 Powers' bldgs.
 Southwick Theron T. (*Bentley, Meyer & Southwick*), r. Mt. Hope av. opp. Comfort, house 19 Upton park
 Southworth Eliza, widow, boards 69 East av.
 Southworth Herman S. salesman, house 12 Cypress
 Southworth John B. (*Warrant & Southworth*), 26 S. St. Paul, house 69 East avenue
 Southworth J. Allen, bookkeeper, T. B. Yale's, Brighton, boards 69 East avenue
 Southworth Lucinda, widow, b. 31 Tremont
 Southworth Sidney, car driver, h. 226 State
 Spacher Gertrude, widow, house 5 Rauber
 Spacher John, whip maker, Allen n. North Washington, house 7 Rauber
 Spafford Charles A. clerk, 48 State, boards 103 Plymouth avenue
 Spafford James D. carpenter, h. 27 Weld
 Spafford James D. jr. carpenter, house 91 N. Union [Plymouth av.
 Spafford Wm. H. clothing, 48 State, h. 103
 Spahn Andrew, deceased, Dec. 1, 1875
 Spahn Henry, saloon, 6 Mill, house do.
 Spahn Henry, switchman, Lyell st. crossing, house Lyell near R. R.
 Spahn Jacob, lawyer, 49 Arcade, h. 6 Pitt
 Spahn John, shoemaker, 127 E. Main, house 23 Thomas
 Spahn John A. laborer, house 26 Lime
 Spahn John G. shoemaker, 84 S. St. Paul, h. 76 Saxton
 Spahn John J. harness maker, 1 Walbridge's block, boards Lyell near R. R.
 Spahn Joseph, tinsmith, 328 State, bds. Lyell near R. R.
 Spahn Louis, student, boards 6 Pitt
 Spahr Caspar, saloon, 137 State, house do.
 Spang Michael, teamster, Atwater cor. N. St. Paul, h. 50 Lyell [Paul, b. 97 Smith
 Spang Peter, teamster, Atwater cor. N. St.
 Sparks Frank, mason, house 26 Moore
 Sparks Newman G. coachman, house Ninth near Rowe
 Sparks Theodore W. agent, boards 6 Greig
 Sparks Warren, painter, house 6 Greig
 Sparr Chas. J. saloon, Bay n. Goodman h. do.
 Sparr John, tailor, bds. Bay near Goodman
 Spath Leonard J. laborer, Brown c. Jones, house 95 Campbell
 Spaulding Burns (*Spaulding & Martin*), 114 Plymouth avenue, house 43 Atkinson
 Spaulding Caroline, dressmaker, 43 Atkinson, house do.
 Spaulding Chas. J. rem'd to Philadelphia, Pa.
 Spaulding Edward A. deputy sheriff, Court House, house 88 West avenue
 Spaulding Silas W. real estate, house 65 Fulton avenue
- S PAULDING & MARTIN** (*B. Spaulding and Wm. Martin*), shoemakers, 114 Plymouth avenue.—*See page 577*
 Spear James B. livery stable, 4 Franklin, b. 10 Stillson [h. 10 Tappan
 Speare Merrill R. physician, 100 North av.
 Spears David W. teamster, State cor. Platt, house 7 Costar
 Spears Isaac, policeman, City Hall, house 36
 Spencer
 Spears James, servant, Osburn House
 Spears William, boarding house, h. 23 Jay
 Speckscoe John, laborer, Brown's race near Furnace, house 2 Elizabeth place
 Speed James, removed to N. Y. city
 Speers Frank, stitcher, boards 72 Jay
 Speers Frank A. h. Monroe av. c. Goodman
 Speidel Jacob, shoemaker, house 32 Lyell
 Speier Caspar, laborer, house rear 29 Hill
 Speis Charles, removed to Le Roy
 Speis Christian, cabinetmaker, Jay cor. Erie canal, house 21 Clarissa [nursery
 Speis Henry, laborer, house Mt. Hope av. n.
 Speis Jacob, laborer, house 18 Wait
 Speis Mary, deceased December 1875
 Speis Raymond, carpenter, house 14 Grand
 Spelter George, laborer, h. 204 Pinnacle av.
 Spencer Augustus S. carpenter, b. 340 State
 Spencer Burrall, vice pres. Roch. Iron Mfg. Co. 33 Mill, and (*Hunn, Spencer & Co.*), boards Congress Hall
 Spencer Emily, widow, house 5 Anson park
 Spencer Frank, painter, 16 Stone, boards 38 South St. Paul
 Spencer Harriet J. widow, house 131 State
 Spencer Horace, house 99 South St. Paul
 Spencer James E. & Co. (*W. R. Hallowell, E. P. and I. Willis, and J. W. Robins*), lumber, 21 Plymouth av. house 27 South av.
 Spencer John A. (*Spencer, Stalker & Clinch*), house 9 East avenue [bds. 142½ do.
 Spencer J. Civilian, artist, 155 West Main,
 Spencer Luther C. house 4 Stillson
 Spencer Samuel M. (*Hunn, Spencer & Co.*), 74 State, house 21 East avenue
 Spencer Sarah M. Mrs. bds. 7 Greenwood av.
 Spencer, Stalker & Clinch (*J. A. Spencer, W. Stalker and P. Clinch*), stoves and tinware, 104 East Main
 Spencer William F. clerk, b. 27 South av.
 Spencer Wm. H. printer, 51 Savannah, h. do.
 Spencer Wm. L. removed from city
 Spencer W. Hart (*Robert D. Kellogg & Co.*), 192 State, house at New York city
 Spengler John, clerk, 90 West Main, house 39 King
 Sperber Louis C. shoemaker, house 7 Jay
 Sperl Bartael, house Childs near Wilder
 Sperl Maggie Miss, stitcher, bds. 104 Orange
 Sperl Mary Miss, stitcher, boards 104 Orange
 Sperl Michael, shoefitter, 75 N. Water, house 277 Brown
 Sperry James H., Rochester Axle Co. 154 North Water, house 57 Hickory
 Sperry Sarah M. widow, boards 1 Pearl
 Spices L. E. Mrs. widow, boards 39 Saxton
 Spiegel Catharine, widow, h. 139 Pinnacle av.
 Spiegel Jacob, farmer, house Jennings

Spiegel Jacob J. cabinetmaker, 184 State, h. 13 University avenue
 Spiegel Peter, engineer, b. 139 Pinnacle av.
SPIEHLER ADOLPHUS, manufacturing perfumer, 24 E. Main, house 1 Cataract —See page 668
 Spielmann Bernard, safemaker, 188 State, house 45 Weld
 Spies Francis J. tailor, house 62 Campbell
 Spies George, brewer, 106 N. Clinton, b. do.
 Spies Henry (*Reisky & Spies*), 111 North St. Paul, house do.
 Spies Joseph, clerk, house 37 Baden
 Spies Kate, domestic, b. Goodman c. E. Main
 Spiesberger Theresa, widow, h. Jay c. Moulson
 Spietznagel Andrew, carpetlayer, house 123 North Clinton
 Spietznagel Joseph, cutter, house 20 Martin
 Spilberg Harmon, nurseryman, house 13 Goodman [Furnace, bds. 205 State
 Spillane Dennis, moulder, Brown's race n. Furnace, boards 205 State
 Spillane Henry P. moulder, Brown's race n. Furnace, boards 205 State
 Spillane James, carver, bds. 110 Kent alley
 Spillane Jeremiah, moulder, Brown's race n. Furnace, house 7 Warehouse
 Spillane John, laborer, Brown's race near Furnace, house 1 Vought [Lyell
 Spillane Paul, dyer, Mill c. Platt, h. Oak n.
 Spillane Thomas, laborer, house 26 Gregory
 Spillman Frederick, harness maker, 244 East Main, house 248 do.
 Spillman Frederick jr. harness maker, 65 State, boards 248 East Main
 Spindler Henry, cooper, 65 North Water, h. 67 Nassau [house do.
 Spindler Philip H. door manuf. 65 Nassau,
 Spinning Benjamin, tallyman, Erie Railway freight house, boards 6 Ely
 Spinning George E. laborer, Erie Railway freight house, h. 2 Mumford
 Spinning Henry A. compositor, 23 W. Main, house 33 Clifton [30 Martin
 Spinning James B. printer, 23 West Main, h.
 Spinning John N. tailor, 128 W. Main, house 33 Frost avenue
 Spitz Jacob, moulding maker, b. Ames n. Jay
 Spitz John, carpenter, 21 Warehouse, house Jay corner Childs
 Spitz Louis, teamster, house Ames near Jay
 Spitz Peter, sashmaker, 13 Warehouse, bds. Ames n. Jay [h. 123 N. Clinton
 Spitznagel Andrew, carpet layer, 37 State,
 Spitznagel Frank X. machinist, Brown's race near Furnace, boards 12 Catharine
 Spitznagel Joseph, cutter, 46 Mill, house 20 Martin
 Spitznagel Mathilda Miss, vest maker, b. 12 Catharine [32 Channing
 Splain James H. teamster, 55 Front, house
 Splon John, truckman, house 52 Tremont
 Spohr Louis F. flour and feed, 126 E. Main, house 11 Rome
 Spooner Katharine M. D. Miss, organist, b. St Mary's Hospital [Hospital
 Spooner Mary Ann Mrs. boards St. Mary's
 Spoor D. Adelbert, tinsmith, 71 State, house 23 Stone

Spoor Marion, dressmaker, 23 Stone, bds. do.
 Spoor Mary, widow, house 23 Stone
 Sprague Addison, laborer, h. 74 Pinnacle av.
 Sprague Albert A. carpenter, bds. 132 Meigs
 Sprague Alfred, steward, bds. Lake avenue near Lake view park
 Sprague Austin V. M. can opener manuf. 89 North Water, bds. 84 East avenue
 Sprague Benjamin F. carpenter, b. 1 Spencer
 Sprague Can Opener Co. 89 North Water
 Sprague Charles H. agent. house 61 Frank
 Sprague Edwin B. conductor, N. Y. C. R. R. house 70 Atwater
 Sprague Foster, 89 North Water, house 14 Chatham [20 1/2 Hamilton place
 Sprague George H. agent, 11 Mumford, h.
 Sprague George W. bookkeeper, 5 Powers' bldgs. house 42 Vick park
 Sprague James, peddler, house 132 Meigs
 Sprague Jas. W. teamster, h. Lewis n. Meigs
 Sprague Jasper, teamster, b. 74 Pinnacle av.
 Sprague Jesse, miller, 5 Aqueduct, h. 41 Court
 Sprague Lewis, coachman, h. 266 South av.
 Sprague Lorenzo, yardman, Exchange cor. Spring, house Lewis near Meigs
 Sprague Myron W. salesman, bds. 16 James
 Sprague Nathan, house 68 Hamilton place
 Sprague O. Clark, physician, 152 Powers' bldgs. house 208 Exchange [Orchard
 Sprague Richard M. switchman, house 21
 Sprague Samuel A. carpenter, 10 S. Water, house 89 Weld [85 Pinnacle av.
 Sprague Soloman, teamster, 50 Exchange, h.
 Sprague William, teamster, house Lewis
 Sprague William H. laborer, house 132 Meigs
 Spreiter Simon, shoemaker, house 22 Tappan
 Spring Francis, farmer, h. Culver n. Webster road [h. 32 Meigs
 Springer Arthur G. coal, 177 South St. Paul,
 Springer Arthur W. clerk, 177 S. St. Paul, boards 32 Meigs [h. 19 Wilder
 Springer Herman, optician, 179 N. St. Paul,
 Springer Herman G. upholsterer, boards 19 Wilder
 Springer Wells, house 32 Meigs
 Springstead Mary H. widow, bds. 10 Marion
 Springstead Theodore F. machinist, foot Centre, h. Vincent place near Lake av.
 Sproat James, foreman, 134 Mt. Hope avenue, house 61 Cypress
 Sproat John, gas fitter, boards 61 Cypress
 Sproull Robert D. pastor Ref. Presbyterian church, house 10 South Union
 Sprung William A. engineer, house 9 King
 Spurr Henry, forwarder, h. 24 Edinburgh
 Spurr Louis H. nickel plater, Court cor. Stone, house 6 George
 Squier Caroline M. widow, bds. 64 Andrews
 Squire Charles T. watchman, house 18 Scio
 Squier Dwight, collector, house 64 Andrews
 Squires Anna E. Miss, hairworker, boards 275 State
 Squires James D. student, University of Rochester, boards 82 East avenue
 Squires James E. machinist, Brown c. Jones, house 88 Adams [3 Favor
 Squires John J. blacksmith, 57 West av. bds.
 Squires Nelly Miss, boards 110 Broadway

- Squires Pamela, widow, house 275 State
 Stace Rebecca, widow, house Fulton avenue
 corner Emerson
 Stace Wm. A. bds. Fulton av. cor. Emerson
 Stacey Rufus R. painter, 9 W. Main, house 16
 Hickory
 Stack John, saloon, 160 State, house do.
 Stacy Gratia, widow, house 16 Hickory
 Stade Charles, carpenter, boards 177 North
 Stade Frederick jr. clerk, North c. Woodbury,
 boards 177 North [av. h. 177 do.
 Stade Frederick & Co. carpenters, 172 North
 Stade John, carpenter, boards 177 North
 Stadler Frederick, shoemaker, 270 State, h.
 23 Canal [Galusha
 Stadler Geo. engineer, 139 N. St. Paul, h. 26
 Stadler Levi, clerk, 147 State, bds. 23 Canal
 Stadt Augusta, widow, boards 189 Scio
 Stadt John, laborer, house 189 Scio
 Stafford Aloys Mrs. h. r. N. Clinton n. Norton
 Stafford Emily, widow, h. Lyell n. railroad
 Stafford John, physician, 86 South av. h. do.
 Stafford Thomas, laborer, house 289 Jay
 Stafford Wm. tailor, 128 State, b. 9 S. Ford
 Stafford William, removed to Clyde
 Stafford William, boards City Hospital
 Stafford Wm. A. sawyer, house 7 Alexander
 Stahl Conrad, salesman, Court street bridge,
 house 38 Martin
 Stahl Eva Miss, boards 38 Martin
 Stahl Frank J. engineer, 111 State, house 22
 Lowell
 Stahl Magdalene, widow, h. 313 N. Clinton
 Stahl Martin H. grocer, 143 South av. h. do.
 Stahl Matthias, shoemaker, 92 State, b. 156
 N. Clinton [15 W. Troup
 Stahl Peter N. telegrapher, Platt cor. Kent, b.
 Stahlbrodt Christian A. cigar manuf. 91
 Chatham, house do.
 Stahlbrodt Minnie, widow, h. 5 Sheridan pk.
 Stahlbrodt Paul, clerk, 103 Hudson, boards
 5 Sheridan park
 Stahleker John, blacksmith, h. 63 Morgan
 Stahleker Phillip, deceased April, 1876
 Stahley Cassimer, hairdresser, 98 Front, h.
 124 North avenue [5 Franklin sq.
 Stahley Frederick A. trimmer, 72 Mill, bds.
 Stahley Gledis K. clerk, 72 Mill, b. 36 Gibbs
 Stahley Joseph A. cutter, 72 Mill, b. 36 Gibbs
 Stahlhut Henry, grocer, 36½ Gregory, h. do.
 Stahlhut William, laborer, house 2 Bartlett
 Stahli Albert, laborer, 61 Frances, bds. Cady
 corner Seward
 Staker David, nickel plater, Court cor. Stone,
 boards 124 Chatham
 Staley Caroline, widow, house 25 Adams
 Staley Frederick, salesman, b. 5 Franklin sq.
 Staley Harry E. clerk, 10 State, b. 25 Adams
 Stalker Geo. H. bookkeeper, Aqueduct, h.
 150 Scio
 Stalker Isaac, tanner, house 150 Scio
 Stalker James, carpenter, Joiner n. Kelly, h.
 12 Pryor [38 Joiner
 Stalker Robert, policeman, City Hall, house
 Stalker Thomas H. skindresser, 13 North
 Water, house 51 Tyler
 Stalker William (Spencer, Stalker & Clinck),
 104 E. Main, boards 150 Scio
- Stallknecht Anselm, blacksmith, house 160
 Pinnacle avenue [h. 228 W. Main
 Stallknecht August (Hesslinger & Stallknecht),
 Stallknecht Joseph, saloon, 80 Front, h. do.
 Stallknight Adam, salesman, 186 State, h.
 41 Asylum
STALLMAN BROS. (H. and F.P. Stallman),
 masons and contractors, 251 N. St. Paul
 and 78 Cady.—See page 633
 Stallman Frederick P. (Stallman Bros.),
 mason, 78 Cady, house do.
 Stallman Henry (Stallman Bros.), mason, 251
 N. St. Paul, house do. [Frances
 Stallman Jacob, carpenter, b. Magnolia near
 Stallman John, at Vacuum oil works
 Stallman Louise, widow; house Magnolia n.
 Frances
 Stallman Mary, grocer, 73 Adams, house do.
 Stalter Henry, miller, Whitney Mills, boards
 42½ North avenue [way n. Howell
 Stamborski Anthony, laborer, house Broad-
 Standish Ella Miss, house 5 Plymouth av.
 Standish Emma A. saloon, 67 Exchange,
 house do. [vent, Frank cor. Jay
 Stanislaus Sister Superior, Nazareth Con-
 Stanley Amelia, teacher, Norton School No.
 2, boards 6 Harris avenue
 Stanley Annie M. Mrs. dressmaker, 26 Hud-
 son, house do. [119½ do.
 Stanley Geo. W. salesman, 13 E. Main, bds.
 Stanley Hoyt, musician, h. Harris avenue n.
 Clifford
 Stanley James B. removed from city
 Stanley James W. h. South av. c. Stanley
 Stannard Charles E. salesman, 41 E. Main,
 house 19 W. Troup [Canandaigua
 Stannard —; salesman, 87 Front, h. at
 Stanton Daniel, removed to Binghamton
 Stanton Elizabeth, teacher, b. 36 Adams
 Stanton George, boards 37 Adams
 Stanton Henry, boards 37 Adams
 Stanton John, laborer, h. r. 18 Mt. Hope av.
 Stanton John W. salesman, 7 W. Main, h.
 18 Warner
 Stanton Moses L. house 111 Monroe avenue
 Stanton Patrick, saloon, 12 Platt, house do.
 Stanton Susan W. widow, house 37 Adams
 Stanton Thomas, laborer, h. 4 George's park
 Stanton Thomas C. jeweler, bds. 36 Adams
 Stanton William A. student, Rochester Theo-
 logical Seminary, b. Trevor Hall
 Stanton Wm. P. jeweler, house 36 Adams
 Stape John, house Finney c. Tyler
STAPE JOHN, liquors and cigars, 104
 East avenue, h. do.—See page 556
 Stapler Henry, cartman, house 40 Bartlett
 Stapler Mary, widow, boards 40 Bartlett
 Staples Albert, carpenter, house 74 North av.
 Staples Hannah R. widow, bds. 6 Romeyn
 Staples Harry A. music teacher, 16 E. Main
 house 40 Allen
 Staples Mary, rubber shoemaker, b. 6 Romeyn
 Staples Winfield S. lawyer, 109 Arcade, h.
 30 Pearl [Frost av.
 Stapleton Michael, laborer, gas works, h. 32
 Starbuck Alexander B. bookkeeper, 37 State,
 bds. 1 Lamberton park
 Starbuck Edwin S. clerk, b. 1 Lamberton pk.

HENRY C. WISNER,

BACCARAT TABLE DE SERVICE,
No. 33 STATE STREET.

Starbuck Eliza, widow, h. 1 Lamberton pk.
 Stark Frank I. foreman, 30 West av. boards
 Troup n. Genesee Valley canal [h. do.
 Stark Henry P. insurance agent 18 E. Main,
 Stark Herbert, agent, bds. 18 East Maine
 Stark Mary E. Miss, dressmaker, house 29
 South Ford [North Clinton
 Stark Wm. cutter, 64 Mill, house Flower n.
 Starr Raymond T. cutter, 2 W. Main, house
 83 Troup
 Starr Samuel A. turner, bds. 6 Hubbell pk.
 Start George, fireman, bds. 24 North avenue
 Start Hartwell, engineer, N. Y. C. R. R. h.
 24 North avenue
 State Thomas, blacksmith, 3 Canal, boards
 80 West avenue [b. 39 Kirk
 Staub August, leather finisher, 23 N. Water,
 Staub Catharine, tailoress, house 48 Martin
 Staub Christian, tailor, boards 54 Lowell
 Staub Clements, clerk, 25 Mill, h. 27 Oakman
 Staub Dominick, carpenter, house Hudson
 corner Clifford
 Staub Ferdinand, laborer, house 39 Kirk
 Staub Jacob, cutter, 72 Mill, h. 60 North av.
 Staub Jacob, student, Rochester Theological
 Seminary, b. 118 Alexander
 Staub Lugarde, widow, house 54 Lowell
 Staub Roman, mason, house 54 Lowell
 Staublin George, mason, house 52 Charlotte
 Stauch Adam J. cabinet maker, 71 N. St.
 Paul, house 3 Oakman
 Staud Charles, cigar maker, 106 Allen, h. do.
 Staud Geo, C. cigar maker, 106 Allen, h. do.
 Staudenmaier John, saloon, 175 N. Clinton,
 house 76 Joiner [b. 55 Whitney
 Staudenmayer Joseph U. cooper, 5 Thompson,
 Stauder William, carpenter, h. 18 Edward
 Staudinger Charles, fence maker, 188 State,
 house Clifford near Maria
 Staudinger Victor, safe maker, 188 State, b.
 Clifford n. Maria
 Stauff Jacob G. shoe cutter, 55 Mill, b. Web-
 ster road n. Goodman [Goodman
 Stauff John, laborer, h. Webster road near
 St. Clair Dennis, gardener, h. 24 N. Union
 St. Clair Joseph, waiter, Osburn House
 St. Clair Joshua F. agent, b. 24 N. Union
 St. Clair Robert, driver, 62 Sophia, b. do.
 St. Clements free reading room, 40 Hickory
 St. Cyr Joseph Z. shoemaker, 111 State, h.
 98 N. St. Paul
 Stearns Henry, boards 114 Lake avenue
 Stearns Nellie M. Mrs. teacher, Real Schule,
 7 Mortimer, bds. 46 Edinburgh
 Stearns Wm. H. bookkeeper, 22 E. Main, h.
 46 Edinburgh [13 Hamilton place
 Stebbins Emily L. Mrs. artist, h. and studio
STEBBINS FRANKLIN S. at Johnston
 Harvester Co's, at Brockport, house 13
 Hamilton place.—*See page 695*
 Stebbins John W. lawyer, 100 Powers' bldgs.
 house 5 Chestnut
 Stebbins Mary E. widow, h. 15 N. Clinton
 Stebbins William, house 13 Hamilton place
 Stecher Charles, lithograph printer, 7 Market,
 house 15 McDonald avenue
 Stecher Frank A. (*Mensing, Rahn & Stecher*),
 7 Market, house 128 Frank

Stecher Philip W. boards 73 St. Joseph
 Stecher Wilhelmina A. widow, b. 73 St.
 Joseph
 Stecker Jacob, chairmaker, house 14 Grand
 Steckel John, shoemaker, house 78 Orange
 Steckel John jr. varnisher, 184 State, bds. 78
 Orange [boards 78 Orange
 Steckel Matthias, shoemaker, 75 N. Water,
 Stede Margaret, widow, house 14 Pitt
 Stedman George, coachman, boards 105 Mill
 Stedman J. Harry (*E. H. Cook & Co.*), 11
 Exchange, boards 29 Spring [Union
 Steehler Caspar, engineer, house 85 South
 Steel Charles M. clerk, 92 State, b. 21 Marietta
 Steel Henry, mason, bds. 159 North Clinton
 Steel Joseph, mason, house 159 N. Clinton
 Steel Martha A. widow, b. Clifford n. North
 Clinton [Marietta
 Steel Matthew J. foreman, 55 Mill, house 21
 Steele Chas. E. postal clerk, N. Y. C. R. R.
 boards 24 Centre
 Steele Frank, grocer, Allen c. N. Washing-
 ton, b. 72 Oak
 Steele George, boot treer, house Lewis
 Steele Isaac H. (*Steele & Co.*), bds. 43 E. Main
 Steele James P. silversmith, 1 Aqueduct, h.
 236 Exchange
 Steele Mary E. widow, bds. 16 Chestnut pk.
 Steele Robt. J. (*Steele & Co.*), b. 43 E. Main
 Steele Samuel C. (*Steele & Avery*), 44 State,
 house 10 North Washington
 Steele Wm. blacksmith, house 72 Oak
 Steele William H. salesman, 112 State, house
 196 Oak
STEELE & AVERY (*S. C. Steele and S. S.*
Avery), booksellers and stationers, 44
 State.—*See page 519*
 Steele & Co. (*I. H. and R. J. Steele*), spring
 bed manufs. 43 East Main
 Steen A. Frederick, removed from city
 Steen Knud, painter, 6 Plymouth av. house
 12 South Ford
 Steenburg Lena, boarding house, 4 North
 Washington, house do.
 Stefel Bernard L. agent, boards 25 Oregon
 Stefel Joseph L. salesman, boards 25 Oregon
 Stefel Lipman, house 25 Oregon [Oregon
 Stefel Simon L. bookkeeper, 40 State, b. 25
 Stefenhagen Chas. laborer, h. 34 German av.
 Stefenhagen Ernest, laborer, house 12 Bay
 Steffene Frederick, teamster, h. 19 Webster
 Steffler Frederick, watchman, Exchange opp.
 Glasgow, house Cypress
 Steffler Louis, wiper, Exchange opp. Glas-
 gow, house 139 Caledonia avenue
 Steger Christopher, laborer, h. 47 Wilder
 Steger David E. lockmaker, b. 124 Chatham
 Steger George, laborer, house 31 Comfort
 Steger John B. tailor, 223 Brown, house do.
 Steger Rosina, widow, house 124 Chatham
 Steger Teresa, clerk, Brown c. W. Maple, b.
 288 Brown
 Steger Wolfgang, butcher, house 288 Brown
 Stehle Albert, laborer, house 10 Pitt
 Stehle Andrew, tailor, house 36 Gibbs
 Stehle Frank A. gardener, h. r. Ulm n. Bay
 Stehle Frederick, clerk, boards 36 Gibbs
 Stehle Joseph, cutter, boards 36 Gibbs

Stehle Joseph F. lockmaker, Court c. Stone, h. Bay n. Fourth av. [85 S. Union
Stehler Caspar, engineer, 71 N. St. Paul, h.
Stehler George, butcher, h. Scramton near
N. Clinton [boards 85 Kelly
Steidle Frederick M. tinsmith, 263 State,
Steigewald Louis, flagman, house 15 Kondolf
Steimer Joseph, carriage trimmer, house 70
Maple
Steimes John, plasterer, bds. 47 W. Maple
Steimes Joseph, shoemaker, 270 State, b. 47
W. Maple [b. 47 West Maple
Steimes Lawrence, machinist, 15 Warehouse,
Steimes Nicholas, plasterer, h. 47 W. Maple
Stein, Adler & Co. (*N. Stein, L. and A. Adler
and L. Bloch*), clothing, 14 Mumford
Stein Andrew, mason, house 2 Oakland park
Stein Christian, boxcutter, 50 Mill, house 15
Sellerger
Stein Christian, mason, house 22 Morris
Stein Gottlieb G. peddler, house 85 Chatham
Stein John, carpenter, h. Frances n. Magnolia
Stein John, clothing, 6 Wilder, house do.
Stein Julius, assistant bookkeeper, Exchange
cor. Court, boards 41 Franklin
Stein Leopold, bookkeeper, Exchange cor.
Court, boards 41 Franklin
Stein Louis N. salesman, boards 12 Gibbs
Stein Mary, widow, house 3 Emmett
Stein Nathan (*Stein, Adler & Co.*), h. 12 Gibbs
STEIN SAMUEL, burial caskets and show
cases, Exchange cor. Court, h. 41 Frank-
lin.—*See page 621*
Stein Show Case Works, Exchange c. Court
Steiner Verena, widow, h. r. 13 Jackson
STEINFELD EDWARD, clothing and mer-
chant tailor, 15 E. Main, house 5 South
Union.—*See page 543*
Steinfort John J. b. Conkey av. c. Clifford
Steinhart Myer C. confectioner, 39 Exchange,
boards 171½ East Main
Steinhauer August, tailor, boards 17 Grand
Steinhauer George, carpenter, house 17 Grand
Steinhauer George, pressman, 82 W. Main,
boards 17 Grand
Steinhauer George, house 69 Nassau
Steinhauer Henry, mason, house 62 Nassau
Steinhauer John, cabinetmaker, 184 State, b.
17 Grand [house 20 Herman
Steinhauer Jacob, blacksmith, 51 North av.
Steinhauer William J. machinist, Brown c.
Jones, house 16 Herman
Steinheiser Adam, blacksmith, house 54 Kirk
Steinheiser Agnes Miss, clerk, b. 14 Univer-
sity avenue [University avenue
Steinheiser Conrad, shoemaker, house 14
Steinheiser Elizabeth, milliner, 84 State, bds.
14 University av. [b. 14 University av.
Steinheiser William, upholsterer, 44 E. Main,
Steinkamp William, toolmaker, 120 Mill, h.
at Gates
Steinkoll John, house Ames near Campbell
Steinkoll John jr. varnisher, 184 State, bds.
Ames n. Campbell [North Clinton
Steinle Marie, millinery, 137 E. Main, b. 62
Steinlein Joseph, turner, 179 N. St. Paul, h.
10 Nassau
Steinmann Frederick, news agent, h. 5 Morris

Steinmann Lina, fancy goods, 84 St. Joseph,
boards 86 do.
Steinmueller John, laborer, house 24 Mark
Steinmueller Magdalena, widow, b. 33 Mark
Steirwald Adam, tanner, 87 North Water,
house 65 Baden
Steirwald Michael, removed to Greece
Stellwagen Henry, sashmaker, Aqueduct, h.
77 Hunter
Stellwagen Libbie Mrs. boards 4 Henion pl.
Stellwagen Mary, widow, house 163 Orange
Stellwagen Matthew, toolmaker, h. 32 Grape
Stem Mary, widow, house 13 Hart's block
Stengel Christian, stonecutter, 22 West av.
boards 9 Caledonia av. [b. 90½ Hunter
Stenser Hannah Miss, tailoress, 65 Bartlett,
Stenson Robert, surveyor, house 23 Kirk
Stenzel Chas. F. laborer, h. 257 N. Clinton
Stenzel Gottlieb, stonecutter, house Henri-
etta avenue near Pinnacle ayenue
Stenzel Gustave, blacksmith, h. 90½ Hunter
Stenzel Robert, blacksmith, 3 Canal, b. 90½
Hunter
Stephan John, grocer, St. Joseph c. Buchan
park, house do. [b. 249 N. Clinton
Stephany Charles, gasfitter, 81 East Main,
Stephany Frank, carpenter, house 98 Kelly
Stephany John, saloon, 249 N. Clinton, h. do.
STEPHANY JOSEPH, carpenter and con-
tractor, Holland near Nassau, house 54
Nassau.—*See page 632*
Stephany Joseph jr. carpenter, b. 54 Nassau
Stephens Jacob, cooper, Magne opp. Walnut
house 98 Jay [Favor
Stephens John, salesman, 74 State, house 23
Stephens John, laborer, h. Bowen n. Bates
Stephens Joseph, patternmaker, Mill corner
Factory, h. 149 Wilder [house, b. 98 Jay
Stephens Michael A. sashmaker, 13 Ware-
Stephens Oscar A. foreman, Brown c. Jones,
house 180 Brown
Stephens, see Stevens
Stephenson David, coremaker, Brown's race
n. Furnace, house Michigan near Bauer
Stephenson Edmund, painter, 100 S. St. Paul,
house 46 Tremont
Stephenson Samuel, painter, bds. 46 Tremont
Stephenson, see Stevenson
Ster Louisa, saloon, 103 Jay, house do. [av.
Sterling Alice, dressmaker, b. 72 Mt. Hope
Sterling Charles W. printer, boards 72 Mt.
Hope avenue
Sterling George P. house 72 Mt. Hope avenue
Sterling Lewis T. removed from city
Sterling Mary A. teacher, Tremont School,
No. 3, boards 72 Mt. Hope avenue
Sterly Jacob, machinist, boards 39 Hollister
Stern Abram (*Beir, Stern & Co.*) 66 Mill, h.
11 Clinton place
Stern Herman, salesman, 73 Mill, b. 7 Rome
Stern Israel (*Beir, Stern & Co.*), 66 Mill, bds.
11 Clinton place
Stern Lena, widow, house 13 St. Joseph
STERN LEWIS, wholesale hatter, 73 Mill,
house 7 Rome.—*See page 548*
Stern Max, removed to Philadelphia, Pa.
Stern Morris A. salesman, bds. 11 Clinton pl.
Stern Nathan, deceased January, 1876

Stern Simon (*Wile Bros. & Co.*), 74 Mill, bds. 35 North Clinton [av. h. do.]
 Sterrit Louisa, fancy goods, 110 Plymouth
 Sterrit Robert, house 3 Clark [h. do.]
 Stesel Agnes Mrs. hairworker, 16 Walnut,
 Stesel George R. printer, 23 W. Main, house
 16 Walnut [h. Genesee n. Magnolia
 Stetsel John E. teamster, 21 Plymouth av.
 Stetson Benjamin L. foreman, house 18
 Trowbridge
 Stetson Thomas, mason, house Vick park
 Stettheimer Abraham, removed to N. Y. city
 Stettheimer Jacques R. 8 State, boards 9 S.
 Clinton
 Stettheimer Joseph S. house 19 South Clinton
 Stettheimer Maurice R. (*Stettheimer, Tone &
 Co.*), b. 9 S. Clinton
 Stettheimer Sigmund (*Stettheimer, Tone &
 Co.*), h. 9 S. Clinton
 Stettheimer Simon, boards 9 South Clinton
STETTHEIMER, TONE & CO. (*S. and M.
 R. Stettheimer, T. W. and B. W. Tone*),
 bankers, 8 State.—*See page 501*
 Stetzelberger Chas. carpenter, h. 31 Hollister
 Stetzelberger Charles jr. upholsterer, 184
 State, b. 31 Hollister [mouth av. h. do.]
 Stetzenmeyer Frederick, grocer, 171 Ply-
 Stetzenmeyer Frederick J. clerk, 68 Mill, b.
 65 Bartlett [house do.]
 Stetzenmeyer Jacob F. tailor, 65 Bartlett,
 Steublein Rosina, domestic, boards 8 Pearl
 Steudle John A. tinsmith, 92 St. Joseph, b.
 85 Kelly [house 85 Kelly
 Steudle Michael, moulder, 187 West Main,
 Steul Catharine, widow, b. 99 Pinnacle av.
 Steul Mary, widow, house 99 Pinnacle av.
 Steul William, deceased Febuary, 1876
 Steutel Antonia, widow, bds. 6 Huntington
 Stevens Alvarado (*J. B. Stevens & Son*), h.
 177 State
 Stevens Benjamin E. clerk, boards 30 S. Ford
 Stevens B. Franklin, deliverer, 43 State, h.
 Gilmore near Hudson
STEVENS CHARLES E. druggist, 62 W.
 avenue, house do.—*See page 570*
 Stevens Edward A. printer, house 9 West
 Troup [36 N. Washington
 Stevens Edward Van E. clerk, 50 State, bds.
 Stevens Elizabeth, teacher, 76 Exchange,
 boards 216 University avenue
 Stevens Fanny Miss, house 39 Hill
 Stevens Francis S. mason, h. 115 Frances
 Stevens Frank, chairmaker, house 3 Maria
 Stevens George A. teamster, h. Ashland near
 Gregory [Rochester, b. 35 Chestnut
 Stevens George B. student, University of
 Stevens Holmes B. removed to Clyde
 Stevens Jas. fireman, N. Y. C. b. 67 Nassau
 Stevens James, laborer, house 216½ E. Main
STEVENS JAMES B. & SON (*A. Stevens*),
 boxmakers, foot Centre, h. 173 State.—
See page 535
 Stevens James H. painter, house 131 Meigs
 Stevens John, confectioner, 19 South av.
 house do.
 Stevens John C. baker, house 30 South Ford
 Stevens John E. printer, 43 Orange, boards
 30 South Ford

Stevens John H. whitewasher, h. Pine alley
 near Spring
 Stevens Mary Miss, boards 60 North Clinton
 Stevens Mary J. Mrs. boards East avenue
 corner Alexander [av. h. do.]
 Stevens Nellie A. teacher, 216 University
 Stevens Othello H. lawyer, 50 Powers' bldgs.
 house 216 University avenue
 Stevens Richard J. wood moulder, 184 State,
 house 34 Saratoga avenue
 Stevens Samuel W. market, 132 Plymouth
 avenue, house 33 Greig
 Stevens Sarah Miss, seamstress, b. 63 Troup
 Stevens Sidney A. h. Troup n. Caledonia av.
 Stevens, see Stephens
 Stevenson Arthur, house Field n. Monroe av.
 Stevenson Benjamin, clerk, house 34 Ply-
 mouth avenue
 Stevenson Ebenezer, clerk, h. Jefferson pk.
 Stevenson Edward, removed to New York
 Stevenson Frank B. salesman, 42 State, bds
 Monroe avenue corner Goodman
 Stevenson Fred J. market, 11½ Spring, house
 50 South Ford [n. Pinnacle av.
 Stevenson George, teamster, h. Brighton av.
 Stevenson Hanover, laborer, h. 48 Savannah
 Stevenson James P. D. clerk, 46 East Main,
 boards 22 Monroe avenue
 Stevenson James R. carpenter, house 42 Con-
 cord avenue [Sibley
 Stevenson John, sawyer, house Culver near
 Stevenson John, carpenter, Minerva alley,
 b. 48 Savannah [roe av. n. Goodman
 Stevenson John H. cattle doctor, house Mon-
 Stevenson Joseph, clerk, 73 East Main, bds.
 170½ West Main [h. 30 do.]
 Stevenson Josiah H. bookkeeper, 13 Spring,
 Stevenson Julia M. matron, Monroe Co. In-
 sane Asylum, bds. do. [h. 39 Court
 Stevenson Margaret Z. (*Cottrell & Stevenson*),
 Stevenson Mary J. dressmaker, 7 Cypress,
 house do. [av. cor. Goodman
 Stevenson Morris, clerk, 23 Spring, b. Monroe
 Stevenson Robert, engineer, house 280 State
 Stevenson Samuel, watchman, Exchange op-
 posite Troup, house 7 Cypress
 Stevenson —, salesman, boards 7 Marshall
 Steward George H. & Co. (*Samuel Steward*),
 flour, 199 Monroe avenue, b. 11 Rowley
 Steward James W. shoemaker, 63 Jay, house
 42 Jones
 Steward Samuel (*G. H. Steward & Co.*), 199
 Monroe avenue, house at E. Bloomfield
 Stewart Agnes M. teacher, Tremont School,
 No. 3, boards 127 Caledonia avenue
 Stewart Alexander T. clerk, 16 Exchange,
 boards 6 Perkins
 Stewart Caroline P. Mrs. news rooms, 123
 Plymouth avenue, house do.
 Stewart Charles, clerk, 3 Stone, boards do.
 Stewart Esther, widow, house 15 Stone
 Stewart Fanny D. Mrs. laundress, h. 7 Swan
 Stewart Franklin J. (*J. T. Stewart & Son*), h.
 61 North St. Paul
 Stewart James, shoemaker, Penitentiary, b.
 10 Cypress
 Stewart James, carpenter, Franklin c. North,
 house 19 Charlotte

- Stewart James E. (*Stewart, Woodcock & Co.*),
house McCracken corner First
- Stewart James E. (*Chapman & Stewart*), 10½
Mill, house 15 Stone
- STEWART JAMES T. & SON** (*F. J. Stewart*),
shoe manufs. 1 Andrews, house 42
North St. Paul.—*See page 666*
- Stewart John, shoemaker, bds. 12 Scrantom
- Stewart John, shoemaker, house Norton near
North St. Paul [Schanck av.]
- Stewart John, farmer, house Culver near
Stewart John, teamster, boards 24 White
- Stewart John A. clerk, Bank of Monroe, 22
Exchange, house 6 Perkins
- Stewart John H. salesman, 73 East Main, h.
10 William [Caledonia av.]
- Stewart John L. painter, 51 Front, house 127
- Stewart John P. (*Acker & Stewart*), 77 State,
house 226 North [h. 7 South]
- Stewart John P. pastor, St. Mary's Church,
- Stewart M. Luie, milliner, 81 East Main, b.
34 Pearl
- Stewart Rebecca E. widow, h. 116 Clifton
- Stewart Robert, gardener, house 12 Scrantom
- Stewart Robert, teamster, house 24 White
- Stewart Rubber Co. 1 Andrews
- Stewart Samuel M. carriage manuf. 29 Mum-
ford, house 35 Delevan [av.]
- Stewart William, painter, h. 10 Greenwood
- Stewart William, teamster, 341 State, b. do.
- Stewart William G. carpenter, h. 28 Tappan
- Stewart William H. H. plumber, boards 12
Scrantom
- Stewart William J. ass't surveyor, City Hall,
boards 28 Tappan
- Stewart William J. coachman, bds. 7 Swan
- Stewart William M. bookkeeper, 69 State, b.
Goodman cor. University avenue
- Stewart, Woodcock & Co. (*J. E. Stewart, P.
R. Woodcock and J. M. Critchell*), stoves,
&c., 15 W. Main
- Stewick Christopher, teamster, house Genesee
near Magnolia [33½ Tappan]
- Steyaart Isaac, flour and feed, 94 North av. h.
- Steyaart Peter, clerk, 94 North avenue, h.
24 Clifford
- St. Helens John, carpenter, 23 North Wash-
ington, house 43 Glasgow [381 Brown]
- St. Helens Joseph, policeman, City Hall, h.
- St. Helens Roger, carpenter, h. 18 Campbell
- Stickel Frederick, grocer, 31 Herman, h. do.
- Stickel George, boards 33 Gregory
- Stickle Henry M. salesman, 93 State, house 2
Cobb [avenue]
- Stickle Jeremiah, seed agent, h. 171 Monroe
- Stickle Theodore, machinist, Brown's race
near Furnace, house 38 Frost avenue
- Stickle Thomas, machinist, Mill foot Platt,
house 81 Hunter [avenue]
- Stickle William J. agent, bds. 171 Monroe
- Sticklin Magdalena, widow, house 7 Rauber
- Stickline Lewis (*Ehrlart & Stickline*), 40 Al-
len, boards 173 Brown
- Stickline Rachel, widow, house 51 Orange
- Stickline Valentine, hairdresser, 90 Mill, bds.
51 Orange [h. 49 N. Clinton]
- Stickney Samuel C. jeweler, 32½ Franklin,
- Stief Raymond, carpenter, house 23 Lowell
- Stiefel David, watches, &c. h. 72 St. Joseph
- Stiefel Elizabeth, widow, house 33 German
- Stiefel Frederick, cabinet maker, house 35
German [Joseph]
- Stiefel Joseph D. salesman, 66 Mill, b. 72 St.
- Stiefel Julius J. cutter, boards 84 St. Joseph
- Stiefel Mary, widow, house 84 St. Joseph
- Stiefel William, switchman, N. Y. C. R. R.
house 33 German
- Stiegman John, laborer, house 4 Bay
- Stiehlher Charles, varnisher, 184 State, house
325 N. Clinton
- Stiehler Mathilda, deceased May, 1875
- Stierly Robert, machinist, Brown's race near
Furnace, bds. North av. c. Stevens
- Stierly Samuel, grocer, North avenue corner
Stevens, house do. [101 Saxton]
- Stiffler John, shoemaker, 75 N. Water, bds.
- Stiffler Lawrence, shoemaker, 87 N. Water,
boards 101 Saxton
- Stiffler Michael, shoemaker, h. 101 Saxton
- Stiles Albert C. fireman, Erie R. R. h. 51 Ford
- Stiles David L. house 84 Fitzhugh
- Stiles David L. grocer, 49 North av. h. do.
- Stiles James H. (*W. J. Stiles & Son*), boards
61 Caledonia avenue
- Stiles John R. pictures, h. 3 Woodford place
- Stiles Lorren, student, University of Roch-
ester, boards 17 Mathews
- Stiles Myron H. agent, house 4 St. Clair
- Stiles Philander, boards 4 St. Clair
- Stiles William J. & Son (*J. H. Stiles*), gro-
cers, 61 Caledonia av. house do.
- Stiles, see Styles
- Stille Barbara, widow, house 82 Chatham
- Stillson George D. supt. Mt. Hope cemetery,
house Mt. Hope av. n. Mt. Hope
- Stillson George T. asst. supt. Mt. Hope ceme-
tery, b. Mt. Hope av. n. Mt. Hope
- Stillson Jerome B. house 27 East avenue
- Stilson Una, teacher, Monroe School, No.
15, boards 21 Gardiner park
- Stilwell Albert H. student, University of
Rochester, boards 77 Atwater
- Stilwell Arthur E. printer, boards 21 Rowley
- Stilwell Charles H. clerk, city treasurer's
office, City Hall, house 21 Rowley
- Stilwell Eliza, widow, house 9 Troup
- Stilwell F. W. physician, 90 North av. h. do.
- Stilwell Henry McA. removed to Pittsburgh
- Stirenthaler Joseph, brewer, boards 81 Mill
- Stitt Jane A. widow, boards 24 Trowbridge
- St. Jermain Edward, printer, 82 West Main,
house 59 Caledonia av.
- St. John Alanson, carpenter, h. 23 Alexander
- St. John Charles M. clerk, city assessor's
office, City Hall, house 6 Monroe av.
- St. John Charles R. removed to Wolcott
- St. John George W. millwright, 120 Mill,
boards State
- St. John George W. boards 6 Monroe avenue
- St. John Sister, teacher, boards Jay c. Frank
- St. John William H. lawyer, 106 Powers'
bldgs. boards 68 Chestnut
- St. Joseph's Orphan Asylum, 48 Andrews
- St. Mary's Hospital, West av. cor. Genesee
- St. Mary's Orphan Boy's Asylum, West av.
corner Genesee

HENRY C. WISNER,

COCKSON & CHETWYND'S WHITE GRANITE
WARE, No. 33 STATE STREET.

Stoakes James W. jr. removed from city
 Stober Adam, market, 72 N. St. Paul, h. do.
 Stocher George, gardener, 40 St. Joseph
 Stock Alfred, student, boards 56 East av.
STOCK NICHOLAS, marble dealer, Lake
 N av. opp. Cemetery, house Lake avenue n.
 Little Ridge road.—*See page 559*
 Stock John, cooper, h. Ames n. W. Maple
 Stock Simeon, waiter, Osburn House, house
 107 Scio [Ames n. W. Maple
 Stock Walter, oil finisher, foot Rowe, boards
 Stockbridge, Brayton & Co. (O. Williams),
 boot and shoe manufs. 75 N. Water
 Stockbridge Henry D. (Stockbridge, Brayton
 & Co.), house 7 James
 Stockbridge Hiram R. (Warner, Stockbridge
 & Co.), 18 Arcade, house 135 Alexander
 Stocking Alpha D. deceased Sept. 1875
 Stocking Daniel C. pumpmaker, 101 Alex-
 ander, house 143 Monroe avenue
 Stocking Frank J. painter, b. 143 Monroe av.
 Stocking Jerome, machinist, 138 Mill, house
 54 Kent
 Stocking Maria L. Mrs. h. 38 S. St. Paul
 Stocking Mary, widow, house 143 Monroe av.
 Stocking Solomon, pumpmaker, boards 143
 Monroe avenue [Colvin n. W. Maple
 Stockmeister Frank, edge tool maker, house
 Stockwell Abigail, widow, b. 38 North av.
 Stockwell Eliza J. widow, house 13 Tappan
 Stockwell Jerome N. B. moulder, house 20
 Channing
 Stoddard Alice Miss, boards 123 Alexander
 Stoddard Enoch V. physician, 33 Fitzhugh,
 boards do.
 Stoddard Goodwin (Ellison & Stoddard), 77
 N. Water, house at Brighton [pold
 Stoddard Hiram W. shoemaker, h. 27 Leo-
 Stoddard Oscar, patent rights, house 32 Oak
 Stoddard Silas E. saloon, 134 Plymouth av.
 house do. [h. Seward c. Cady
 Stoecker Charles, market, 61 South Frances,
 Stoeffler Frederick, watchman, house rear
 17 Sanford [38 Saxton
 Stoepel Christian G. clerk, 262 State, house
 Stoeppler William, hairdresser, Congress
 Hall, boards 7 North avenue
 Stoertz Andrew, farmer, h. Harvest n. Bay
 Stoertz Andrew jr. turner, 3 Aqueduct, house
 Harvest near Bay
 Stoertz Henry, turner, bds. Harvest n. Bay
 Stoertz John, laborer, h. Third av. n. Bay
 Stoesser Bernard, laborer, house N. Clinton
 near Norton [Norton
 Stoesser Lucas, laborer, house N. Clinton n.
 Stoesser Walburga, widow, house N. Clinton
 near Norton
 Stoewsand Charles, machinist, b. 54 Hoeltzer
 Stoewsand William, turner, h. 54 Hoeltzer
 Stoffel John, shoemaker, 1 Mill, house 310
 North Clinton
 Stoffel Elizabeth, widow, h. 310 N. Clinton
 Stokes George W. foreman, 75 N. Water,
 house 50 Delevan
 Stokes Jabez, blacksmith, North avenue cor.
 Franklin, b. Farmers' Hotel
 Stokes James, janitor, house 52 Kent
 Stokes John, laborer, boards 167 State

Stokes John, sawmaker, 153 State, h. 18 Cliff
 Stokes John, laborer, house 1 North York
 Stokes P. blacksmith, bds. Farmers' Hotel
 Stoll Adam J. cabinetmaker, 184 State, h. 69
 Lowell [house do.
 Stoll August (Stoll Bros.), 34 St. Joseph,
 Stoll Bros. (A. and F. Stoll), bakers, 34 St.
 Joseph [69 Lowell
 Stoll Christian, tinsmith, 75 N. Clinton, bds.
 Stoll Frank (Stoll Bros.), 34 St. Joseph, b. do.
 Stoll Frederick, upholsterer, 184 State, bds.
 69 Lowell
 Stoll George, tailor, house 2 Edward
 Stoll George jr. tinsmith, 100 Hudson, bds.
 2 Edward
 Stoll Isabella, widow, boards 34 St. Joseph
 Stoll John A. cabinetmaker, 184 State, house
 69 Lowell [house 9 Rome
 Stoll Julius, cigar manuf. 123½ East Main,
 Stoll Lewis, carpenter, house 283 North av.
 Stoll Phillip, repairer, Erie Railway shop, h.
 45 Campbell
 Stoltz Frederick, butcher, b. 4 Plymouth av.
 Stoltz John, bartender, Exchange place cor.
 Mill, boards 16 Bartlett
 Stoltz Michael, shoemaker, 16 Bartlett, h. do.
 Stoltz Theodore, furcutter, 100 State, house
 48 Atkinson
 Stolz George, cabinetmaker, h. 24 Hawkins
 Stolz Margaret, widow, h. 65 Caledonia av.
 Stone Alonzo, cloth sponger, 10 W. Main, b.
 28 Munger [32 Atkinson
 Stone Archibald M. (J. S. Stone & Sons), b.
 Stone Benjamin W. rector Church of the
 Good Shepherd, house 16 Orange
 Stone Charles G. laborer, b. 13 Saratoga av.
 Stone Chas. J. boarding house, 134 S. St. Paul
 Stone Charles V. tinsmith, 122 State, bds. 28
 Munger
 Stone Clara A. widow, house 23 Andrews
 Stone Clarissa Miss, boards 20 Arnold park
 Stone Edward J. cutter, 124 Front, boards
 43 Lowell
 Stone Edward S. removed from city
 Stone Fred B. shoemaker, 15 Mill, boards
 York House
 Stone Frederick D. expressman, h. 15 Canal
 Stone George (Trotter & Stone), 29 Exchange
 house 87 Frank
 Stone George A. house 56 Asylum
 Stone Henry D. bookkeeper, Irving Mills,
 boards 21 Sophia
 Stone Henry W. (J. S. Stone & Sons), bds. 32
 Atkinson
 Stone Hezekiah B. house 7 Tappan
 Stone Howard P. clerk, h. 26 Fulton avenue
 Stone James, boards Farmers' Hotel
 Stone James, grinder, house 72 Jay
 Stone John, steward, 36 West Main, house 30
 Stillson [boards Trevor Hall
 Stone John F. student, Roch. Theol. Seminary,
 Stone John N. clerk, boards 56 Asylum
STONE JOHNS. & SONS (A. M. and H.
 N. W. Stone), merchants delivery, 106 W.
 Main, house 32 Atkinson.—*See page 604*
 Stone Joseph, b. 2 Reynolds [2 Reynolds
 Stone Joseph L. bookkeeper, Mt. Hope, bds.
 Stone Laura M. Miss, house 17 Greig

Stone Lyman L. (*Gibbons & Stone*), 86 State, house 7 Greig [3 Brown alley
 Stone Martin, gas fitter, Gas Works, house
 Stone Mary J. widow, house 43 Lowell
 Stone Mortimer F. machinist, house 170 N. St. Paul
 Stone Nathan C. removed from city
 Stone Nellie Mrs. boards 72 West avenue
 Stone Nettie C. teacher, Concord School, No. 18
 Stone Newell A. (*Wm. Burke & Co.*), 12 West Main, house 2 Reynolds
 Stone Othniel, boards 56 Asylum
 Stone Robert, sawmaker, boards 43 Lowell
 Stone Sarah J. Mrs. boarding house, 6 Platt, house do. [h. 65 Jay
 Stone Stephen, miller, Flour City Mills,
 Stone Thomas, deceased Nov. 15, 1875
 Stone Vincent, foreman, 136 Mill, house 28 Munger [Sophia
 Stone William, clerk, 76 State, boards 21
 Stone William, foreman, house 44 Martin
 Stone William, horse dealer, bds. 17 James
 Stoner Elizabeth L. boards East avenue cor. Alexander
 Stoneville Joseph, removed to Greece
 Stonger Margaret Mrs. boards 206 State
 Stoothoff Julia G. widow, h. 86 Alexander
 Stoppelbein Jacob, shoemaker, 190 State, h. 22 Kent [Main, house do.
 Stopperan Henry (*W. Monk & Co.*), 239 East
 Stops Daniel, driver, house 138 Plymouth av.
 Storaendt August, laborer, h. 12 Wadsworth
 Storaendt Frederick W. cabinetmaker, house St. Joseph near Hoeltzer
 Storaendt Henry, cabinetmaker, h. 7 Oakman
 Storaendt Mary B. widow, house Langham near St. Joseph
 Storaendt Wm. cabinetmaker, h. 26 Nassau
 Storck Philip A. gardener, house 61 Gregory
 Storer Charles, clerk, 3 Elwood block, bds. 146½ West Main
 Stork Michael, cistern maker, 307 Brown, house do. [Nassau
 Storm William, cabinetmaker, 184 State, h. 26
 Stormont Charles, machinist, bds. 33 Ward
 Stormont Hattie, dressmaker, bds. 33 Ward
 Stormont Mary, widow, house 33 Ward
 Stormont Peter, fireman, boards 33 Ward
 Storms Catharine, boards 45 Lake avenue
 Storms Frank, peddler, 144 E. Main
STORMS GEORGE N. merchant tailor, 10 West Main, h. 59 Andrews.—*See page 537*
 Storms George W. bookkeeper, 10 W. Main, boards 59 Andrews
 Storms Hiram, boiler maker, Platt, h. Costar near Thompson
 Storms Nancy, widow, boards 59 Andrews
 Storms William B. salesman, 10 West Main, house 1 Franklin square
 Storrs Eugene, dentist, house 6 Asylum
 Storrs Louisa P. widow, house 20 Arnold pk.
 Stortz George, butcher, house 12 South Ford
 Stortz George jr. butcher, b. 12 South Ford
 Stortz John, mason, 54 Fitzhugh
 Story George, rem'd to Grand Rapids, Mich.
 Story Mary A. widow, house 58 North av.
 Stosser Bernard, laborer, 30 West avenue, h. N. Clinton near Norton

Stott Bros. (*C. T. and S. W. Stott*), file manufs. 111 Mill [cord av.
 Stott Charles T. (*Stott Bros.*), house 22 Con-
 Stott George F. file manuf. River n. North Water, house 195 N. St. Paul
 Stott John S. policeman, N. Y. C. R. R. depot, house 61 Allen [St. Paul
 Stott Stephen W. (*Stott Bros.*), house 206 N.
 Stotts Julia, dressmaker, house 29 Franklin
 Stout Catharine, widow, h. 20 Railroad alley
 Stout George, deceased August 8, 1875
 Stout Helen, widow, boards 112 Bartlett
 Stout John, laborer, h. Hunter c. Genesee
 Stout Thomas, laborer, house 7 Seward
 Stout William, student, b. 51 Plymouth av.
 Stoutenberg Antoinette Mrs. h. 35 North av.
STOWELL CALVIN L. manager British American Assurance Co. 132 Powers' bldgs. boards 40 East av.—*See page 504*
 Stowell Charles F. clerk, 132 Powers' bldgs. boards 15 Atkinson
 Stowell Frank B. mason, h. 106 Fulton av.
 Stowell Harriet N. widow, house 20 Orange
 Stowell Jay D. hostler, 281 State, house 20 Lake avenue
 Stowell Omar G. mason, b. 106 Fulton av.
 Stowell Thomas P. gen'l. agent Etna Ins. Co. house 15 Atkinson [house do.
 Stowers Eugenia, dressmaker, 46 Atkinson,
 St. Patrick's Orphan Girls' Asylum, Frank near Platt [h. 29 Ward
 St. Peter Eliza, cutter, 141 North Water,
 Strachan Alexander, student, boards 24 Manhattan
 Strachan Charles, removed to New York city
 Strachan David (*Olmsted & Strachan*), 95 E. Main, boards 24 Manhattan
 Strachan James, house 24 Manhattan
 Strachan James jr. salesman, 73 East Main, boards 24 Manhattan
 Strachan William, salesman, b. 24 Manhattan
 Straghan Isabella, laundress, 12 N. St. Paul, boards Osburn House
 Straghan Rachel, laundress, 12 N. St. Paul, boards Osburn House
 Strain Murtagh J. removed to Ireland
 Strangman John, hatter, 2 Mumford, boards Reed House
 Strasburger Samuel, rem'd. to Baltimore, Md.
 Strassner Henry, market, 38 Orange, h. do.
 Strassner Jacob, jr. salesman, 53 E. Main, h. Campbell near Childs
 Straszner Jacob, dry goods, 238 Brown, h. do.
STRATTON GEO. L. & CO. (*T. C. White*), paper warehouse, 61 State, house 80 Plymouth avenue.—*See page 529*
 Stratton Robert M. pastor First M. E. church, h. 26 Fitzhugh [h. 130 Fitzhugh
 Stratton Sumner W. bookkeeper, 61 State,
 Straub John, grocer, 126 Lake avenue, h. Rowe cor. Straub alley
 Straub John B. laborer, house 13 Grape
 Straub Philip, laborer, h. 110 South avenue
 Strauch Adam, laborer, house 98 Chatham
 Strauch Henry, cabinetmaker, 155 N. Water, boards 121 Chatham
 Strauch John K. harness maker, 65 State, b. 98 Chatham

Strauchen Edward, mason, boards North av. cor. Channing
 Strauchen Elizabeth, widow, bds. 83 Cady
 Strauchen Ferdinand, mason, house First avenue near Bay [cor. Channing
 Strauchen John, mason, house North avenue
 Strauchen John R. mason, h. Bay n. North avenue [65 Chestnut
 Straus Abraham, bookkeeper, 44 Mill, bds.
 Straus Caroline, widow, house 65 Chestnut
 Straus Daniel (*Allen, Straus & Co.*), 26 West Main, house 36 Stillson
 Straus Godfrey L. pelts, boards 7 Leopold
 Straus Joseph jr. chairmaker, ft. Rowe, bds. Champion cor. Leavenworth alley
 Straus Marcus, salesman, 73 E. Main, boards 53 Chatham
 Straus Samuel, bookkeeper, bds. 65 Chestnut
 Straus Solomon (*Allen, Straus & Co.*), 26 W. Main, boards 65 Chestnut
 Straus Andrew, machinist, house 7½ Kirk
 Strauss David, agent, house 28 Nassau
 Strauss, see Strauss
 Streb Frank, 37 Andrews, house North av. opposite Clifford [North avenue
 Streb George, laborer, house Stewart near
 Streb Jacob, laborer, house 3 Hoeltzer
 Streb John, shoemaker, 20 Catharine, boards Stewart near North avenue
 Streb John, painter, boards 3 Hoeltzer
 Streb John, h. North avenue near Jennings
 Streb Joseph, clerk, 297 State, h. Clifford opposite North
 Streb Joseph, machinist, 12 S. Water, bds. North avenue opposite Clifford
 Streb Leonard, machinist, 138 Mill, b. North avenue opposite Clifford [Norton
 Streb Matthias, varnisher, h. St. Joseph near
 Streb Richard, foreman, West av. cor. Trowbridge, h. North av. near Jennings
 Streb Stephen, painter, house 10 Rauber
 Streb Victor, laborer, house North av. near Jennings [North cor. Clifford
 Streb William, shoemaker, 44 Exchange, h.
 Strebing Frederick, teamster, h. 121 N. St. Paul [house do.
 Strebler Michael, saloon, 22 Exchange place,
 Streck Nicholas, shoemaker, 63 Jay, house 84 Orange
 Strecker Frederick, boards 53 St. Joseph
 Street Chas. H. laborer, boards 12 Cliff
 Street Franklin, carpenter, boards 12 Cliff
 Street Libbie D. boards 12 Cliff
 Street Susan, widow, house 12 Cliff
 Streeter Alexander, boards 103 Allen
 Streeter Cordelia, boards 64 Jones
 Streeter Edward H. teamster, 33 West av. h. 61 Prospect [near rapids
 Streeter George W. 2d, boatman, h. Genesee
 Streeter George W. locktender, Valley canal rear 288 Plymouth avenue, boards do.
 Streeter Henry G. machinist, Court c. Stone, boards 224½ E. Main [224½ E. Main
 Streeter James, lockmaker, Court c. Stone, b.
 Streeter Lucy A. widow, boards 61 Prospect
 Streeter Lydia C. widow, boards 64 Jones
 Streeter Mary, teacher, Wadsworth school, No. 12, boards 101 Alexander

Streeter Mary E. widow, h. r. 288 Plymouth avenue
 Streeter Olney, machinist, Brown cor. Jones, house 103 Allen
 Streeter William, supt. Sargeant & Greenleaf's, Court cor. Stone, house 11 Scio
 Streeter William H. corkmaker, 205 Plymouth av. b. r. 288 Plymouth avenue
 Streeter Wm. M. removed to Buffalo
 Strehle Johan, shoemaker, 1 Henry, h. do.
 Strehle John M. shoemaker, 20 Catharine, house do.
 Strehle Leonard, shoemaker, 1 Henry, b. do.
 Streif Geo. teamster, Oak c. Smith, bds. 47 Childs n. Jay [smith's, 8 Plymouth av.
 Streiff Bros. (*J. M. and J. P. Streiff*), black-
 Streiff John M. (*Streiff Bros.*), h. 51 Front
 Streiff John P. (*Streiff Bros.*), h. 51 Front
 Streiff Michael, house 2 S. Washington
 Streiff Michael jr. shoemaker, bds. 2 South Washington
 Streitle Joseph, carpenter, h. Bloomingdale avenue near N. Clinton
 Stretch Michael, laborer, bds. 54 West av.
 Strick Joseph, bootmaker, 92 State, house 7 Childs [159 Lake av.
 Strickland Aaron P. sawyer, lower falls, bds.
 Strickland Susan L. dressmaker, b. 12 Frank
 Striebich Joseph, blacksmith, 188 State, h. Flower n. N. Clinton [S. Washington
 Striff Jacob, baker, 45 Fitzhugh, house 37
 Strigl Michael, shoemaker, house 54 Vienna
 Strigl Paul, tailor, 8 West Main, boards 54 Vienna [2 Briggs' place
 Striker Lorenzo (*Striker & Harrison*), house
 Striker & Harrison (*L. Striker and G. N. Harrison*), blacksmiths, 183 West av.
 Stringham John P. propr. Sprague Hotel, 100 Mill [bds. 89 Frances
 Stritt Gustave, watches, &c. 126 W. Main,
 Stritzel Charles, tailor, 23 Pryor, boards do.
 Stritzel Frederick, tailor, 16 West Main, h. 178 N. Clinton [avenue
 Stritzel Herman, carpenter, b. 25 McDonald
 Stritzel John, painter, house 61 Herman
 Stritzel Michael, boards Langham near St. Joseph [Edward
 Stritzel William F. woodworker, house 28
 Strobel Gottlieb, clerk, 17 State, house 127 Adams [Jay
 Strobel John, tailor, 2 West Main, house 239
 Strobel Joseph, cigarmaker, house 50 Ontario
 Strobel Louis, director St. Joseph's School, house 18 Franklin
 Strobel Martin, bootfitter, house 118 Orange
 Strobel Pauline Mrs. saloon, 50 Ontario, h. do.
 Stroblhagel Frederick, laborer, h. 70 Munger
 Stroh Catharine, market, Herman c. Thomas, house 42 Herman
 Stroh John F. deceased Oct. 1, 1875
 Strohm William, carpetweaver, 9 Elizabeth place, house do. [31 Savannah
 Strong Albert, wheelmaker, 3 Elizabeth, h.
 Strong Alvah, house 44 Lancaster
 Strong Augustus H. president Roch. Theological Seminary, h. 33 S. Clinton
 Strong Chas. clerk, 7 South St. Paul, house Sibley's block

- Strong Clarence B. carrier, Post Office, house
24 Concord av.
- Strong D. Mrs. widow, boards 7 Prince
- Strong Elma, widow, house 58 Griffith
- Strong Fanny, widow, bds. 4 St. Joseph
- Strong George R. machinist, Brown c. Jones,
house 17 N. St. Paul [61 Lake av.
- Strong Henry A. (*Strong & Woodbury*), house
- Strong Maltby, physician, house 10 South
Washington
- Strong Walter, steward, Protective Hose
House, Mill c. Market, house, do.
- Strong Wellington, peddler, 144 East Main
- STRONG & WOODBURY** (*H. A. Strong
and E. F. Woodbury*), whip manufs.
Allen c. N. Washington.—*See page 669*
- Stroup John, house Hudson near Berlin
- Stroup John W. gardener, bds. Hudson near
Berlin [house 2 St. Joseph
- Strouss Elias (*Cauffman & Strouss*), 46 Mill,
Strouss, see Straus
- Strow Peter, laborer, b. North av. n. Norton
- Strowbridge Lucy, widow, boards Scottsville
road at Rapids [avenue
- Strowger Jane, widow, b. Stewart n. North
- Strowger Orville H. removed to Penfield
- Strowger Samuel W. surveyor, bds. Stewart
near North avenue [North av.
- Strowger Wm. D. farmer, h. Stewart near
Stroyer Cornelia, widow, boards 18 Helena
- Stroyer Leonard J. (*Stroyer & Christiaansen*),
63 Asylum, house 18 Helena
- Stroyer & Christiaansen (*L. J. Stroyer and
I. Christiaansen*), carpenters, 63 Asylum
- Strubb Henry, laborer, house 96 Meigs
- Struble Charles W. driver, house 67 Troup
- Struby Louis H. clerk, 34 W. Main, bds. 35
Frank
- Struck Charles, grocer, 69 St. Joseph, h. do.
- Struck Frederick, shoemaker, house 9 Maria
- Struck Geo. clerk, 69 St. Joseph, bds. do.
- Strutz Theodore, laborer, h. 158 Lewis near
Meigs [Lewis
- Strutz William, butcher, house Meigs near
- Stuart Henry B. salesman, 13 E. Main, bds.
33 Meigs
- Stuart Hugh E. carpenter, West end Court
street bridge, bds. 58 S. Union
- Stuart Jamine H. dry goods, 13 East Main,
house 33 Meigs
- Stuart Jane A. widow, house 58 S. Union
- Stuart John A. carpenter, bds. 58 S. Union
- Stuart Mary, domestic, boards 40 N. Water
- Stubbs Samuel, patternmaker, Brown's race
near Furnace, house 10 Platt
- Stuchfield Alfred, tinsmith, 97 East av. h.
235 Exchange [change
- Stuchfield Elizabeth, widow, boards 237 Ex-
- Studley Luther, house 38 Alexander
- Stuehler Adam, carver, boards 69 Herman
- Stuehler Christopher, W. carpehter, house
Thomas near Bernard
- Stuehler Henry, laborer, house 69 Herman
- Stuehler Henry jr. laborer, house Thomas
near Clifford
- Stuermer Caspar, stonecutter, house Maria
- Stuermer George, trunkmaker, Aqueduct, b.
Bay c. First av.
- Stuermer John, grocer, Bay corner First
avenue, h. do.
- Stueve John, laborer, house 54 Hoeltzer
- Stueve William, laborer, house Hoelfer near
North Clinton [Monroe avenue
- Stühler John, butcher, 30 Front, house 212
- Stuld't Henry, removed from city [Hugh
- Stull Jos. A. lawyer, 52 Arcade, h. 142 Fitz-
- Stull Mary, domestic, boards 8 East
- Stump Chester H. & Co. (*H. E. Stump*),
printers, 67 Arcade, h. 31 North avenue
- Stump Horace E. (*C. H. Stump & Co.*), 67
Arcade, house at Chicago, Ill.
- Stumpf Anthony, laborer, h. North av. n. Bay
- Stumpf Louis H. carpenter, b. 98 North av.
- Stumps Anthony Mrs. nurse, h. 128 North
avenue [boards 128 do.
- Stumps Joseph, hairdresser, 114 North av.
- Stunz Martin, mason, house Bay n. Goodman
- Stunz Martin jr. mason, b. Bay n. Goodman
- Stupp Charles, salesman, 53 East Main, h.
42 St. Joseph [200 Alexander
- Stupp Jacob, salesman, 53 East Main, house
- Stupp Michael, salesman, 53 East Main, h.
28 Gorham
- Sturges David, contractor, h. 27 Phelps av.
- Sturges Joseph D. bookkeeper, boards 27
Phelps avenue
- Sturla Johanna, widow, h. r. 47 N. St. Paul
- Sturm Christopher, frame maker, 24 Ex-
change, house 10 Catharine
- Sturm John, teamster, house 17 Thomas
- Stutus James H. prop. Park Hotel, Roches-
ter Drivinfg Park, house do.
- Stutte Adolph, printer, 18 N. St. Paul, b. do.
- Stutterheim Wilhamena, widow, boards 6
North avenue
- Stutz August, carpenter, house 42 N. Frances
- Stutzrehm John, laborer, house 18 Rhine
- Stuvenhaver Elizabeth, widow, bds. 8 Allen
- Stuvenhaver Jacob, saloon, 8 Allen, h. do.
- Stuvenhaver Nicholas, painter, bds. 8 Allen
- Stuver Byron, M. blacksmith, r. 145 E. Main,
house Clifford near Hudson
- Styart Jenny, domestic, boards 202 E. Main
- Styles J. William, peddler, h. 7 Fullam's pk.
- Sucro Geo. C. bookkeeper, 139 N. St. Paul,
house 9 Oakman
- Sudheimer Frederick, cabinet maker, 2 Hill,
house 186 N. Clinton [3 Miller
- Suess Emanuel F. tinsmith, 74 North av. h.
- Sugru Charles C. superintendent, boards 13
Stone
- Sugru Daniel, removed to Rauchville, Pa.
- Sugru Edward J. (*Jones & Sugru*), 43 State,
house 17 S. Clinton
- Sugru John F. waiter, house 84 Caledonia av.
- Sugru Julia, widow, house 13 Stone
- Sugru J. Thomas, waiter, house 75 West av.
- Sulzr Charles, teamster, h. Henrietta av. n.
Allmeroth
- Sulzr Charles, clothier, 105 Hudson, house do.
- Sulzr Elizabeth, widow, bds. Henrietta av. n.
Allmeroth
- Suhr Frederica, widow, boards 105 Hudson
- Suiler Cirill (*Mayer & Suiler*), Cottage near
Plymouth avenue, house do.
- Sullivan Amelia, removed to Brooklyn, L. I.

Sullivan Andrew, laborer, b. 181 St. Joseph
 Sullivan Andrew, laborer, h. Flint n. Genesee
 Sullivan Andrew jr. machinist, b. 10 Flint n. Genesee
 Sullivan Andrew P. clerk, 36 State, bds. 64 Adams
 Sullivan Ann Mrs. house Frank c. Brown
 Sullivan Anna, clerk, boards 6 Emmett
 Sullivan Catharine, widow, h. Finney cor. Davis
 Sullivan Catharine Mrs. house 90 Atwater
 Sullivan Charles, cigar manuf. 53 Arcade, h. 25 Romeyn
 Sullivan Cornelius, boatman, house 41 South Washington
 Sullivan Cornelius P. laborer, b. 64 Adams
 Sullivan Daniel, mason, house Brighton near Pinnacle avenue
 Sullivan Daniel, tailor, boards 5 Marietta
 Sullivan Daniel C. house 4 Tremont place
 Sullivan Daniel E. currier, 129 State, house 5 Marietta [Adams
 Sullivan Daniel H. clerk, 64 State, boards 64
 Sullivan Dennis, laborer, house Seward near Strong [bds. 205 State
 Sullivan Dennis C. shoemaker, 83 N. Water, Sullivan Eliza, dressmaker, 92 Atwater, house do. [Marietta
 Sullivan Eliza G. hairdresser, boards 5
 Sullivan Ellen, widow, house 181 St. Joseph
 Sullivan Esther, widow, h. Penn near Saxe
 Sullivan Esther J. widow, house 23½ Romeyn
 Sullivan Eugene, saloon, University av. near R. R. house do.
 Sullivan Eugene, laborer, house 114 Adams
 Sullivan Florence, laborer, Brown c. Jones, house 30 Jones [h. 34 Platt
 Sullivan Florence, cigar maker, 45 E. Main,
 Sullivan Frank G. saw maker, 153 State, bds. 39½ Romeyn
 Sullivan Henry J. (*Townsend & Sullivan*), 90 Powers' bldgs, boards 25 Romeyn
 Sullivan Henry L. machinist, 124 Mill, bds. 22 Wilder [key av. near av. B
 Sullivan Jas. trunk maker, ft. Rowe, h. Con-Sullivan James, blacksmith, Brown n. State, house 16 Brown's alley
 Sullivan James B. caller, N. Y. C. freight yard, house 178 St. Joseph
 Sullivan James P. clerk, 53 E. Main, boards 23½ Romeyn [Paul
 Sullivan Jeremiah, laborer, boards 31 S. St.
 Sullivan Jeremiah, laborer, boards 92 Front
 Sullivan Jeremiah, laborer, house 6 Emmett
 Sullivan Jeremiah, peddler, house 64 Adams
 Sullivan Jeremiah jr. blacksmith, 3 Canal, b. 64 Adams
 Sullivan Jeremiah P. fireman, N. Y. C. R. R. house 15 Fochner
 Sullivan John, laborer, boards 2 Centre
 Sullivan John, teamster, b. Penn near Saxe
 Sullivan John, blacksmith, 109 Pinnacle av. house Whalin n. Munger
 Sullivan John E. deceased, May, 1875
 Sullivan John H. hackman, 47 S. St. Paul, h. 226 W. Main
 Sullivan John H. shoemaker, b. 39½ Romeyn
 Sullivan John O. tailor, 123 Broadway, h. do.

Sullivan Josephine, dressmaker, b. 5 Marietta
 Sullivan Josiah, lawyer, 1 Court House, bds. Whitcomb House [bds. 11 do.
 Sullivan Josie, hairdresser, 2 Sibley's block,
 Sullivan Mary, copyist, boards 28 Scio
 Sullivan Mary, widow, house 22 Wilder
 Sullivan Mary, widow, boards 53 Frances
 Sullivan Mary, chambermaid, Osburn House
 Sullivan Mary J. clerk, 98 Mill, b. 6 Emmett
 Sullivan Michael, car inspector, b. 166 Scio
 Sullivan Michael, yardman, Waverley House, boards do.
 Sullivan Michael, laborer, house 63 Allen
 Sullivan Michael, shoemaker, h. 39½ Romeyn
 Sullivan Nora Miss, house 218 West Main
 Sullivan Patrick, hostler, Whitcomb House
 Sullivan Patrick, laborer, house 167 Scio
 Sullivan Patrick H. captain of police, City Hall, house S. Ford c. Waverley place
 Sullivan P. Andrew, clerk, boards 64 Adams
 Sullivan Richard, blacksmith, b. Whalin n. Munger
 Sullivan Sarah, seamstress, house 28 Scio
 Sullivan S. student, boards 16 Elm
 Sullivan Thomas, laborer, bds. 63 Wilder
 Sullivan Timothy, laborer, h. 161 St. Joseph
 Sullivan Wm. F. conductor, N. Y. C. R. R. house 88 Atwater
 Sullivan Wm. H. blacksmith, Brown n. State, bds. Brown's alley n. Brown
 Sullivan, see O'Sullivan [Fitzhugh
 Sully Darrel D. lawyer, 58 Arcade, bds. 40½
 Summerhays Joseph, draughtsman, 102 Powers' bldgs. bds. 56 Alexander
 Summerhays Wm. mason, h. 56 Alexander
 Summerhays William jr. mason, boards 56 Alexander
 Summers Albert, teamster, house 5 Griffith
 Summers Bridget, domestic, 89 Frank
 Summers Charles, student, boards 28 Pearl
 Summers James A. hostler, house 20 Stone
 Summers Mary, widow, house 81 Adams
 Summers Theodore A. (*Summers & Turpin*), house at Irondequoit
 Summers & Turpin (*T. A. Summers and T. H. Turpin*), mouldings, 43 N. Water
 Summer Charles, physician, 14 S. Clinton, h. do.
 Summer Charles R. student, 14 S. Clinton, boards do. [Clifford
 Sund Christian, laborer, house Thomas near Sunderlin Eli, house 20 Howell
 Sunderlin Lewis (*Sunderlin & McAllaster*), house 25 Sophia
SUNDERLIN & McALLASTER (*L. Sunderlin and G. McAllaster*), watches, jewelry and silverware, 18 State.—*See page 516*
 Sunfield Elizabeth, widow, b. 285 St. Joseph
 Sunfield Francis, deceased January, 1876
 Sunfield Peter, shoemaker, 75 N. Water, h. 285 St. Joseph [150 Exchange
 Sunney Patrick, porter, 12 West Main, house
 Sunney Thomas, stonecutter, b. 150 Exchange
 Suri John, house 51 Front
 Surr Thomas, edge tool maker, 136 Mill
 Surratt Joseph, stonecutter, 22 West avenue, house Saxe near Tremont
 Surratt Louisa, widow, b. Saxe n. Tremont
 Suss Adolph, hairdresser, b. Wilder c. Orchard

- Suss August, collarmaker, 98 E. Main, bds. 70 Wilder
 Suss Charles, cutter, 76 Mill, b. 29 Sellinger
 Suss Christian, saloon, Wilder cor. Orchard, house do.
 Suss Frederick, tailor, 29 Sellinger, house do.
 Sussein Johanna, widow, house 9 Baden
 Suter Casper, gardener, house 38 Caroline
 Suter Frederick, packer, 73 E. Main, house 18 Favor [65 Broadway
 Suter Frederick, carver, Jay cor. canal, house
 Suter Jacob, carpenter, 107 South St. Paul, house 17 Holland
 Suter Jacob C. machinist, house Rohr n. Bay
 Suter John, carpenter, 70 Hudson
 Suter Mary, widow, boards 142 N. Clinton
 Suter Rudolph, carpet weaver, h. Munger n. South avenue [near Sherman
 Sutherland James, shoemaker, h. Michigan
 Sutherland Smith R. tailor, 14 State, h. 26 South Ford [Rochester, b. 22 Sophia
 Sutherland Ward T. student, University of
 Sutter Benjamin, porter, 21 W. Main, house 17 Hamilton place
 Sutter Charles E. brewer, house 87 Cady
 Sutter John, laborer, house 53 Kirk
 Sutter Maria, widow, boards 17 Hamilton pl.
 Sutter Mauritz, boards 87 Cady
 Sutter Samuel, cabinetmaker, 184 State, h. 7 Philander
 Sutton Josephine, dressmaker, bds. 18 John
 Swager Ann, widow, house 35 Hudson
 Swager George, wagonmaker, 3 Canal, bds. 122 Chatham
 Swager Mary, widow, boards 111 Orange
 Swager Simon, deceased Jan. 14, 1876
 Swan Henry R. machinist, boards 2 Bolivar
 Swan Hiram C. removed from city
 Swan Matthew, clerk, 194 State, bds. Locust near Deep hollow [21 Wilder
 Swan Michael, blacksmith, 29 Mumford, bds.
 Swan Patrick, laborer, house Locust near Deep hollow [h. 145 West av.
 Swan Thomas, physician, 123 Powers' bldgs.
 Swan Wm. machinist, 116 Mill, h. 2 Bolivar
 Swan, see Schwan
 Swanton Elias, laborer, house 97 Atkinson
 Swanton Elias J. clerk, State cor. Centre, bds. 91 Atkinson
 Swanton James, laborer, h. 43 Concord av.
 Swanton John, cartman, house 69 Tremont
 Swanton John, driver, 67 Fitzhugh, b. 69 do.
 Swanton John W. carpenter, house 11 Davis
 Swanton Robert, clerk, Union nurseries, bds. 43 Concord avenue
 Swanton Robert laborer, house 44 Kirk
 Swanton Robert G. expressman, 35 Exchange, house 99 Atkinson
 Swanton Thomas, telegrapher, b. 91 Atkinson
 Swart Edwin W. photographer, boards 61 Monroe av. [61 Monroe avenue
 Swart Julia A. dressmaker, 55 East Main, h.
 Swarouth Alexander, agent, h. 9 William
 Swarouth Sarah J. Mrs. dressmaker, 9 William, house do.
 Swartz John, mason, house 8 Bay
 Swartzweller N. Clark, salesman, 21 North St. Paul
 Swatts Elizabeth, widow, house 115 Scio
 Swatts Joseph, tobacconist, 25 West Main, boards 115 Scio [bds. 192 Brown
 Sweatman Charles E. silver plater, 3 Canal,
 Sweatman George A. gilder, 43 N. Water, house Costar near Thompson
 Sweatman Mary, widow, house 192 Brown
 Sweatman Richard, cigar maker, 21 Front, house 17 Sellinger
 Sweazy J. C. peddler, 144 East Main
 Sweeney Daniel J. laborer, bds. 37 Frank
 Sweeney Dennis, laborer, house 47 Frost av.
 Sweeney Edward, laborer, h. Lyell c. R. R.
 Sweeney John, laborer, house 4 Allen's alley
 Sweeney Jane, widow, house 36 South av.
 Sweeney Mary, dressmaker, boards 30 Smith
 Sweeney Michael, gardener, boards 89 Front
 Sweeney Patrick H. salesman, 53 East Main, house 5 Amity
 Sweeney Timothy, laborer, house Mansion n. Flint [Furnace, h. 48 Weld
 Sweeney William, moulder, Brown's race n.
 Sweeney, see McSweeney
 Sweet Clarence H. clerk, house 26 East av.
 Sweet George M. cashier Bank of Rochester, 41 State, house 26 East avenue
 Sweeting Ambrose P. carriagemaker, 3 Canal, house 11 Schleyer's block
 Sweeting Bernard, sash manuf. 34 Joiner, house do. [84 State, bds. do.
 Sweeting Cornelius A. (*J. B. Sweeting & Bro.*),
SWEETING JOHN B. & BRO. (*C. A. Sweeting*), millinery and fancy goods, 84 State, house Lake View. — *See under Calendar*
 Sweeting William, sash maker, bds. 34 Joiner
 Sweetman Wm. H. removed to Palmer
 Sweitzer Charles D. cabinet maker, Jay cor. canal, boards 55 Lime
 Sweitzer Ella Miss, seamstress, 55 Lime, b. do.
 Sweitzer Francis J. cabinet maker, Jay cor. canal, house 55 Lime
 Sweitzer Jennie, seamstress, bds. 55 Lime
 Sweitzer John, cooper, Magne n. R. R. house Hague near West avenue
 Sweitzer Thomas, cabinetmaker, Jay cor. canal, house 33 Bolivar [30 Cole
 Swenzer Gottlieb, tanner, 51 North Water, h.
 Swetland George, rem'd to Milwaukee, Wis.
 Swetland Norris, confectioner, 33 E. Main, house do.
 Swetland Warren, rem'd to Milwaukee, Wis.
 Swetman Mary, widow, house foot Buell av.
 Swetman Samuel, carpenter, b. ft. Buell av.
 Swezey Anna, student, boards 14 Chatham
 Swick Charles L. printer, 3 West Main, h. 73 Lake avenue
 Swift A. J. agent, house 14 North Clinton
 Swift Celia Miss, sewer, River near North St. Paul, boards 43 South av.
 Swift Clarence C. clerk, bds. 146½ W. Main
 Swift George K. (*Swift & Williams*), house 9 Comfort
 Swift Hannah Mrs. house 113 Mill
 Swift Hattie, widow, house 144 Howell
 Swift John, cutter, 111 State, b. 45 Oakman
 Swift Lewis (*Swift & Gordinier*), hardware, 335 State, house 49 Ambrose

- Swift Rachel, widow, house 55 Goodman
 Swift Susanna, widow, boards 9 Comfort
 Swift Zenas M. lawyer and insurance, 101 Powers' bldgs. house 57 Alexander
- SWIFT & GORDINIER** (*L. Swift and E. D. Gordinier*), hardware, iron and steel, 335 State.—*See page 631*
- Swift & Williams (*G. K. Swift and G. W. Williams*), grocers, 57 South Clinton
- Swikehard George B. (*Swikehard & Hondorf*), house Lyell near canal [do.]
- Swikehard William H. clerk, 104 Lyell, bds.
 Swikehard & Hondorf (*G. B. Swikehard and W. Hondorf*), restaurant, 12 Exchange place
- Swinburn George, physician, 12 Jay, h. do.
 Swinburn George jr. clerk, 38 East Main, b. 12 Jay
- Swinburne James E. cigar packer, 48 Exchange, h. 5 Asylum
 Swinburne John W. (*Swinburne & Co.*), 90 Arcade, h. 5 Asylum
- Swinburne Robert, printer, boards 5 Asylum
 Swinburne & Co. (*J. W. Swinburne and C. H. Moody*), printers, 90 Arcade
- Swinerton John M. real estate, h. 32 George
 Sykes Charles S. machinist, b. 243 Exchange
 Sykes James, house 243 Exchange
 Sylvester Augustus, shoemaker, 7 South St. Paul, house 242 North Clinton [av.]
- Sylvester Joseph, chiselmaker, b. 89 North
 Syme Charles M. toolgrinder, h. 45 Sellinger
 Syme Margaret, widow, bds. 96 N. Water
 Syme Margaret E. Miss, b. 108 University av.
 Symonds Andrew J. blacksmith, North av. cor. Franklin, house 36 North av.
- TABER SILAS W.** foreman, 136 Mill, house 38 Warner
- Tabor Edgar F. removed to Irondequoit
 Tabor Frank A. clerk, 57 West Main, boards 18 Sophia
- Tabor Olive, widow, boards 57 Atkinson
 Tack Francis, laborer, house 21 Sherman
 Tack Frank, sashmaker, 7 West Main, bds. 21 Sherman [28 Sherman]
- Tack Isaac, carpenter, Brown's alley, house
 Tack Jacob, carpenter, house 29 Sherman
 Tack Jacob jr. doormaker, Aqueduct, bds. 23 Sherman [Baden]
- Tack Jacob, 2d, polisher, 87 Exchange, h. 68
 Tafe James, laborer, house 161 Scio
 Tafe Kate, seamstress, boards 161 Scio
 Taft Albert S. (*Taft Bros.*), house 2 Oak
- TAFT BROS.** (*A. S. and G. T. Taft*), druggists and physicians, 146 West Main.—*See page 570*
- Taft Gilbert T. (*Taft Bros.*), house 8 Oak
 Taft Margaret A. (*Taft & Ferguson*), h. 2 Oak
 Taft & Ferguson (*M. A. Taft and A. J. Ferguson*), millinery, 58 State
- Taggard Paul, shoemaker, boards 9 Otsego
 Tahaney John, switchman, N. Y. C. R. R. yard, boards 115 North Clinton
 Tahaney Patrick, switchman, N. Y. C. R. R. yard, boards 115 North Clinton
 Tahany Owen, house 39 Bolivar
 Taillie Elizabeth, widow, house 80 Kelly
- Taillie Henry J. (*Shorer & Taillie*), 145 North Water, house 37 Thomas
- Tait Catharine, widow, house 18 Spencer
 Tait Thomas, foreman, at Ezra Jones & Son's, house 9 Marietta
- Tait, see Tate [bds. 10 Magne]
- Talbot Alfred H. printer, 9 Elwood block,
 Talbot Almira, deceased March, 1876
 Talbot Celia, widow, house 10 Magne
 Talbot Earl A. market, 34 Kent, h. 93 Jay
 Talbot Henry, maltster, 218 Alexander, house Lewis near Union
- Talbot Rial W. house 56 Grape [Hunter]
 Talbot Richard, gardener, h. Summer near
 Talbot William, clerk, 146 Brown, boards 10 Magne
- Talling Esther E. widow, house 1 Adams
 Talling Francis, trimmer, 157 W. Main, bds. 1 Adams [1 Adams]
- Talling John, laborer, Erie freight house, b.
 Talling Maggie A. clerk, 7 E. Main, boards 1 Adams [pect]
- Tallinger Frederick, blacksmith, h. 22 Pro-
 Tallinger George, gardener, h. 4 Lawrence
 Tallinger Godfrey F. carriagemaker, 3 Canal, house 22 Prospect
- Tallinger Gottfried, house 125 Alexander
 Tallinger John G. carpenter, h. 4 Lawrence
 Tallinger Louis W. agent, house 23 William
 Tallinger Mary A. deceased September, 1875
 Tallmudge Permilia L. widow, h. 46 Lake av.
 Tallmage Bradford A. machinist, Court cor. Stone, boards 6 Adams [6 Adams]
- Tallmage Joseph A. clothier, 11½ Spring, h.
 Tallmage Samuel H. removed to Victor
 Talman John, soap manufacturer, 168 South St. Paul, house 37 Marshall
- Talty Julia, saloon, 92 Front, house do.
 Tamblingson Nicholas, house 7 Prince
 Tamblingson Thomas, bookkeeper, 124 Mill, house 161 Jones [Romeyn]
- Tamblyn Frank, miller, 1 W. Main, h. 13
 Tanck Frederick W. cabinetmaker, 2 Hill, h. Bethlehem pk.
- Tangneuy Robt. R. fishing tackle, 11 Smith's block, h. do.
- Tanner Albert, shoemaker, house 64 Orange
 Tanner Almon E. foreman, house 45 Sanford
 Tanner Catharine, widow, house 81 Atkinson
 Tanner Charles, turner, house 16 Seward
 Tanner Edward, laborer, house 143 Hunter
 Tanner Edward, hackman, h. 83 Atkinson
 Tanner Edward jr. machinist, 107 N. Water, boards 11 Fitzgugh
- Tanner Isabella, stitcher, house 8 East Maple
 Tanner John, deceased, April, 1876
 Tanner Myron D. teamster, h. 139 Hunter
 Tanner Paul, laborer, boards 16 Seward
 Tanner Richard, carpenter, b. 81 Atkinson
 Tanner Richard H. carpenter, b. 143 Hunter
 Tanner Theodore, wiper, boards 8 E. Maple
- TANNER WILLIAM**, carpenter and contractor, r. 196 W. Main, h. 56 Atkinson.—*See page 634*
- Taplin Benjamin, quarryman, h. 123 Cady
 Tarcott Paul V. shoemaker, 79 N. Water
 Targee Alanson, peddler, 144 East Main
 Targee Sarah M. widow, h. 75 Monroe av.

A. R. PRITCHARD & LIKLY,

GLOVES, CANES, ETC., A LARGE STOCK,
No. 78 STATE STREET.

Tarrant Harry A. watchman, h. 5 Waverley place [10 Genesee
 Tarrant James L. foreman, 111 State, house
 Tazarkiewicz Joseph, harnessmaker, 3 Canal, house 28 Nassau
 Tate George W. carpenter, b. 143 North av.
 Tate, see Tait [1 Hanover
 Tauber Adam, ash buyer, 168 S. St. Paul, h.
 Tauber Catharine, midwife, house 1 Hanover
 Taunton Arthur F. carriagemaker, 3 Canal, h. 42 Saratoga av. [Phelps av.
 Taunton John W. cutter, 25 Mill, house 25
 Taunton William R. cabinetmaker, Jay cor. canal, house 18 Fulton house
 Taylor Andrew, teacher, house 71 William
 Taylor Anna, widow, house 5 Anson park
 Taylor Augusta C. boards 7 Marshall
 Taylor Baker, coachmaker, 3 Canal, boards 9 Prospect
TAYLOR BROTHERS (*G. and F. Taylor*), thermometer manufacturers, 3 Hill. —See page 669
 Taylor Charles, peddler, house 124 Broadway
 Taylor Charles, teamster, Vacuum Oil Works, boards 4 Edinburgh [38 Ambrose
 Taylor Chas. M. clerk, Kent cor. Platt, bds.
 Taylor Clarence W. actor, bds. 32 Comfort
 Taylor Clarissa A. widow, house 20 Marshall
 Taylor Cornelia, widow, h. 2 N. Washington
 Taylor Daniel B. photographs, 155 W. Main, boards 179½ do.
 Taylor Donald, house 16 Vine
 Taylor Donald jr. boards 16 Vine
 Taylor Edward W. painter, 3 Canal, bds. 9 South Ford
 Taylor Electus B. L. student, University of Rochester, boards 255 North St. Paul
 Taylor Elizabeth A. Miss, matron, House of Refuge, boards do.
 Taylor Esau M. removed to Buffalo
 Taylor Ezra (*Taylor & Co.*), 205 Plymouth avenue, house do.
 Taylor E. boards Farmer's Hotel [line
 Taylor Fannie M. Mrs. dressmaker, h. 7 Carro
 Taylor Francis L. physician, h. 96 West av.
 Taylor Frank (*Taylor Bros.*), h. 4 Clifton
 Taylor Frederick, carpenter, 21 Minerva al.
 Taylor Fred A. student, University of Roch. boards 12 Clifton
 Taylor George T. painter, house 9 Mathews
 Taylor George (*Taylor Bros.*) h. 12 Clifton
 Taylor George H. carpenter, h. Culver road near Monroe avenue [Lyell
 Taylor Geo. W. (*Martin & Taylor*), house 7
 Taylor Harrison H. machinist, b. 28 Clifford
 Taylor Henry H. driver, 5 Aqueduct, house 15 Kent [Railroad avenue
 Taylor Jane, widow, h. North York near
 Taylor Jay, conductor, N. Y. C. R. R. bds. Brackett House
 Taylor John & Sons (*T. B. and J. W. Taylor*), hats, 13 Front, h. 46 Caledonia av.
 Taylor John, carpenter, h. 47 Mt. Hope av.
 Taylor John, house 18 Philander
 Taylor John, laborer, house 1 Hebard
 Taylor John, carpenter, b. 141 West Maple
 Taylor John A. (*H. B. Cleveland & Co.*), 119 West Main, house 10 Foehner

Taylor John H. trunkmaker, h. 26 Gates av.
 Taylor John L. carriage trimmer, 3 Canal, house 7 Marshall
 Taylor John N. removed from city
 Taylor John W. (*J. Taylor & Sons*), b. 46 Caledonia avenue
TAYLOR JOHN W. photographer, colors, 83 East Main, b. Whitcomb House.—See page 542
 Taylor Jonathan C. agent, 85 Front, h. 13 North Goodman [mouth av. b. do.
 Taylor Louis H. (*Taylor & Co.*), 205 Plymouth
 Taylor Maria, stitcher, boards 6 Platt
 Taylor Mary B. widow, house 84 Atwater
 Taylor Mary C. milliner, house 9 Swan
 Taylor M. Elizabeth, artist, b. 46 Caledonia avenue
 Taylor Nancy A. widow, b. 271 N. St. Paul
 Taylor Porter W. carpenter, Court near Exchange, house Marshall c. Broadway
 Taylor Samuel H. agent, 17 Masonic blk. b. 11 Fitzhugh
 Taylor Thos. A. student, University of Roch. boards 5 Stillson
 Taylor Thomas B. (*J. Taylor & Sons*), b. 46 Caledonia avenue
 Taylor William, insurance agent, 22 Exchange, house 339 N. Clinton
 Taylor William, lather, boards 1 Hebard
 Taylor William H. salesman, 17 State, house 87 Alexander
 Taylor William H. shoecutter, Andrews cor. N. Water, boards Chapman House
 Taylor William H. painter, h. 268 N. Clinton
 Taylor William S. clerk, 9 Walbridge's blk. boards 38 Ambrose
TAYLOR & CO. (*E. and L. H. Taylor*), props. Flower City Cork Mills, 205 Plymouth avenue.—See page 668
 Teal Albert S. removed from city
 Teal Squire (*J. Greenwood & Co.*), 124 Mill, house 19 Phelps avenue
 Teal William, machinist, 126 Mill, h. 17 Oak
TEALL ABRAHAM, market, 79 Caledonia avenue, h. 75 do.—See page 555
 Teall Augustus, printer, 3 W. Main, boards 4 Averell
TEALL ISAAC, caterer and restaurateur, 38 Fitzhugh, house 158 do.—See page 560
 Teall Jacob, clerk, 37 State, h. 145 Hunter
 Teall James S. tinsmith, 65 Exchange, house 2 Leopold
 Teall Louisa, boards 39 North York
 Teall Philip, butcher, 79 Caledonia avenue, h. Caledonia av. c. Glasgow
 Tear Catharine, widow, house 25 W. Troup
 Teare Isaac, carpenter, house 18 East
 Teare James, telegrapher, boards 18 East
 Teare John, carpenter, boards 16 Joiner
 Tebbs John, laborer, house rear 49 Tyler
 Tebor Frank, clerk, boards 18 Sophia
 Tecla Sister, teacher, boards Jay c. Frank
 Tefft Mary D. widow, house 45 Clinton pl.
 Tegg Albert, veterinarian, 309 State, h. do.
 Tegg Harriet, widow, house 5 Smith [b. do.
 Tegg John J. veterinary surgeon, 5 Smith,
 Tegg William, boards 5 Smith
 Tehean Daniel, boards 77 Clifton

- Tehean Jeremiah, tinsmith, 48 Exchange, house 77 Clifton
- Teis John, carpenter, house 106 North av.
- Teit Isabella, nurse, boards 27 Scio
- Telfer Sarah H. widow, boards 13 Sophia
- Telford George, patternmaker, 100 S. St. Paul, house 5 Jones
- Telintum Martin, painter, h. 126 North av.
- TeLintum Mary E. Mrs. house 60 St. Joseph
- Teller Catharine, deceased Sept. 1875
- Teller Frederick T. bridgebuilder, house 100 North avenue [52 Hickory
- Teller George C. photographer, 81 E. Main, h.
- Teller John, tree agent, house 11 Scrantom
- Teller John B. bartender, 7 Mumford, house 2 George [258 St. Joseph
- Temp Louis, shoemaker, 87 North Water, h.
- Templeton James J. stonecutter, 22 West av. house 31 Canal
- Teneyck Mary Mrs. house 27 Prince
- Tepper Charlotte, widow, boards 20 Hanover
- Tepper John, laborer, house 155 N. Clinton
- Tepper John, laborer, house 17 Holland
- Tepper John, laborer, house 22 Henry
- Terberg Albert, carpenter, house Goodman near Park avenue
- Teresa Joseph Sister, teacher, b. Jay c. Frank
- Ter Haar John, carpenter, h. 289 St. Joseph
- Terrel Edwin, bookkeeper, 45 Andrews, bds. 44 N. Clinton
- Terry Ellen, widow, house 35 S. Washington
- Terry James, prop'r Congress Hall, h. do.
- Terry Louis L. removed to Chicago, Ill.
- Terry Sarah, tailoress, bds. 17 Gardiner pk.
- Terry Seth H. lawyer, 81 Powers' buildings, house 2 Tremont [State, h. 52 Jones
- Terry Thomas F. carpenter, Railroad av. n.
- Terry William H. printer, 23 W. Main, house 79 Frances
- Terson Isaac, laborer, h. Norton n. Carter
- Tesch Alvina, widow, boards 6 Nassau
- Tesch John A. deceased Oct. 1875
- Tessen Joseph, house 14 Helena
- Tessey George L. machinist, foot Furnace, boards 161 North Clinton [av.
- Tesson Christian, laborer, h. Klink n. Monroe
- Teubert George, laborer, house St. Joseph near Hayward park
- Teubert John, baggageman, N. Y. C. R. R. depot, house 145 North Clinton
- Teufel Mary, widow, house 3 Tappan
- Teutsch Lawrence, laborer, h. 6 Elizabeth pl.
- Teutsch Michael, tailor, 29 Sellinger, boards 6 Elizabeth place [68 N. Clinton
- Thalheimer Ignatz, 72½ Powers' bldgs. house
- Thalheimer Jacob, clerk, 11 State, bds. 68 North Clinton [b. 60 Prospect
- Thatcher Frederick N. moulder, 187 W. Main,
- Thatcher Harry G. boards 44 Court
- Thatcher Nathan N. moulder, 187 W. Main, house 60 Prospect [depot, h. 44 Court
- Thatcher Reuben H. doorman, N. Y. C. R. R.
- Thayer Angles I. bookkeeper, Court c. Stone, boards 28 Gardiner park [av.
- Thayer Cornelius J. peddler, h. 56 Saratoga
- Thayer Daniel J. fish, house Champion cor. White alley [b. 28 Gardiner park,
- Thayer Halbert G. clerk, Court cor. Stone,
- Thayer Henry, painter, 34 Mill, h. 62 Hickory
- Thayer John M. manager, Sargent & Greenleaf's, Court c. Stone, h. 28 Gardiner pk.
- Theily Julius, baker, 262 State, boards do.
- Thein George, cutter, 103 State, h. 56 Joiner
- Thein John G. cutter, 46 Mill, house Moulson near railroad
- Thein Mary Miss, boards 204 North Clinton
- Thein Michael, tailor, 204 N. Clinton, h. do.
- Theis John, saloon, 54 North Water, h. do.
- Theis Peter, carpenter, house 37 Mark
- Theis Philip, mason, house 25 Henry
- Then Christian, carpenter, house North av. near Clifford [n. Clifford
- Then Christian D. tinsmith, bds. North av.
- Theobald William, printer, 149 N. Water, boards 4 Marietta [b. Carter n. Norton
- Theobald William, shoemaker, 81 N. Water,
- Thesing Bernard, tailor, 114 State. h. at Gates
- Theurer Christian, removed to Wirtemberg, Germany
- Thiel Adam, boards 287 North Clinton
- Thiem Charles, grocer, 14 Hawkins, h. do.
- Thiem Charles, trunkmaker, foot of Rowe, boards 14 Hawkins [Hawkins
- Thiem Christian, blacksmith, Platt, house 16
- Thiem Frederick C. mason, b. 14 Hawkins
- Thiem Henry, market, 132 N. St. Paul, h. do.
- Thiem Herman G. blacksmith, h. 8 Lowell
- Thiemer Fritz, carpet layer, house 18 Weld
- Thies Matthias, stone cutter, h. 1 Catharine
- Thiese Catharine, widow, boards 18 Weld
- Thiese Wilhelm, editor, Von Nah und Fern, 145 N. Water, house 18 Weld
- Thiesson Paul, market, 3 Hudson, house do.
- Thifel Henry, laborer, house 5 Herman
- Thing Adelia P. teacher, Riley School, No. 14, boards 68 S. Union
- Thirl Charles, hairdresser, 5 Exchange, h. 93 Clifton [change, h. 13 Kelly
- Thoma Frank J. cabinet maker, 87 Exchange
- Thoma John, shoemaker, house 32 Childs
- Thoma Urban, shoemaker, house 157 Jay
- Thomas Adam, grocer, 254 State, house do.
- Thomas Alanson A. tallyman, Platt c. Kent, house 54 Cypress [b. 73 Lake av.
- Thomas Allen A. wood moulder, ft. Rowe,
- Thomas Amanda, widow, house 23 Jay
- Thomas Anna M. Miss, teacher, House of Refuge, boards 8 Bloss [avenue
- Thomas Benjamin, painter, h. 32 Caledonia
- Thomas Benjamin F. (Millington & Thomas), 2 Ely, house 39 South avenue
- Thomas Benjamin P. mason, h. 88 Cady
- Thomas Bridget, weaver, b. 230 Plymouth av.
- Thomas Charles, engineer, N. Y. C. R. R. house 26 Gorham [n. Clifford
- Thomas Charles W. carpenter, house Thomas
- Thomas Charles W. whipmaker, Allen cor. North Washington, b. 23 Jay
- Thomas Charles W. removed to Elmira
- Thomas Chester B. bookkeeper, 111 State, boards 50 Plymouth avenue
- Thomas Cornelia, widow, h. 21 Brighton av.
- Thomas Dorcas, widow, house 29 Franklin
- Thomas Earl D. pattern maker, h. 32 South Union [avenue
- Thomas Edward, student, bds 50 Plymouth

- THOMAS EDWARD L.** water pipe, 93 S. St. Paul, house 5 Livingston place.—
See page 588
- Thomas E. De Witt, salesman, 123 W. Main, h. 25 Brighton avenue
- Thomas George E. carpenter, 97 Exchange, house 74 North avenue
- THOMAS GEORGE W.** lawyer, 109 Powers' bldgs. h. 153 Tremont.—See page 511
- Thomas Harvey G. house 39 Pearl
- Thomas Henry M. clerk, 45 E. Main, bds. 21 Brighton avenue [125 Jay
- Thomas Hiram, carver, 133 N. Water, bds.
- Thomas Jeremiah, boiler maker, h. 3 Pearl
- Thomas John, shoemaker, house 125 Jay
- Thomas John jr. shoemaker, boards 125 Jay
- Thomas John R. architect, 73 Arcade, h. 27 State [donia avenue
- Thomas John W. carpenter, h. 121 Cale-
- Thomas Joseph H. carpenter, house Thomas near Clifford [Thomas
- Thomas Joseph W. carpenter, h. Clifford n.
- Thomas Josephine A. Miss. boards 93 Mt. Hope avenue [St. Paul
- Thomas Lawrence, laborer, house 131 North
- Thomas Mary Jane widow, h. 112 Broadway
- Thomas Peleg B. machinist, Exchange opp. Glasgow, house 120 Frank
- Thomas Sophia, dressmaker, h. 24 Sibley's block [n. N. St. Paul
- Thomas Stephen, laborer, house Livingston
- Thomas Walter O. student, b. 120 Frank
- Thomas William, laborer, h. 232 N. Clinton
- Thomas Wm. whitewasher, house 21 Madison
- Thomas William, engineer, bds. 65 Orange
- Thomas William C. gardener, h. 145 Hudson
- Thomas William C. deceased October, 1875
- Thomas Wm. H. agent, h. 50 Plymouth av.
- Thomas William O. clerk, 154 E. Main, h. 3 Brighton avenue
- Thompson Agnes M. dressmaker, boards 238 State [house 66 Baden
- Thompson Alexander, fireman, N. Y. C. R. R.
- Thompson Alexander, boards 19 Troup
- Thompson Arthur W. blacksmith, 277 State, boards 102 Mill
- Thompson Betsy G. widow, b. 17 Chestnut
- Thompson Caroline M. widow, h. 19 Troup
- Thompson Celia, widow, h. 114 North av.
- Thompson Charles, sailor, bds. 21 William
- Thompson Charles E. cutter, 72 Mill, bds. 55 Savannah [house 5 Pine
- Thompson Charles H. laborer, 45 Fitzhugh,
- Thompson Charles O. laborer, h. 4 Munger
- Thompson Chas. W. deceased July 25, 1875
- Thompson Charlotte, widow, h. 2 Whalin
- Thompson Cynthia, tailoress, 170 North, b. 290 East Main [Pearl
- Thompson Daniel, painter, b. Edmonds near
- Thompson Edgar, removed to Brockport
- Thompson Eliza, widow, h. 17 Briggs' block
- Thompson Frank B. shoemaker, Andrew c. North Water, boards 27 Plymouth av.
- Thompson Frank N. painter, h. Edmonds n. Pearl
- Thompson George, laborer, b. 31 S. St. Paul
- Thompson George A. fireman, N. Y. C. R. R. house 29 Hudson
- Thompson George F. removed to Troy
- Thompson George H. carpenter, b. 2 Whalin
- THOMPSON GEORGE H. & CO.** railroad contractors, East Main c. North av. h. 4 East.—See page 636
- Thompson George W. produce, h. 107 Tremont [change
- Thompson Harvey B. hostler, house 104 Ex-
- Thompson Henry W. agent, 94 E. Main, h. 39 Huntington [200 State
- Thompson Isaac, laborer, 41 Lancaster, h.
- Thompson Isaac, laborer, b. 49 University avenue
- Thompson Isaac H. (*Thompson & Lamb*), 289 State, house 13 Jay [Union
- Thompson Isabella, widow, house 81 S.
- Thompson James, laborer, bds. 92 Front
- Thompson James, laborer, b. 49 University av.
- Thompson James, laborer, house 101 Caledonia avenue
- Thompson James E. undersheriff, Court House, house 77 Monroe avenue
- Thompson James R. broker, 45 Arcade, h. 75 William [14 E. Main n. Gibbs
- Thompson James R. clerk, 147 State, boards
- Thompson John, laborer, 178 Plymouth av. house 12 Strong
- Thompson John H. teller, Flour City Nat'l Bank, 1 Powers' bldgs. h. 36 Allen
- THOMPSON JOHN W.** fruit plate manuf. 18 Palmer's block, h. do.—See page 527
- Thompson Joseph, health inspector, house 22 Delevan
- Thompson Joseph, wood moulder, 22 South St. Paul, house 2 Marshall
- Thompson Joseph A. salesman, 13 E. Main, boards 146½ W. Main [house do.
- Thompson Joshua, grocer, 126 Plymouth av.
- Thompson Julia, b. Nichols n. Jennings
- Thompson Laura N. widow, h. 39 Reynolds
- Thompson Martha, widow, b. 6 Concord av.
- Thompson Mary Mrs. widow, h. 238 State
- Thompson Mary, boards 37 N. St. Paul
- Thompson Melvin, hackman, 171 State, bds. Mill near Mumford
- Thompson Mirittee, widow, b. 51 East av.
- Thompson Nathaniel, h. 14 East Main near Gibbs [avenue
- Thompson Paul, gardener, h. 49 University
- Thompson Reuben, hostler, r. 118 W. Main, house 100 Exchange [house do.
- Thompson Robert, carpet weaver, 84 Lyell,
- Thompson Samuel, laborer, h. 115 Champlain
- Thompson Sarah Miss, seamstress, boards 26 Clifton [Cady
- Thompson Susanna, widow, house Olcan c.
- Thompson Thomas, machinist, Brown cor. Jones, house Frank near Lorimer
- Thompson Thomas H. machinist, Brown c. Jones, boards Frank near Lorimer
- Thompson Wesley S. agent, h. 88 West av.
- Thompson William, printer, boards 238 State
- Thompson William, boat builder, house 26 Hamilton place
- Thompson William A. clerk, b. 107 Tremont
- Thompson William E. shoemaker, 15 Mill, boards York House [7 Sycamore
- Thompson William H. cattle-policeman, h.

HENRY C. WISNER,

**PARRIAN BUSTS AND FIGURES,
No. 33 STATE STREET.**

- Thompson William H. millwright, 127 Mill, boards 16 Allen
- Thompson Wm. M. tailor, h. 3 Trowbridge
- Thompson Wm. M. clerk, County Clerk's Office, Court House, b. 184 N. St. Paul
- Thompson William N. machinist, boards Frank near Lorimer
- Thompson William S. house 3 East avenue
- Thompson & Lamb (*I. H. Thompson and C. L. Lamb*), grocers, 289 State
- Thomson Alexander, fireman, Erie Railway, boards 12 Strong
- Thomson David, fireman, b. 12 Strong [h. do.
- Thomson George, carpenter, 40 Tremont,
- Thomson John, engineer, N. Y. C. R. R. h. 34 Hudson [13 North Ford
- Thomson John, clerk, 53 West Main, boards
- Thomson Robert, blacksmith, h. 12 Strong
- Thomson Robert jr. fireman, Erie Railway, boards 12 Strong
- Thomssen George N. student, Rochester Theological Seminary, b. 118 Alexander
- Thon Charles, tailor, house 35 Sellinger
- Thon Ernst, cutter, 76 Mill, house 17 Morris
- Thon Gottlieb, shoemaker, 27 Whitney, h. do.
- Thor Frank, tailor, h. 117 Jay [37 Orange
- Thorn George, blacksmith, rear 83 Front, h.
- Thorn George jr. blacksmith, r. 83 Front, boards 37 Orange [125 Meigs
- Thorn Henry, laborer, 178 Plymouth av. b.
- Thorn John W. laborer, house 125 Meigs
- Thorn Martha A. widow, boards 110 Plymouth av.
- Thorn Thomas, carpenter, h. 18 Atkinson
- Thorne Francis, laborer, house 42 Pearl
- Thornton Adeline Miss, boards 50 Court
- Thornton William H. student, University of Rochester, boards 16 Canal
- Thorpe Kitty S. dressmaker, bds. 13 George
- Thrall George W. clerk, Erie Ry. freight office, boards 10 Glasgow
- Thrall Sarah E. widow, house 10 Glasgow
- Thrasher Fletcher M. confectioner, 89 North avenue, house do. [E. Main, h. do.
- Thrasher Margaret E. Mrs. dressmaker, 149½
- Threadgoold John, laborer, house 18 Ontario
- Threadgoold Maria, widow, h. 4 S. Union
- Threadgoold William, baker, b. 4 S. Union
- Thurber Lucy H. Miss, house 3 Newton blk.
- Thursorn Frederick, gardiner, h. Goodman n. Schanck av. [office, h. 14 Channing
- Thurston Dudley S. clerk, North st. R. R.
- Tibbetts Edward, produce buyer, bds. 6 Ely
- Tibbills Charles, confectioner, h. 7 Asylum
- Tibbills Frederick, removed from city
- Tibbills Henry F. agent, removed from city
- Tibbitts Samuel C. removed from city
- Tice David H. carriage painter, 3 Canal, b. 7 Warehouse
- Tice Henry, mason, house 57 Scrantom
- Tice James, laborer, 13 Warehouse
- Tice Joseph L. woodworker, h. 7 Granger
- Tice Stephen (*Tice & Barnard*), house 7 Warehouse
- Tice Walter M. sawyer, boards 7 Warehouse
- Tice & Barnard (*S. Tice and Wm. C. Barnard*), market, 26 Allen
- Tichenor Bethia, widow, h. 301 N. Clinton
- Tichenor George F. engineer, N. Y. C. R. R. house 1 Anderson avenue [house do.
- Tichner Solomon, dry goods, 83 Chatlam,
- Tiefel J. George, mason, h. 56 Hamilton pl.
- Tierney Edward J. machinist, house Ontario near Union
- Tierney Elizabeth, widow, h. 46 Cameron
- Tierney James, foreman, house 46 Ontario
- Tierney James T. stockkeeper, 14 Mumford, boards 69 William
- Tierney Jane, widow, boards 3 Cobb
- Tierney John T. moulder, boards 46 Ontario
- Tierney Martin A. cooper, 1 St. James pk. boards 46 Cameron
- Tierney Michael, miller, h. Whitney c. Lime
- Tierney Michael L. saloon, 3 Monroe avenue, house do. [boards 46 Cameron
- Tierney Myles W. screwmaker, 123 Mill,
- Tierney Owen, coachmaker, bds. Whitney corner Lime [Paul, h. 69 William
- Tierney Patrick, marble polisher, 122 S. St.
- Tierney Patrick H. bridge tender, boards 46 Ontario
- Tiersen Abraham, laborer, house 18 Vose
- Tiersen Isaac, farmer, Norton near Waring road, house Norton n. North [W. Maple
- Tietenberg Charles, cigarmaker, 3 Eagle, h. 5
- Tietenberg Emil E. cigarmaker, h. 3 Prospect
- Tietenberg Fred. cigarmaker, 21 Front, h. 36 Thomas [av. b. 22 Channing
- Tietenberg Louis, cigarmaker, 9 Caledonia
- Tiffany Charles V. salesman, 7 Exchange, boards 123 Plymouth avenue
- Tilden Alonzo, laborer, house 16½ Spring
- Tillson Margaret, widow, house 42 Kirk
- Tilt Mathilda Miss, clerk, 124 W. Main, bds. 136 S. St. Paul [House
- Tilton John S. shoemaker, 15 Mill, b. York
- Timens Michael, switchman, house 16 Wait
- Timerman Hiram, carpenter, h. 58 Adams
- Timerman John, capenter, 129 Mill, house 91 Weld
- Timerman Peter, carpenter, b. 63 W. Maple
- Timm John, laborer, house 129 Wilder
- Tines John, engineer, 3 Canal, h. 31 Lime
- Tines John G. machinist, 3 Canal, b. 31 Lime
- Tines Mary L. seamstress, 31 Lime, bds. do.
- Tinker Horace, sewing machines, 124 West Main, boards National Hotel
- Tinkler Joseph, butcher, house 121 N. Union
- Tippett Henry, shoemaker, 160½ North av. house rear 4 Tyler
- Tippetts Eliza Mrs. flower manuf. h. 43 State
- Tippetts William H. student, bds. 43 State
- Tischer Benjamin, carpenter, house 22½ Scio
- Tischer John C. carpenter, house 65 Hudson
- Tischler Peter, laborer, house 27 Woodbury
- Titus E. Mate Miss, bds. 37 Mt. Hope avenue
- Titus Stephen, agent, house 69 Court
- Toan John S. builder, boards 10 King
- Toates Joseph K. millwright, h. Lyell near Myrtle
- Toaz Mary J. boards West corner Lorimer
- Toaz Robert K. laborer, Irving Mills, house 14 West [Lorimer
- Toaz Samuel D. carpenter, bds. West corner
- Toaz Thomas K. carpenter, ft. White, bds. 14 West

- Toaz William K. moulder, 145 N. Water, h. 9 St. Clair
- Tobin Ann, widow, house 13 Harrison
- Tobin Catharine, widow, house 19 Stone
- TOBIN EDWARD**, blacksmith and carriage maker, 4 Ely n. S. St. Paul, house 24 Galusha.—See page 605 [b. 19 Stone]
- Tobin Eliza Miss, dressmaker, 12 E. Main,
- Tobin John J. tinsmith, boards 13 Harrison
- Tobin Mary E. shoefitter, bds. 13 Harrison
- Tobin William A. carver, 8 Allen, boards 13 Harrison [Reynolds]
- Tock Christian, dyer, Mill c. Platt, house 23
- Todd Chauncey S. manager, Howe Sewing Machine Co. 69 State, h. 10 George's pk.
- Todd John, nurseryman, h. 20 Phelps avenue
- Todd Wright, deceased April, 1875
- Toebe Henry A. printer, 23 W. Main, boards 25 Marietta
- Toebe William H. shoemaker, h. 25 Marietta
- Toense Henry, laborer, boards 19 Hanover
- Toeppe John, currier, house 37 Atwater
- Toewe William, chairmaker, house 29 McDonald avenue
- Tole Annie, servant, 18 Prospect
- Tole John, bricklayer, boards 16 Litchfield
- Tolievor James, hostler Roch. Driving park, boards do.
- Toll Henry, carpenter, house 97 Orchard
- Tolmie Lottie, papermaker, 32 N. Water, b. 35 Asylum [18, boards 11 Hudson]
- Tomlin Anna J. teacher, Concord school, No.
- Tomlin John D. insurance surveyor, house rear 11 Hudson
- Tomlin Samuel, house 11 Hudson
- Tompkins Caroline, widow, house 2 Church
- TOMPKINS CHARLES R. & CO. (H. F. Smith)**, wood working machinery manufacturers, Mill c. Factory, h. 12 Bolivar.—See page 673 [Washington]
- Tompkins Charlotte, widow, house 18 North
- Tompkins D. P. salesman, 33 State, house at Geneva
- Tompkins Eleanor L. Mrs. h. 75 Fitzhugh
- Tompkins Eliza Miss, b. 49 Jones av. cor. Thompson
- Tompkins Hannah G. widow, b. 46 Chestnut
- Tompkins Mary E. stitcher, h. 39 Sibley's blk.
- Tompkins John Mrs. widow, b. 49 Jones av.
- Tompkins Mary F. saleswoman, 52 State, b. 74 Troup
- Tompkins Rebecca, widow, bds. 12 Bolivar
- Tompkins Silas E. carpenter, Minerva alley, house 8 East park [Chestnut]
- Tompkins William M. painter, house 46
- Toms Richard, removed to Charlotte
- Tone Anne, widow, house 67 East avenue
- Tone Bernard W. (*Stettheimer, Tone & Co.*), 8 State, h. Lake av. near Lake View pk.
- Tone Charles E. clerk, 53 E. Main, boards 143½ East Main
- Tone Joseph C. teller, 8 State, b. 67 East av.
- Tone Theobald W. (*Stettheimer, Tone & Co.*), 8 State, boards 67 East avenue
- Toogood George, nurse, boards 42 Greig
- Toogood John, removed to England
- Toogood Thomas, coachman, 40 Plymouth avenue, house 42 Greig
- Toohy John, shoemaker, Andrews cor. N. Water, house 19 Trowbridge
- Toohy John jr. shoemaker, b. 19 Trowbridge
- Toohy Margaret, widow, b. r. 21 Monroe av.
- Toohy William H. shoemaker, 111 State, b. 19 Trowbridge
- Toohy Michael J. shoemaker, Andrews cor. N. Water, boards 83 William
- Toole Edward, quarryman, house 29 Bolivar
- Toole Edward jr. teamster, Oak cor. Smith, boards 29 Bolivar
- Toole Frank, machinist, b. 188 Champlain
- Toole George, laborer, house 188 Champlain
- Toole James, clerk, boards 29 Bolivar
- Toole Mary, dressmaker, boards 29 Bolivar
- Toole Nellie, servant, Whitcomb House
- Toole Patrick H. shoemaker, h. Sumner n. Hunter
- Toole Thomas, laborer, house 68 W. Maple
- Toole William J. (*Hastings & Toole*), 264 State, boards 29 Bolivar
- Toomey Peter, laborer, house 26 Hill
- Toomey Timothy, switchman, house 41 Kirk
- Topfal Herman, harnessmaker, 20 Market, boards 57 Herman
- Topham Edward, stovemounter, h. 48 Hunter
- Topham Elizabeth, widow, h. 82 Caledonia avenue [edonia avenue]
- Topham Hannah, dressmaker, boards 82 Caledonia
- Topham John P. engineer, No. 3 engine house, house 212 Brown
- Topham Sarah, widow, h. 141 S. St. Paul
- Topham William, teamster, 187 W. Main, h. 52 Caledonia avenue [119½ do.]
- Topping Wm. R. clerk, 13 E. Main, boards
- Torkington Charles F. h. 92 Caledonia av.
- Torkinton Sarah R. costumer, 160 W. Main, house do.
- Tormey Thomas, laborer, bds. 145 W. Main
- Torrance Chas. F. messenger, City Bank, b. East avenue cor. Upton park [ton]
- Torrance Floyd R. clerk, b. 36 N. Washington
- Torrance George W. house 134 West avenue
- Torrey Ransom, salesman, 53 E. Main, bds. Clinton Hotel
- Torrey Saml. boards Norton n. N. St. Paul
- Torrey Samuel H. house 11 Troup
- Toughill George, blacksmith, h. 280 North
- Tousey Azariah C. boards 120 Bartlett
- Towan James H. removed to Boston, Mass.
- Tower Anson K. (*Tower & Herrick*), boards 28 Adams [ington]
- Tower Margaret S. widow, bds. 27 S. Washington
- Tower Mary, widow, house 28 Adams
- Tower & Herrick (*A. K. Tower and J. Herrick*), stationers, 6 Exchange
- Towner Carrie, clerk, boards 12 Ward
- Towner Frank D. salesman, bds. 12 Ward
- Towner Heman D. grocer, house 12 Ward
- Towner Nellie A. clerk, boards 12 Ward
- Townsend Alexander C. h. Cataract near N. St. Paul [sity, bds. 10 Elizabeth]
- Townsend Calvin, prof. Roch. Bus. University of Rochester, boards 37 Chestnut
- Townsend Charles C. student, University of Rochester, boards 37 Chestnut
- Townsend Charles J. student, University of Rochester, boards 47 North
- Townsend Gilbert G. house 74 Frank

Townsend Helene, boardinghouse, 173 East Main [Johnston's blk.]
 Townsend Homer, coachmaker, boards 24
 Townsend Jessie W. clerk, b. 227 E. Main
 Townsend Josiah K. painter, house 54 Allen
 Townsend Julius L. principal, Franklin School No. 6, house 16 Greenwood av.
 Townsend Laura, gilder, 38 Gorham, bds. 1 Sheridan park [41 St. Joseph
 Townsend Wm. (*Townsend & Wiseman*), h. Townsend William K. (*Townsend & Sullivan*), 90 Powers' bldgs. house 227 E. Main
 Townsend & Sullivan (*W. K. Townsend and H. J. Sullivan*), lawyers, 90 Powers' bldgs.
TOWNSEND & WISEMAN (*W. Townsend and A. Wiseman*), shoemakers' tools, Andrews cor. N. Water.—*See page 665*
 Townson Andrew J. bookkeeper, 73 East Main, boards 91 Scio
 Townson Frances, widow, house 91 Scio
 Townson James, hostler, Chapman house, h. 44 Sycamore [91 Scio
 Townson Libbie, cashier, 73 E. Main, bds. Tozier Berk, artist, boards 24 N. St. Paul
 Trabert Joseph, cabinetmaker, house 146 Campbell [Campbell c. Wackerman
 Trabot Joseph, sawyer, lower falls, house Tracy Clark D., Evening Express Printing Co. 23 West Main, house 8 Franklin sq.
 Tracy Hartson B. boards 36 Vick park
 Tracy Henry D. stavecutter, Oak n. Jay, h. 54 Clifton
 Tracy Jas. E. driver, 23 Hill, boards do.
 Tracy Jeremiah, mineral water, 23 Hill, h. do.
 Tracy John T. bookkeeper, 63 Front, boards 23 Hill
 Tracy Joseph J. soda water maker, h. 25 Hill
 Tracy Kate, laundress, Congress Hall, b. do.
 Tracy Thomas, laborer, 20 Court, bds. 5 Ely
 Tracy William H. clerk at weighlock, boards 23 Hill
TRADERS' NATIONAL BANK, 35 West Main cor. Exchange.—*See page 494*
 Trainer Edward, student, University of Roch. boards 110 University avenue
 Trainor John, maltster, 65 N. Water, house 15 Catharine [Litchfield
 Trainor John, coachman, 5 Canal, house 16
 Trainor Mary, widow, boards 15 Catharine
 Trant Jeremiah, grocer, 16 Ward, house do.
 Trapp Jacob, lather, boards 9 Lime
 Trapp John, lather, boards 9 Lime
 Trapp Joseph, lather, house 9 Lime
 Trapp Joseph jr. lather, boards 9 Lime
 Traub Louis H. removed to Syracuse
 Traugott Catharine M. widow, h. 58 William
 Traugott Charles J. mason, house 99 Scio
 Traugott Christian, deceased April 13, 1876
 Traugott Elizabeth Miss, boards 58 William
 Traugott Frederick G. mason, h. 78 William
TRAUOGOTT WILLIAM, grocer, 35 Scio, house 208 East Main.—*See page 556*
 Traver Charles L. pawnbroker, 10½ South St. Paul, boards do.
 Traver Charles M. bookkeeper, b. 24 South avenue
 Traver Edward, boatman, bds. 71 Saxton

Traver Henry, clerk, 79 E. Main, boards 10½ South St. Paul
 Traver John J. boatman, house 71 Saxton
 Treadwell George E. carpenter, h. Hollister corner Lansing
 Treat Wright, farmer, b. Hume n. Genesee
 Trebert Henry, machinist, 138 Mill, h. 23 Mark
 Trefry David F. removed from city
 Trekel Frederick, laborer, house 33 Weeger
 Trenaman Geo. J. currier, h. 43 Lancaster
 Trenaman Richard, tanner, 18 North Water, house 34 Court
 Trenaman Thomas, machinist, h. 28 Galusha
 Trenbeth Richard, carriagemaker, 3 Elizabeth, house 33 Tappan
 Trenkler Anton, carver, 133 N. Water, bds. 143 Lyell [Whitney
 Trenkler F. Joseph, laborer, house Lyell n.
 Trenkler Joseph, cabinetmaker, h. Thorn al. n. Caledonia av. [boards do.
 Trenkle John, brewer, 111 North St. Paul,
 Trentman Francis H. gardener, house 18 Gregory
 Trentman Frank E. gardener, b. 18 Gregory
 Trentman Henry A. upholsterer, 184 State, boards 18 Gregory
 Trennheuser Mathew, laborer, b. 122 Front
 Trevor Ann, widow, house 10 Waverley pl.
 Trevor Hall, East avenue cor. Alexander
 Trevor John, deceased July 5, 1875
 Treyer Michael, blacksmith, 188 State, house 317 N. Clinton [N. Clinton
 Treyer William, blacksmith, 188 State, h. 323
 Trimble John W. expressman, 83 State, h. 340 Brown [avenue
 Trimmel Caroline, widow, bds. 157 Pinnacle
 Trimmer Benjamin T. grain scourer, Mill foot Platt, house 83 South avenue
 Trimmer D. Orville, clerk, Congress Hall, boards do. [South av.
 Trimmer Edwin W. grain scourer, boards 83
 Trimmer Elliott E. removed to Gates
 Trimmer Sylvester, removed to Gates
 Tripp Edwin, seedsman, house 160 West av.
 Tripp Elzezer W. ice dealer, 130 Frost av. house do. [121 Tremont
 Tripp George B. agent, 53 East Main, house
 Tripp Henry A. laborer, boards 16 Syke
 Tripp Hiram M. carpenter, boards Smith c. Saxton
 Tripp Ira, boards 121 Tremont [Wilder
 Tripp James A. tanner, house Colvin opp.
 Tripp James S. carpenter, h. 17 Hickory
 Tripp Jefferson J. carpenter, house 92 Pearl
 Troan John Y. porter, 16 Exchange, house 82 Hunter [Grand c. Whalin
 Troening Charles, lithographer, 7 Market, b.
 Troening Henry, hatter, h. Grand c. Whalin
 Troird Jacob, saloon, Wilder c. Saxton, h. do.
 Tromblee Francis, laborer, house 14 Bay
 Tromblee Frank, teamster, h. 96 North av.
 Trompeter J. F. August, frame maker, 126 State, house 35 Galusha
 Trompeter Mary M. widow, house 69 Martin
 Trost Catharine, widow, house 50 W. Maple
 Trost Eva, domestic, boards 11 Arnold park
 Trost Joseph, grocer, 172 Pinnacle avenue house do.

- Trost William, moulder, 20 Court, house Pinnacle av. cor. Henrietta avenue
- Trott Clara, hairworker, bds. 45 Lancaster
- Trott Julius, teamster, house 45 Lancaster
- Trott Mary Miss, dressmaker, b. 45 Lancaster
- Trotter Charles W. (*Trotter & Stone*), house 53 University avenue [Main, bds. do.]
- Trotter Eliza Miss, dressmaker, 137 East
- TROTTER & STONE** (*C. W. Trotter and G. Stone*), furnaces, ranges, &c. 29 Exchange.—*See page 626*
- Trousdall Eliza, widow, house 72 Jay
- Trout Charles, machinist, bds. Hague near Campbell [Campbell]
- Trout Frederick, laborer, house Hague near Trow Alice, milliner, boards 341 State
- True Charles W. (*McBride and True*), 134 E. Main, house 14 Marshall
- True George E. salesman, 36 Exchange, house at Batavia
- True Maria H. widow, house 14 Marshall
- True Maria T. widow, house 56 Chestnut
- True Mary, chambermaid, Osburn House
- True Mary H. teacher, 12 S. Washington, b. do.
- True Mary S. widow, house 155 Brown
- True William F. broom maker, 5 N. Ford, boards 179 Brown [h. 5 Madison]
- Truesdale George, lawyer, 111 Powers' bldg.
- Truesdale Nancy, laundress, 126 Mt. Hope av.
- Truesdell Jenny, saloon, 59 Chatham, h. do.
- Truex George, bookkeeper, boards 8 Gorham
- Truex John H. (*Forsyth & Co.*), 5 Andrews, house 8 Gorham
- Trummel John, teamster, bds. 94 N. Clinton
- Trummel Matthew, teamster, b. 94 N. Clinton
- Trump Henry Rev. house 76 Asylum
- Trump William, carpenter, h. 54 Asylum
- Tryon Emily S. boards 29 South Union
- Tryon Julia C. Miss, house 29 South Union
- Trzeciak Alexander, teacher, Free Academy, boards 91 Scio
- Trzeciak John, gardener, house 91 Scio
- Tschernich Gustave, tailor, h. 19 Hanover
- Tschernich Minnie Mrs. saloon, 19 Hanover, house do. [do.]
- Tschetter Henry, market, 116 Pinnacle av. h.
- Tschirch Ernest, clergyman, h. 1 Anson pk.
- Tschirch Ellen H. teacher, Whitney School, No. 17, boards 1 Anson park
- Tubbs George L. (*Boyd & Tubbs*), 153 East Main, house 15 Stillson
- Tubbs John, hostler, house 13 Sycamore
- Tubbs J. Nelson, civil engineer, water works, City Hall, house 32 Glasgow
- Tuck Charles H. shoemaker, 15 Mill, boards 22 Elm [Hamilton place]
- Tucker John, trimmer, 87 Exchange, bds. 10
- Tucker Henry D. (*Tucker & Bonen*), 19 Smith's block, bds. 4 N. Washington
- Tucker Joseph L. rector Christ church, house 53 East avenue
- Tucker Margaret, widow, 29 Munger
- Tucker Peter, shoemaker, 12 South av. house Mansion near Violetta
- Tucker & Bowen (*Henry D. Tucker and Adna Bonen*), lawyers, 19 Smith's block
- Tuckett Charles, carpenter, h. r. 3 Lorimer
- Tuehzzum John C. house 10 Hoeltzer
- Tuety George, cooper, Smith near Erie canal, house 133 Jones
- Tuety Maggie Miss, boards 135 Jones
- Tuety Peter F. deceased May 18, 1876
- Tuety Peter J. cooper, Smith n. Erie canal, house 135 Jones [S. Washington]
- Tugard William, hostler, 11 Atkinson, b. 41
- Tuinman George, laborer, h. 13 Langham
- Tuinman Sarah, widow, house 2 Vose
- Tullar Nancy, widow, boards 18 Champion
- TULLY FRANCIS**, stoves, ranges, plumbing, &c. 67 Exchange, house 30 Greig.—*See page 577*
- Tulley Francis jr. clerk, 65 Exchange, house 45 Edinburgh [Summer]
- Tulley Peter, carpenter, h. Champlain near
- Tulley William, caulker, h. 4 Summer alley
- Tumilty James, b. Plymouth av. c. Magnolia
- Tumilty Mary, widow, house Plymouth av. corner Magnolia [avenue]
- Tumuely Lawrence, nurse, h. 250 Plymouth
- Tunbridge Bros. (*C. and W. B. Tunbridge*), painters, 40 West avenue
- Tunbridge Charles, (*Tunbridge Bros.*), house 6 Madison
- Tunbridge Mary, widow, h. 30 Trowbridge
- Tunbridge William B. (*Tunbridge Bros.*), bds. 30 Trowbridge [31 Catharine]
- Tuohey Helen A. milliner, 137 E. Main, bds.
- Tuohey Jeremiah, laborer, h. 31 Catharine
- Turk Edward F. carpenter, b. 2 West Troup
- Turk Herbert, builder, house 2 West Troup
- Turnbull Adam W. agent, 134 E. Main, house 59 Charlotte
- Turneare Robert, boot treer, h. 7 Charlotte
- Turner Alexander, boards 28 Sophia
- Turner Ann, widow, house 3 St. Joseph
- Turner B. Mrs. hairwork, 131 E. Main, h. do.
- Turner Chas. carriage trimmer, h. 8 N. Ford
- Turner Charles C. boards 6 Henion place
- Turner Charles M. hostler, 21 S. Clinton, bds. Broadway near Howell [Howell]
- Turner Clementine A. Mrs. bds. Broadway n.
- Turner Eliza J. forewoman, 44 Exchange, h. 164 State
- Turner Gardiner, boards 2 Charlotte
- Turner George B. 131 East Main, house do.
- Turner Henry H. clerk, 69 West Main, bds. 28 Sophia [Bartlett]
- Turner Horatio, clerk, 129 State, house 75
- Turner Jennie, widow, bds. 9 Trowbridge
- Turner John, tailor, house Allmeroth near Henrietta avenue
- Turner John, clerk, 62 State, house 31 Prince
- Turner Elizabeth Mrs. corsets, 28 Sophia, house do. [Sophia]
- Turner John, machinist, 122 Mill, boards 28
- Turner John M. shoefinisher, 55 Mill, boards Broadway near Howell
- Turner Mary A. fancy goods, 320 State, h. do.
- Turner Mary A. widow, house 59 Spring
- Turner Matthew, stavecutter, bds. 112 Jones
- Turner Mortimer O. stonecutter, b. 81 Hunter
- Turner Nehemiah H. carpenter, boards 6 Henion place
- Turner Price T. house 30 Prospect
- Turner Richard E. carpenter, Chili road n. West avenue, house Thurston road

Turner Richard S. removed from city
 Turner Simon, carpenter, house 112 Jones
 Turner Thomas, tinsmith, 26 S. St. Paul, h. rear 38 Stillson
 Turner Thomas L. (*Turner & Clement*), 122 Mill, house 124 N. Clinton
 Turner & Clement (*T. L. Turner and F. H. Clement*), machinists, 122 Mill
 Turney Daniel, foreman, Erie Railway repair shop, house r. 13 Greig [31 Glasgow
 Turpin Charles H. photographer, 78 State, b.
TURPIN FREDERICK, mouldings, picture frames, &c. 110 Front, house 32 Gorham.—*See page 583*
 Turpin Louisa, widow, h. 17 Greenwood av.
 Turpin Thomas H. (*Summers & Turpin*), 43 N. Water, house 31 Glasgow
TURVER CHARLES H. carpenter and builder, 39 S. Ford, h. do.—*See page 582*
 Tusch Henry, laborer, boards 111 North av.
 Tuschong Michael, shoemaker, Centre near State, house 106 Saxton [39 Campbell
 Tuschong Nicholas, clerk, 14 Mumford, bds.
 Tuschong Peter, tailor, house 39 Campbell
 Tuton Sarah C. boarding house 27 N. St. Paul
 Tuton Wm. boards 27 North St. Paul
 Tuttle Charles F. salesman, 73 N. Water, h. 6 Tappan [Chestnut
 Tuttle Charles N. clerk, Platt c. Kent, b. 10
 Tuttle David B. clerk, Olean opp. Frost av. boards 162 Plymouth avenue
 Tuttle Edward A. (*Tuttle & Persons*), house 128 West av. [cade, bds. 46 Oak
 Tuttle Geo. W. (*Devenport & Tuttle*), 33 Ar-
 Tuttle Horace J. student, University of Rochester, boards 198 Alexander
 Tuttle Margaret, widow, house 6 Tappan
 Tuttle Melissa A. widow, b. 89 Mt. Hope av.
 Tuttle Myron A. agent, b. 119½ East Main
 Tuttle Nellie A. dressmaker, boards 89 Mt. Hope avenue
 Tuttle Ruth, widow, house 7 Stone
 Tuttle Washington I. bookkeeper, Olean opp. Frost av. boards 23 Frost av.
 Tuttle Willis, house 70 Oak
 Tuttle & Persons (*E. A. Tuttle and L. I. Persons*), corsets, 172 West Main
 Twaig Jeremiah A. policeman, City Hall, house 31 Kent
 Twamley Patrick, laborer, h. 119 Whitney
 Twigh Margaret, widow, bds. 24½ Bolivar
 Twist Charles H. machinist, 116 Mill, h. 13 Sanford
 Twist Geo. mason, boards 34 Pinnacle av.
 Twist James Mrs. house 47 Charlotte
 Twist Oliver, mason, house 2 Weld
 Twist Wm. mason, house 149 E. Main
 Twitchell Frank B. billiards, 41 E. Main, h. 7 Howell [7 Howell
 Twitchell John E. clerk, 41 E. Main, boards
TYLER CHARLES M. insurance agent, 40 E. Main, house 3 Grove.—*See page 510*
 Tyler Henry L. boards Farmers' Hotel
 Tyler Jacob, boiler maker, house Strong n. Genesee
 Tyler John S. deceased, 1875
 Tyler Joseph, laborer, h. Monroe avenue n. Boardman

Tyler Richard B. foreman, 129 State, house 1 Waverley pl.
 Tyler Sylvia, widow, boards 4½ Erie
 Tyrrell Sarah, widow, house 17 Delevan
 Tytler Alexander, salesman, 16 Exchange, h. 32 Park avenue
 Tytler Ann G. stitcher, boards 98 Strong
UBBINK HENDRICK, laborer, house Goodman cor. Park avenue [Lake av.
 Ubel Rosa, widow, boards McCracken near Udall Elizabeth C. Miss, teacher, boards 49 William
 Ude August, stone cutter, h. 39 Buchan park
 Udell Wm. C. mason, house 26 St. Clair
 Uebel August F. tailor, 21 E. Main, house 44 Delevan
 Uebel Frank, tool maker, house 5 Caspar
 Uebel George, laborer, house 122 Orange
 Uebel Harmon, grocer, 39 Reynolds, house 85 Cady
 Uebel Oscar, tailor, boards 44 Delevan
 Uehlin Andrew, shoemaker, 124 Front, bds. 171 N. St. Paul
 Uehlin Andrew, driver, Rochester Brewing Co. house 1 Cliff [27 Cole
 Uehlin J. Jacob, engineer, 124 Front, house
 Uehlin Wm. C. shoemaker, 83 N. Water, b. 27 Cole
 Uffindale Geo. peddler, 144 East Main
 Uhl Peter L. engineer, 12 Front, house 271 Brown [h. 1 Joiner
 Uhland Bernard, machinist, Shawmut bldg.
 Uhland Henry, painter, 3 Canal, house 11 Catharine
 Uhlin Geo. laborer, foot Cliff, house do.
 Ulbrig Albert, mason, house 18 Caroline
 Ulmer Michael, carpenter, house Fifth av.
 Ulovich Louis, peddler, boards 4 Hamburg
 Ulrich Frederick, grocer, 69 Monroe avenue, house do. [b. 13½ East av.
 Ulrich John, carriage trimmer, 145 E. Main,
 Ulrich John, laborer, house 16 Hoeltzer
 Ulrich Joseph, house 1 Franklin
 Ulrich Maria, widow, bds. 185 North Clinton
 Ulrich Philip, peddler, house 51 Campbell
 Ulscht Adam, machinist, boards 23 Pryor
 Ulscht Frederick, grinder, 136 Mill, house 55 Hanover
 Ulscht John, tailor, house 4 Elizabeth place
 Ulscht Lorenz, mason, house Flower
 Ulton Mary Miss, stitcher, boards 105 Adams
 Ulton Michael, hackman, house 105 Adams
 Underberg Morris, peddler, h. 42 Catharine
 Underhill Charles F. house 2 Oak
 Underhill David, bookkeeper, 28 W. Main, boards 28 Spring
 Underhill George, deputy collector, h. 107 Plymouth avenue
 Underhill Geo. nurse, City Hospital, bds. do.
 Underhill Geo. Mrs. fancy goods, Tremont c. Plymouth avenue, house do.
 Underhill Henrietta S. widow, b. 49 Bartlett
 Underhill James D. shoemaker, 4 Allen. b. 19 Bolivar
 Underhill Robert L. paper hangings, house 28 Park av. [Bolivar
 Underhill Roswell W. carpenter, house 19

Underhill Samuel B. vice-pres. Kelly Lamp Works, 118 Mill, house at Brooklyn

Unglink Jacob, cabinet maker, 184 State, h. 23 Buchan pk. [canal, h. 96 St. Joseph

Unglink John, cabinet maker, Jay cor. Erie

Unholz Albert, pastor Evangelical association, St. Joseph cor. Nassau, h. 72 Joiner

UNION & ADVERTISER CO. 82 West Main.—See page 530

United States Express Co. 35 Exchange

University of Rochester, Prince c. College avenue

Unsermann Chas C. laborer, house 13 Hope

U. S. Weather office, 212 Powers' buildings

Updike William, agent, h. 27 Plymouth av.

Updike Scott W. saucemaker, 71 Exchange, house 32 Spring [Asylum

Upson George, carpenter, 3 North av. b. 61

Upson Joseph S. clerk, 173 E. Main, h. 14 Sibley's block

UPTON CHARLES E. cashier, City Bank, 34 State, house East av. cor. Upton pk.—See page 495

Upton Clarence H. real estate, 61 Powers' bldgs. boards 77 East avenue

Upton David, house 88 Kent

Upton David A. foreman, house 71 Bartlett

Upton Elvira E. widow, house 77 East av.

Upton Frank S. prest. and treas. Kelly Lamp Works, Mill c. Furnace, h. Saratoga av. corner Jones avenue

Upton James, miller, 5 Aqueduct, h. 252 State

Upton James H. fireman, house 27 Bolivar

Upton Willard, boards National Hotel

Ursprung Charles, machinist, house Hudson

Ursprung Henry, painter, b. Allmeroth near Henrietta avenue

Ursprung Jacob, machinist, house 31 Hudson

Ursprung Jacob G. machinist, Brown corner Jones, boards 116 Chatham

Uschold Joseph, painter, h. 119 West Maple

Uslar Edward E. entry clerk, 16 Exchange, boards 79 Reynolds

Uslar Ernst, nurseryman, h. 79 Reynolds

Utman James T. baggageman N. Y. C. R. R. boards Waverley House

Utz Henry J. shoemaker, boards 57 Nassau

VACUUM OIL COMPANY, 128 Powers' buildings.—See page 681

VACUUM OIL CO.'S PRINT'G OFFICE, 6 State.—See opposite page 576

Vaders Frederick J. C. carriagemaker, 3 Canal, boards 9 Ford

Vaessler Anna, widow, house 6 Almira

Vaessler Max J. cutlery manuf. 113 North Water, boards 6 Almira

Vaessler Otto, deceased, November, 1875

Vaeth Jacob, hairdresser, 106 N. Clinton, h. 139 N. Clinton [139 N. Clinton

Vaeth Louisa, hairdresser, 106 N. Clinton, b.

Vaeth Richard, watchmaker, 146 State, bds. 139 North Clinton

Vahue Ezra F. carpenter, house 148 Lyell

Vahue Frank, North street engine house, h. 127 North Clinton

Vahue Frederick C. teamster, bds. 148 Lyell

Vail Jeremiah, clerk, 71 State, b. 82½ State

Vail John J. shoemaker, 15 Mill, bds. York House

Valentine Anna, widow, b. 84 West avenue

Vamp Albert, laborer, house 22½ Scrantom

Vamp Christopher, teamster, h. 22½ Scrantom

Van Aalst William, gardener, h. Hudson n. Norton

Van Aken Carrie, teacher, bds. 37 North av.

Van Allen W. Irving, removed to Watkins

Van Almkerk John, laborer, house 10 Pryor

Van Almkerk John jr. varnisher, 184 State, boards 10 Pryor [n. St. Joseph

Van Almkerk Leonard, laborer, h. Huron

Van Alstine Conrad, foreman, Brown corner Jones, house 111 Brown

Van Alstine George A. shoemaker, 87 North Water, h. 68 Joiner [b. 68 Joiner

Van Alstine Linus, shoemaker, 87 N. Water,

Van Anden Charles H. (Campbell & Van Anden), house 4 Huntington

Van Antwerp Elizabeth, widow, h. 19 James

Van Antwerp John, driver, 14 Front, house 293 State

Van Antwerp Minerd, teamster, h. 295 State

Van Auken Edwin B. clergyman, house 210½ East Main

Van Auken Edwin E. removed to New York

Van Auker Edwin L. clerk, b. 78 Atkinson

Van Auker John, hackman, h. 78 Atkinson

Van Auker John W. hackman, 15 Fitzhugh, h. Brown's al. n. Jay [Allen

Van Benthuyssen Charles, boilermaker, h. 16

Van Benthuyssen Mary A. Mrs. boarding house, 16 Allen

Van Bergen Jane, boards 7 Clinton place

Van Bergen Sarah, widow, h. 7 Clinton pl.

Van Bergh Marcus H. salesman, 44 Mill, b. 8 Elm [Elm

Van Bergh Morris, salesman, 36 Mill, h. 8

Van Buskirk Edward E. milkman, house 48 Oakland park [West avenue

Van Buskirk Eliza A. Mrs. house Favor n.

Van Buskirk John, driver, 163 Exchange, b. 61 Prospect [2 Favor

Van Buskirk William, painter, 3 Canal, bds.

Vancamp Emmett, brakeman, N. Y. C. R. R. house 44 Temperance buildings

Vance Arthur, salesman, house 330 State

Vance Ellen, widow, house 141 N. Clinton

Vance Hamilton, deceased, April 6, 1876

Vance John C. sawyer, house 14 Martin

Vance William J. foreman, 73 N. Water, h. 7 Marietta [Main, h. 31 Howell

Van Dake Henry F. boots and shoes, 34 W.

Van Dake James, conductor, N. Y. C. R. R. house 8 Concord avenue

Van Dake L. B. Mrs. house 27 Howell

Van Daman Matthew, packer, 1 W. Main, h. Ninth near Rowe

Vande Abiel, teamster, h. 28 Hamilton place

Van Deben Henry H. cabinetmaker, house 11 Murray [house 57 Court

Van De Bogart George F. clerk, 2 W. Main,

Van De Carr Norman M. clerk, 31 Exchange, boards 24 South avenue

VAN DE CARR REUBEN D. mustard manuf., spices &c. 31 Exchange, house 24 South avenue.—See page 597

HENRY C. WISNER,

**DECORATED CHINA, SILVER SETS,
No. 33 STATE STREET,**

Van De Lende Dennis C. h. 293 St. Joseph
 Van De Lende Dennis C. jr. saloon, 293 St. Joseph, house do. [cinnati, Ohio].
 Van De Lende James C. removed to Cin-
 Van De Mark Cora Mrs. boards 50 Court
 Vandenbergh Abram F. h. 104 University av.
 Vandenbrooke John, teamster, house 114 Jay
 Vanderbeck Andrew A. farmer, h Lake av. near tollgate [av. near tollgate
 Vanderbeck Elizabeth, widow, boards Lake
 Vanderbeck George W. harnessmaker, 98 East Main, house 32 Stillson
 Vanderbeck Susan, widow, boards 19 Elm
 Vanderbilt John A. clerk, 66 West Main, b. 9 Scio
 Vanderbroeke Adriaan, house 138 St. Joseph
 Vanderburgh Frederick A. student, Rochester Theological Seminary, b. Trevor Hall
 Vanderburgh Maria, widow, h. 131 Hudson
 Van Deren David, house 18 Ambrose
 Van Deren David G. plumber, b. 18 Ambrose
 Vanderhave Jennie, gilder, 38 Gorham, bds. 43 Nassau [Nassau
 Vanderhave John M. clockrepairer, house 43
 Vanderhave Marines J. shoemaker, 83 North Water, house 239 St. Joseph
 Vanderhoff Eveline, widow, h. 59 William
 Vanderhoof William, farmer, house Thurston road [h. 3 Leopold
 Van Der Koorde Herbert B. cabinetmaker,
 Van Der Koorde Herbert B. jr. machinist, 7 North Water, boards 3 Leopold
 Vanderpool Rosanna, widow, h. 25 S. St. Paul
 Vanderpool William D. farmer, house Culver near Schanck avenue
 Vandervoort William, oiler, N. Y. C. R. R. depot, house 20 Almira [Borchard
 Vanderwarth Peter, laborer, 44 Front, house
 Vanderwerf John, house 100 Kelly
 Vanderwerf Leonard, carpenter, rear 138 University avenue, house 138 do.
 Vanderwerf Martin, painter, 5 S. St. Paul, house 88 Alexander
 Van Derwheeler Crine, butcher, 44 Front, house Huron near St. Joseph
 Van Deuser Eugene, wood moulder, house 66 Ontario
 Van De Vate Leonard, laborer, house 24 Sherman [bds. 24 Sherman
 Van De Vate Peter, sashmaker, 13 Warehouse,
 Van De Walle Jacob, house 20 Pryor
 Van Dewalle John C. salesman, State corner Platt, house Lake av. n. Ridge road
 Van Dewalle John J. farmer, boards Lake avenue near Ridge road
 Van De Zande John, laborer, paper mill, house 34 Henry [h 105 Allen
 Van Dolah Henry H. foreman, Oak c. Smith,
 Van Dolah Mary, widow, h. 11 Thompson
 Van Dolah Sarah E. widow, b. 53 North av.
 Van Dolah William L. barrel heading, Oak cor. Smith, house 11 Thompson
 Van Dolah William T. deceased Dec. 1875
 Van Doorn Adrian, mason, house 63 Baden
 Van Doorn Dina Miss, bds. 50 East avenue
VAN DOORN FRANK, sign and ornament-
 al painter, 74 Arcade, house 40 Adams.
 —See page 644

Van Doorn John, mason, 44 Tappan, h. do.
 Van Doorn Marienus, rem'd Holland, Mich.
 Van Dusen Conrad, harnessmaker, 103 E. Main, house 53 Asylum [n. Childs
 Van Dusen Curtis, teamster, house Lyell
 Van Dusen Henry J. salesman, 11 Mumford, house 26 Marshall
 Van Dusen Maria L. widow, house 50 Court
 Van Dusen Robert F. switchman, Dean st. crossing, boards 23 Brown
 Van Duzee E. Millard, bookkeeper, 124 Front, boards 16 North Clinton
 Van Dyke Andrew, teacher, b. 15 E. Maple
 Van Dyke Horace G. clerk, 72 West Main, boards 15 East Maple
 Van Dyke John I. cigar manufacturer, 48 Exchange, house 15 East Maple
 Van Epps Abram W. house 135 N. Union
 Van Epps John C. lawyer, 10½ S. St. Paul, h. 55 Goodman n. East avenue
 Van Es Cornelius, laborer, house 23 Edward
 Van Est Mary E. Mrs. 69 State, boards Waverley House [Waverley House
 Van Est Peter W. manager, 69 State, boards
 Van Etten Caroline Stowe, widow, house 93 Lake avenue
 Van Etten James F. deceased 1875
 Van Etten Mary A. widow, h. Lake view pk.
 Van Every Frank, waiter, 36 West Main, b. Ward near North St. Paul
 Van Graafeiland Morris, safemaker, 188 State, house Huron near St. Joseph
 Van Graafeiland Rudolph, blacksmith, 87 Front, house 334 North Clinton
 Van Hees Harmon, bluing manuf. 237 North Clinton, house do.
 Van Heyl Adrian, shoemaker, h. 33 Cypress
 Van Heyl Henry, gardener, boards 33 Cypress
 Van Heyl John, yardman, Ayers' Hotel, boards do. [b. 10 Chestnut
 Van Hoesen Lawson N. clerk, 73 E. Main,
 Van Hoesen Maggie, vestmaker, bds. 8 Bloss
VAN HOESEN SAMUEL C. door and sash manufacturer, 15 Warehouse, house 140 Frank.—See page 579
 Van Hoosen Erastus R. brickmaker, house 29 Jones [bds. 29 Jones
 Van Hoosen Myron C. cutter, 75 N. Water,
 Van Hoosen Willard T. brickmaker, boards 29 Jones [North av.
 Van Houghton Adaline, widow, house 114
 Van Houte Isaac J. carpenter, Brown's alley, bds. 33 Sherman
 Van Houte John, carpenter, Brown's alley, house 33 Sherman
 Van Houte Sarah, deceased June 17, 1875
 Van Houten Erastus L. mason, house 50 Thompson
 Van Houten Hettie, deceased Feb. 1876
 Van Houten John O. shoemaker, 73 N. Water, house 177 North Clinton
 Van Houten Orilla, widow, b. 42 Thompson
 Van Houten James S. rem'd to Chicago, Ill.
 Van Ingen Arie, house 30 Gorham
 Van Ingen Bernard S. receiving teller, Monroec Co. Savings Bank, 31 State, house 15 Hudson
 Van Ingen John A. coal, 4 West av. b. 23 do.

- Van Ingen John V. clergyman, h. 23 West av.
 Van Jura Frank, cigarmaker, 48 Exchange, house 34 Stillson
 Van Keuren Benjamin, house 79 State
 Van Keuren Hannah, widow, bds. 34 Gibbs
 Van Keuren Nancy Mrs. nurse, b. 7 Sophia
 Van Lare David, carpenter, h. 30 Sherman
 Van Leeren Peter, baker, 147 E. Main, house 4 Joiner
 Van Lieu Andrew J. teacher, bds. 45 Court
 Van Loen Amelia, stitcher, bds 45 Andrews
 Van Maaren Cornelia, widow, b. 2-Bismarck place [h. Hudson n. Norton
 Van Maaren Henry, hairdresser, 78½ Hudson,
 Van Maaren Gisbert A. finisher, 107 State, house 248 North St. Paul [55 Kirk
 Van Male John, carrier, Post Office, house
 Van Namee James, bar tender, Waverley House, boards 14 Mathews
 Van Namee Robert M. salesman, 73 E. Main, boards 14 Mathews
 Van Namee Sydney M. house 14 Mathews
 Van Ness Benjamin H. clerk, 78 State, bds. 36 Fitzhugh [hugh
 Van Ness Catharine E. widow, h. 36 Fitz-
 Van Ness Charles G. clerk, 332 State, b. do.
 Van Ness Cornelius V. W. carpenter, house 45 Hudson [Fitzhugh
 Van Ness Filon, salesman, 68 W. Main, b. 34
 Van Ness John (*Simmelink & Van Ness*), 71½ Hudson, boards Hudson near Norton
 Van Ness Mary, telegrapher, Goodman cor. R. R. house 224½ East Main
 Vannier Victor A. E. shoemaker, h. Maria
 Van Olinda Frank E. bookkeeper, 42 Allen, boards 78 Hunter
 Van Olinda Jacob, watchman, Court corner Stone, house 78 Hunter
 Van Ripper Sarah Mrs. house 74 West avenue
 Van Roe Abram, blindmaker, 13 Warehouse
 Van Roe Isaac, laborer, house Hoelifer near St. Joseph [h. 4 Hawkins
 Van Roe Jacob, blindmaker, 15 Warehouse,
 Van Ryne Peter, trunkmaker, foot Rowe, h. 48 Tappan
 Van Schuyver Alvin (*Miller & Van Schuyver*), 147 West Main, boards 18 Pinnacle av.
 Van Schuyver Elmira F. widow, house 18 Pinnacle avenue [Pinnacle av.
 Van Schuyver George J. carpenter, bds. 18
 Van Slack —, painter, b. Centre cor. Mill
 Van Slyck Adell, boards 52 Bolivar
 Van Slyck Adrian W. house 61 West Maple
 Van Slyck Gaylord, carpenter, boards 109 Chatham [W. Maple
 Van Slyck Harman H. brakeman, boards 61
 Van Slyck Julia, boards 52 Bolivar
 Van Slyck Maria A. widow, h. 52 Bolivar
 Van Stallen Peter, carpenter, h. 56 St. Joseph
 Van Styles Jyles, house 44 North Water
 Van Thof Mary, widow, bds. 151 Hudson
 Van Tyne Henry K. bookkeeper, Elizabeth corner Hill, house 14 St. Clair
 Van Tyne James M. coach maker, 3 Canal, house 19 Penn [h. 147 Tremont
 Van Tyne Matthias J. blacksmith, 3 Canal,
 Van Tyne Theodore, wheelmaker, 3 Elizabeth, bds. 14 St. Clair
 Van Valkenburgh Amelia, widow, house 12 Tremont pl.
 Van Valkenburgh Harrison C. conductor, h. 13 Franklin [b. 5 New York
 Van Valkenburgh Henry S. grocer, 54 Platt,
 Van Valkenburgh Jane D. widow, boards 5 New York [York
 Van Valkenburgh Urial, clerk, bds. 5 New
 Van Vechten Frank A. baggageman, boards 21 Hudson [21 Hudson
 Van Vechten George W. clerk, 22 E. Main, b.
 Van Vechten John G. gatetender, N. Y. C. depot, house 21 Hudson
VAN VECHTEN JOHN W. & CO. (T. C. Fletcher), hat manufs. 35 State, house Briggs' place.—*See page 579*
 Van Velsen James M. coachman, 20 Frank, house 41 Weld [Atwater
 Van Velson Morris, patternmaker, house 92
 Van Velthoven Emil, house 6 Scrantom
 Van Vleck John H. physician, h. 17 Spring
 Van Vliet Lawrence, laborer, house 19 James
 Van Vliet Morris, printer, 3 W. Main, house 4 Averell
 Van Vliet William B. printer, 3 West Main, house 89 Monroe av. [Goodman
 Van Voorhis Almira G. widow, b. East av. c.
 Van Voorhis Elvira, widow, house 12 Gardiner park
 Van Voorhis John, lawyer, 77 Powers' bldgs. house East avenue cor. Goodman
 Van Voorhis Menzo (*Eastman & Van Voorhis*), 14 State, boards 9 Troup
 Van Voorhis Quincy, lawyer, 77 Powers' bldgs. house 12 Gardiner park
 Van Vorst David, laborer, 144 East Main, b. 114 North avenue [34 Charlotte
 Van Vorst Edwin, policeman, City Hall, h.
 Van Vorst Gabriel L. passenger agent, Erie railway, 4 State, boards 23 Pearl
 Van Vorst Martha, deceased Feb. 1875
 Van Vranken Clinton, rem'd to Schenectady
 Van Waes Charles, peddler, house 58 Vienna
 Van Wagner Nathan, painter, h. 9 William
 Van Wezel John C. teacher, b. 105 Hudson
 Van Winkle John W. student, 96½ E. Main, boards 84 East avenue
VAN ZANDT BENJAMIN B. tea, coffee, spices, &c. 112 State, house 14 Monroe avenue.—*See opp. page 550*
 Van Zandt Charles E. framemaker, 38 Gorham, boards 36 Andrews
 Van Zandt Clarence D. clerk, 20 West Main, boards 18 North avenue
 Van Zandt George D. tinsmith, Vacuum Oil Works, house 45 Broadway
 Van Zandt Irving W. (*Gordon, Van Zandt & Co.*), 50 Exchange, bds. 155 Alexander
 Van Zandt John P. hairdresser, 88 E. Main, boards 49 St. Joseph
 Van Zandt John J. clerk, 82 West Main, bds. 18 North avenue
 Van Zandt J. J. Mrs. widow, house 18 North avenue
 Van Zandt Llewellyn H. bookkeeper, Roch. Savings Bank, boards 18 North av.
 Van Zandt Margaret, dressmaker, 5 Clinton place, house do.

VAN ZANDT MAXCY N. & CO. (*J. F. Force*), tea, coffee and spice, 11 West Main, h. 155 Alexander.—*See page 573*
 Van Zandt M. Newell, salesman, 11 West Main, house 42 Asylum
 Van Zandt Nelson L. removed to Colorado
 Van Zandt Romeo B. brakeman, N. Y. C. R. R. house 64 North avenue
 Van Zandt Sarah J. Mrs. boards 13 Oak
 Varley Patrick, laborer, Gas Works, boards Wimple House
 Varley Susan, domestic, 45 Frank [change
 Varney Elizabeth J. widow, house 101½ Ex-
 Varney Frank B. clerk, 9 West Main, boards 101½ Exchange
 Varnum Jonas P. lawyer, 58 Powers' bldgs. boards 29 Plymouth avenue
 Vars John A. watchmaker, Court cor. Stone, boards 54 Monroe avenue
 Vary William M. agent, house 6½ Atwater
 Vaughan Caspar, expressman, 83 State, house 21 Spring [Bartlett n. Seward
 Vaughan Charles S. student, 110 State, house
 Vaughan Evan D. deceased Aug. 17, 1875
 Vaughan Marinda A. Miss, dressmaker, 55 E. Main, house do.
 Vaughan Philo B. boards, 15 Gregory
 Vaughan Richard F. machinist, h. 8 Jones av.
 Vaughan Sarah J. widow, house r. 14 Allen
 Vaughan Wallace, car driver, r. 21 Spring
 Vay Edward, dry goods, King c. East Maple, house do. [19 Gibbs
 Vay John, blacksmith, Brown c. Jones, h.
VAY RUDOLPH, secretary Roch. German Insurance Co. W. Main c. Fitzhugh, h. 53 West Maple.—*See page 691*
 Vayo Hattie Miss, house 138 West Main
 Vealey John, car coupler, house Champlain
 Veazie Mindwell, widow, house 15 Mortimer
 Vedder Anna, widow, house 31 Delevan
 Vedder Frank W. boards 31 Delevan
 Vedder F. A. Mrs. house 28 Andrews
 Vedder Henry C. boards 13 John
 Vedder John S. boards 31 Delevan
 Vedder J. S. Mrs. boards 4 Goodman
 Vedder Meander W. book agent, h. 13 John
 Veeder Edwin C. photographer, 45 E. Main, house do. [State
 Vegiard Antoine, cutter, 70 Mill, house 79
 Vegiard J. Charles, shoecutter, b. 11 Marshall
 Veit E. George, brewer, 139 N. St. Paul, house 121 do.
 Veith George M. salesman, 26 East Main, h. 224 North Clinton
 Veith John M. carpenter, house 24 Wilson
 Velkle Anthony, brewer, h. 225 N. St. Paul
 Vette Philip, butcher, 104 W. Main, house. 1 Nassau
 Vercus Elizabeth Mrs. boards Vernon park
 Vercus Henry, engineer, 141 N. Water, h. 25 Catharine
 Verduyn Sarah, domestic, boards 65 East av.
 Verherbrugge Josiah, peddler, h. St. Joseph near Norton
 Verherbrugge Maria, widow, bds. St. Joseph near Norton [Paul, b. 223 do.
 Verhoeven Anthony, blacksmith, 225 N. St.
 Verhoeven Antoinette, bds. 223 N. St. Paul

Verhoeven August, blacksmith, 225 N. St. Paul, house 223 do. [Joiner
 Verhoeven Henry, painter, 3 Canal, h. 12
 Verhoeven John, clerk, 36 Mill, house 19 St. Joseph [ander
 Verhoeven Michael, engineer, h. 98 Alex-
 Verhoeven Michael A. grocer, 30 S. St. Paul, house 104 Broadway
 Verhoeven William, machinist, h. 29 Gorham
 Verhoeven William, mason, h. 86 Broadway
 Verian John, laborer, house 110 Adams
 Verian Mary Mrs. house 24 West avenue
 Verian Richard, moulder, 150 N. Water, b. 110 Adams
 Verian William, packer, 9 Platt, b. 110 Adams
 Verley Michael, laborer, house 2 Bolivar
 Vernam James B. clerk, 68 West Main, bds. 5 Franklin square
 Vernam Mary J. Mrs. b. 2 Livingston place
 Verner Carl, gunsmith, house 11 Hawkins
 Verner Frederick, mason, boards 95 Meigs
 Verner James E. blacksmith, boards West alley near Spring
 Verner Tamson, widow, boards Tremont c. Reynolds
 Versprelle Edwin, deceased June, 1875
 Versprelle Henry, laborer, h. Berlin n. Hudson
 Versprelle Isaac, laborer, 48 Front, house Henry c. Vose
 Versprelle John, laborer, house 10 Vose
 Versprelle John jr. shoemaker, b. 151 Hudson
 Vessey Charles, removed to England
VETTER AUGUST & CO. (*G. Bock*), cabinetmakers, 149 North Water, house 76 Joiner.—*See page 620*
 Vetter Charles L. filer, house 3 Pryor
 Vetter Christiana, widow, house Ulm n. Bay
 Vetter Frederick, clerk, 39 State, house 1 Elizabeth place
 Vetter Gottlieb, cutter, boards 197 Scio
 Vetter John G. cutter, 36 Mill, b. 197 Scio
 Vetter Joseph W. cutter, house 197 Scio
 Vetter Valentine, carpenter, house 197 Scio
 Veyhl Henry E. (*Veyhl & Bartholomew*), h. 334 State
VEYHL & BARTHOLOMEW (*H. E. Veyhl and F. Bartholomew*), furniture and upholstery, 9 Front.—*See page 622*
 Vianco Geo. W. machinist, Brown c. Jones, boards 32 Saratoga avenue
 Vianco William J. deceased Oct. 1875
 Vicinus Christian, laborer, bds. 4 Philander
 Vicinus Henry, laborer, house 4 Philander
 Vicinus Magdalen, widow, bds. 4 Philander
 Vicinus William (*Whitmore, Rauber & Vicinus*), house 16 North avenue
 Vick Charles F. printer, 62 State, h. 104 Jay
 Vick Charles J. shoecutter, 55 Mill, house 120 Champlain [Howell
 Vick Edward H. clerk, 62 State, house 25
 Vick Frank H. cashier, 60 State, house 23 Vick park
 Vick George, lampmaker, house 10 Clifton
 Vick George A. machinist, bds. 10 Clifton
VICK JAMES, seedsman and florist, 62 State cor. Market, house East av. near Vick park.—*See page 533*
 Vick James jr. 62 State, house 18 Vick park

- Vick Joseph S. shoecutter, 55 Mill, boards
120 Champlain
- Vick William, florist, house 28 Vick park
- Vick Wm. H. clerk, 62 State, b. 28 Vick pk.
- Vickerman John, painter, h. 166 Champlain
- Vickery Abraham, agent, Rochester Cotton
Mills, foot Centre, house 34 Sophia
- Vickery Charles A. bookkeeper, Rochester
Cotton Mills, boards 34 Sophia
- Vickroy John P. laborer, h. 2 Saratoga av.
- Viehman John, cutter, 36 Mill, h. 26 Lowell
- Viehman John jr. clerk, boards 26 Lowell
- Viele Platt B. sec'y and treas. East Side Sav-
ings Bank, 127 E. Main, and (*Chase,*
Bristol & Viele), boards 6 Elm
- Viele Platt C. house 6 Elm
- Viergever Jacob, trimmer, b Clifford near
St. Joseph [Joseph
- Viergever Peter, painter, h. Clifford near St-
Viergever Daniel, deceased January, 1876
- Viergever Jenny Miss, house Pine n. Troup
- Viergever John, carpenter, Minerva alley, b.
Pine al. c. Troup
- Viergever Nellie, widow, h. 127 Hudson
- Vierow Frederick, laborer, house 13 Morris
- Villnow Chas. tailor, h. 30 German
- Vincent Chauncey, laborer, h. 15 Goodman
- Vincent Chauncey J. servant Osburn House,
boards 18 Erie [b. do.
- Vincent Edward B. clerk, Chapman House,
- Vincent Edwin B. bookkeeper, house 11
Matthews
- Vincent John, waiter, house 72 Manhattan
- Vincent John P. patterns, 10 South Clinton,
house do. [c. Clifford
- Vincent Mary Sister, Notre Dame, Hudson
- Vincent Mary, Sister of Mercy, 5 South
- Vinton Edward, saloon, 57 Spring, h. do.
- Virgo Sidney D. ticket agent, N. Y. C. R.
R. depot, house 45 Jones avenue
- Vitues Martin, tailor, 149 St. Joseph, bds.
109 Chatham
- Voelker Fred. W. machinist, 129 Mill, bds.
12 Almira [12 Almira
- Voelker Henry, machinist, 129 Mill, house
- Voelkel Anthony, maltster, 139 N. St. Paul,
house 225 do.
- Voelkl Christian, shoemaker, 87 E. Main, h.
97 Wilder [105 West Maple
- Voelkl Geo. shoemaker, 87 E. Main, house
- Voelkl Joseph, grocer, Ames c. W. Maple,
house do. [near Colvin
- Voelkl Thravis, widow, house West Maple
- Voets John, laborer, Brown's Race n. Fur-
nace, house 53 Lime [170½ do.
- Vogel Adam, market, 163 West Main, bds.
- Vogel August, laborer, house 28 Hand
- Vogel Barbara, widow, house 24 N. Frances
- Vogel Charles, tinsmith, 90 East Main, house
53 Andrews
- Vogel Fred. painter, 5 S. St. Paul, h. at Gates
- Vogel Johanna, widow, h. Joiner c. Atwater
- Vogel John, laborer, house 116 W. Maple
- Vogel John, cabinet maker, 14 St. Joseph,
house 125 North Clinton
- Vogel John W. glassblower, h. 26 Champlain
- Vogel John O. tinsmith, 90 E. Main, house
75 S. Union
- Vogel Joseph, cigar maker, h. 69 W. Maple
- Vogel Leonard, carpenter, h. Channing near
Concord avenue
- Vogel Leonard, sash maker, Aqueduct, h.
138 North Clinton [Atwater
- Vogel Louis, upholsterer, 73 State, bds. 41
- Vogel Louisa Miss, boards 35 Ontario
- Vogel Minnie, milliner, 129 E. Main, bds. 41
Atwater
- Vogel Peter, baker, Maple c. Brown, boards
24 North Frances [130 Frank
- Vogel Theodore J. printer, 3 West Main, h.
- Vogel Vincent C. agent, house 30 Sellinger
- Vogel Wilhelmina (*Vogel & Mueller*), house
3 Marietta [grocers, 40 Front
- Vogel & Mueller (*W. Vogel and H. Mueller*),
Vogle Michael, cigar maker, 48 Exchange,
house 191 Brown
- Vogler Hilarius, carpenter, house 45 Sherman
- Vogler John, carpenter, house Langham n.
St. Joseph
- Vogler Wendeline, tailor, house 31 Lowell
- VOGT ALBRECHT**, dress and upholstery
trimmings, 44 Exchange, house 195 N.
Clinton.—*See page 645*
- Vogt Anthony, cabinet maker, 2 Hill, boards
24 Caroline [William
- Vogt Balthazer, clerk, 54 S. St. Paul, h. 195
- Vogt Catharine, widow, h. 170 Pinnacle av.
- Vogt Constantine, mason, house 42 Caroline
- Vogt Frederick Mrs. flour, &c., 62 Front,
house do.
- Vogt Frederick, house 62 Front
- Vogt Henry, driver, 93 State, house Jay near
city line [n. Norton
- Vogt Jacob, bone charcoal, house N. Clinton
- Vogt John, tailor, b. North av. n. Stewart
- Vogt Joseph F. butcher, bds. 29 Broadway
- Vogt Joseph L. marble cutter, 122 South St.
Paul, house 49 Savannah
- Vogt Martin, tailor, h. North av. n. Stewart
- Vogt Martin, harness maker, 153 North av.
house do.
- Vogt Peter, hairdresser, 108 East av. h. do.
- Vogt Peter, butcher, bds. 58 S. St. Paul
- Vogt Sophia, widow, boards 13 Maria
- Vogt Thomas, brickmaker, h. 29 Broadway
- Vohs Frederick, laborer, house 5 North York
- Vohs William, machinist, h. 72 W. Maple
- Voith George J. butcher, 42 Front, house 75
King [37 Franklin
- Voke George M. printer, 23 W. Main, boards
- Volk Anton, machinist, Brown cor. Jones,
house 48 Lime
- Volk Jacob, tailor, house 2 Hollister
- Volk Philip, varnisher, 184 State, h. 11 Baden
- Volker Henry, machinist, h. 12 Almira
- Volkert Henry, spinner, h. 91 N. Clinton
- Volkert Michael, saloon, 9 South av. h. do.
- Valkhausen August, local editor, Rochester
Beobachter, 25 W. Main, h. 160 North
Clinton
- Voll Joseph, glass blower, house 93 Reynolds
- Vollertsen Conrad, gardener, Frost av. c.
Olean, bds. 3 Olean
- Vollertsen Marquard, tailor, h. 3 Olean
- Vollertsen Peter, gardener, Frost av. c. Olean,
boards 3 Olean

Vollmer John, carpenter, h. 4 Oakland park
 Voltz Frederick, boards 115 Broadway
 Voltz Frederick J. butcher, 132 East Main,
 boards 1 Amity [115 Broadway
 Voltz Joseph F. foreman, 27 E. Main, bds.
 Voltz Valentine, removed to Buffalo
 Von Deben Frederick, cabinetmaker, Jay c.
 canal, boards 57 Whitney
 Von Deben Henry H. cabinetmaker, Jay cor.
 Erie canal, house Murray near Jay
 Von Deben Joachim, cabinetmaker, Jay cor.
 Erie canal, house 57 Whitney
 Vonhold John, mason, house Allmeroth near
 Henrietta avenue
 Vonhuben John, laborer, house 7 Zimmer
 Voorhees Gilbert, boards 22 Gardiner park
 Vorberg Emily, widow, house 13 Chestnut
 Vorhees John, clerk, 81 E. Main, house 130
 Alexander [Alexander
 Vorhees J. Mrs. milliner, 81 E. Main, h. 130
 Vormeng Henry, clerk, 164 W. Main, house
 460 Brown [East Main
 Vormeng William, clerk, 42 State, bds. 103½
 Vorndran Anna, forewoman, 44 Exchange,
 boards 11 Morris
 Vosburgh Egbert B. removed from city
 Vosburgh Henry P. tinsmith, Saxton near
 West Maple, house do.
 Vosburgh John L. agent, 61 State, b. 16 King
 Vosburgh John R. private school, East Main,
 cor. Stone, house 79 Broadway
 Vosburgh Mary C. widow, house 16 King
 Vosburgh Reuben, removed from city
 Vosburgh Sarah J. drawing teacher, boards
 16 King [house 7 King
 Vosburgh William J. dry goods, 86 West av.
 Vosburgh William R. student, University of
 Rochester, boards 27 Howell
 Vose Frederick, insurance agent, 52 Arcade,
 house 38 Concord avenue
 Vose Frederick, laborer, rear Exchange n.
 Court, house 5 York
 Voshall Charles W. bookkeeper, 14 St. Jo-
 seph, boards 53 Atwater
 Vosper Mary E. widow, boards 20 Oregon
 Voss Charles, teamster, 139 North St. Paul,
 house 22 Hoeltzer
 Vosseler John, carpenter, house 11 Rhine
 Vredenburgh Edward H. cashier, Powers'
 Banking House, West Main cor. State,
 house 93 Fitzhugh
 Vredenburgh, see Fredenburgh
 Vreeland Frank D. student, University of
 Rochester, boards 80 Court
 Vreeland John W. salesman, 81 N. Water,
 boards N. St. Paul cor. Mortimer
 Vroman Henry C. (*Vroman & Young*), house
 8 Ontario
VROMAN & YOUNG (*H. C. Vroman and
 H. Young*), building movers, 8 Ontario
 and 95 Weld.—*See page 651*
 Vrooman Cornelius, laborer, bds. 8 Ontario
 Vyverberg John C. painter, 5 S. St. Paul, b.
 Clifford near Hudson [Hudson
 Vyverberg Joseph, laborer, house Clifford n.

WABNITZ WILLIAM, butcher, house 34 Strong
 Wackerla Charles F. tailor, house 24 Ontario

Wackerman Claria, widow, house 29 Childs
 Wackerman Frank X. machinist, Brown c.
 Jones, h. 22 King [boards do.
 Wackerman Geo. W. hairworker, 90 State,
 Wackerman John, deceased Sept. 8, 1875
 Wackerman John P. farmer, bds. 29 Childs
WACKERMAN MICHAEL, wig maker
 and hairdresser, 90 State, house do.—
See page 515
 Waddel George, gardener, house 15 Sanford
 Waddell Anthony, varnisher, Jay cor. canal,
 boards 169 Jay [canal, h. 10 Kondolf
 Waddell Frank, wood moulder, Jay c. Erie
 Waddell Philip J. grinder, 8 Hill, b. 87 Jay
 Waddell Valentine, fireman, h. 254 Brown
 Wade Charles, machinist, 10 S. Water, bds.
 78 S. St. Paul
 Wade Mary J. widow, house 2 Orange
 Wade Susan M. seamstress, boards 2 Orange
 Wade Warren W. engineer, h. 28½ Comfort
 Wade William, carpenter, 40 Fulton avenue,
 house 16 Ambrose [Jay
 Wadel Harry, miller, Ely Mills, boards 169
 Wadel Joseph, watchman, house 169 Jay
 Wadick James, laborer, house 31 Romeyn
 Wadick James, clerk, boards 85 Mill
 Wadick Thomas, laborer, Charlotte junction,
 boards 31 Romeyn
 Wadick Wm. H. switchman, bds. 31 Romeyn
 Wadington Mary Ann, widow, house 47 Pin-
 nacle avenue
 Wadsworth Caroline, widow, boards 22 Jones
 Wadsworth Whiting, manufacturer stove
 boards, boards 77 Lake avenue
 Waffle Andrew, clerk, 70 West av. boards 17
 West Troup [West Troup
 Waffle Charles, teamster, 30 West av. h. 17
 Waffle Charles jr. pottery, 151 West avenue,
 bds. 17 West Troup [Vose n. Hudson
 Wagemaker Abraham, tailor, 17 Front, house
 Wagenbreth Wm. cigarmaker, 3 Eagle, bds.
 191 North Clinton
 Wager Eliza J. Miss, house 88 Tappan
 Wager John (*Wager & Renner*), 2 N. St. Paul,
 house 22 Stone [136 Scio
 Wager Miles, blacksmith, 249 East Main, h.
 Wager William M. blacksmith, 249 E. Main,
 house 136 Scio
 Wager & Renner (*J. Wager and C. D. Renner*),
 hairdressers, 2 N. St. Paul
 Wagner Adam D. teamster, h. 165 W. Main
 Wagner Adolphus, shoemaker, 73 N. Water,
 house 12 Terry [b. 188 N. Clinton
 Wagner Albert, watchmaker, 179 N. St. Paul,
 Wagner Anna Miss, boards 55 Scio
 Wagner August, laborer, house Lincoln cor.
 Clifford [Delevan
 Wagner Augustus, cabinetmaker, house 60
 Wagner Barbara, widow, house 88 Jay
 Wagner Caroline Mrs. milliner, 70 Hudson,
 house do.
 Wagner Caroline, widow, house 67 Gregory
 Wagner Charles, shoemaker, 73 North Water,
 boards 12 Terry
 Wagner Charles, laborer, house 33 Mark
 Wagner Charles, cigarmaker, bds. 232 State
 Wagner Charles J. F. tailor, 10 West Main,
 house 58 West Maple

A. R. PRITCHARD & LIKLY,

STEAMER TRUNKS--SOMETHING NEW,
 No. 78 STATE STREET.

- Wagner Christian, tailor, house 50 Weld
 Wagner Daniel, artist, 95 Arcade, house do.
 Wagner Edward G. saloon, 12 North Clinton, house do.
 Wagner Eliza, widow, h. Pennsylvania av.
 Wagner Francis, blacksmith, 3 Canal, house 88 West avenue [58 W. Maple
 Wagner Frank C. hairdresser, 127 State, bds.
 Wagner Frederick, clerk, boards 88 Jay
 Wagner Frederick, shoemaker, 15 Mill, house 9 Vienna [house do.
 Wagner Frederic, baker, Jay corner Childs,
 Wagner Frederick W. carpenter, boards 59 Asylum [19 Almira
 Wagner Frederick W. carver, 184 State, h.
 Wagner George, shoemaker, 83 N. Water, house 26 Buchan park
 Wagner George, mason, house 52 N. Union
 Wagner George J. carpenter, bds. 16 Leopold
 Wagner Henry, deceased January, 1876
 Wagner Henry C. hairdresser, 3 Mill, bds. 58 West Maple [avenue
 Wagner Jacob H. carpenter, house Fourth
 Wagner Jacob M. jr. carpenter, 14 St. Joseph, boards 16 Leopold
 Wagner John, grocer, 88 Jay, b. do. [Bartlett
 Wagner John, blacksmith, 3 Canal, h. 180
 Wagner John E. painter, 3 Canal, house 88 West avenue
WAGNER JOHN G. carpenter and builder, 14 St. Joseph, house 53 Atwater.—See page 632 [boards 16 Leopold
 Wagner John G. carpenter, 14 St. Joseph,
 Wagner Joseph, agent, house 45 Kent
 Wagner Joseph jr. shoemaker, bds. 45 Kent
 Wagner Josiah, removed to Dewitt
 Wagner J. Geo. saloon, Hill cor. Ford, h. do.
 Wagner J. George, clerk, 70 State, boards Hill corner N. Ford
 Wagner Kate, domestic, boards 25½ Scio
 Wagner Lena, widow, house N. Clinton near Norton
 Wagner Lina, domestic, boards 18 Vick pk.
 Wagner Louis, sashmaker, foot of N. Water, boards 23 Asylum
 Wagner Lucy Miss, house 1 Cedar
 Wagner Margaret Mrs. house 37 Kent [do.
 Wagner Maria L. Miss, artist, 95 Arcade, h.
 Wagner Monika, widow, house 13 German
 Wagner Peter, carpenter, 59 Asylum, house 23 do.
WAGNER PETER & W. agents, carpenters, 59 Asylum, h. 23 do.—See page 636
 Wagner Philip, upholsterer, bds. 23 Asylum
 Wagner Sister Mary, St. Boniface's School, boards 3 Grand
 Wagner Susan, widow, house 14 Stillson
 Wagner William (P. & W. Wagner), house 59 Asylum [pot, h. 45 Wilder
 Wagner William, car inspector, N. Y. C. de-
 Wagner W. H. insurance agent, b. 52 Pearl
 Wagoner Silas J. agent for city's wood and coal, 28 Hill, house 9 Briggs' place
 Wagstaff Alfred J. student, 90 West Main, boards 73 East avenue
 Wagstaff James, carpenter, rear 73 East av. house 73 do.
 Wah Hong (Wah Lee & Co.), 176 State, h. do.
- Wahl Frank, cutter, 10 Mill, h. Clifford near North Clinton
 Wahl Frank 2d, shoemaker, 77 N. Water, house 2 Buchan park [9 do.
 Wahl Frank J. pattern fitter, 8 Hill, boards
 Wahl Frederick, laborer, 56 Pinnacle av. h. Alexander n. Broadway [n. N. Clinton
 Wahl Jacob N. clerk, 150 State, b. Clifford
 Wahl John, laborer, house 126 South avenue
 Wahl John, laborer, h. 56 Sanford [chan pk.
 Wahl Martin, shoemaker, 15 Mill, h. 8 Buchan
 Wahl Michael, grocer, 34 Herman, house do.
 Wahle Gregory, tailor, house 35 Grape
 Wahle William, tailor, Orange cor. Walnut, boards 35 Grape [Atkinson
 Wait Calvin, clerk, Post Office, house 33
 Wait E. Irving D. (Robins & Waite), Aqueduct near canal, house 60 William
 Wait George, conductor, N. Y. C. R. R. h. 17 Kent
 Wait George D. deceased Nov. 3, 1875
 Wait Henry, laborer, boards 9 North Ford
 Wait Israel C. grocer, 17 Jones, bds. 9 Dean
 Wait Jennie Mrs. nurse, 9 Jay, house do.
 Wait Robert H. bookkeeper, 91 State, bds. 17 Kent [Channing n. North
 Wait Truman, laborer, 56 Hudson, house
 Wait Vercilla, widow, house 9 North Ford
 Wait William, teamster, house Summer near Genesee [canal, h. 62 William
 Wait William, sashmaker, Aqueduct near Wait, see Wayte
 Wake Chas. nurseryman, house 35 Cypress
 Wake Solomon, gardener, h. 53 Charlotte
 Wake William J. shoemaker, 75 N. Water, boards 35 Cypress [South Clinton
 Wakefield Wm. R. master mariner, house 4
 Wakelee Abner, house 60 Plymouth avenue
 Wakelee Samuel P. clerk, 62 State, house 22 Vick park
 Walbridge Eunice, widow, b. 101 Fitzhugh
 Walbridge George W. (Walbridge & Maxwell), State cor. R. R. avenue, boards do.
 Walbridge Silas D. house 318 State
 Walbridge & Maxwell (G. W. Walbridge and J. A. Maxwell), proprs. Waverly House, Railroad avenue cor. State [house do.
 Walbrun Joseph, market, 86 West Maple,
 Waldeis Frank V. shoemaker, 30 East Main, house 92½ South avenue [103 Jay
 Waldele Andrew C. clerk, 53 E. Main, house
 Waldele Catharine Mrs. grocer, 87 Jay, h. do.
 Waldele John E. cooper, boards 87 Jay
WALDER AMOS, pattern and model maker, 130 Mill, house 63 Oak.—See page 675 [do.
 Walder Gottlieb, brewer, 111 N. St. Paul, h.
 Waldert Alois G. (W. and A. Waldert), 3 South avenue, bds. 77 do.
 Waldert Lawrence, grocer, 77 South av. house do.
 Waldert William & A. cigar manufs. 3 South avenue, boards 77 do.
 Waldron James Mrs. b. Jennings n. Goodman
 Waldron John, laborer, Erie Ry freight depot, house Seward cor. Cady [Hospital
 Waldron Winne, widow, boards St. Mary's
 Waldvogel Christian, cooper, h. 53 Kirk

Wales Albert W. trimmer, Andrews cor. N. Water, house 5½ Franklin square
 Waleson Gerard A. sign painter, E. Main c. East avenue, house 97½ South avenue
 Walker Albert C. clerk, 12 State, b. 19 East
 Walker Albert E. clerk, 4 Arcade, h. 19 East
 Walker Angelina B. widow, house 102 Jones
 Walker Anna, widow, boards 16 Troup
 Walker Christian H. peddler, h. 29 Buchan pk.
 Walker Dannie S. clerk, 8 S. St. Paul, bds. 8 South Clinton
 Walker David, laborer, house 58 Adams
 Walker Edward, jeweler boards, 36 Adams
 Walker Eliza, widow, h. 36 University av.
 Walker Eliza Miss, seamstress, house 25 Stillson
 Walker Fidelia, boards 102 Jones
 Walker Frank, shoemaker, h. N. Clinton n. Blumenthal
 Walker Franklin C. lawyer, 158 Powers' bldgs. boards 8 South Clinton
 Walker Frederick R. stoves, &c., 8 South St. Paul, boards 8 South Clinton
 Walker Henry, laborer, 264 N. St. Paul, b. do.
 Walker Hettie, widow, boards 37 Court
 Walker Horatio, photographer, 58 State, b. Clinton Hotel [Genesee
 Walker James, butcher, bds. Bismarc near
 Walker James, shoemaker, 73 N. Water, h. 31 Kirk [E. Main, b. 170½ W. Main
 Walker James F. (*Lindgren & Walker*), 28½
 Walker John, butcher, house Bismarc
 Walker Louisa, boards rear 22 Stillson
 Walker Marcia, sewer, b. 146 South St. Paul
 Walker Orlando, butcher, house 155 Hunter
 Walker Robert C. machinist, bds. 102 Jones
 Walker Rosy, carpetweaver, b. 44 Sherman
 Walker Samuel, butcher, h. Hume n. Genesee
 Walker William, carpenter, h. Ninth n. canal
 Walker William, house 8 South Clinton
 Walker William C. draughtsman, 95 Powers' bldgs. boards 19 East [William
 Walker William H. cigar manuf. house 81
 Walker William H. M. engineer, Erie Railway, house 30 North avenue
 Walker William R. h. York cor. Champlain
 Wall Ann, widow, house 91 Lyell
 Wall Benjamin, helper, boards 23 Tyler
 Wall Bridget, dressmaker, b. Walnut n. Jay
 Wall Catharine, widow, house 14 Gregory
 Wall Chas. W. special dep. collector, Custom House, 31 State, b. 4 North Washington
 Wall Edward, tallyman, Platt c. Kent, h. Walnut near Jay [house 23 Tyler
 Wall Edward, wireworker, 146 East Main,
 Wall Hugh, cooper, boards 91 Lyell
 Wall James, deceased December 19, 1875
 Wall Margaret, widow, bds. Walnut n. Jay
 Wall Michael, deceased December, 1875
 Wall William H. foreman, 8 West av. h. 26 Favor [Monroe avenue
 Walls Robert, cigarmaker, 147 E. Main, bds.
 Wallace Daniel, saloon, 88 Exchange, h. do.
 Wallace Edward J. removed to Oshawa, Ont.
 Wallace Eliza J. teacher, Atwater school, No. 10, boards 126 North St. Paul
 Wallace George A. physician, 18 N. Clinton, boards do.

Wallace Hannah, widow, house 17 Catharine
 Wallace Harriet E. widow, h. 16 Briggs' blk.
 Wallace Jennie, dressmaker, bds. 81 Bolivar
 Wallace John, toolmaker, house 412 Brown
 Wallace John A. grocer, 6 Lake av. h. do.
 Wallace John D. salesman, 53 E. Main, bds. 126 North St. Paul [5 Jay
 Wallace John H. clerk, 14 Exchange, bds.
 Wallace J. U. Mrs. matron, Home for the Friendless, East avenue cor. Alexander
 Wallace Margaret, widow, boards 79 Magne
 Wallace Moses, clergyman, h. 25 N. Frances
 Wallace Robert, watchman, Erie R'y freight house, house 94 Jay
 Wallace Samuel, market, 39 Orchard, h. do.
 Wallace Thomas, toolmaker, bds. 412 Brown
 Wallace Thomas, porter, Brackett House, h. 81 Bolivar [Jones, boards 94 Jay
 Wallace Thomas W. brass moulder, Platt n.
 Wallace Timothy, house 18 North Clinton
 Wallace William, house 126 North St. Paul
 Wallace William, foreman, 10 Mill, house 5 Clifton
 Wallace William L. 3 W. Main, bds. 21 S. Clinton
WALLDORF LOUIS, watches, jewelry, silverware, &c. 54 East Main, house 42 Andrews.—*See page 514*
 Wallenthelm Charles, laborer, h. 52 Sanford
 Waller Ann, boards 41 St. Joseph
 Wallis Edward, veterinarian, h. 50 Alexander [Stone, h. 61 Hamilton place
 Wallis Edward jr. machinist, Court corner
 Walls John E. cigarmaker, 226 W. Main, b. 39½ Monroe avenue
 Walls Thomas H. house 39½ Monroe avenue
 Walls Thomas H. jr. shoemaker, 81 North Water, house 16 University avenue
 Walls William, slater, b. 31 South St. Paul
 Walls W. Robert, cigarmaker, 147 E. Main, boards 39½ Monroe avenue
 Walsh Andrew, laborer, house 13 West
 Walsh Catharine, widow, h. 55 Hamilton pl.
 Walsh Edward, removed to Fairport
 Walsh Eugene, fireman, N. Y. C. R. R. h. 52 Nassau [Mt. Hope avenue
 Walsh John (*Walsh, Westcott & Co.*), bds. 83
 Walsh John D. 9 Gould's building, house 9 Trowbridge [32 Delevan
 Walsh John W. tinsmith, 48 E. Main, house
 Walsh J. William, carriage trimmer, bds. 45 Bartlett
 Walsh Margaret A. packer, boards 13 West
 Walsh Mary, waiter, Whitcomb House, h. do.
 Walsh Patrick R. tool forger, house 38 Weld
 Walsh Samuel, blacksmith, 6 Plymouth av. boards 10 South Ford
 Walsh Sarah J. Miss, clerk, bds. 45 Bartlett
 Walsh Warren W. rector, Trinity Church, boards Brackett House
 Walsh, Westcott & Co. (*J. Walsh, W. Westcott and C. G. Houston*), plumbers, 196 State [45 Bartlett
 Walsh William, agent, 18 West Main, house
 Walt Mary, widow, boards 283 North
 Walter Amos, dry goods, 131 North av. h. do.
 Walter Anthony, grocer, 231 North, h. do.
 Walter Catharine, widow, house 70 Frances

A. R. PRITCHARD & LIKLY,

SHAWL STRAPS,
No. 78 STATE STREET.

Walter Christian, mason, h. Caroline near Goodman [151 Hudson
 Walter Frank W. machinist, 3 W. Main, h.
 Walter Frederick, teamster, bds. 70 Frances
 Walter Geo. laborer, 109 Mill, h. 34 Frost av.
 Walter Hannah D. dressmaker, house 4 Evergreen
 Walter Henry, boards 13 Lowell
 Walter Jacob, removed to Morris, Wis.
 Walter James P. photographer, 55 E. Main, house 301 North Clinton
 Walter Jesse D. (*L. D. and J. S. Walter*), h. 148 Jones
 Walter John (*Walter & Refior*), 16 W. Main, boards 151½ North avenue
 Walter John A. P. stoves, 100 Hudson, h. do.
 Walter John J. machinist, 124 Mill, house 35 Lowell [74 Atwater
 Walter Joseph, carpenter, 93 Exchange, h.
 Walter Lorenzo D. & J. S. dentists, 33 Smith's block, h. 53 Caledonia avenue
 Walter Margaret, widow, boards 12 Delevan
 Walter Nicholas, laborer, house Hollister c. Landing
 Walter Peter, laborer, house 4 Galusha
 Walter Philip, teamster, boards 70 Frances
 Walter William, polisher, Court c. Stone, h. 9 Webster [tailors, 18 W. Main
 Walter & Refior (*J. Walter and S. Refior*),
 Walter, see Wolter
 Walters Catharine, widow, boards 227 North
 Walters George, lather, bds. 4 Plymouth av.
 Walters Michael, freight dispatcher, N. Y. C. R. R. house 227 North
 Walters William (*Walters & Davis*), 1 Smith's block, house 23 Stone [opp. Wilder
 Walters William G. carpenter, boards Colvin
 Walters & Davis (*W. Walters and C. S. Davis*), merchant tailors, 1 Smith's block
 Walther Caroline Mrs. midwife, h. 5 Langham
 Walther Ernst, carpenter, h. 159 North av.
 Walther Henry, millwright, house 56 Baden
 Walther John H. laborer, house 5 Langham
 Walther Philip, carpenter, h. 159 North av.
 Walton John, artist, 62 State
 Walton Mary, stitcher, bds. 169 East Main
 Walz Ambrose, stonecutter, house 7 Vose
 Walz Frank, shoemaker, 79 N. Water, bds. Hudson corner Clifford
 Walz Herman, laborer, h. Emerson n. R. R.
 Walz John, potter, 31 Weld, house do.
 Walz John Mrs. house 31 Ontario
 Walz Mary, widow, house 8 First avenue
 Walz Tobias, stonecutter, h. 10 West avenue
 Walzer John D. teamster, h. Sibley n. Culver
 Wambach Matthew, farmer, h. Hoyt n. Ulm
 Wambach Ann, widow, bds. Bay near Ulm
 Wambach Mary, widow, house Bay n. Ulm
 Wambeck Jacob, removed to Chicago, Ill.
 Wamp Christopher, teamster, 163 Exchange, h. 22½ Scramton
 Wamsley Anna, confectionery, 100 W. Main, house 15 Stone [15 Stone
 Wamsley James, clerk, 100 West Main, h.
 Wamsley John, boards 48 Goodman
 Wamsley Joseph, student, University of Rochester, boards 36 Fitzhugh
 Wamsley Thomas, house 48 Goodman

Wamsley William H. student, University of Rochester, boards 48 Goodman
 Wamsley see Walmsley
 Wandell Alonzo, agent, b. 68 South St. Paul
 Wander Ferdinand, laborer, h. 21 Caroline
 Wander Philip, tailor, 49 Front, b. 8 Wilder
 Wandergerm H. finisher, 22 South St. Paul
 Wandersee Ferdinand, laborer, h. 57 Herman
 Wandersee Ferdinand, laborer, b. 4 Widman
 Wandersee Henry A. laborer, b. 4 Widman
 Wandersee Henry L. laborer, b. 4 Widman
 Wandersee Martin, laborer, b. 4 Widman
 Wandtke Charles, laborer, Vacuum Oil Works
 Wandtke Henry, bricklayer, b. 109 Chatham
 Wangman Caspar, laborer, house 22 Hebard
 Wangman Frederick, carpenter, b. 22 Hebard
 Wangman John, policeman, City Hall, h. 35 Buchan park [house 13½ Herman
 Wangman Joseph, lastmaker, 81 N. Water,
 Wanmaker Frank F. stable, r. 118 W. Main, house 132 Frank
 Wannemaher Frederick, cabinetmaker, 14 St. Joseph, b. 94 North Clinton
 Wanner Louis P. painter, boards 63 Magne
 Wanner Rosanna, widow, house 63 Magne
WANZER GEORGE G. dentist, 16 West Main, house 10 Reynolds.—*See page 588*
 Wanzer Hustid C. deceased, May 11, 1876
 Wanzer Hustid C. Mrs. widow, h. 33 Madison
 Ward Albert, machinist, 20 E. Main, house 13 Fitzhugh
 Ward Alexander, blacksmith, h. 12 Linden
 Ward Annie F. Mrs. house 26 Asylum
 Ward Burnett, laborer, house 77 South av.
 Ward Caroline, grocer, Adams c. Prospect, house do.
 Ward Catharine, widow, house 73 William
 Ward Edward, grainer, 14 Stone, house Goodman n. Monroe avenue
 Ward Frank A. insurance, 4 Exchange pl. h. Grove place
 Ward Frank R. tobacconist, 113 State, b. do.
 Ward George B. cattle broker, h. 106½ West Main [ester, house 2 College av.
 Ward Henry A. professor, University of Rochester
 Ward Henry M. house 2 College avenue
 Ward Herbert L. student, 74 Powers' bldgs. boards Grove place
 Ward Hiram H. laborer, house 63 Chestnut
 Ward Jemima, dressmaker, bds. 73 William
 Ward John, laborer, h. r. 174 West avenue
 Ward Joseph B. (*Ward & Clark*), 31 Powers' buildings, boards 26 North avenue
 Ward Levi A. (*L. A. & L. F. Ward*), house Grove place c. Gibbs [3 Gibbs
 Ward Levi F. (*L. A. & L. F. Ward*), house
WARD L. A. & L. F. insurance agents, 2 and 4 Exchange place.—*See page 502*
 Ward Martha, widow, b. 136 Mt. Hope av.
 Ward Martin, laborer, boards 40 Saxton
 Ward Mary, widow, house 80 Smith
 Ward Michael, deceased, January 13, 1876
 Ward Michael W. cabinet moulder, 22 S. St. Paul, boards 11 Gorham
 Ward Mirunda, nurse, City Hospital, b. do.
 Ward Mortimer S. removed to Buffalo
 Ward Patrick, sawyer, house 40 Saxton

HENRY C. WISNER,

CRYSTAL BUD VASES, EPERGNES, ETC.,
 No. 33 STATE STREET.

Ward Patrick, switchman, N. Y. C. depot, house 92 Frank
 Ward Peter C. contractor, house 12 Mortimer
 Ward Susan, widow, house 173 N. Clinton
 Ward Thomas, removed to Morough, Ireland
 Ward Thomas, clerk, 230 State, h. 232 do.
 Ward Thomas, moulder, 150 North Water, house 104 Champlain
WARD WILLIAM H. secy. Citizens' Gas Co. 15 North St. Paul, b. 29 Allen.—*See page 493*
 Ward William H. carpenter, house 52 Hunter
 Ward Wm. J. tobacconist, 230 State, house 65 Jay
WARD & CLARK (*J. B. Ward & Curtis Clark*), insurance agents, 31 Powers' bldgs.—*See page 509*
 Wardell Jane, domestic, b. East avenue near Alexander [Norton]
 Wardell William, farmer, h. Goodman cor.
 Wardlaw Samuel D. photographer, 58 State, boards 146½ West Main
 Wardwell Edward J. & Co. fancy goods, 64 West Main, house 40½ Fitzhugh
 Ware Clinton H. clerk, 53 E. Main, bds. 13 Gregory
WARE JOB R. carpenter and builder, 40 Fulton av. house 1 Perkins.—*See page 635*
 Ware Wm. agent, 109 State, house 84 do.
 Ware Wm. M. painter, house 13 Gregory
 Warfield L. Belmont, boards 65 Meigs
 Warfield Richard H. Mrs. house 8 Tappan
 Warfield Richard N. & Co. (*Heman Churchill*), grocers, 195 Monroe avenue
 Waring Florence A. teacher, Concord School, No. 18, boards Joslyn park
 Waring Isabella E. widow, h. 90 Tappan
 Waring James, farmer, house Culver near Webster road [park]
 Waring John (*Waring & Scott*), h. 15 Joslyn
 Waring Mary E. Mrs. house 10 Joslyn park
 Waring Mary J. Miss, house 28 Meigs
WARING & SCOTT (*J. Waring and J. C. S. Scott*), coal, lumber and nursery, E. Main c. Goodman.—*See page 649*
 Wark David, physician, 26 Frank, house do.
 Wark Frederick, carpenter, house 33 Davis
 Wark John F. whip maker, Allen c. North Washington, h. 121 Frank [Tyler]
 Wark Thomas, W. machinist, 129 Mill, bds. 12
 Warncke Emily Mrs. tobacconist, 191 North Clinton, house do.
 Warncke Herman, mason, h. 96 St. Joseph
 Warncke Pedro, tobacconist, 128½ W. Main, house 191 North Clinton
 Warne Sarah, widow, house 199 Monroe av.
 Warner Andrew J. (*Warner & Cutler*), 64 Powers' bldgs. h. 17 N. Washington
 Warner Charles J. clerk, bds. 137 West av.
 Warner Charles S. dentist, 55 East Main, h. 110 University avenue
 Warner Clara D. Miss, b. Mt. Hope av. near Mt. Hope
 Warner Daniel, house 137 West avenue
 Warner Daniel J. jr. boards 137 West av.
 Warner David S. student, University of Rochester, boards 77 Atwater

Warner Franklin P. student, University of Rochester, bds. 39 Trevor Hall
 Warner Geo. E. student, 1 Baker's blk. b. W. Troup [house 121 Scio]
 Warner Geo. W. engineer, N. Y. C. R. R.
 Warner Geo. L. carpenter, h. 34 W. Troup
 Warner Horatio G. deceased, Feb. 11, 1876
 Warner Hulbert H. (*Warner, Stockbridge & Co.*), house 123 East av. c. Alexander
 Warner J. Foster, draughtsman, 64 Powers' bldgs. bds. 17 North Washington
 Warner Martin M. shoemaker, 75 N. Water, boards 4 York
 Warner Mary A. deceased, October, 1875
 Warner Matthew G. house 9 Union park
 Warner Matthew G. jr. lawyer, boards 9 Union park [Mt. Hope]
 Warner Sarah, widow, h. Mt. Hope av. near
WARNER, STOCKBRIDGE & CO. (*H. H. Warner, H. R. Stockbridge and J. L. Howard*), safes, 18 Arcade.—*See bottom end book* [139 Alexander]
 Warner Wm. insurance agent, 18 Arcade, h.
 Warner William A. draughtsman, 64 Powers' bldgs. boards 17 North Washington
 Warner Wm. C. carpenter, h. 75 Clifton
 Warner & Cutler (*A. J. Warner and J. G. Cutler*), architects, 64 Powers' bldgs.
 Warner, see Werner
 Warney John, cooper, house 5 Meigs
 Warnick John, laborer, boards 35 Hill
 Warnick Mary, widow, house 35 Hill
 Warnock Joseph R. harness maker, 128 East Main, house 46 South avenue
 Warrant Fred. W. salesman, 109 State, bds. Pleasant
 Warrant Frederick, salesman, b. 13 Pleasant
 Warrant John W. (*Warrant & Southworth*), 26 S. St. Paul, house 45 South avenue
WARRANT & SOUTHWORTH (*J. W. Warrant and J. B. Southworth*), copper-smiths, stoves and furnishing goods, 26 S. St. Paul.—*See inside back cover*
 Warren Edgar H. carrier, Post Office, b. 53 Hamilton place
 Warren Edward K. brewer, Atwater c. N. St. Paul, house 48 N. St. Paul
 Warren Eliza, saloon, 17 Market, house do.
 Warren Fred. M. clerk, 1 Hudson, boards do.
 Warren Gardner D. (*S. J. Arnold & Co.*), 103 State, house 31 Fitzhugh
 Warren Geo. carriage trimmer, h. 94 Front
 Warren Hiram N. grocer, 1 Hudson, h. do.
 Warren Leonard W. salesman, 134 Oak, h. 54 League
 Warren Lois M. widow, bds. 48 N. St. Paul
 Warren Loren O. foreman, house Monroe av. pear toll gate
 Warren Louis, teamster, h. 76 Broadway
 Warren Marion F. Miss, bds. 48 N. St. Paul
 Warren Silas K. agent, 55 S. St. Paul, house 5 Reynolds [Hunter]
 Warren Thomas, teamster, 33 West av. h. 37
 Warren Wm. H. waiter, National Hotel, h. 224 State
 Warren Wm. R. (*Henry Miles & Co.*), 83 S. St. Paul, house 76 Broadway [Sophia]
 Warriner Francis, supt. 187 W. Main, bds. 10

A. R. PRITCHARD & LIKLY,

TRUNKS AND BAGS, WHOLESALE AND RETAIL, No. 78 STATE STREET.

- Warth Frank F. teamster, house Hudson cor. Clifford [Alphonse n. Hudson]
 Warth Nicholas, laborer, 22 West avenue, h.
 Wartinger Caroline, widow, h. 29 Franklin
 Warwick Louis R. actor, Rochester Opera House, boards Chapman House
 Washburn Edward S. freight agent, 149 State
 Washburn Geo. H. salesman, 32 W. Main, boards 38 Atkinson
 Washburn Ruth A. widow, h. 38 Atkinson
 Washburne Fred. S. deceased, Dec. 1875
 Washington Louis, waiter, house 3 Plum al.
 Wasmer Mary A. widow, h. 43 Monroe av.
 Waterbury Norman M. student, University of Rochester, bds 110 University avenue
 Waterhouse Elbert, boards 33 Grape
 Waterman Alexander H. constable, boards 2 Frank
 Waterman Anson, teamster, b. 54 West av.
 Waterman Daniel M. removed from city
 Waterman David, engineer, N. Y. C. R. R. house 178 North
 Waterman Don C. printer, boards 27 Jones
 Waterman Eliza J. widow, house 33 Hudson
 Waterman Geo. W. engineer, b. 36 Caledonia avenue
 Waterman Thomas H. gilder, h. 131 West av.
 Waterous Abby Miss, boards 20 East avenue
 Waterous Charles L. real estate, boards 25 Hamilton place
 Waters A. F. widow, bds. University av. c. Goodman
 Waters Mary, domestic, house 44 Lorimer
 Waters Mary, house 56 Temperance bldgs.
 Waters Peter, laborer, bds. 56 Temperance bldgs.
 Waters W. A. cashier, Flour City National Bank, 1 Powers' bldgs. h. Grove c. Gibbs
 Waters Winslow W. carpenter, House of Refuge, house at Greece
 Waterston Alden D. saloon, 9 Monroe av. h. do.
 Waterston Alden D. jr. cigarmaker, 48 Exchange, bds. 9 Monroe avenue
 Waterstraat August, tailor, 6 Rauber, h. do.
 Waterstrat William, carpenter, h. 5 Philander
 Watervisser James, shoemaker, 2 Hudson, h. Wilson [Hudson, h. 76 do.
 Watervisser John D. V. boots and shoes, 2
 Watkins Richard, teamster, house Goodman near Park avenue [Plymouth av.
 Watley Simon, gardener, house rear 231
 Watson Albert M. house 16 North Clinton
 Watson Charles, liquors, 84 West Main, h. Saratoga av. opp. Ambrose
 Watson Charles H. student, b. 110 Genesee
 Watson Charles J. clerk, Flour City National Bank, 1 Powers' bldgs. bds. 3 W. Troup
 Watson C. V. physician, 180 Powers' bldgs. house 14 Clifton [Clinton
 Watson Don Alonzo, 22 Arcade, h. 28 North
 Watson Edward S. removed to Theresa
 Watson Eleanor W. Mrs. dry goods, 57 Lyell, house do.
 Watson Eliphalet, mason, house 37 Court
 Watson George T. clerk, 65 West Main, bds. Averell n. Broadway [13 Fitzhugh
 Watson George L. salesman, 73 E. Main, h.
 Watson Henry, watchmaker, b. 90 Hickory
 Watson Homer B. salesman, 73 East Main, boards 110 Monroe avenue
 Watson John, shoemaker, 91 North Water, house 200 N. St. Paul
 Watson John H. removed to Canada
 Watson Levitt F. house 5 Scrantom [Culver
 Watson Marshall, gardener, h. Sibley near
 Watson Mary, widow, house 3 West Troup
 Watson Richard, watchmaker, Court corner Stone, house 90 Hickory
 Watson William G. bookkeeper, Mt. Hope nurseries, and (McDowell & Co.), house 124 Mt. Hope avenue
 Watt Robert, maltster, house 3 Victoria
 Wattel Elizabeth, stitcher, bds. 49 Romeyn
 Wattel Mary A. widow, boards 49 Romeyn
 Wattel Rosa, stitcher, boards 49 Romeyn
 Wattel William J. cooper, house 289 Brown
 Watters Charles, teamster, house 7 Delevan
 Watters Daniel, tailor, 5 Front, h. 54 Tappan
 Watters Geo. D. boards 285 State [State
 Watters John E. (Watters & Doyle), house 285
 Watters Julia Miss, boards 308 State
 Watters & Doyle (J. E. Watters and H. F. Doyle), coal, 17 Warehouse
 Watts D. S. salesman, 73 East Main, boards 170½ West Main
 Watts Ebenezer Mrs. boards 24 Platt
 Watts Frederick B. clerk, 8 Hill, h. 24 Platt
 Watts Lewis D. carriage trimmer, boards 188 West Main [Exchange
 Waugh David, cutter, 24 State, house 222
 Waugh George E. cutter, 64 Mill, h. 12 Rome
 Waugh John T. sashmaker, h. 4 Briggs' blk.
 Waugh Samuel, shoemaker, b. 9 Briggs' blk.
 Waugh Thomas, mason, h. 9 Briggs' block
 Waurd Joseph, blacksmith, h. 17 Murray
 Waxelbaum Sarah, widow, h. 34 Clinton pl.
 Way Albert C. tailor, 9 Sophia, house do.
 Way Calvin R. tailor, 128 State, house do.
 Way Edwin S. telegrapher, 151 State, boards 4 N. Washington [128 State
 Way George M. carpenter, 18 Oak, boards
 Way Mark, tollgate keeper, Monroe av. h. do.
 Way Wm. H. shoemaker, h. 83 Broadway
 Wayland Francis, removed to Parma
 Wayland John H. removed to Parma
 Wayland Michael, removed to Parma
 Wayne Alonzo E. bartender, 23 Exchange place, boards 52 Troup
 Wayne Alfred E. clerk, boards 59 Lake av.
 Wayne Delia E. widow, house 59 Lake av.
WAYTE WM. EDWIN, market, 104 West Main, h. 127 Jones.—See page 554
 Weaver Chas. F. teamster, h. 16 Warehouse
 Weaver Charles F. (Pollock, Weaver & Co.), 17 West Main, house 165 Monroe av.
 Weaver Clara, boards 20 University avenue
 Weaver Delia W. widow, b. Marshall cor. Wadsworth square
 Weaver De Valson G. (Reed & Weaver), 111 State, house 16 North av. [house do.
 Weaver George, cigarmaker, 147 North av.
 Weaver Horace, boatman, h. Genesee near Strong [Andrews, b. 20 Scio
 Weaver John, can maker, North Water near
 Weaver John H. clerk, 8 East avenue, house 184 E. Main

Weaver Lucius E. salesman, 16 Exchange, b. 51 Park av.
 Weaver Mary Ann Miss, laundress, h. 7 Swan
 Weaver Robert M. (*Pollock, Weaver & Co.*), 17 West Main, boards 11 N. St. Paul
 Weaver Sally, widow, boards 165 Monroe av.
 Weaver Theodore, carver, boards 20 Scio
 Weaver Zacariah, gunsmith, 41 East Main, boards 41 Lancaster
 Webb Caroline Miss, boards 31 S. Union
 Webb Charles E. shoemaker, 87 N. Water, b. 76 Frank [bldgs, h. 31 S. Union
 Webb Charles H. insurance agent, 9 Powers'
 Webb Curtis, peddler, house 124 Broadway
 Webb Edward, toolmaker, house 46 Martin
 Webb Edward jr. toolmaker, bds. 46 Martin
 Webb Emma J. teacher, bds. 53 Reynolds
 Webb George, laborer, bds. 24 Champlain
 Webb George, toolmaker, bds. 342 Brown
 Webb Helen L. boards 24 Asylum
 Webb Henry, sawmaker, boards 46 Martin
 Webb Henry M. patternmaker, h. 3 Grace
 Webb Henry M. clerk, 12 Smith's block, b. 24 Rowley [24 Rowley
 Webb Hyatt E. clerk, 96 West Main, boards
 Webb Mary A. widow, house 58 Manhattan
 Webb Richard W. agent, boards 24 Rowley
 Webb Sarah, widow, boards Fourth av. near Central park
 Webb Sarah M. sewer, house 9 N. Ford
 Webb William, carpenter, 53 Reynolds, h. do.
 Webb William, laborer, house 24 Champlain
 Webb William H. physician, h. 24 Rowley
 Webb William W. lawyer, 9 Powers' bldgs. boards 31 South Union
 Webber Amory W. cabinetmaker, boards 64 North Clinton [n. Rowe
 Webber Charles, laborer, paper mill, h. Ninth
 Webber Frank, ice, boards 130 Frost av.
 Webber Frank M. turner, 3 Elizabeth, house Champlain near Genesee
 Webber George P. turner, 3 Aqueduct, house 53 Weld
 Webber James N. sawyer, foot Centre, h. 249 North [ton
 Webber Julia A. Miss, boards 64 North Clin-
 Webber Orrin B. machinist, 129 Mill, house 9 Warehouse [Scio
 Weber Adam, shoemaker, 87 E. Main, h. 89
 Weber Adelia, widow, house 34 Campbell
 Weber Albert, salesman, bds. 33 N. Frances
 Weber Andrew, hackman, b. 111 North av.
 Weber Anthony, mason, h. Channing n. North
 Weber Benedict, stone cutter, 22 West av. h. 33 North Frances
 Weber Catharine, widow, h. 109 Champlain
 Weber Catharine, widow, house 7 Otsego
 Weber Charles, laborer, boards 45 Kent
 Weber Chas. B. clerk, 38 St. S. Paul, b. 40 do.
 Weber Christian, tailor, 9½ Wilder, house do.
 Weber Conrad, laborer, paper mill, house 16½ Court
 Weber Emoron, shoemaker, h. 111 Orange
 Weber Frank, mason, house Straub alley n. McCracken
 Weber Fred, shoemaker, house 54 Herman
 Weber Frederick, carpenter, bds. r. 4 Delevan
 Weber George, teamster, boards 7 Otsego

Weber George, cutter, 44 Mill, h. 57 Chatham
 Weber George, clerk, 147 State, h. Saratoga avenue opposite Jones square
 Weber George, machinist, boards 149 Jones
 Weber George F. carver, 117 N. Water, bds. 21 Hope
 Weber George P. grocer, 61 Atwater, h. do.
 Weber George V. carpenter, h. 39 Sellinger
 Weber G. Adolph, machinist, Brown corner Jones, house 47 West Smith
 Weber Henry, tailor, house 5 Draper
 Weber Henry, baker, house 330 Brown
 Weber Henry G. harnessmaker, S. St. Paul corner Ely, boards 58 South St. Paul
 Weber Jacob, basketmaker, h. 48 Campbell
 Weber Jacob, switchman, house 40 Lyell
 Weber Jacob, tailor, house 180 N. Clinton
 Weber Jacob, shoemaker, h. Borchard near N. Clinton
 Weber Jacob, gate tender, N. Y. C. depot, house 149 Jones [149 Jones
 Weber James, machinist, Mill c. Factory, b.
 Weber John, blacksmith, 22 West av. house 9 Julia
 Weber John, laborer, house 113 Meigs
 Weber John, laborer, h. Bernard n. Hudson
 Weber John, fruit preserver, boards 20 Scio
 Weber John, deceased June 11, 1875
 Weber John A. shoemaker, 87 E. Main, house 89 Scio [89 Scio
 Weber John A. jr. shademaker, 15 Front, b.
 Weber John A. laborer, 22 West av. house 118 Whitney
 Weber Joseph, cutter, 72 Mill, h. 121 Orange
 Weber Joseph, cigar maker, 147 North av. boards 34 Campbell [bds. do.
 Weber Josie M. millinery, 40 South St. Paul
 Weber J. Martin, cabinetmaker, 123 Mill, b. 113 Meigs
 Weber Lawrence, laborer, 255 N. St. Paul, house St. Joseph near Norton
 Weber Libbie, stitcher, boards 20 Scio
 Weber Ludwig, mason, house 36 Weeger
 Weber Martin, carpenter, bds. 113 Meigs
 Weber Martin, gardener, house 122 Meigs
 Weber Martin J. cigarmaker, 106 Allen, b. do.
 Weber Mary, widow, house 20 Scio
 Weber Michael, carpenter, boards St. Joseph near Langham
 Weber Michael A. laborer, middle falls near North St. Paul, house 21 Hope
 Weber Olivia, widow, house 40 S. St. Paul
 Weber Sebastian, h. St. Joseph n. Langham
 Weber Sophia, widow, boards 45 Kent
 Weber Theodore, carver, boards 20 Scio
 Weber William H. blacksmith, 4 Ely, boards 9 Julia
 Webster Adarial E. paper hanger, house 10 Gregory
 Webster Charles, comedian, Rochester Opera House, b. Centre c. Mill
 Webster Charles H. delivery clerk, Erie R'y freight office, boards 130 Plymouth av.
 Webster Cornelia J. widow, house 51 Spring
WEBSTER EDWARD, lawyer, 82 Powers' bldgs. house 34 Jay.—*See page 512*
 Webster Edward A. discount clerk, 25 State, boards 34 Jay

- WEBSTER ELIJAH D.** boots and shoes, 117 East Main, house 106 Monroe av.—
See page 540
- Webster Elizabeth, widow, house 11 Park av.
- Webster Flavius J. engineer, h. 62 Chatham
- Webster Geo. W. machinist, boards 130 Plymouth avenue
- Webster Hartwell C. h. 130 Plymouth av.
- Webster Ludovico F. clerk, 40 Allen, boards 9 John
- Webster Mary E. Mrs. house 8 Gibbs
- Webster Noyes D. expressman, h. 11 Waverley place [ester, boards 34 Jay
- Webster Roy C. student, University of Rochester
- Webster R. N. Miss, teacher, h. 11 Park av.
- Webster Susan E. Miss, rem'd to Albion, N. Y.
- Webster S. Alice Miss, music teacher, 16 Matthews, boards do.
- Webster Theo. C. removed to Rocklin, Cal.
- Webster Wm. landscape gardener, h. 9 John
- Webster William, carpenter, h. 173 N. Clinton
- Webster William Mrs. music teacher, 9 John, house do. [bds. 7 Elm
- Webster W. Scott, student, 113 Powers' bldgs.
- Wechter Joseph, farmer, House of Refuge, house Costar n. Saratoga avenue
- Weckesser Joseph, cabinet maker, 2 Hill, h. 90 St. Joseph
- Wedd Emma Mrs. house 7 Monroe avenue
- Wedd Helen A. teacher, Oakman School No. 20, boards 87 Manhattan
- Wedd Matthew C. patternmaker, house 87 Manhattan
- Wedge Alfred H. plumber, 25 Exchange, b. 34 Gibbs
- Wedow William, cabinetmaker, 2 Hill, h. 199 Scio
- WEED SEWING MACHINE CO.** (T. S. Maxwell, manager), 18 E. Main.—See p. 546
- Weed Eli (Pratt & Weed), 92 Mill, house 21 Jones avenue
- Weed Fellows, expressman, b. 21 Jones av.
- Weed John W. laborer, 10 Spring, h. 19 do.
- Weed Louis E. bookkeeper, bds. Protective hose house [199 North
- Weed William A. fireman, N. Y. C. R. R. h.
- Weeks Amanda D. widow, h. 196 Monroe av.
- Weeks Loren R. salesman, 36 Exchange, h. 194 Monroe avenue
- Weeks Luman C. salesman, 18 E. Main
- Weeks Willard A. clerk, Erie railway freight house, house 6 James [fort
- Weeks William A. cigar dealer, h. 10 1/2 Com-
- Wegellie Cornelius, basket maker, house 60 St. Joseph [36 Sanford
- Wegman Alphonzo H. clerk, 58 State, bds.
- Wegman Andrew, carpenter, 7 N. Water, boards 39 North avenue
- Wegman Andrew, agent, house 36 Sanford
- Wegman Andrew J. (Allen & Wegman), 62 East Main, boards 36 Sanford
- Wegman Ann, grocer, 182 N. St. Paul, h. do.
- Wegman Balthasar, flour, 39 North av. h. do.
- Wegman Frances Miss, clerk, 3 Lowell, bds. 6 Gorham [Hudson
- Wegman Frederick, cooper, h. Channing n.
- Wegman Frederick, tailor, house 82 Lincoln
- Wegman George, laborer, house 26 Grand
- Wegman George, house 8 Elizabeth place
- Wegman Geo. J. blacksmith, h. 408 Brown
- Wegman Henry, cabinetmaker, 69 North St. Paul, boards 8 Elizabeth place
- Wegman Jacob, laborer, bds. N. Clinton n. city line [49 Spring
- Wegman John (J. B. Wegman & Co.), house
- Wegman John, cartman, house 5 Cole
- Wegman John jr. miller, Flour City Mills, house 42 Lake avenue
- WEGMAN JOHN B. & CO.** (J. Wegman), furniture, 44 East Main, bds. 49 Spring.—See page 629
- Wegman Lena, widow, boards 6 Gorham
- Wegman Louis A. clerk, 44 East Main, bds. 49 Spring [versity av.
- Wegman Mary A. dressmaker, h. 102 Uni-
- Wegman William, clerk, 8 White, boards 42 Lake avenue
- WEHLE CASPAR**, sausagemaker, Front cor. Mumford, h. do.—See page 553
- Wehle Jacob, cabinet maker, 22 South St. Paul, house 10 Henry
- Wehle William, cigarmaker, bds 10 Henry
- Wehn George, bookkeeper, bds. 359 Brown
- Wehn George E. bookkeeper, 111 North St. Paul, boards do.
- Wehn Louis, insurance agent, Roch. Savings Bank bldg. house 359 Brown [Brown
- Wehn Louis W. clerk, 63 Front, boards 359
- Wehner Ignatz, laborer, Rochester Cotton Mill, house 12 Whitney
- Wehner Polikarb, laborer, Rochester Cotton Mill, house Hague near railroad
- Wehnert Lawrence, tailor, 23 Pryor, h. do.
- Wehrle Frank J. cabinetmaker, h 66 Kelly
- Wehrle Frederick, carpenter, r. 59 Asylum, house 36 Kirk [Kirk
- Wehrle Frederick W. machinist, boards 36
- Weibans August, painter, 14 Stone, house 41 Atwater
- Weibel Charles, moulder, bds. 29 Holland
- Weibel Jacob, tailor, house 21 Oregon
- Weible Frederica, widow, house 10 Hope
- Weible Jacob, deceased August, 1875
- Weible John, optician, boards 10 Hope
- Weichbrodt August, laborer, house 24 McDonald avenue
- Weichbrodt William, laborer, h. 48 Kelly
- Weicher Frank B. clerk, 87 North Water, boards 31 Martin [31 Martin
- Weicher Henry, tanner, 87 North Water, h.
- Weicher Jacob J. (Caring, Weicher & Co.), 87 North Water, boards 11 St. Joseph
- Weicher Nicholas G. shoecutter, b. 31 Martin [31 Martin
- Weicher Peter-J. shoecutter, 81 N. Water, b.
- Weick Fred, tinsmith, boards 30 Foehner
- Weidemueller Conrad, engineer, house 114 Chatham
- Weidemueller Henry, removed to Henrietta
- Weidemueller John, machinist, h. 51 Lowell
- Weidemueller Rudolph, boiler maker, Platt near Jones, boards 114 Chatham
- Weidenboerner John, cabinet maker, 2 Hill, house 77 South Union
- Weidenboerner Leonard, grocer, 64 Monroe avenue, house do.

- Weider John, tailor, house 46 Nassau
 Weider Phillip, grocer, 34 Grand, house do.
 Weider William J. pressman, 82 W. Main, boards 34 Grand
 Weidner C. Gustavus, foreman, Platt near Jones, h. 39 St. Joseph [Front, h. do.
 Weidner George, Commercial Hotel, 102
 Weidner John, laborer, house 9 Bay [Front
 Weidner John, upholsterer, 50 E. Main, b. 102
 Weier Frederick jr. shoemaker, 91 N. Water, house 43 Hand [bds. 43 Hand
 Weier Herman F. shoemaker, 91 N. Water,
 Weier Rudolph W. shoefinisher, 91 North Water, house 43 Hand
 Weigand George, moulder, boards 99 Meigs
 Weigand Helen, widow, house 99 Meigs
 Weigand Joseph, boots and shoes, 5 Magne, house do. [1 McDonald av.
 Weigand Joseph A. marble polisher, house
 Weigand Matthew, wagon maker, Goodman cor. East Main, house 87 Weld
 Weigand Matthew A. marble polisher, bds. 87 Weld
 Weigand Nelson R. finisher, River near N. Water, house 51 Rauber [ford, h. do.
 Weigel Anna M. saloon, Hudson cor. Cliff-
 Weigel August, nurseryman, house Hunter near Reynolds
 Weigel Caroline E. widow, h. 59 N. Clinton
 Weigel Charles E. clerk, bds. 59 N. Clinton
WEIGEL FRANCIS X. druggist, 57 N. Clinton, house 59 do.—*See page 569*
 Weigel George, shoemaker, 73 North Water, boards 97 Cady
 Weigel Joseph, shoemaker, house 97 Cady
 Weigel Joseph jr. packer, 16 Exchange, bds. 97 Cady
 Weigel Libbie, tailoress, 65 Bartlett, b. Cady
 Weigel Louis A. physician, 57 North Clinton, boards 59 do.
 Weigel Lucy, widow, house 61 Prospect
 Weighell Isaac, boots and shoes, 73 Exchange, boards 111 Fitzhugh
 Weil Samuel (*H. Exstein & Co.*), 54 Mill, b. 71 North Clinton [Gregory
 Weiland Frederick F. carpenter, boards 57
 Weiland Godfrey, carpenter, 10 South Water, house 57 Gregory
 Weiland Joseph, shoemaker, 20 Catharine, house 10 McDonald av. [ald av.
 Weiland Margaret, widow, bds. 10 McDon-
 Weiland Otto A. driver, 40 Front, boards 11 Hand
 Weiland Teresa, widow, house 5 Nassau
 Weilert Edward, blacksmith, h. 74 Whitney
 Weilert Edward 2d, hairdresser, house 107 Chatham
 Weilhamer Charles T. soap manufacturer, 90 North avenue, house do.
 Weimar Louis, tailor, house 64 St. Joseph
 Weinberg Abraham, house 8 Ely
 Weinberg Michael, 76 State, boards 8 Ely
 Weingartner Catharine, widow, h. 40 Nassau
 Weingartner Catharine, tailoress, b. 61 Kelly
 Weingartner Charles, laborer, h. 259 North
 Weingartner Geo. F. butcher, h. 87 Chatham
 Weingartner Geo. F. cigar manuf. 59 1/2 Chatham, boards 61 Kelly
 Weingartner Jacob, tailor, 64 Kelly, boards 61 do
 Weingartner J. Joseph, boots and shoes, 85 Chatham, house 61 Kelly
 Weingartner Leonardt, bootmaker, 92 State, house 6 Holland [Vienna
 Weingartner Louis, shoemaker, house 22
 Weingartner Marburger, widow, b. 22 Nassau
 Weining Anthony J. clerk, bds. 34 Lowell
 Weining Frank, deceased March, 1876
 Weining John, grocer, 60 Lowell, h. 30 do.
 Weining John, cigar maker, 92 N. Clinton, boards 34 Lowell [Lowell
 Weining Mary F. tailoress, 48 Martin, b. 34
 Weinmann Charles G. brewer, 165 Jay, b. do.
 Weinmann Frank, deceased March 14, 1876
 Weinmann John B. laborer, Exchange opp. Glasgow, house 7 Hunter
 Weinmann Margaret, brewer, 165 Jay, h. do.
 Weinstein Henrietta, house 74 N. St. Paul
 Weinstein Rosa, removed to Cawley, Pa.
 Weinstein Victor, bookkeeper, 52 State, bds. 74 N. St. Paul
 Weir George, clergyman, house 24 Gregory
 Weir Maria, nurse, house 24 Gregory
 Weir Michael, carpenter, house 26 Atkinson
 Weir William B. student, Roch. University, b. University av. opp. Upton park
 Weir, see Weier
 Weirauch Daniel, grinder, 120 Mill
 Weirich Henry, sawyer, 133 North Water, boards 32 Franklin [n. city line
 Weirich Nicholas, laborer, h. r. N. Clinton,
 Weirich Peter, carpenter, house 21 German
 Weis Albert, laborer, house 95 Scio
 Weis Barbara, widow, house 50 North av.
 Weis Caroline, widow, house 36 Grand [av.
 Weis Catharine, widow, h. Field n. Monroe
 Weis Chas. clerk, 21 W. Main, b. 7 Hickory
 Weis Elizabeth, widow, h. 321 N. St. Paul
 Weis Francis, flagman, house 57 W. Maple
 Weis George W. butcher, boards 150 Jay
 Weis Jacob, cabinetmaker, bds. 4 W. Maple
 Weis John, woodsawyer, at N. Y. C. R. R. and (*Hahn, Weis & Co.*), h. 7 Hickory
 Weis John, cooper, 25 Moore, house do.
 Weis John B. cooper, 150 Jay, house do.
 Weis John Peter, laborer, 54 Fitzhugh, house 13 Nassau
 Weis Joseph, laborer, bds. 321 N. St. Paul
 Weis Lawrence, foreman, house Field near Monroe avenue
 Weis Nicholas, shoemaker, house 5 German
 Weis Rudolph, proprietor, Mt. Hope avenue House, 120 Mt. Hope avenue, and (*Hahn, Weis & Co.*), house do. [7 Hickory
 Weis Rudolph R. salesman, 53 E. Main, bds.
 Weis William H. marble cutter, 166 State, boards 13 Nassau
 Weisenburger Anthony, shoemaker, h. 125 South avenue
 Weisenburger Joseph A. laborer, Exchange opp. Glasgow, house 102 Chatham
 Weisenburger Louisa Miss, b. 125 South av.
 Weisenfeldt Geo. blacksmith, h. 56 Orange
 Weisenmiller John J. laborer, house 269 St. Joseph
 Weiser John, blacksmith, house 112 Hunter

Weiser John jr. stonecutter, bds. 112 Hunter
 Weiser Lewis, carpenter, house r. N. Clinton
 near Norton [Cady
 Weiser Wm. B. blacksmith, 3 Canal, h. 134
 Weissgerber George, gilder, house 32 German
 Weishaar Max, druggist, 84½ North avenue,
 house 98 do.
 Weismon Isaac, peddler, house 4 Gregory
 Weiss Erhardt, blacksmith, Brown's race n.
 Furnace, house 36 Front
 Weiss Ernst, tailor, boards 65 Herman
 Weiss George, laborer, h. Seventh n. Emerson
 Weiss George C. clerk, 40 State, b. 18 Weld
 Weiss John F. brakeman, N. Y. C. R. R. h.
 32 McDonald avenue
 Weiss Jules C. cutter, 10 W. Main, boards
 Osburn House
 Weiss Julia, widow, h. West Maple n. Hague
 Weissinger Charles F. clerk, Post Office,
 house 52 Hanover
 Weissteiner Aloys, ass't pastor St. Peter and
 Paul's church, East Maple, bds. do.
 Weiszer Julius, grinder, h. Alphonse near
 Henry
 Weitemiller John, machinist, Brown corner
 Jones, house 51 Lowell
 Weith Ella, widow, boards 29 Vienna
 Weitz Anthony, soap peddler, h. 3 Finney
 Weitzel Adam, engineer, N. Y. C. R. R. h.
 11 Woodbury [b. 10 Pitt
 Weitzel Frederick W. clerk, 127 East Main,
 Weitzel Henry H. baker, 46 S. St. Paul, h. do.
 Weitzel Henry H. jr. peddler, 46 S. St. Paul,
 boards do. [Main, h. 10 Pitt
 Weitzel John N. (*Leat & Weitzel*), 127 East
 Welch Edward, removed from city
 Welch Edward B. tinsmith, 144 E. Main, b.
 rear 36 Griffith
 Welch Frances A. stitcher, boards 7 Lyell
 Welch Frank E. clerk, 37 Scio, boards do.
 Welch George R. (*Welch & Firman*), house
 51 Charlotte
 Welch Hattie Miss, boards 15 Charlotte
 Welch James, switchman, boards Leighton
 avenue n. Culver [3 Vought
 Welch James, tobacco cutter, 23 W. Main, b.
 Welch James, laborer, house 7 Litchfield
 Welch James G. grocer, 115 University av.
 house do.
 Welch Johanna Mrs. house 150 Cady
 Welch John, waiter, Osburn House
 Welch John, mason, house 4 Smith [rapids
 Welch John, farmer, house Wolcott road n.
 Welch John L. hostler, h. 3 Plymouth av.
 Welch Joseph A. carriage trimmer, 3 Canal,
 boards 102 Jay
 Welch Katie, domestic, 46 Jones avenue
 Welch Margaret, house 16 Howell
 Welch Martin, painter, 14 Stone, b. 23 Joiner
 Welch Mary, widow, house 23 Joiner
 Welch Mary, removed from city
 Welch Michael, laborer, boards 150 Cady
 Welch Patrick, carpenter, house 148 Cady
 Welch Patrick, laborer, house 140 Jones
 Welch Thos. coachman, 91 Fitzhugh, b. do.
 Welch Timothy, laborer, h. Munger n. South
 avenue
 Welch Wm. switchman, boards 21 Jones

WELCH & FIRMAN (*G. R. Welch and
 W. S. Firman*), insurance agents, 12
 Smith's block.—See page 506
 Welch, see Walsh and Welsh
 Weld Roswell R. (*Weld & Jackson*), boards
 27 N. St. Paul [booksellers, 4 Arcade
 Weld & Jackson (*R. W. Weld and A. Jackson*),
 Weldele Andrew, brushmaker, bds. 149 Jay
 Weldele Rosalie, widow, house 149 Jay
 Weldon George, removed to Greece
 Weldon George & W. paper hangings, 52 E.
 Main, boards 77 North Union
 Weldon Henry G. house 77 North Union
 Weldon James, removed to Greece
 Weldon James Z. clerk, 52 E. Main, bds. 77
 North Union [North Union
 Weldon Walter (*G. & W. Weldon*), boards 77
 Welker Adam, cooper, 5 Charles, house 147
 West Maple
 Welker Andrew, shoemaker, h. 182 N. Clinton
 Welker August, deceased, February, 1876
 Welker Charles J. tailor, b. 74 St. Joseph
 Welker Conrad, laborer, house 279 Jay
 Welker Eugene, carpenter, house 63 Herman
 Welker Mary, widow, house 124 Orange
 Welker Mary A. widow, h. 74 St. Joseph
 Welker Valentine, engineer, Brown c. Erie
 canal, house 231 Jay [Maple
 Welker Waltberger, widow, boards 145 W.
 Weller Alphonse, shoemaker, h. 51 Temper-
 ance buildings
 Weller Jacob, tailor, house 7 Baden
 Weller John, house 1 Olean [Hanover
 Weller J. Leonard, laborer, h. Herman cor.
 Weller Nellie Miss, dressmaker, b. 114 State
 Wellington John R. clerk, 1 East park, h. 62
 Asylum
 Wellman Emily Mrs. nurse, h. 136 Adams
 Wells Alice S. Miss, boards 28 Spring
 Wells Charles, foreman, house rear 335 State
 Wells Charles jr. machinist, b. r. 335 State
 Wells Edward, superintendent, 3 Canal, h.
 82 West avenue
 Wells Frankie L. boards 64 East avenue
 Wells George W. teamster, 65 N. Water, h.
 180 East Main [Waverley House
 Wells Henry, bookkeeper, 120 Mill, boards
 Wells James M. teacher, Free Academy, b.
 31 Andrews [house 20 Edmonds
 Wells Jerome B. flour, &c., 220 East Main,
 Wells Mark, conductor, N. Y. C. R. R. bds.
 Congress Hall
 Wells Samuel, laborer, boards 20 Market
 Wells Samuel, toolmaker, 120 Mill, boards
 335 State [82 West avenue
 Wells Wilbur E. carriage trimmer, 3 Canal, b.
 Wells Wm. C. agent, 45 E. Main, boards 36½
 South St. Paul [121½ Tremont
 Wells William H. (*Wells & Parker*), house
 Wells & Parker (*William H. Wells and F. A.
 Parker*), grocers, 68 West avenue
 Welner John, blacksmith, house 46 Sellinger
 Welpe Charles, printer, 149 N. Water, house
 2 Emmett
 Welp John, compositor, house 2 Emmett
 Welsh Bridget, widow, house 3 Vought
 Welsh James, ship carpenter, b. 3 Vought
 Welsh John, laborer, h. 7 Kent alley n. Jay

HENRY C. WISNER,

MAJOLICA, KIWOTA AND JAPANESE CHINA,
 No. 33 STATE STREET.

- Welsh Mary L. dressmaker, b. 7 Kent alley
 Welsh Michael, laborer, house 48 Frank
 Welter Nicholas, tailor, 4 Mill, house 6 Oak-
 land park [13 Whitney
 Weltz George, laborer, Brown cor Jones, h.
 Welz Charles, turner, River n. N. St. Paul,
 house 7 Hoeltzer
 Wemple Mary, dressmaker, house 23 Lyell
 Wendelgass Benedicta, widow, b. r. 183 Al-
 exander [Water, h. Hudson n. Berlin
 Wendelgass Constantine, finisher, 15 North
 Wendell George, glass blower, 178 Plymouth
 avenue, boards 146 do.
 Wendell Matthew T. carpenter, h. 19 William
 Wendorfer Henry, grocer, 18 South av. h. do.
 Wendt Frederick, laborer, house Thomas
 Wenghart Joseph, laborer, house 81 Hickory
 Wenglein George, boiler maker, Platt near
 Jones, house 21 Wilder
 Weniger Albert H. harness maker, 79 Ex-
 change, house 24 St. Joseph
 Weniger Clara, deceased, August 10, 1875
 Weniger Helen, dressmaker, boards Hollister
 n. city line [h. Hollister n. Clifford
 Weniger Henry, harness maker, 128 E. Main,
 Wenner Daniel, gardener, house Falls
 Wenner George W. laborer, h. r. 26 German
 Wenner Henry J. cabinet maker, 184 State,
 boards Falls
 Wenner Michael, laborer, house 126 Wilder
 Wenner William H. cabinet maker, 184 State,
 boards Falls [Alexander
 Wensel Mary G. domestic, b. East av. corner
 Wenterkorn Andrew, laborer, b. 85 S. Union
 Wenterkorn Louis, laborer, h. 85 S. Union
 Wentworth Delos, lawyer, 67 Powers' bldgs.
 house 12 William
 Wentworth Frederick S. clerk, b. 12 William
 Wentworth Leigh R. printer, 82 West Main,
 house 22 Warner [h. 76 Court
 Wentworth Reginald H. printer, 82 W. Main,
 Wentz Jacob & Co. nurserymen, house East
 Main c. Prince [grocers, 234 E. Main
 Werden Brothers (S. W. and W. S. Werden),
 Werden John, tailor, 28½ East Main
 Werden S. W. (Werden Bros.), h. 234 East
 Main
 Werden Walter S. (Werden Bros.), boards 13
 Chestnut
 Werder John, tailor, 28½ East Main, h. 39
 Hollister [Lowell
 Werkmeister Frank, boiler maker, house 61
 Werndle Emil, watchman, Arcade, house 17
 Ontario
 Werndle Frederick, tailor, b. 58 N. Clinton
 Werndle Valentine, saloon, 58 N. Clinton,
 house do.
 Werner Amelia, widow, house 33 Baden
 Werner August F. machinist, h. 110 Orange
 Werner Charles, laborer, house 18 Vienna
 Werner Charles, gunsmith, 3 W. Main, b. 14
 Hawkins [b. do.
 Werner Edward, hairdresser, 196 N. Clinton
 Werner Edward, boards 195 North Clinton
 Werner Frank, laborer, h. Finney n. Tyler
 Werner Frank O. varnisher, 184 State, bds.
 110 Orange [house do.
 Werner George, saloon, 261 North Clinton,
 Werner George, saloon, 40 E. Main, house 53
 North Clinton
 Werner Ignatz, laborer, house 12 Whitney
 Werner Jacob, bootmaker, 92 State, house 55
 Rauber [47 Charlotte
 Werner John C. salesman, 73 E. Main, bds.
 Werner Julius, stonecutter, 22 West avenue,
 house 23 Wilder
 Werner Leopold, laborer, h. 190 St. Joseph
 Werner Lewis, laborer, house Wilcox
 Werner Louis, stonecutter, 22 West av. bds.
 23 Wilder [Clinton, house do.
 Werner Matilda Mrs. dressmaker, 196 North
 Werner Otto F. gunsmith, 40 E. Main, house
 128 North Union [h. 27 Wilder
 Werner Philip, stonecutter, 22 West avenue,
 Werner William, laborer, house Allmeroth
 near Henrietta avenue
 Werth Adam, carpenter, house 33 Oakman
 Werth Frank J. shoecutter, 55 Mill, boards
 55 Cady
 Werth Henry, shoecutter, 55 Mill, h. 55 Cady
 Werth John A. solecutter, 55 Mill, b. 55 Cady
 Werth Louis, solecutter, 55 Mill, b. 55 Cady
 Werth Peter 2d, bootmaker, 92 State, house
 125 Lyell
 Werth Peter, grocer, 69 Reynolds, house do.
 Wertheimer John, laborer, house Clifford n.
 Thomas [Atwater cor. Joiner
 Werth Jacob, machinist, 179 N. St. Paul, h.
 Wescott Benjamin R. butcher, 78 Bartlett
 Wescott Daniel P. horticulturist, h. 39 Stone
 Wescott George E. filecutter, bds. 68 Strong
 Wescott Helen T. dressmaker, h. 4 Evergreen
 Wescott, see Westcott
 Wesley Elizabeth, employment agency, 7
 Fitzhugh, house do. [13 Jones
 Wesley Geo. B. clerk, Platt c. Kent, boards
 Wesley James S. switchman, Platt st. cross-
 ing, house 13 Jones near Centre
 Wesley Wm. H. student, 84 Powers' bldgs.
 boards 9 North Washington
 Wesp Christopher, cigarmaker, Mill corner
 Factory, boards 4 Saxton
 Wesp Elizabeth, widow, house 4 Saxton
 Wesp Emil, shoecutter, boards 4 Saxton
 Wesp Emil, shoemaker, 73 N. Water, boards
 4 Saxton
 Wessels Jane G. widow, house 28 Goodman
 Wessels Matthias, clerk, 89 Monroe avenue,
 boards 28 Goodman
 Wessensel Geo. repairer, Erie railway shop
 West Annie Miss, 205 Plymouth av. boards
 73 Bartlett
 West Caroline E. widow, b. 17 Clinton place
 West Charles, market, 61 Lyell, house do.
 West Elinor, widow, house 40 Strong
 West Fred. J. salesman, 64 State, boards 66
 South St. Paul
 West George, engineer, N. Y. C. R. R. house
 41 Tyler
 West Julia Miss, stitcher, boards 13 Stillson
 West Leonard, clerk, bds. Cliff near Lake av.
 West O. Edward, steward, house 73 Bartlett
 West Robert W. bookkeeper, 172 W. Main,
 boards 9 Elm
 West William, house 5 Hope
 West Wm. H. axemaker, house 213 State

- Westbury Alex. actor, boards Violetta near Plymouth avenue
- WESTBURY DAVID H.** boot and shoe manuf. 79 N. Water, h. 133 Caledonia avenue.—*See page 542*
- Westbury David H. jr. bookbinder, 29 West Main, boards 133 Caledonia avenue
- Westbury Edward, gasfitter, bds. Violetta n. Plymouth avenue [Plymouth av.]
- Westbury James, laborer, house Violetta n.
- Westbury Mary, widow, b. 133 Caledonia av.
- Westbury Susan M. widow, h. 140 Plymouth avenue
- Westbury Wm. teamster, 74 State, b. Mansion
- Westbury William M. clerk, 79 N. Water, boards 133 Caledonia avenue
- Westcott James, machinist, house 1 Augusta
- Westcott James, clerk, 8 Railroad av. boards 228 North Clinton [Brighton av.]
- Westcott Phebe B. dressmaker, h. Rowley c.
- Westcott Warner (*Westcott & Houston*), 196 State, house 68 Lyell
- Westcott William W. carpenter, boards Rowley corner Brighton avenue
- WESTCOTT & HOUSTON** (*W. Westcott and C. G. Houston*), stoves and tinware, 196 State.—*See page 626*
- Westcott, see Westcott [13 Asylum]
- Westerhold Frederick, watchmaker, boards
- Westerman Bertha, widow, house 51 Gibbs
- Westerman Joseph, blacksmith, Oak corner Smith, house at Gates
- Westerman Julia A. dressmaker, b. 82 Court
- Westerman Louis, cutter, 74 Mill, boards 95 Atwater
- Western House of Refuge, Backus avenue
- Western New York Agricultural Society, 3 Smith's block
- Western Union Telegraph, 11 Arcade
- WESTERVELT HENRY R.** gen'l agent Buckeye mower and reaper, Ford cor. Erie canal, h. at Ovid.—*See page 677*
- Westervelt Ralph H. clerk, Ford cor. Erie canal, boards 12 East Main
- Westfall Charles L. teamster, house Bismarc near Genesee
- Westfall John N. safe agent, bds. 18 Favor
- Westfall Mary E. principal, Seward School, No. 19, boards Magnolia cor. Seward
- Westfall Taylor H. (*Westfall & Co.*), 28 East Main, h. 21 S. St. Paul [German]
- Westfall William, mason, h. N. Union near
- Westfall William, well borer, b. 17 St. Joseph
- Westfall & Co. (*T. H. Westfall and J. J. Bancker*), billiards, 28 East Main
- Westholmes Laurence, stonecutter, 22 West avenue, boards 12 Favor
- Weston Alonzo S. assistant R. R. master, Centre cor. Mill, house 28 Walnut
- Weston Dianthe M. widow, b. 103 Hudson
- Weston John, hackman, bds. 88 Exchange
- Weston William G. (*Whittlesey & Weston*), 34 Plymouth avenue, house 118 Bartlett
- Westphal John, boards Thomas n. Alphonse
- Westveer Elizabeth, widow, bds. 105 Hudson
- Westveer Leonard, painter, 5 S. St. Paul, h. 8 Huntington
- Wetmore Curtis G. agent, bds. 89 Fitzhugh
- Wetmore Elizabeth P. Mrs. teacher, Central School, No. 5, bds. 26 Greig
- Wetmore Ette J. hostler, house 153 E. Main
- Wetmore Lansing G. (*Scrantom & Wetmore*), 12 State, house 31 Tremont
- Wetzel George, tanner, 37 N. Water, house 16 Mt. Vernon avenue [173 Jay]
- Wetzel Nicholas, cooper, West near Lyell, h.
- Wevill George S. engraver, 59 Arcade, bds. Reed House [h. 26 Caledonia av.]
- Weyant Benjamin, engineer, Erie Railway,
- Weyburn Lorenzo D. physician, 14 First, house do.
- Weydeemiller Henry, removed from city
- Weyranch Daniel, grinder, b. 126 St. Joseph
- Weyranch George J. temperer, bds. 3 Pryor
- Weyranch Jacob, house 126 St. Joseph
- Whalen Bridget, house 28 Stone
- Whalen Daniel, carpenter, house 8 Magne
- WHALEN DENNIS**, ornamental plasterer, 16 Stone, h. 28 Marshall.—*See page 654*
- Whalen Eugene, plane maker, b. 29 Marietta
- Whalen James, clerk, 19 E. Main, b. 59 Frank
- Whalen John, removed from city
- Whalen John, laborer, boards 238 State
- Whalen John H. boilermaker, Brown cor. Jones, h. 11 Railroad alley [10 Jay]
- Whalen Lewis, tobacco worker, 182 State, h.
- Whalen Lewis A. fireman, boards 10 Jay
- Whalen Martin, laborer, house 238 State
- Whalen Mary, widow, house 58 Adams
- Whalen Mary, widow, house 29 Marietta
- Whalen Patrick, laborer, b. Saxton n. Lyell
- Whalen Patrick W. tailor, 68 Smith's block, boards 238 State
- Whalen Richard F. packer, bds. 59 Frank
- WHALEN RICHARD & T.** tobacco manufacturers, 182 State, house 59 Frank.—*See page 566*
- Whalen Sarah J. teacher, Andrews School, No. 9, bds. 28 Marshall
- Whalen Thomas, laborer, house 28 Frost av.
- Whalen Timothy (*R. & T. Whalen*), 182 State, house 73 Allen
- Whaples Calvin, tinner, house 20 Cottage
- Wheat Orin I. sawyer, bds. 13 Newton blk.
- Wheat Solomon L. removed from city
- Wheater Robert, house 26 Stillson
- Wheaton John, coal, 145 Pinnacle av. house 64 South avenue [South avenue]
- Wheaton Joseph, boat builder, house 60
- Wheaton Wilbur J. printer, 25 W. Main, b. 64 South avenue
- Whedon Jane, widow, house 64 Pearl
- Wheeler Albert G. police justice, City Hall, h. Exchange c. Greig
- Wheeler Amos, cutter, house 68 Asylum
- Wheeler Artemas H. (*Cowles, Curtis & Co.*), 15 Mill, boards Brackett House
- Wheeler Charles H. agent, b. 132 Frank
- Wheeler Charles H. bootmaker, 87 N. Water, house 139 Jones
- Wheeler Charles W. laborer, h. 27 Monroe av.
- Wheeler Cornelia M. widow, b. 36½ Marshall
- Wheeler David, constable, boards 274 State
- Wheeler David L. saloon, 18 Spring, h. do.
- Wheeler Edward, bookkeeper, 66 Mill, house 36½ Marshall

HENRY C. WISNER,

COCKSON & CHETWYND'S WHITE GRANITE WARE, No. 33 STATE STREET.

- Wheeler Frederick, lock finisher, Court cor. Stone, house 13 Whitmore park
 Wheeler George N. watchmaker, 6 Masonic block, bds. 114 W. Main
 Wheeler Harlan P. coal, Allen cor. Litchfield, house 8 New York
 Wheeler Helena M. removed to Rockford, Ill.
 Wheeler John J. janitor, Powers bldgs. h. 80 Adams
 Wheeler John W. grocer, 24 Hunter, h. do.
 Wheeler Josiah, coal dealer, Litchfield cor. Allen, house 65 Allen
 Wheeler J. Morrison, clerk, Litchfield cor. Allen, house 322 Brown
 Wheeler Louis, market, 106 North av. b. do.
 Wheeler M. Parsons, clerk, 123 State, house 12 Frank
 Wheeler Nellie, waiter, Ayer's Hotel, b. do.
 Wheeler Sarah Miss, matron of Industrial School, 76 Exchange, boards do.
 Wheeler Stephen, lawyer, h. 158 West av.
WHEELER WESLEY, pawnbroker, 6 Masonic block, h. 114 W. Main.—See page 508
 Wheelock Russell A. watchmaker, Court c. Stone, boards 29 South
 Whelan James, salesman, 93 State, house 51 Caledonia avenue [h. 60 Herman
 Wheler John C. hairdresser, 261½ N. Clinton
 Whipple Barney, laborer, h. Ninth n. Rowe
 Whipple Eleanor Miss, artist, 89 S. Union, boards do.
 Whipple Frank, shoemaker, h. 249 State
 Whipple Henry D. machinist, Court corner Stone, house 37 Hickory
 Whipple J. D. produce dealer, 197 E. Main, house at Irondequoit [California
 Whipple Marsh, removed to San Francisco
 Whipple Phebe C. widow, h. 89 S. Union
 Whipple Sarah, b. East avenue c. Alexander
 Whitaker William F. shoemaker, 83 North Water, house 4 Allen's alley
 Whitbeck Charles, driver, Hose No. 1. 36 Stone, bds. do.
 Whitbeck Charles L. driver, b. 34 Delevan
 Whitbeck Clark N. removed to Albany
 Whitbeck Dewitt C. superintendent, house 37 North avenue
 Whitbeck Frank C. (*Whitbeck & Dobbs*), 205 East Main, boards 34 Delevan
 Whitbeck George H. teamster, h. 74 Asylum
 Whitbeck George V. driver, fire engine No. 2, boards 34 Delevan
 Whitbeck George W. teamster, Central Mill, house Asylum
 Whitbeck Jas. H. meter inspector, Citizen's Gas Co. 15 N. St. Paul, h. Vick park
 Whitbeck Jeremiah B. lumber, 174 Plymouth avenue, house 176 do.
 Whitbeck Joanna D. widow, h. 60 Martin
 Whitbeck John F. physician, 93½ State, h. 18 Gibbs
 Whitbeck John W. physician, 18 Gibbs, b. do.
 Whitbeck Maggie A. teacher, Concord school, No. 18, boards 34 Delevan
 Whitbeck Orrin L. engineer, 23 W. Main, h. 45 Broadway
 Whitbeck Peter B. boatman, h. 7 Briggs' pl.
 Whitbeck Sarah J. Miss, house 34 Delevan
 Whitbeck Thomas H. clerk, bds. 75 Allen
 Whitbeck & Dobbs (*Frank C. Whitbeck and Seneca Dobbs*), wood yard, 205 E. Main
 Whitburn Harriet, domestic, bds. 15 Asylum
 Whitcomb Alonzo G. (*Whitcomb & Crouch*), Whitcomb House, h. do.
 Whitcomb Edwin E. physician, 128 State, house 74 South Union
 Whitcomb Truman H. salesman, 123 State, house at Albion
WHITCOMB & CROUCH (*A. G. Whitcomb and W. Crouch*), proprietors Whitcomb House, 110 E. Main.—See page 567
 White Abigail, widow, house 2 Maple place
 White Albert, finisher, 25 N. Water, house 14 Buchan park
 White Amelia, dressmaker, 12 Vine, h. do.
 White Andrew C. salesman, 103 State, house 134 Frank
 White Artemus T. carpenter, h. 44 Manhattan
 White Augustus, hairdresser, 192 W. Main, house 117 Allen [nolds
 White Bridget, widow, b. Strong n. Rey-
WHITE BROTHERS (*T. C., J. E. and C. W. White*), florists, Thurston near Chili road.—See page 583
 White Celia Miss, bds. 39 North St. Paul
 White Charles, tinsmith, 225 E. Main, bds. 21 Tappan
 White Charles C. engineer, h. 24 Delevan
 White Charles F. clerk, 36 State, b. North Clinton c. Atwater
 White Charles F. framemaker, 57 W. Main, boards 9 Centre park
 White Charles W. (*White Bros.*), Thurston n. Chili road
 White Charles W. deceased September, 1875
 White Clement A. supt. Citizens' Gas Co. b. Brackett House
 White Edmund C. tinsmith, 225 E. Main, boards 10 Broadway [12 Vine
 White Edward M. salesman, 73 E. Main, h.
 White Elwood, whitewasher, h. 2½ School a.
 White Frances, domestic, bds. Culver cor. Schanck avenue
 White Frances, widow, boards 68 Strong
 White Frank A. clerk, 36 State, house 96 N. Clinton
 White George, clerk, 28 W. Main
 White George, boards 10 Romeyn
 White Henry, laborer, boards 137 South av.
 White Henry C. bookkeeper, 7 N. Water, h. 147 West avenue [Plymouth av.
 White Henry E. lawyer, 45 Arcade, h. 215
 White Henry K. bookkeeper, Crescent Mills, house 40 Thompson
 White Irene, widow, house 4 Pitt
 White James, expressman, boards 11 Otsego
 White James, canvasser, bds. 11 Elizabeth
 White James C. conductor, Erie Railway, h. 96 Caledonia avenue [22 Alexander
 White James M. coal yard, 101 Whitney, b.
 White Jane W. widow, house 241 Exchange
 White John, blacksmith, Brown cor. Jones, house 37 Magne [house do.
 White John, foreman, Atwater c. N. St. Paul,

- White John, whitewasher, h. 104 Exchange
 White John B. teamster, house 11 Otsego
 White John E. (*White Bros.*), Thurston near Chili road, house do.
 White John R. agent, house 58 Spring
 White John T. laborer, h. West near canal
 White Julia A. Mrs. dressmaker, 28 Vose, house do.
 White Leopold, cartman, house 29 Wilder
 White Lewis E. carpenter, house 67 Orchard
 White Madame, mother superior, Academy of Sacred Heart, 2 Prince
 White Margaret, widow, b. 49½ Thompson
 White Margaret A. widow, house 99 Adams
 White Martha, deceased, 1876
 White Mary Mrs. boards 165 North avenue
 White Mot, painter, boards 21 Tappan
 White Nannie Miss, saleswoman, 52 State, boards 11 Fitzhugh
 White Patrick, agent, house 14 Weld
 White Paul, cigarmaker, h. 149 South av.
 White Perry G. carpenter, h. 18 Joslyn park
 White Peter, porter, Osburn House, house 36 Lake avenue
 White Randolph A. clerk, 7 West Main, h. Mt. Vernon av. near Caroline
 White Richard E. lawyer, 42 Arcade, bds. 246 Plymouth avenue
 White Robert, laborer, bds. 9 Caledonia av.
 White Robert C. wireworker, 121 State, bds. 24 Orange
 White Rodney J. painter, house 21 Tappan
 White Sarah J. Mrs. boards 52 Jones
 White Susan, washerwoman, h. 149 South av.
WHITE THEODORE C. physician, 21 South Clinton, and (*White Bros.*), h. do. —See page 583
 White Thomas, removed to Canandaigua
 White Thomas, hackman, house 19 Eagle
 White Thomas, wireworker, 79 State, boards 42 Frank
 White Thomas E. (*Hovey & White*), 65 Powers' bldgs. boards 31 Greig
 White Thomas P. boots and shoes, 118 West Main, house 152 West avenue
 White V. R. Gardiner, machinist, Brown's race near Furnace, house 30 Clifford
 White William C. clerk, 73 East Main, h. 32 Charlotte [186 Brown
 White William H. policeman, City Hall, h. 3
 White William M. machinist, Exchange opp. Glasgow, boards 42 S. Washington
 White Wm. W. reporter, 15 Exchange, h. 3 Linden [Olean, h. 85 Reynolds
 Whitehair Joseph, gardener, Frost av. corner
 Whitehair William, hackman, h. Thorn al.
 Whitehouse John, clerk, 125½ State, h. 125 University avenue
 Whitehouse John, cigar manuf. h. 88 Ontario
 Whitehouse Thomas, painter, 125½ State, h. 3 Conkey avenue [3 Conkey av.
 Whitehouse William, painter, 125½ State, b.
 Whitlock Frederick C. roadmaster, R. & S. L. R. h. 24 Favor [h. 35 Stone
 Whitlock William, millinery, 99 E. Main,
 Whiteley Charles W. naturalist, b. 109 Frank
 Whiteley Henry J. naturalist, b. 109 Frank
 Whiteley James E. naturalist, h. 109 Frank
 Whiteside Albert L. agent, 42 State
 Whitford Leander, prop. Globe Hotel, Lake avenue opp. Ridge road, house do.
 Whitford Leslie, tinsmith, 90 E. Main, house Wilcox near Monroe av.
 Whiting Addison N. & Son (*A. D. Whiting*), grocers, 260 E. Main, house do.
 Whiting A. Delafield (*A. N. Whiting & Son*), boards 260 East Main
 Whiting Chauncey, shoemaker, 111 State, h. Sellinger near St. Joseph
 Whiting George, removed to Ilion
 Whiting Marcellus B. filter maker, house 7 Franklin
 Whiting Samuel S. cook, house 78 Adams
 Whiting Wm. H. teacher, House of Refuge, boards 27 Emerson [260 E. Main
 Whiting Willis P. salesman, 44 State, boards
 Whitley Eliza, widow, house 9 Ontario
 Whitley Henry, carpenter, house 258 North
 Whitley James, painter, 128 North avenue, boards 9 Ontario
 Whitley John, house 4 Tappan
 Whitley John, insurance agent, 132 Powers' bldgs. boards 9 Ontario
 Whitley John P. bridge builder, Leighton avenue n. Goodman, h. 79 Weld
 Whitley Lizzie, widow, boards 246 North
 Whitley Rachel, boards 32 Davis
 Whitley Thomas, carpenter, house 212 North
 Whitley Thomas, machinist, house 32 Davis
 Whitley Thomas J. laborer, bds. 9 Ontario
 Whitley William, carpenter, bds. 9 Ontario
 Whitlock Geo. L. wood dealer, 225 North Clinton, house do.
 Whitman Mary, widow, bds. 49 Orchard
 Whitman Michael G. tool handler, 136 Mill, house 36 Warner [b. 50 S. St. Paul
 Whitmer Christopher, tinsmith, 90 E. Main,
 Whitmer Jacob, turner, 131 N. Water, house 25 German
 Whitmer Mary, widow, boards 63 Weld
 Whitmer Rudolph, painter, r. 120 Mill, bds. 62 Weld
 Whitmore Alonzo, laborer, house 1 Summer
 Whitmore Azel, car driver, house 1 Julia
WHITMORE, BRADY & CO. (*W. W. Whitmore, G. Brady and C. H. Rathbun*), stone yard, 54 Fitzhugh cor. Erie canal. —See page 653 [102½ East Main
 Whitmore Enos B. patents, 50 Arcade, house
 Whitmore E. J. widow, house 5 Summer
 Whitmore Harriet A. Mrs. h. 16 Elizabeth
WHITMORE, RAUBER & VICINUS, (*V. F. Whitmore, John Rauber and Wm. Vicinus*) stone yard, 175 S. St. Paul. —See page 659
 Whitmore Valentine F. (*Whitmore, Rauber & Vicinus*), 175 S. St. Paul, h. 47 Hickory
 Whitmore Wm. W. (*Whitmore, Brady & Co.*), house at Lockport [Delevan
 Whitney Adelbert, clerk, 73 E. Main, h. 42
 Whitney Chas. C. engineer, h. 36 North av.
 Whitney Cyrus W. clerk, 14 Exchange, b. 9 South Washington
 Whitney Elizabeth, b. East av. c. Alexander
 Whitney Edwin F. house 170 Frank
 Whitney George, carver, house 75 Smith

Whitney George J. grain elevator, Brown c. Erie canal, house 290 State
 Whitney George P. clerk, Platt cor. Kent, boards 107 Lake avenue
 Whitney James H. deceased Sept. 4th, 1875
 Whitney James M. house 107 Lake avenue
 Whitney James W. clerk, Brown cor. Erie canal, boards 290 State [house do.]
 Whitney Jane A. boarding house, 32 Stone,
 Whitney Jane A. Mrs. house 8 Joslyn park
 Whitney J. Eugene, clerk, 35 Arcade, bds. 8 Joslyn park [mouth avenue]
 Whitney John J. tinsmith, house 120 Plymouth
 Whitney Libbie E. artist, 81 East Main, bds. 120 Plymouth avenue
 Whitney Mary A. widow, h. 103 Tremont
 Whitney Matthias S. clerk, 121 West Main, house 99 Frank
 Whitney Nancy A. dressmaker, h. 99 Frank
 Whitney Peter, shoemaker, b. 103 Tremont
 Whitney Warham, clerk, city treas. office, City Hall, boards 107 Lake avenue
 Whitsell John C. carpenter, h. Flint c. Seward
 Whittaker Albert T. boards 12 North Water
 Whittaker Wm. teamster, boards 49 Scio
 Whittemore Charles S. removed to Boston, Mass.
 Whittemore Geo. H. prof. Roch. Theological Seminary, b. 57 East av.
 Whittier Edmund E. engineer, h. 30 Spencer
 Whittinger Frank, tailor, house 12 Wilder
 Whittlesey Ann, widow, house 90 Fitzhugh
 Whittlesey Franklin (*Scrantom & Co.*), scrap metals, Hunter c. Olean, h. 33 Tremont
 Whittlesey Frederick A. lawyer, 73 Powers' buildings, house 90 Fitzhugh
 Whittlesey Frederick C. (*Whittlesey & Weston*), 34 Plymouth av. h. 92 South Frances
 Whittlesey T. Weed, deputy county treasurer, Court House, bds. 90 Fitzhugh
 Whittlesey W. Seward, ass't postmaster, Arcade, house 30 Troup
 Whittlesey Zina, agent, boards 89 Alexander
 Whittlesey & Weston (*F. C. Whittlesey and W. G. Weston*), painters, 34 Plymouth av.
 Whybrew Samuel (*Whybrew & Backus*), 6 State, house 76 Monroe avenue
 Whybrew & Backus (*S. Whybrew and C. E. Backus*), managers Vacuum Oil Printing office, 6 State
 Whyland John L. tree agent, house 10 East
 Wibern John, builder, h. 18 Hamilton place
 Wichmann Charles J. (*Wichmann & Kallush*), boards 22 Caroline [Caroline]
 Wichmann Christina M. widow, house 22
 Wichmann Frederick, gardener, h. 4 Mt. Vernon avenue [Caroline]
 Wichmann Theodore J. carpenter, house 22
 Wichmann & Kallush (*C. J. Wichmann and C. Kallush*), clothing, 7 South avenue
 Wick Charles (*Boeman & Wick*), 90 Plymouth avenue, house 372 Brown
 Wick Henry, grocer, 274 Brown. house do.
 Wickens Philip, produce, 1 Lyell, house 20 Cypress
 Wickes Henry, clergyman, h. 46 Park avenue
 Wickes Robert B. student, b. 46 Park avenue
 Wickham Charles, deceased November, 1875

Wickham Frederick, nurseryman, house 325 N. Clinton [ft. Platt, h. 9 Hamburg
 Widdowson Albert (*H. and A. Widdowson*),
WIDDOWSON HENRY & A. machinists, ft. Platt, b. 100 East av.—*See page 671*
 Widemann John M. physician, 17 Nassau, house do. [h. Orchard c. Campbell
 Widenmann Charles B. tailor, 20 W. Main,
 Widener Peter, house 7 Glasgow
 Widman Charles F. cabinetmaker, Hydraulic buildings, house 8 Nassau
 Widman Christian, h. St. Joseph c. Herman
 Widman Ferdinand, mason, house 29 Nassau
 Widman John, shoemaker, 26 Herman, h. 22 do. [22 Herman
 Widman John F. shoemaker, 50 Front, bds.
 Widman J. Chas. grocer, 136 and 138 St. Joseph, house do. [h. 49 Campbell
 Widmer Frederick, carriage maker, 3 Canal,
 Widmer G. Adolph, painter, bds. 72 Adams
 Widmer Jacob, cabinetmaker, 133 N. Water, house 25 German [house 72 Adams
 Widmer Rudolph, tailor, 58 Smith's block,
 Widner Jacob, house 4 South Ford
 Widner Millard F. boards 4 South Ford
 Wiechmann Fred. saloon, 264 Brown, h. do.
 Wiechmann John F. cabinetmaker, boards 146 Jay [43 Lime
 Wiedeman Michael, cooper, 74 Whitney, h.
 Wiedemann Frederick G. nurseryman, Frost avenue cor. Olean, house 42 Bartlett
 Wiedeman Michael, nurseryman, Frost av. cor. Olean, house 56 Bartlett
 Wiegand Adam, house 85 Manhattan
 Wiegand Anthony (*F. and A. Wiegand*), 93 North Clinton, boards 118 East avenue
 Wiegand Caspar, shoemaker, 118 East av. house do. [house 69 Scio
 Wiegand Edward, shoe manuf. 7 S. St. Paul,
 Wiegand Frank & A. (*Anthony Wiegand*), cigar manufs. 93 N. Clinton, bds. 118 East avenue [42 Pearl
 Wiegand George, sashmaker, Fisk's bldg. h.
 Wiegand, see Weigand, and Wigand
 Wier John W. miller, h. North av. cor. Bay
 Wier Rebecca, nurse, boards 60 Concord av.
 Wier Samuel R. salesman, 17 State, house 141 Adams
 Wier Wm. bell boy, Osburn House
 Wieschemeyer Bernard, laborer, Platt cor. Kent, house 33 East Maple
 Wieschemeyer Edward, cabinet maker, bds. 33 East Maple
 Wieser Geo. saloon, 52 Allen, house do.
 Wiesler Conrad, market, 48 North av. h. do.
 Wiesner Adam, shoemaker, h. North av. n. Jennings [Jennings
 Wiesner Catharine, widow, h. North av. n.
 Wiesner John G. laborer, house 32 Herman
 Wiesner Joseph, baker, 45 Andrews, h. do.
 Wiesner Michael, sash and blinds, 231 Brown, house do.
 Wiest Anton, butcher, h. 153 Pinnacle av.
 Wiest August, mason, house 1 Weeger
 Wiest Martin, mason, house 39 Weeger
 Wietz August, teamster, house 22 Sellinger
 Wietz Charles, removed from city
 Wietz Jacob, peddler, house 6 Cayuga place

A. R. PRITCHARD & LIKLY,

SHAWL STRAPS,
 No. 78 STATE STREET.

- Wigand Peter, laborer, house 56 Sanford
 Wiggins James T. carpenter, b. 30 Frost av.
 Wiggins John, laborer, Exchange n. Troup,
 house 30 Frost avenue
 Wightman Dallas A. (*H. M. Moseely & Wight-*
man), 7 E. Main, b. E. Main n. Stillson
 Wigney Wm. B. groceries, 14 Jones, h. do.
 Wigton Melvin, bricklayer, h. 7 George's pk.
 Wihle Ann, widow, boards 31 Bond
 Wilber Charles C. printer, 3 W. Main, b. 6
 North Union
 Wilber Frederick, laborer, house 3 Webster
 Wilber Frederick jr. machinist, b. 3 Webster
 Wilberton Lawrence G. student, 21 S. Clinton,
 boards 68 S. St. Paul
 Wilbor Albert D. pastor, Cornhill Methodist
 Church, house 10 Tremont
 Wilbor Charles W. physician, 192 N. Clinton,
 house do.
 Wilbur Charles S. student, boards 85 Court
 Wilbur Edward T. jeweler, boards 4 Elm
 Wilbur Esek P. salesman, 53 E. Main, house
 185 N. St. Paul
 Wilbur Isaac E. landscape painter, 106
 Arcade, b. 14 Elm
 Wilbur Nathan P. prop. Farmers' Hotel, E.
 Main cor. Elm, house do.
 Wilbur Otis, carpenter, boards 3 Maple place
 Wilbur Thomas F. real estate, h. Farmers'
 Hotel
 Wilcox Chloe, widow, boards 3 Oak
 Wilcox Ezra L. watchman, Flour City Mills,
 house 46 Magne
 Wilcox Frederick H. removed from city
 Wilcox Frederick P. student, b. Monroe av.
 corner Wilcox
 Wilcox Henry B. deputy collector, custom
 house, 31 State, bds. National Hotel
 Wilcox John, agent, house 16 Lorimer
 Wilcox John R. stone cutter, 8 West av. h.
 Waverley near Julia
 Wilcox Otis N. 116 Powers' bldgs. h. Mon-
 roe av. c. Wilcox [h. at Fairport
 Wilcox Seymour G. lawyer, 60 Powers' bldgs.
 Wilcox Wm. J. bookstore, 150 State, house
 8 Oak [ington, h. at Deposit
 Wilcox W. R. salesman, Allen c. N. Wash-
 Wilcox Wm. W. painter, bds. 21 William
 Wilcox, see Willcox
 Wild Charles, grocer, 243 State, house do.
 Wild John, silver gilder, 38 Gorham, house
 Norton cor. Hollenbeck
 Wild Louis, painter, house 57 Chatham
 Wild Thomas, farmer, boards 51 Martin
 Wilder A. Carter, deceased, December, 1875
 Wilder A. Carter Mrs. house 48 East avenue
 Wilder Clarence, printer, boards 12 Tappan
 Wilder Edward J. hairdresser, 13 Exchange,
 house 9 Chatham [Vienna
 Wilder Edward M. carpenter, house Barth n.
 Wilder Ellen, widow, house 6 Warehouse
 Wilder Esther C. Mrs. dressmaker, 21 South
 avenue, house do. [12 Tappan
 Wilder Lafayette, printer, 23 W. Main, h.
 Wilder Louis De V. physician, 119 W. Main,
 house do. [204 Brown
 Wilder Lyman F. foreman, 116 Mill, house
 Wilder Nellie A. music teacher, b. 12 Tappan
 Wilder Samuel, vice-pres't Mechanics' Sav-
 ings Bank, 15 Exchange, house East av.
 corner Wilder place [South av.
 Wilder William A. cutter, 63 Mill, house 21
 Wilds Patrick, laborer, Gas Works, house 25
 Philander
 Wile Abraham, boards 31 Clinton place
 Wile Bros. & Co. (*I. & J. M. Wile and S.*
Stern), clothiers, 74 Mill [Clinton pl.
 Wile Emanuel, salesman, 54 Mill, boards 2
 Wile Gabriel & J. & Co. (*M. Brickner*), cloth-
 ing, 64 Mill, house 46 N. St. Paul
 Wile Henry G. student, University of Roch-
 ester, boards 46 N. St. Paul
 Wile Isaac (*Wile Bros. & Co.*), h. 18 Clinton
 place [bldgs. b. 18 James
 Wile Isaac A. (*Wile & Wile*), 12 Powers'
 Wile Isaac G. bookkeeper, 64 Mill, h. 46 N.
 St. Paul
 Wile Isaac J. clothier, house 9 Franklin sq.
 Wile Joseph, 74 Mill, house 35 N. Clinton
 Wile Julius (*G. & J. Wile & Co.*), h. 31 Clin-
 ton place [N. Clinton.
 Wile Julius M. (*Wile Bros. & Co.*), boards 35
 Wile Louis G. salesman, 64 Mill, b. 46 N. St.
 Paul [place
 Wile Myer L. salesman, 64 Mill, b. 2 Clinton
 Wile Rosanna, widow, house 2 Clinton place
 Wile Samuel, mens' goods, b. 71 N. Clinton
 Wile Solomon (*Wile & Wile*), 12 Powers' bldgs.
 boards 46 N. St. Paul [Powers' bldgs.
 Wile & Wile (*I. A. & S. Wile*), lawyers, 12
 Wilert Otto, blacksmith, house 2 Oakman
 Wiles Thomas, shoemaker, h. 24 Holland
 Wilford Edwin R. mason, boards 19 Hebard
 Wilford Jerry, pressman, boards 19 Hebard
 Wilforth David, mason, boards 19 Hebard
 Wilforth John A. mason, house 19 Hebard
 Wilforth Samuel, mason, house 13 Wait
 Wilhelm Christian, upholsterer, 74 State,
 boards Reed House
 Wilker Catharine, widow, boards 32 George
 Wilkin Andrew J. lawyer, 90 West Main, h.
 148 West avenue
 Wilkin George A. house 32 Kent
 Wilkin Elizabeth Mrs. nurse, bds. 42½ Lyell
 Wilkin T. Denton, student, 90 West Main,
 boards 148 West avenue
 Wilkins Andrew, clergyman, h. 13 Madison
 Wilkins Archibald C. student, Rochester
 Theological Seminary, bds. Trevor Hall
 Wilkins Charles, carpenter, b. 23 Phelps av.
 Wilkins Daniel, removed to Geneva
 Wilkins Edward, bridge builder, Railroad
 av. n. State, h. Litchfield cor. E. Maple
 Wilkins Frank L. student, bds. 13 Madison
 Wilkins Herve D. music teacher, 107 West
 Main, boards 10 Canal [ton n. North
 Wilkins Joseph, painter, 10 Front, h. Dray-
 Wilkins Sarah J. dressmaker, b. Litchfield
 corner East Maple [h. 62 Conkey av.
 Wilkins William H. gasfitter, 25 Exchange,
 Wilkinson Alvin, carpenter, house 16 Tyler
 Wilkinson Caroline R. teacher, Free Acad-
 emy, house 28 Fitzhugh [block
 Wilkinson Bella, dressmaker, h. 41 Sibley's
 Wilkinson Hiram, patternmaker, Mill corner
 Factory, house 7 Lorimer

HENRY C. WISNER,

THE CELEBRATED (SOLE AGENCY) "MOSELLE
WARE"---No. 33 STATE STREET.

Wilkinson Margaret, widow, h. 44 Griffith
 Wilkinson Margaret Mrs. boards 24 White
 Wilkinson Nicholas, house 7 William
 Wilkinson Richard J. gatekeeper, N. Y. C. depot, boards 15 Atwater [Tyler
 Wilkinson Stephen T. music teacher, b. 16
 Wilkinson William C. prof. Rochester Theological Seminary, boards Trevor Hall
 Wilkinson William H. machinist, Court cor. Stone, boards 44 Griffith
 Will Albert, removed from city
 Will Henry, brewer, boards 187 N. St. Paul
 Will Philip, Bartholomay Brewing Co. 139 North St. Paul, house 187 do.
 Willahan Isabella, tailoress, h. 82½ Lyell
 Willahan Lydia J. tailoress, bds. 82½ Lyell
 Willard Abigail, widow, h. 128 S. St. Paul
 Willard August jr. cabinetmaker, 73 State, house 20 West Maple [Paul, b. do.
 Willard Carrie B. dressmaker, 128 S. St.
 Willard Charlotte, widow, house Perkins corner Clarkson [73 Fitzhugh
 Willard Edward U. clerk, 55 West Main, b.
 Willard Luman B. carriagemaker, ft. Centre, boards 61 Oak
 Willard Lydia, widow, boards 25 Jones
 Willcox Horton, real estate, 37 Powers' bldgs. house 254 North St. Paul
WILLCOX & GIBBS Sewing Machine Co. 12 Allen.— See page 592
 Willets Manuel, house 42 North avenue
 Willett Electa Miss, boards 12 Chatham
 Willett Oscar D. clerk, 35 Exchange, h. 39 Frost avenue
 Willett Wm. hackman, h. 34 S. Washington
 Willey Ethan A. salesman, house 23 Troup
 Williams Abram G. carpenter, boards 43 Pinnacle avenue [house do.
 Williams Alfred, fancy goods, 230 E. Main,
 Williams Alfred C. cutter, 79 N. Water, bds. 58 Frank
 Williams Ann, widow, h. r. 29 Hill [ander
 Williams Annie M. cook, East av. c. Alex.
 Williams Andrew, shoemaker, 75 N. Water, boards St. Joseph near Norton
 Williams Arthur R. boards 66 Lake avenue
 Williams Asabel, kindling wood, 61 South Union, house 55 Savannah [Magnolia
 Williams Bridget Miss, boards Mansion near
 Williams Byron C. removed to Newark
 Williams Casterline, lawyer, 105 Powers' buildings, boards 15 Pleasant
 Williams Charles, tinsmith, 90 East Main, h. 40 Pearl [duct, boards 47 North
 Williams Charles A. bookkeeper, 5 Aqueduct
 Williams Charles E. clerk, 26 Allen, bds. 11 Centre park
 Williams Charles H. house 4 Franklin square
 Williams Charles M. removed to Brooklyn
 Williams Charles M. (*Pinning & Williams*), 86 Powers' bldgs. bds. 4 Franklin square
 Williams Charles M. spoke maker, 3 Elizabeth, boards 72 Broadway [Allen
 Williams Clarence, clerk, 61 State, bds. 43
 Williams Edward W. clerk, City Hall, b. 64 Fitzhugh [avenue
 Williams Elisha, boatbuilder, h. 43 Pinnacle
 Williams Eliza, widow, house 5 Denning

Williams Eliza A. Miss, b. 39 S. Washington
 Williams Elizabeth R. Mrs. house 43 Allen
 Williams Elliott M. laborer, 5 Aqueduct, h. 24 Warehouse
 Williams Evan R. agent, house 72 S. Union
 Williams Ezra, seeds, 52 N. Water, house 45 Fitzhugh
 Williams Frank, machinist, bds. 279 N. St. Paul [avenue
 Williams E. C. Mrs. widow, h. 79 Monroe
 Williams Fanny Mrs. music teacher, 63 Gregory [Bowen
 Williams Fanny E. nurse, East av. opposite
 Williams Frank W. painter, Mortimer c. N. Water, b. 143 E. Main [ter, b. 22 Asylum
 Williams Frederick M. foreman, 75 N. W.
 Williams Garner C. (*Williams & Co.*) 46 Exchange, house 22 Meigs [h. 63 Gregory
 Williams George, painter, 100 S. St. Paul,
 Williams George D. city treasurer, City Hall, house 33 Troup
 Williams Geo. F. salesman, 73 E. Main, bds. 43 Pinnacle av. [S. Clinton, b. 9 Comfort
 Williams George W. (*Swift & Williams*), 57
 Williams Grant, removed from city
 Williams Harvey D. (*P. Burke & Co.*), rear 204 State, house 47 Plymouth avenue
 Williams Henry, deceased November, 1875
 Williams Henry B. engineer, bds. 43 Allen
 Williams Henry C. watchmaker, 324 State, house 9 Jones avenue [96 E. Main
 Williams I. Eugene (*Williams & Jordan*), b.
 Williams James, laborer, boards 51 Munger
 Williams James B. salesman, 85 Exchange, house 4 Tracy park [bds. 30 Rhine
 Williams John, blindmaker, 13 Warehouse,
 Williams John, painter, bds. 14 North York
 Williams John, steamer, No. 3, b. 49 Front
 Williams John C. removed to Dansville
 Williams Joseph, trunkmaker, foot Rowe, b. St. Joseph near Norton
 Williams Joseph (*Williams & Managan*), 132 East Main, bds. East Main cor. East av.
 Williams Joseph, house 7 Spring
 Williams Joseph, fish dealer, house 18 Joiner
 Williams Joseph F. trunkmaker, foot Rowe, boards 46 Galusha [b. Congress Hall
 Williams Joshua S. sleeping car conductor,
 Williams Laura M. widow, bds. 4 Tracy pk.
 Williams Lizzie J. Miss, bds. 112 Monroe av.
 Williams Louis, blindmaker, 13 Warehouse, house 29 Rhine
 Williams Louis L. (*Williams & Rogers*), house 10 Jones avenue
 Williams Maggie Miss, house 33 Hill
 Williams Margaret, widow, house St. Joseph near Norton
 Williams Maria J. teacher, Atwater School, No. 10, boards 143 East Main
 Williams Martin, mason, boards 8 Mansion
 Williams Marvin, removed from city
 Williams Mary Mrs. boarding house, 143 E. Main
 Williams Mary, stitcher, boards 52 North av.
 Williams Mary A. widow, house 3 Plum al.
 Williams Mary E. widow, h. 14 North York
 Williams Mary S. Mrs. house 17 Hope
 Williams Michael, laborer, h. 131 Hudson

Williams Oscar F. teacher, Roch. Business University, boards 11 Centre park
 Williams Otto G. removed from city
 Williams Owen (*Stockbridge, Brayton & Co.*), 75 North Water, h. 17 Fitzhugh [bl.
 Williams Rebecca, widow, h. 24 Johnston's
 Williams Richard, h. 194 East Main [do.
 Williams Samuel, tobacconist, 97 Frank, h.
 Williams Samuel B. (*Williams & Bassett*), 85 Exchange, house 79 Meigs
 Williams Samuel S. removed to Buffalo
 Williams Simon, stonecutter, 8 West avenue, house 30 Rhine [56 Oakman
 Williams Stephen, trunkmaker, ft. Rowe, h.
 Williams Thomas, cooper, b. 72 Broadway
 Williams Thomas laborer, bds. 64 Exchange
 Williams Thomas H. carriage trimmer, 1 Lancaster, house 82 Joiner
 Williams Thomas H. foreman, 79 N. Water, house 38 Vienna
 Williams Walter C. clerk, 53 East Main
 Williams Wellington, painter, 14 Cliff, h. do.
 Williams Whitney, conductor, N. Y. C. R. R. boards 41 Frank
 Williams William, foreman, boiler shop, 138 Mill, house 55 Pearl
 Williams William jr. salesman, 16 Exchange, boards 55 Pearl [h. 23 W. Troup
 Williams Wm. carriage maker, 2 Mortimer,
 Williams Wm. agent, Roch. insole manuf. Co. 75 North Water, house 22 Asylum
 Williams Wm. (*Williams & Hoyt*), boards 15 Pleasant [16 Vienna
 Williams Wm. H. shoemaker, 79 N. Water, h.
 Williams Wm. shoemaker, h. 177 N. Clinton
 Williams Wm. B. clerk, 55 State, b. 43 Allen
 Williams Wm. J. H. blacksmith, boards 143 East Main [5 Franklin sq.
 Williams Wm. H. shoemaker, 111 State, b.
 Williams Wm. W. gatekeeper, N. Y. C. depot, boards 100 Mill
WILLIAMS & BASSETT (*S. B. Williams and W. T. Bassett*), oils, &c. 85 Exchange.—See page 680
 Williams & Co. (*G. C. Williams and J. Morwell*), stone dealers, 46 Exchange
 Williams & Hoyt (*W. Williams and C. E. Hoyt*), shoe manufs. 79 North Water
 Williams & Jordan (*I. E. Williams and E. E. Jordan*), printers, 96 East Main
 Williams & Managan (*J. Williams and E. J. Managan*), paper hangings, 132 E. Main
WILLIAMS & ROGERS (*L. L. Williams and F. E. Rogers*), Rochester Business University, West Main cor. Exchange.—See *Schools in contents*
 Williamson David F. clerk, 62 West Main, boards 45 Atkinson [Atkinson
 Williamson David M. collar maker, boards
 Williamson Edwin T. carpenter, house 114 Orchard
 Williamson Jane, widow, house 25 Campbell
 Williamson Joseph clerk, 75 State, boards 45 Atkinson
 Williamson Martin T. turner, 111½ North Water, boards Third near Rowe
 Williamson Richard, removed from city
 Williamson Richard, carpenter, b. 161 Brown

Williamson Richard, laborer, 22 West av. b. 54 Litchfield
WILLIAMSON RICHARD & W. builders, rear 8 Allen, h. 6 Smith.—See p. 588
 Williamson Robert S. bookkeeper, 62 West Main, boards 45 Atkinson
 Williamson Thomas, carpenter, Litchfield n. canal, house 161 Brown [h. 74 Walnut
 Williamson Walter (*R. & W. Williamson*), Williamson Wm. carpenter, bds. 74 Walnut
 Williamson Wm. shoemaker, 76 Caledonia avenue, h. 45 Atkinson [h. 15 Greig
 Williamson Wm. A. (*Williamson & Higbie*), Williamson W. Henry, dec'd Oct. 19, 1875
WILLIAMSON & HIGBIE (*W. A. Williamson and H. A. Higbie*), Powers' bldgs. book store, 62 West Main.—See page 518 [do.
 Willingham Wm. baker, 40 N. Union, h. 37
 Willis Ann, widow, boards 19 Hamilton pl.
 Willis Caroline M. widow, house 27 Adams
 Willis Edmund P. (*Hallowell & Willis*), 39 North Water, and (*J. E. Spencer & Co.*), house 49 Plymouth avenue
 Willis Isaac (*Hallowell & Willis*), 39 North Water, and (*J. E. Spencer & Co.*), house 64 Plymouth avenue
 Willis John, driver, boards 1 Summer alley
 Willis John, laborer, house Wolcott
 Willis Maria, widow, b. Plymouth av. cor. Strong
 Willis Martha, widow, boards 38 Lorimer
 Willoughby Sarah, widow, b. 160 N. St. Paul
 Willow William, laborer, house 98 Clifton
 Willsea Theodore, trimmer, 3 Canal, boards 80 West avenue
 Willson Marcus D. Mrs. widow, h. 275 North
 Willson Wallace A. clerk, 36 State, house 68 South avenue
 Wilmot Amos C. house 4 Goodman
 Wilmot Sarah D. widow, b. 196 Monroe av.
 Wilsey George, removed to Syracuse
 Wilson Albert, hairdresser, 34 Exchange, b. 105 Mill [av.
 Wilson Amanda C. widow, h. 143 Plymouth
 Wilson Arthur W. clerk, 119 E. Main, bds. 54 Monroe avenue [St. Joseph
 Wilson Augustine A. wheelmaker, bds. 280
 Wilson A. clerk, boards 54 Monroe avenue
 Wilson Bridget, widow, house 18 Seward
 Wilson Byron D. clerk, Post Office, boards 45 Hamilton place
 Wilson Charles, miller, 125 N. Water, b. 11 Lake avenue [b. 27 Alexander
 Wilson Clark H. bookkeeper, 153 E. Main,
 Wilson Cornelius, laborer, house 57 Gregory
 Wilson David A. tinsmith, 266 State, boards 80 Strong
 Wilson David C. (*Furley, Ferguson & Wilson*), Mill foot Brown, house 68 Frank
 Wilson David E. milkman, h. Huron n. Hudson
 Wilson Deborah A. Mrs. h. 25 Champlain
 Wilson Edward, foreman, Lake av. c. Champion, house 11 Bloss .
 Wilson Edward C. market, 42 Lake avenue, house 4 Spencer [Norton
 Wilson Edwin F. farmer, house Hudson near
 Wilson Eliza, widow, boards 104 Exchange

HENRY C. WISNER,

WHITE CHINA DINING and TEA SETS, No. 33 STATE STREET.

Wilson Elizabeth Mrs. milliner, 180 East Main, house do.
 Wilson Eri F. (*Wilson & Smith*), 196 Powers' buildings, boards 8 South Washington
 Wilson Erritta V. Miss, dressmaker, 1 Sibley block, house do.
 Wilson Frank, chairbottomer, h.218 W. Main
 Wilson Franklin E. T. boards Hudson near Norton [Ambrose]
 Wilson Federick C. Mrs. widow, boards 40
 Wilson Frederick J. miller, Ely Mills, bds. 27 Stone
 Wilson George, painter, boards 10 Foehner
 Wilson George, mason, house 80 Strong
 Wilson George (*Wilson & Pond*), house 4 W. Troup [Mt. Hope av.
 Wilson George 2d, (*Wilson & Pond*), house 59
 Wilson George W. real estate, h. 86 Hudson
 Wilson Hannah, widow, house 44 Sherman
 Wilson Henry, whitewasher, boards 18 Caledonia avenue
 Wilson Henry, carpenter, house 6 German
 Wilson Henry (*Wilson & Ashton*), 125 North Water, house 11 Lake avenue
 Wilson Henry, hides, 130 Front, house Norton n. N. St. Paul [Troup
 Wilson Henry A. miller, Model Mills, b. 4 W.
 Wilson Henry E. hay dealer, 38 Andrews, b. Franklin
 Wilson Henry F. salesman, 141 State
 Wilson Herbert, engineer, 3 Elizabeth, house 82 Platt
 Wilson Herbert J. book binder, 29 West Main, boards Norton near St. Joseph
 Wilson Herbert R. engraver, 18 State, bds. 4 North Washington [Hudson
 Wilson Hiram E. carpenter, house Huron n.
 Wilson James, coachman, bds. 111 Lake av.
 Wilson James, machinist, Clinton Mills, bds. 80 Strong
 Wilson James, laborer, house 19 Spring
 Wilson James, hostler, National Hotel, bds. 18 Market
 Wilson James & Co. (*J. Wilson jr. and C. F. Roberts*), Ely Mills, South Water, house 27 Stone [Water, boards 27 Stone
 Wilson James jr. (*James Wilson & Co.*), S.
 Wilson James A. trimmer, 3 Canal, house 119 Atkinson
 Wilson James H. boards 40 Ambrose
 Wilson James T. carpenter, 38 Andrews, b. 34 Franklin
 Wilson John, removed from city
 Wilson John, agent, boards 119½ East Main
 Wilson John B. carriage painter, 16 Market, house Rapids road near city line
 Wilson John H. wheel manuf. 3 Aqueduct, house 280 St. Joseph
 Wilson John H. county clerk, Court House, house 47 Lake avenue
 Wilson John S. house Norton n. St. Joseph
 Wilson John W. lawyer, 90 Powers' bldgs. boards do. [South Washington
 Wilson Louis, coachman, 23 Fitzhugh, h. 41
 Wilson Margaret, seamstress, house 13 Lind
 Wilson Martha, boards 24 Chestnut
 Wilson Martha C. widow, h. 119 Atkinson
 Wilson Mary, widow, h. 41 S. Washington

Wilson Mary, widow, house 1 Marshall
 Wilson Mary, stitcher, boards 18 Seward
 Wilson Olive R. Mrs. house 17 Eagle
WILSON P. STRONG, insurance agent, 1 Arcade, h. 144 West av.—*See page 508*
 Wilson Richard, laborer, Frost av. c. Olean, bds. Plymouth av. near Rapids
 Wilson Robert, dry goods dealer, boards 19 Fulton avenue
 Wilson Robert B. carpenter, house 35 Henry
 Wilson Samuel, agent, boards 7 Fitzhugh
 Wilson Samuel, laborer, h. 5 Tonawanda
 Wilson Samuel, removed from city
 Wilson Sarah Mrs. house 39 S. Washington
 Wilson Thomas, blacksmith, house 82 Sibley's block
 Wilson Thomas, land agent, house 114 State
 Wilson Thos. B. shoemaker, 75 N. Water, boards 78 Court
 Wilson Thomas J. carriage painter, 3 Canal, boards 119 Atkinson
 Wilson Wallace A. clerk, bds. 68 South av.
 Wilson Warner, coachman, b. 41 S. Washington [34 Franklin
 Wilson William, carpenter, 38 Andrews, h.
 Wilson William A. foreman, 138 Mill, house 442 Brown
 Wilson Wm. D. L. Rev. removed from city
 Wilson William H. shoemaker, b. 18 Seward
 Wilson & Ashton (*H. Wilson and T. Ashton*), millers, 125 N. Water
WILSON & SMITH (*E. F. Wilson and P. H. Smith*), dentists, 196 Powers' bldgs. —*See page 513*
 Wilson, see Willson
 Wilsonbach Joseph, cooper, house 77 Childs
 Wilsonbah John, gilder, house 34 Campbell
 Wilsons & Pond (*G. and G. Wilson 2d, and C. F. Pond*), millers, South Water
 Wimble Edwin P. clerk, 140 W. Main, bds. 90 Caledonia av. [h. 45 Oakman
 Wimble George, porter, Whitcomb House,
 Wimble James, porter, National Hotel, h. 90 Caledonia avenue
 Wimble James S. (*Lettington & Wimble*), 25 Exchange pl. h. 76 Cady [43 Adams
 Winans Ira, bookkeeper, 7 W. Main, house
 Winans Lewis, boards Clinton Hotel
 Winchell Reily, teamster, house 77 South av.
 Winchet Daniel W. clerk, 27 W. Main, bds. Farmers' Hotel [Jones, h. 62 Bolivar
 Winckworth Robert, machinist, Brown cor.
 Windover Mary, widow, h. 97 S. St. Paul
 Windsor Wm. laborer, City Hospital, b. do.
 Winfield Wm. F. plasterer, h. 92 W. Maple
 Winfield William J. (*Keeler & Winfield*), Mill cor. Exchange place
 Wing Charles, bds. Evergreen n. N. St. Paul
 Wing Charlotte Miss, house Evergreen near North St. Paul [10 West av.
 Wing Philip, moulder, 187 W. Main, boards
 Wing Robert H. laborer, house 21 James
 Wing William J. laborer, boards 21 James
 Wingate Mary Miss, boards 65 Meigs
 Wingate Wright, laborer, house 31 Atwater
 Wink John A. gardener, house Jennings n. North avenue
 Winkelman George, cooper, house 203 Scio

A. R. PRITCHARD & LIKLY,

GLOVES, CANES, ETC., A LARGE STOCK, No. 78 STATE STREET.

- Winkelman Geo. jr. blacksmith, h. 9 Davis
 Winn A. whip manuf. 23 Exchange, house
 35 William
 Winn Charlotte, deceased Dec. 15, 1875
 Winn Chester B. clerk, 23 Exchange, house
 35 William
 Winn Levi, hostler, r. 118 W. Main, h. do.
 Winn Nathaniel, house 65 East avenue
 Winna Charles, laborer, house 1 Clinton pl.
 Winnard Alexander, watchmaker, Court c.
 Stone, house 20 Broadway
 Winneur Joseph, laborer, house Henrietta
 avenue n. Pinnacle avenue
 Winneur Winfield, laborer, house Henrietta
 avenue n. Pinnacle avenue [alley
 Winney Hiram, street car driver, h. 8 Spring
 Winney Mary J. seamstress, 263 North St.
 Paul, boards do. [University av.
 Winsler Henry, clerk, 151 E. Main, boards 72
 Winsler James, deliverer, h. 74 University av.
 Winship Daniel W. clerk, 27 W. Main, bds.
 Farmers' Hotel [Fulton av.
 Winslow John M. house 10 Phelps avenue c.
 Winslow Lorenzo, boards 169 East Main
 Winstone Thursea C. domestic, b. 13 Meigs
 Winter Anthony, shoemaker, 87 N. Water,
 house Flower n. N. Clinton
 Winter Charles, tailor, h. 14 McDonald av.
 Winter Charles, laborer, house 34 German
 Winter Henry, grocer, 115 Pinnacle av. h. do.
 Winter Henry, removed to Germany
 Winter John, laborer, h. W. Orange n. Ames
 Winter Joseph, cutter, 68 Mill, h. 23 Hand
 Winter Simon, brewer, N. Clinton n. Clif-
 ford, b. N. Clinton n. Flower
 Winter William, tinsmith, h. 227 E. Main
 Winterroth Alfred (*Filkins & Winterroth*), 14
 Powers' bldgs. h. 36 Jones [St. Joseph
 Winterroth Sigmund, shoemaker, house 43
 Winters Bridget, skirts, 224 E. Main, h. do.
 Winters William C. ins. agent, house 110
 Monroe avenue
 Winterstein Robert E. (*W.D. McGuire & Co.*),
 8 Elwood block, house 19 Scio
 Winter John, clerk, 17 E. Main, house 250 E.
 Main [railroad, boards 91 Front
 Wintringer Antoine, laborer, Glasgow near
 Wire Sarah, widow, boards 165 State
 Wirley Benjamin, carriage trimmer, house
 109 Pinnacle avenue
 Wirley Frederick, harnessmaker, 121 State,
 house 182 Pinnacle avenue
 Wirley Mary, tailor, boards 34½ Grand
 Wirsching Gottlieb, cabinetmaker, 69 N. St.
 Paul, house 63 Scrantom
 Wirsing Frederick, carver, b. 63 Scrantom
 Wirth Adam, cabinetmaker, 123 Mill, house
 33 Oakman
 Wirth Catharine, widow, 15 Cayuga place
 Wirth Frederick, tailor, house 1 Oakman
 Wirth Henry, gluer, Hydraulic bldgs. house
 37 Oakman [St. Joseph n. Norton
 Wirth John, trunkmaker, foot Rowe, house
 Wirth Joseph, farmer, house Leighton av.
 near Goodman [n. Hudson
 Wirthheim John, grinder, 136 Mill, h. Clifford
 Wirtz William H. shoemaker, 44 Exchange,
 boards 35 N. St. Paul
- Wiseman Albine (*Townsend & Wiseman*),
 Andrews c. N. Water, h. 239 N. St. Pau
 Wiseman George P. machine operator, 73
 N. Water, house 18 Meigs [Jones
 Wisner Edward B. jeweller, 14 State, bds. 13
 Wisner Joseph, hackman, 55 N. Clinton, h. do.
 Wisgickl Thomas, shoemaker, 114 W. Main,
 house 77 Orange [33 E. Maple
 Wismeyer Edward, cabinetmaker, 2 Hill, b.
WISNER HENRY C. china, glass and
 crockery ware, 33 State, house 19 Arnold
 park.—*See foot lines through book*
 Wisner Minnie F. boards 19 Arnold park
 Wisse Peter, carpenter, house 9 Wadsworth
 Withall Carrie, bds. University of Rochester
 Withall Elijah, janitor, University of Roch-
 ester, house do. [University of Roch.
 Withall Judson J. printer, 1 Aqueduct, bds.
 Witherell Eliza A. widow, house 33 Cherry
 Witherell William, removed to Brockport
 Witherspoon Edward, lawyer, 25 North St.
 Paul, house do.
 Witherspoon Frank E. (*W. Witherspoon &*
Son), boards 38 Elizabeth
 Witherspoon Samuel F. bds. 25 N. St. Paul
 Witherspoon Wm. E. (*Goodrich & Withers-*
poon), 8 W. Main, h. 27 N. Washington
 Witherspoon Wm. & Son (*F.E. Witherspoon*),
 grocers, 106 W. Main, h. 38 Elizabeth
 Withey Frank C. deceased June, 1875
 Withey Mary, widow, house 31 Stone
 Witmer Frederick, carriagemaker, house 49
 Campbell [20 Wadsworth
 Witt Louis, machinist, Court cor. Stone, b.
 Witt Louisa, domestic, bds. 118 Alexander
 Wittman Catharine, widow, h. 139 W. Maple
 Wittman Christopher, shoemaker, house 54
 Orange
 Wittman George, laborer, boards 52 Orange
 Wittman Isadore, dyer, h. Ames n. W. Maple
 Wittman Jacob, market, 286 Brown, house
 38 Wilder
 Wittman John, turner, boards 52 Orange
 Wittman William, laborer, 215 State, bds.
 Orchard n. Lime
 Wittmann Leonard, butcher, Spencer c. Sara-
 toga avenue, boards do. [Paul
 Wittwer Christian, tinsmith, bds. 50 S. St.
 Witzel Ambrose, booterimper, 7 S. St. Paul,
 house 27 Hand
 Witzel Conrad, laborer, h. Henrietta avenue
 near Allmeroth
 Witzel Elizabeth Mrs. tailor, h. 48 Chatham
 Witzel Henry, stone cutter, 22 West avenue,
 house Magnolia near Frances
 Witzell Augustus, baker, 262 State, h. do.
 Witzell Elizabeth E. tailor, b. 66 Hickory
 Witzigman Caspar, shoemaker, Webster n.
 North, house 173 North
 Witzigman Joseph, hairdresser, Webster n.
 North, house 6 Mark
 Witzigman Julia, widow, h. St. Joseph near
 Norton [bds. do.
 Witzigman Lena Miss, saloon, 173 North,
 Witzigman Matthias, deceased August, 1875
 Wixted Hugh, saloon, 145 W. Main, h. do.
 Wozzack Adolph, cigar maker, 88 S. St.
 Paul, house do.

HENRY C. WISNER,

REAL AND FRENCH BRONZES,
No. 33 STATE STREET.

Woczack Mary Mrs. cigar manufacturer, 88 S. St. Paul, house do.
 Woehrlen Adolph G. cabinet maker, Exchange cor. Court, b. 30 Franklin
 Woehrlen Edward W. harnessmaker, 65 State, house 79 N. Clinton
 Woelfel Charles, teacher, St. Joseph's school, boards 18 Franklin
 Woellert August, deceased March 19, 1876
 Woellert Charles A. cabinet maker, 133 N. Water, bds. 91 Kelly
 Woellert Mary, widow, house 91 Kelly
 Woelpe John, printer, 149 N. Water
 Wohlfahrt John, sole cutter, 111 State, house Bernard n. Thomas
 Wohlfart Joseph M. provisions, 222 North Clinton, house do.
 Wohlrab John, stone cutter, Oak c. Smith, house 33 W. Maple
 Wohlgenuth Wm. physician, Glenwood av. n. Third, h. do.
 Wohlrab John, stone cutter, Oak cor. Smith, house 33 W. Waple
 Wohlrab Max, stone cutter, 8 West avenue, house 27 Whitney
 Wolcott Anson F. & G. P. distillers, east end Clarissa st. bridge, h. 121 Mt. Hope avenue
 Wolcott Clark, teamster, h. Whitney c. Lime
 Wolcott Eva M. dressmaker, b. 73 Hickory
 Wolcott George P. (*A. F. & G. P. Wolcott*), house 122 Mt. Hope av. c. Clarissa
 Wolcott Jas. E. clerk, east end Clarissa st. bridge, house 26 Hickory
 Wolcott John A. clerk, 58 State, boards 143 East Main
 Wolcott J. Willis, bartender, 54 West avenue, house 83 do. [house do.
 Wolcott Mary Miss, furrier, 22 Clarissa
 Wolcott Oscar T. cartman, b. 62 Exchange
 Wolcott Sarah Miss, dressmaker, 22 Clarissa, house do.
 Wolcott Sarah Mrs. widow, bds. 26 Wilder
 Wolcott —, milliner, bds. 180 State
 Wolf Adam, driver, bds. 116 West avenue
 Wolf Andrew, cooper, 5 Charles, h. Campbell near Ames
 Wolf Anna, widow, house 69 University av.
 Wolf Calman, chairmaker, house 4 Pryor
 Wolf Chas. laborer, h. Jennings n. North av.
 Wolf Chas. G. saloon, 78 Pinnacle av. h. do.
 Wolf Edward, shoemaker, boards. 38 Platt
 Wolf Frank, carpenter, house 21½ Scrantom
 Wolf Frank jr. carpenter, bds. 21½ Scrantom
 Wolf George, tailor, boards 21½ Scrantom
 Wolf George, cabinetmaker, Jay c. Erie canal, boards 164 Jay
 Wolf George, cigar maker, 21 Front, boards 50 South St. Paul
 Wolf George, boards 24 William
 Wolf John E. tobacconist, 21 Front, h. do.
 Wolf John W. varnisher, 69 N. St. Paul, b. 69 University avenue
 Wolf Joseph, lamp maker, 3 Canal, house 77 Campbell
 Wolf Joseph, mason, house 16 Scrantom
 Wolf Joseph A. tinsmith, 97 St. Joseph, b. 21½ Scrantom

Wolf Joseph A. bartender, 39 Andrews, b. 105 North Clinton [h. 22 Hand
 Wolf Louis, cabinetmaker, 69 N. St. Paul,
 Wolf Margaret, laundress, h. 48 N. Clinton
 Wolf Myer V. peddler, house 5 Hanover
 Wolf Michael, policeman, City Hall, house 164 Jay
 Wolf Michael jr. watchman, house 24 Lime
 Wolf Peter, foreman, house Jay n. Childs
 Wolf see Wolf, Wolff and Wulff
 Wolfe William P. foreman, 124 Front, house 30 Hudson [5 Lowell
 Wolfer George, brewer, 139 N. St. Paul, h.
 Wolfer William, cooper, house 84 Platt
 Wolferman Caspar, laborer, h. 9 Caspar
 Wolff Abraham B. agent, h. 147 N. Clinton
 Wolff Felix & Co. (*C. Main*), hides and pelts, 29 N. Water, h. 53 Chatham
 Wolff Jacob P. laborer, h. 30 St. Joseph
 Wolff Nathan H. agent, boards 3 Oakman
 Wolff Wm. (*Rice & Wolff*), 49 Mill, boards 71 North Clinton
 Wolff Wm. carpenter, 193 N. Clinton, h. do.
 Wolford Andrew, pulp maker, pulp mills, N. St. Paul, Middle Falls, h. 26 Martin
 Wolford Joseph A. removed to N. Y. city
 Wolkow John, laborer, h. r. Hudson near Norton
 Wollenberg Christopher F. peddler, house Hague near Railroad
 Wollenhaupt Chas. baker, Brackett House, house r. 35 St. Joseph
 Wollenhaupt Conrad, tailor, b. 54 Wilder
 Wollenhaupt Ernst, tailor, house 54 Wilder
 Wollenhaupt Frederick, tailor, b. 54 Wilder
 Wollenhaupt Wm. C. removed to Germany
 Wolf Abraham E. broker, 72½ Powers' bldgs. b. 29 N. St. Paul
 Wolf Babette, widow, h. 29 N. St. Paul
 Wolf Elias, deceased October, 1874
 Wolf Martin E. clerk, 5 Powers' bldgs. b. 29 N. St. Paul
 Wolf Wm. E. deceased August 28, 1875
 Wolohan James, foreman, 44 Exchange, h. 131 Brown [131 do.
 Wolohan Louis P. bartender, 135 Brown, b.
 Wolslager Jacob, laborer, h. Bay n. Goodman
 Wolter Moritz, mason, boards 9 Champion
WOLTERS CHARLES F. watches, &c. 30 W. Main, house 6 South Clinton.—
See page 577
 Wolters see Walters
 Wolz Anthony, removed to Chicago, Ill.
 Wolz Crescentia, widow, house 104 Saxton
 Wolz Frank, removed to Chicago, Ill.
 Wolz Mary F. widow, house 26 Campbell
 Wolz Mary T. milliner, 26 Campbell, b. do.
 Wolz Sebastian, carpenter, b. 173 Brown
 Wolz William, cigar maker, 48 Exchange, h. 106 Wilder
 Wombwell Alfred, laborer, h. ft. Tremont pl.
 Wombwell James, laborer, house Frost av. near Sumner
 Women's Christian Temperance Union Eating House, 8 East Main
 Woman's Temperance Lunch Rooms, 89 State
 Wondergem Henry J. varnisher, 22 S. St. Paul, house 6 Huntington

- Wondes August, filer, 120 Mill
 Wooby Porter, hostler, r. 117 W. Main, h. do.
 Wood Alfred W. shoemaker, 4 Allen, house
 2 Munger [boards Clinton Hotel
 Wood Andrew J. steam heating, 11 Exchange,
 Wood Anna, confectioner, 121 N. St. Paul,
 house do.
 Wood Bridget, milliner, boards 71 Scio
 Wood Caleb J. teacher dancing, 10 $\frac{1}{2}$ Mum-
 ford, house at Fairport [Delevan
 Wood Charles, foreman, 77 N. Water, b. 61
 Wood Daniel, lawyer, 24 Arcade, h. 42 Court
 Wood David E. carpenter, Minerva alley,
 house 25 Clarissa
 Wood Edward, plasterer, b. Centre c. Mill
 Wood Elijah L. physician, 32 South St. Paul,
 house 28 South avenue
 Wood Eliza, widow, boards 30 South
 Wood Elizabeth C. widow, b. Richards cor.
 Boardman
 Wood Elizabeth, widow, house 58 Asylum
 Wood Frank H. Miss, copyist, 114 Powers'
 bldgs. boards 36 Madison
 Wood Hannah, deceased, April 1, 1876
 Wood Henry G. patternmaker, 187 W. Main,
 h. 440 Brown [n. W. Main, h. do.
 Wood Hiram, European Hotel, Fitzhugh
 Wood Isaac, clerk, 76 Front, b. York House
 Wood James, engineer, N. Y. C. R. R. bds.
 Congress Hall
 Wood James, carpenter, house 71 Scio
 Wood James S. machinist, boards 3 Pitt
 Wood James T. shoemaker, 77 N. Water, b.
 61 Delevan
 Wood Jennie, seamstress, h. 56 Sibley's block
 Wood Jewel, dressmaker, h. 56 Sibley's block
 Wood John, dresser, 25 N. Water, boards 28
 Olean [26 Julia
 Wood John, stonecutter, 8 West avenue, h.
 Wood John C. fireman, house 3 Pitt
 Wood John T. machinist, b. r. 166 Ply-
 mouth avenue
 Wood John Z. artist, 7 Market, boards 10
 Chestnut
 Wood Joseph S. carpenter, b. is. 45 S. Union
 Wood Luton, house 36 Madison
 Wood Marcus M. shoemaker, Andrews cor.
 N. Water, house 121 North St. Paul
 Wood Martha, widow, house 2 Mumford
 Wood M. E. shoe manuf. 77 N. Water, h. 33
 Court
 Wood Richard B. shoe manuf. 77 N. Water,
 house 33 Court [b. 61 Delevan
 Wood Samuel A. shoemaker, 77 N. Water,
 Wood Seymour G. dentist, 89 East Main, h.
 14 Comfort
 Wood Silas, removed from city
 Wood Stephen, teacher, h. 45 South Union
 Wood Thomas J. sup't Leighton bridge and
 iron works, Leighton av. h. 313 E. Main
 Wood Walter, farmer, h. Culver n. Schenck
 avenue
 Wood William H. carpenter, h. 115 Clifton
 Wood William H. shoemaker, h. 61 Delevan
 Wood William H. salesman, h. 14 Charlotte
 Wood William L. music teacher, 36 Madi-
 son, boards do. [mouth avenue
 Wood William O. C. mason, h. 168 $\frac{1}{2}$ Ply-
 Wood Wm. R. clerk, 24 Arcade, b. 42 Court
 Wood, see Woods [ington
 Woodbeck Mary, widow, h. 39 S. Wash-
 Woodbeck Thomas, scavenger, h. 90 Tremont
 Woodbury Anna, widow, house 30 N. Union
 Woodbury Betsey, widow, h. 6 W. Troup
WOODBURY, BOOTH & PRYOR (D.
A. Woodbury, J. E. Booth and H. H.
Pryor), steam engine and boiler builders,
Mill near Platt.—See page 687
 Woodbury D. A. (*Woodbury, Booth & Pryor*),
 house 76 Lake avenue
 Woodbury Edmund F. (*Strong & Woodbury*),
 Allen cor. N. Washington, h. 49 Lake av.
 Woodbury Eliza A. teacher, Genesee School,
 No. 4, boards 6 West Troup
 Woodbury John C. clerk, b. 49 Lake avenue
 Woodbury Jonathan, house 43 Lake avenue
 Woodbury Marcus K. (*Woodbury, Morse &*
Co.), 7 W. Main, house 6 Stillson
 Woodbury Mary Mrs. h. Union near Monroe
WOODBURY, MORSE & CO. (M. K.
Woodbury, H. H. Morse and J. Smith),
paints, oils, &c. 5 W. Main.—See p. 625
 Woodbury Walker S. boards 77 North av.
 Woodbury Willis E. student, b. 76 Lake av.
 Woodcock Abram H. K. foreman, 15 West
 Main, b. 37 University av. [av.
 Woodcock Ames J. peddler, h. 37 University
 Woodcock George A. car driver, boards 37
 University avenue
 Woodcock Philip R. (*Stewart, Woodcock &*
Co.), 15 W. Main, h. 5 Selden
 Woodcock Sarah E. Miss, stitcher, boards 37
 University avenue
 Wooden Charles D. physician, 347 State, h. do.
 Wooden Clarence A. carpenter, b. 104 Sum-
 mer
 Wooden Eugene B. carpenter, b. 104 Summer
 Wooden Lodowick M. lawyer, 108 Powers'
 bldgs. house 5 Genesee [Union
 Wooden Ransom L. carpenter, h. 73 South
 Wooden Wm. B. carpenter, h. 104 Summer
 Woodhall William, deceased, Aug. 4, 1875
 Woodhams Julius H. papermaker, paper
 mill, house 6 Clarkson
 Woodhouse Anna, dressmaker, b. 68 Allen
 Woodland James, clerk, 121 E. Main, bds. 8
 James [block
 Woodruff Amelia, dressmaker, h. 8 Schleyer's
 Woodruff Clark C. Rochester Adamantine
 Brick Co. 5 Masonic block
 Woodruff Curren, boards 16 Elm
 Woodruff Reuben, boards 19 Gardiner park
 Woodruff Samuel R. grocer, 93 East av. h.
 19 Gardiner park
 Woodruff Sarah R. removed to Michigan
 Woodruff Thomas, machinist, Brown cor.
 Jones, house 174 Brown
 Woodruff Wm. S. clerk, 93 East av. bds. 19
 Gardiner park
 Woods Edward J. mason, boards 44 Asylum
 Woods Eliza J. Mrs. house 18 Mathews
 Woods Elizabeth, removed to Rush
 Woods George, peddler, h. Magne n. Lyell
 Woods Jane, domestic, boards 39 William
 Woods John, tanner, boards 12 N. Water
 Woods John W. tea, 3 Sibley's blk. h. do.

Woods Samuel, mason, house 24 Henry
 Woods Thomas, mason, 44 Asylum, h. do.
 Woodward Caleb R. bookkeeper, 110 Front,
 house Evergreen pk. n. Clifford
 Woodward Charles E. salesman, b. 16 Kent
WOODWARD CHARLES W. pictures,
 looking glasses, &c. 126 State, house 29
 Sophia.—See page 532
 Woodward Eunice C. widow, house 16 Kent
 Woodward Homer H. lawyer, 1 Baker's blk.
 house 155 West avenue
 Woodward Ida F. artist, boards 16 Kent
 Woodward Ira C. salesman, boards 16 Kent
 Woodward Mary E. nurse, 20 Park avenue
 Woodward Oscar D. salesman, bds. 16 Kent
 Woodward Roswell, salesman, 11 Front, h.
 5 South avenue [h. 56 State
 Woodward Warner C. salesman, 126 State,
 Woodworth Albert C. engineer, Trowbridge
 n. canal, h. 122 Atkinson [Broadway
 Woodworth Alfred P. machinist, boards 124
WOODWORTH CHAUNCEY B. & SON
 (C. C. Woodworth), perfumers, 113 West
 Main, h. 13 S. Washington.—See page 668
 Woodworth Chauncey C. (C. B. Woodworth &
 Son), h. 44 East av. cor. Gibbs
 Woodworth Daniel N. boards 89 Bartlett
 Woodworth William S. removed from city
 Wool Abner B. agent, 73 East Main, house
 8½ Chestnut [h. 45 Chestnut
 Woollard John, boots and shoes, 51 E. Main,
 Woolworth Orin J. clerk, 6 Exchange, bds.
 68 South St. Paul
 Wooster George, cooper, house 13 Tyler
 Wooster Mary G. widow, house Goodman n.
 Harvard
 Wootton Alfred, tinsmith, bds. 29 Rowley
 Wootton John, tinsmith, 97 East av. house
 29 Rowley
 Wootton Nellie, sewing, boards 29 Rowley
 Wootton Peter, laborer, removed from city
 Wootton Sarah, widow, boards 29 Rowley
 Wootton Thomas, mason, house Goodman n.
 Monroe avenue
 Worcester David F. real estate, 37 Powers'
 bldgs. house 125 Monroe avenue
 Worcester Harriet, widow, house 6 Gregory
 Wordell John H. policeman, City Hall, h.
 21 Pearl
 Worden James H. nurseryman, h. 30 South
 Worden Samuel C. dining rooms, 36 West
 Main, h. at Buffalo [b. 17 Marshall
 Work Charles P. student, University of Roch.
 Work Henry L. student, boards 17 Marshall
 Worsley Helen M. widow, h. 31 Reynolds
 Worsley Orville R. deceased July 15, 1875
 Worth Peter, shoemaker, h. Lyell n. Childs
 Worthington Philona, vestmaker, house 7½
 Orange
 Wortman David, painter, house 15 John
 Woulf Edward, shoecutter, 55 Mill, boards
 38 Platt [N. St. Paul
 Wray Elijah M. (Wray & Elwood), house 184
 Wray Henry jr. (Henry Wray & Son), house
 44 Troup
WRAY HENRY & SON (Henry Wray jr.),
 brass founders, 109 Mill, house 45 Adams.
 —See page 672

Wray Louise E. widow, house 31 Clifton
 Wray & Elwood (E. M. Wray and A. Elwood),
 locksmiths, 34 Mill
 Wrenn Martha Mrs. house 11 Glasgow
 Wright Adeline, widow, house 12 St. Clair
WRIGHT ALFRED, perfumery manuf.
 149 State, house 10 Centre park.—
 See page 593 [10 Centre pk.
 Wright Alfred G. perfumer, 149 State, bds.
 Wright Allison, painter, 9 West Main, house
 24 Weld
 Wright Alonzo, student, b. 68 S. St. Paul
 Wright Augustus, clerk, boards 32 Sherman
 Wright Caroline R. widow, h. Frost av. n.
 Olean [Water, b. 7½ W. Smith
 Wright Charles T. box maker, 111½ North
 Wright Charlotte, widow, bds. 77 S. Union
 Wright Daniel D. clerk, 57 State, b. 50 Troup
WRIGHT DANIEL W. & CO. (W. R.
 Peters and W. R. Craig), shoe manufac-
 turers, 73 N. Water, house West avenue
 near Hague.—See page 578
 Wright Eliza A. deceased Feb. 16, 1876
 Wright Elizabeth, widow, house Henrietta
 avenue near Pinnacle av.
 Wright Elizabeth, widow, bds. 38 Spencer
 Wright Ellen, washerwoman, house 1 Pine
 Wright Eugene B. carpenter, bds. 9 Wood-
 ford place [School No. 5, b. 8 Jones
 Wright Frances V. Miss, teacher, Central
 Wright Frank S. boards 10 Clinton place
 Wright Frederick, painter, bds. 102 Mill
 Wright George, grocer, 60 Adams, house do.
 Wright George, carriagemaker, 3 Elizabeth,
 house 117 Meigs [7½ Smith
 Wright George, millwright, 127 Mill, house
 Wright George W. miller, boards 7½ Smith
 Wright Harriet Miss, dressmaker, boards 7
 Briggs' place
 Wright Helen S. widow, house 10 Gibbs
 Wright Henry, miller, 35 N. Water, boards
 7½ Smith
WRIGHT ISAAC N. livery stable, 17 Di-
 vision, b. 14 N. Clinton.—See page 602
 Wright James, plasterer, boards Champlain
 near York
 Wright James A. machinist, Court c. Stone,
 house East avenue cor. Lawrence
 Wright James D. deputy sheriff, boards 146½
 West Main [240 State
 Wright John, foreman, Mill c. Factory, bds.
 Wright John, carpenter, h. 18½ Lancaster
 Wright John jr. clerk, Post Office, h. 9 Tappan
 Wright John C. plumber, 57 State, boards 50
 Troup [place
 Wright John S. perfumery, house 10 Clinton
 Wright John W. perfumery, 149 State, house
 61 Court
 Wright Julia A. stitcher, bds. 8 Fulton av.
 Wright Lucinda, widow, b. West av. n. Ames
 Wright Lucy, widow, boards 8 Pearl
 Wright Maria F. Mrs. dressmaker, 45 An-
 drews, house do.
 Wright Mary Ann, widow, house 50 Troup
 Wright Philemon, removed from city
 Wright Rachel, dressmaker, b. 3 Warehouse
 Wright Richard, carpenter, 29 Upton park,
 house do.

- Wright Samuel, canvasser, b. 32 Sherman
 Wright Samuel, laborer, bds. 121 S. St. Paul
 Wright Silas A. brakeman, bds. 39 Madison
 Wright Thomas, painter, 34 Plymouth av.
 boards 102 Mill
 Wright Thomas, truss hoop maker, rear 62
 East avenue, house 15 Lawrence
 Wright Thomas & Co. (*B. B. Flagler*), nur-
 serymen, 167 S. St. Paul, h. 4 Conkey av.
 Wright Thomas S. marble cutter, 122 South
 St. Paul, h. 77 Scio [bds. 75 do.
 Wright William, butcher, 79 Caledonia av.
 Wright William, carpenter, house 80 Troup
 Wright William, 62 East Main, house 52
 Edinburgh [house do.
 Wright Wm. A. whitewasher, 71 Chatham,
 Wright William B. removed to Buffalo
 Wright William H. carpenter, 111½ North
 Water, house 3 Seward
 Wrigley John, laborer, house 2 Cliff
 Wroath Lucinda, housekeeper, 21 West av.
 boards do. [near Berlin
 Wueyckhuise Abraham, farmer, h. Hudson
 Wulff Julius, printer, 23 West Main, h. 121
 West Maple [versity avenue
 Wulle Henry C. cutter, 70 Mill, bds. 43 Uni-
 Wulle Philip, tailor, house 43 University av.
 Wuschleger Frederick G. grocer, 184 West
 Main, house do.
 Wunch Anthony, teamster, house 5 Lincoln
 Wunch Elizabeth, boards 5 Lincoln
 Wunder Jacob, laborer, h. 232 St. Joseph
 Wunder John B. tailor, boards 28 Herman
 Wunder Matthias, tailor, house 28 Herman
 Wunders August, filer, boards 33 Rauber
 Wunders Daniel, blacksmith, h. 33 Rauber
 Wunsch Anthony L. teamster, North av. cor.
 Franklin, house 5 Lincoln
 Wunsch Charles, mason, h. 19 Huntington
 Wunsch John, laborer, house 253 North
 Wurtz Frederick, saloon, 228 State, h. do.
 Wurtz Frederick jr. bookkeeper, 109 State,
 boards 228 State
 Wyckoff Johanna R. widow, h. 96 Hunter
 Wyckoff John A. cutter, house 143 Frank
 Wygant Alvira, widow, house 44 Vienna
 Wyker Frederick, house 99 Scio
 Wykhuize Adrian N. tailor, h. 25 Goodman
 Wykhuize Cornelius A. telegrapher, 34 Ar-
 cade, boards 25 Goodman
 Wyman George W. removed to Geneva
 Wyron Charles, gardener, 29 Allen, bds. do.
 Wysard Louis, clerk, 54 Lyell, h. 70 West
- XAVIER MARY, Sister of Mercy, 5 South
 Xavier Sister, superior, St. Mary's Orphan
 Boys' Asylum, West av. cor. Genesee
- YACK FRANCES, widow, house 37 E. Maple
 Yack Mary Miss, stitchee, boards 37 E. Maple
 Yackel Frederick, tailor, house 12 Pitt
 Yaack Margaret, tailoress, boards 25 Grand
 Yaeger Leopold, laborer, house Alphonse
 near Hudson [70 W. Maple
 Yager Andrew, cooper, Magne n. R. R. house
 Yager A. Eugene, boards 17 Matthews
 Yager Henry, moulder, 20 Court, boards 96
 South St. Paul
- Yager, see Jager [144 Campbell
 Yaggi Jacob, carriagemaker, 3 Canal, house
 Yakel Charles, gilder, bds. 170 N. Clinton
 Yakel Jacob, cutter, 106 State, house 170
 North Clinton
 Yaky Charles W. boards 67 North Clinton
 Yaky Christian, house 67 North Clinton
 Yaky Christian, farmer, house Culver near
 Webster road [178 E. Main
 Yale Charles E. lawyer, 92 Powers' bldgs. h.
 Yale Emily, widow, boards 51 Court
YALE T. B. & CO. Brighton Nurseries,
 East av. beyond city line.—*See page 559*
 Yaman John, brewer, 120 Jay, boards do.
 Yaman Joseph, brewer, 120 Jay, house do.
 Yanneck Henry A. laborer, house 27 Vienna
 Yanneck Herman J. laborer, bds. 27 Vienna
 Yanney David, house 249 North St. Paul
 Yarker Charles P. salesman, 53 East Main,
 house Lake avenue near city line
 Yarton Edward, carpenter, 159 State, h. 130
 Pinnacle avenue
 Yates Agnes Ann, artist, boards 53 Scio
YATES ARTHUR G. wholesale coal deal-
 er, 28 West Main, house 97 Fitzhugh.—
See page 600
 Yates Charles (*Lavis & Yates*), 7 Julia, house
 15 Davis
 Yates Chas. F. carpenter, house 119 Adams
 Yates Elizabeth A. widow, house 53 Scio
 Yates George, plasterer, boards 54 West av.
 Yates Henry, house 124 Adams
 Yates Louisa, widow, boards 66 Clifton
 Yates Russell B. bookkeeper, 28 W. Main, b.
 97 Fitzhugh [h. 48 Alexander
 Yattau Geo. W. clerk, 2 Corinthian Hall bldgs.
 Yattau M. Mrs. billiards, 2 Corinthian Hall
 bldgs. house 48 Alexander
 Yauch Andrew, carpenter, house 55 Ontario
 Yauch Jacob, painter, bds. 18 University av.
 Yauch John, hat manuf. 20 Elwood block,
 house 30 Pinnacle avenue
 Yauchzi George, scroll sawyer, Hydraulic
 bldgs. house 133 Hudson
 Yauchzi John, house 48 Hanover
 Yauman Theodore, house 15 East avenue
 Yawman Edward C. baker, b. 103 Caledonia
 avenue
 Yawman Geo. grocer, Jay c. Orchard, h. do.
 Yawman John, cigarmaker, b. 103 Caledonia
 avenue [road near Goodman
 Yawman Nicholas, laborer, house Webster
 Yawman Philip, bakery, 101 Caledonia av.
 house 103 do. [Stone, h. 16 Lawrence
 Yawman Philip H. machinist, Court corner
 Yeackle Jacob, shoemaker, 111 Lyell, h. do.
 Yeares George, shoemaker, 83 North Water,
 house 73 Cypress [Jones avenue
 Years Elizabeth, widow, house Frank corner
 Yehle Frank, cabinetmaker, 133 N. Water,
 house 56 Hollister [4 Wilder
 Yehle Martin, laborer, Brown cor. Jones, h.
 Yekel Albert, mason, h. Mt. Vernon av. n.
 Cayuga place
 Yeoman George F. (*Satterlee & Yeoman*), 53
 Powers' bldgs. bds. Oregon cor. Atwater
 Yeoman Matthew, grocer, 74 West av. h. do.
 Yeoman Terence, saloon, 1 Plymouth av. h. do

- Yeomans Edward M. confectionery, 141 E. Main, house do.
- Yerkes Silas A. h. 3 Ambrose [b. 3 Ambrose
- Yerkes William H. lawyer, 56 Powers' bldgs.
- Yernst Henry, cabinetmaker, 7 N. Water, b. Mt. Vernon av. near Cayuga place
- Yestlein George, carpenter, h. 24 Bartlett
- Yocher Jacob, mason, house 49 Ontario
- Yocher Mary J. widow, b. Lyell n. Whitney
- Yokel Charles, cutter, Mumford c. Mill, h. 23 Scrantom [West York
- Yonson Henry, cigarmaker, b. North York c.
- Yont George, laborer, house 1 Hollister
- York Catharine Miss, laundress, b. 101 Adams
- YORK JOHN H.** city scavenger, 22 Gregory, house do.—See page 619
- Yorkey Charles, deceased, June 1875
- Yorkey David, tailor, house 15 Wilder
- Yorkey David H. carriage painter, 3 Canal, boards 17 Wilder
- Yorkey Frederica, widow, house 2 Herman
- Yorkey Nicholas, flagman, Dean st. crossing, house 15 Wilder
- Yorkey Tryphena, widow, boards 12 Rome
- Yorkey Wm. A. stove mounter, 20 Court, b. 15 Wilder [h 154 Scio
- Yorkey Wm. H. driver, Exchange c. Court,
- Yoss Frederica, widow, b. 4 Mt. Vernon av.
- Yost Charles H. (*Close & Yost*), 2 E. Main, house 5 Dover
- Yost Charlotte Mrs. waiting woman, N. Y. C. depot, house 18 Delevan
- Yost John, clerk, boards 18 Delevan
- Yotcy Adam W. blacksmith, h. 46 Lowell
- Yotcy Philip G. whipmaker, Allen n. North Washington, boards 48 Hanover
- Yotcy, see Yauchzi [Orange near Saxton
- Young Adam, cutter, Mill c. Mumford, h.
- Young Alfred, wood yard, 45 Monroe av. h. Monroe av. cor. Wilcox
- Young August, laborer, house Jennings near North avenue [line
- Young Caroline, tailorress, boards 34 Caroline
- Young Caroline J. widow, bds. 15 Alexander
- Young Charles, optician, 179 N. St. Paul, b. 5 Hollister
- Young Charles (*Young & Pasch*), h. 53 Kelly
- Young Chas. dry goods, 62 Monroe av. h. do.
- Young Charles A. shoemaker, 79 N. Water, house Nichols near Jennings
- Young Charles A. T. axle maker, house 53 Strong [Caledonia av.
- Young Charles C. salesman, 8 Hill, house 14
- Young Charles F. shoemaker, bds. 53 Kelly
- Young Charles H. shoemaker, 91 N. Water, boards 56 Front
- Young Chauncey, commission agent, house 48 Sophia [Trowbridge n. canal
- Young Conrad, laborer, 30 West av. house
- Young Edward, shoemaker, 87 N. Water, b. St. Joseph c. Catharine
- Young Edward, shoemaker, bds. 25 Munger
- Young Eliza, stitchee, bds. 44 Sanford
- Young Ella E. teacher, Concord School, No. 18, boards 44 North avenue
- Young Ellen, widow, boards 31 Tappan
- Young Frank B. Mrs. house 13 Ontario
- Young Frederick, laborer, h. Mt. Vernon av.
- Young Frederick, blacksmith, Favor n. West avenue, house 118 Chatham
- Young Fred. W. student, b. 14 Caledonia av.
- Young Geo. F. painter, house 17 Linden
- Young Geo. H. clerk, 136 Mill, b. North c. Channing
- Young Geo. M. removed to Philadelphia, Pa.
- Young Gottlieb, house Mt. Vernon avenue
- Young Gottlieb, laborer, b. 1 Mt. Vernon av.
- Young G. Wright, removed to Chicago, Ill.
- Young Henry, blacksmith, 10 S. Water, h. 7 Childs
- Young Henry (*Vroman & Young*), h. 95 Weld
- Young Henry, boards 6 Marshall
- Young Henry A. butcher, house 31 Tappan
- Young Jacob, moulder, 20 Court, h. 5 Hollister
- Young Jacob, hairdresser, Market c. Front, house 136 Jay [house do.
- Young Jacob, harnessmaker, 72 Monroe av.
- Young James, laborer, h. 5 Alexander [field
- Young James, laborer, Hill n. Ford, h. 5 Litch-
- YOUNG JAMES A.** ornamental plasterer, 51 S. St. Paul, boards 129 Alexander.—See page 647
- Young James K. P. painter, h. Mansion n. Violetta [Fulton av.
- Young Jay, boxmaker, 111½ N. Water, h. 11
- Young John, shoemaker, boards 78 Weld
- Young John, laborer, house 67 Gregory
- Young John, grocer, 64 Troup, house do.
- Young John N. carpenter, house 34 Asylum
- Young Joseph, machinist, Brown c. Jones, house 44 Platt
- Young Joseph, shoemaker, 4 Tonawanda, h. do.
- Young Joseph, finisher, 110 Front, b. 16 East avenue [Washington
- Young Joseph F. clerk, 44 State, bds. 4 N.
- Young Lawrence, removed to Columbus, O.
- Young Lewis, carpenter, house Channing n. North [Hollister
- Young Louis, tinsmith, 74 North av. bds. 5
- Young Lovisa, compositor, 23 W. Main, bds. 154 Exchange
- Young Martin, hairdresser, Front c. Market, house 55 Lancaster [Comfort
- Young Martin V. insurance agent, house 27
- Young Mary A. domestic, b. East avenue n. Goodman
- Young Mary J. vest maker, house 172 State
- Young Mary R. widow, house 25 Wilder
- Young Minnie Mrs. boards 153 S. St. Paul
- Young Morean, sawyer, Jay, c. Erie canal, house 30 Kelly
- Young Ozro N. laborer, h. Mansion n. Violetta
- Young Philip, boot fitter, house 297 Jay
- Young Robert, carpenter, house 36 Jay
- Young Simon, sawyer, Jay c. canal, boards 297 Jay [h. 40 Chatham
- Young Thomas, G. bookkeeper, 1 Aqueduct,
- Young Wm. cartman, house 91 Tremont
- Young Wm. cabinetmaker, boards 297 Jay
- Young Wm. B. baker, 197 Monroe av. h. do.
- Young Wm. D. foreman boards 85 Cady
- Young Wm. D. sawmaker, 153 State, house 60 Kent
- Young Wm. G. b. 60 Kent [grocers, 53½ Kelly
- Young & Pasch (*C. Young and J. F. Pasch*),
- Young, see De Jonge

Youngblood Joseph, stone moulder, boards 2 Centre
 Younger Charles F. tailor, house 53 Cady
 Younger Lena, domestic, boards 12 Park av.
 Young Johan Christian, baker, h. 59 Chatham
 Younglove Caroline, widow, h. 32 East av.
 Youngman Albert, tailor, 14 Mumford, bds. 80 Chatham
 Youngman Anthony J. hairdresser, 1 Corinthian Hall, boards 161½ West Main
 Youngman Gottlieb, cutter, 70 Mill, house 80 Chatham
 Youngman Valentine. trimmer, 46 Mill, bds. 80 Chatham
 Youngs Jennie Miss, boards 102½ E. Main
 Youngs Joseph, shoemaker, bds 16 East av.
 Yount Geo. laborer, h. Hollister n. Clifford
 Youst Christopher, laborer, h. 34 W. Maple

Zabel Charles, baker, 240 N. Clinton, bds. do.
 Zaches John, tailor, 290 Brown, house do.
 Zahn Henry, laborer, house 48 Caroline
 Zamel Louis, laborer, house 138 St. Joseph
 Zander Frederick, laborer, b. 22 Wadsworth
 Zander John, tailor, h. Foehner n. Hudson
 Zapf Charles, moulder, 187 W. Main, boards 5 Galusha [5 Galusha
 Zapf John G. moulder, 187 W. Main, house
 Zapf Magdalene, widow, house 5 Galusha
 Zapf Margaret, widow, house 16 Almira
 Zapf Valentine, laborer, house 108 Hunter
 Zapf Valentine jr. shoe cutter, Andrews cor. N. Water, boards 108 Hunter
 Zarges Mary, domestic, b. 58 Monroe avenue
 Zarges Otto (*Fünzer & Zarges*), 13 S. Water, house Barth near Vienna [Walnut
 Zauner Anton, blacksmith, h. Orange cor.
 Zeeveld Alfie, widow, house 15 Pleasant
 Zeeveld John, painter, 74 State, house 47 Goodman [Amity
 Zegewitz J. Adam (*Zegewitz & Fischer*), h. 1
 Zegewitz & Fischer (*J. A. Zegewitz and W. Fischer*), market, 132 East Main
 Zeiger Louis, cigarmaker, 48 Exchange, h. 110 Atkinson
 Zeigler Margaret Miss. tailoress, b. Hawkins near Oakman [near Oakman
 Zeigler Mary A. Miss. tailoress, b. Hawkins
 Zeiner Charles R. boxmaker, 3 Aqueduct, house 24 Mark
 Zeiner David G. laborer, h. Henry n. Clifford
 Zeiner Jacob, laborer, 111 Mill, h. 55 Tyler
 Zeislein Geo. (*Barth & Zeislein*), 69 N. St. Paul, house 95 St. Joseph [Hudson
 Zeller Catharine, widow, b. Alphonse near
 Zeller Emil, hairdresser, Hudson c. Clifford, house do. [W. Maple
 Zeller Jacob J. shoecutter, 4 Allen, bds. 35
 Zeller Michael, shoemaker, h. 35 West Maple
ZELLWEGER BROTHERS (*J. Conrad Zellweger jr. and John Zellweger*), embroidery stamping, 117 W. Main.—See page 544 [Grape
 Zellweger John (*Zellweger Bros.*), house 37
 Zellweger J. Conrad, embroidery stamping, house 154 Brown [37 Grape
 Zellweger J. Conrad jr. (*Zellweger Bros.*), b.
 Zemminger John, laborer, house 62 Smith

Zendler Christian, carriage painter, 3 Canal, house 135 St. Joseph [13 Moore
 Zengel John, sashmaker, 3 Aqueduct, house
 Zebernich John, laborer, house Huntington
 Zern Otto, removed to Germany
 Ziegfeld Julius A. agent, house 10 Bartlett
 Ziegler Benjamin, clerk, 72 W. Main, boards 156 N. St. Paul [h. 110 Orchard
 Ziegler Christopher, shoemaker, 246 State,
 Ziegler Frederick, mason, h. 47 St. Joseph
 Ziegler Frederick E. salesman, 14 W. Main, house 156 North St. Paul
 Ziegler Frederick H. porter, 72 Mill, boards 156 North St. Paul [near Frances
 Ziegler Frederick J. carpenter, bds. Hunter
 Ziegler Henrietta, seamstress, boards 156 N. St. Paul [boards 65 Chatham
 Ziegler Henry C. machinist, Court c. Stone,
 Ziegler Jacob, tobacconist, Mill c. Factory, house 65 Chatham [near Norton
 Ziegler John, gardener, house North avenue
 Ziegler John, shoemaker, 30 Franklin, house Hawkins near Oakman [110 Orchard
 Ziegler John E. newsboy, N. Y. C. R. R. b.
 Ziegler John jr. gardener, b. North av. near Norton [Oakman
 Ziegler Julius, hairdresser, b. Hawkins near
 Ziegler Louis, mason, h. Hunter n. Frances
ZIEGLER L. & CO. pump auger and
 pump rimmer manuf. foot N. Water n. R. R. h. 12 McDonald av.—See page 673
 Ziegler Magdalene Mrs. boards 101 Wilder
 Ziegler Margaret, widow, bds. 103 Chatham
 Ziegler Wm. J. lithographer, 7 Market, h. rear 9 Kelly
 Ziegner Philip, nurseryman, house 41 King
 Ziems Frederick, safemaker, h. 68 Lowell
 Ziems Joachim, safemaker, house 24 Rhine
 Ziems John, laborer, house 15 Wait
 Ziems John, b. 18 Rhine [boards 49 Lime
 Zieres George, blacksmith, 194 West Main,
 Ziervogel Charles, laborer, house 48 Kelly
 Ziezer Charles, mason, house 204 North
 Zimmer Frank, glassblower, 178 Plymouth avenue, house Champlain near Frances
 Zimmer Joseph G. clerk, 236 Brown, bds. 73 Frances
 Zimmer Margaret, widow, house 73 Frances
 Zimmer Dan'l, boarding house, 116 N. Water
 Zimmer John, tailor, 16 W. Main, house 15 Herman [69 Chestnut
 Zimmer Adam, market, 78 Monroe av. bds.
 Zimmer Catharine, market, 39 Monroe av. h. 69 Chestnut
 Zimmer Charles, clerk, 108 East av. bds. do.
 Zimmer Conrad F. grocer, 111 Mt. Hope av. house do. [boards 69 Chestnut
 Zimmer Conrad W. butcher, 39 Monroe av.
 Zimmer Frederick (*Pfeffer & Zimmer*), 122 West Main, house 22 Galusha
 Zimmer Frederick, h. 93 Chatham [Chatham
 Zimmer Frederick, clerk, 84 Atwater, bds. 93
 Zimmer Frederick & Co. (*C. F. Huber*), hay and grain, 78 Front, h. 146 Mt. Hope av.
 Zimmer Fritz, butcher, house 22 Galusha
 Zimmer George, market, 119 N. Clinton, h. do.
 Zimmer George, tailor, 79 State, boards 132 West Main

Zimmer George 2d, butcher, boards 5 Mt. Hope avenue [84 Stone
 Zimmer Henry, fireman, N. Y. C. R. R. bds.
 Zimmer Henry, shoemaker, h. 16 Galusha
 Zimmer Henry H. market, 152 North av. h. do
 Zimmer Henry & W. (*William Zimmer*),
 grocers, 84 Atwater, bds. 93 Chatham
 Zimmer John, house 119 North Clinton
 Zimmer John F. clerk, 171 Plymouth avenue,
 boards 24 Bartlett [bds. 5 Andrews
 Zimmer Peter, carriagemaker, 31 Mumford,
 Zimmer Wm. market, 13 Frances, b. 12 S.
 Ford [Pinnacle avenue
 Zimmer William (*H. & W. Zimmer*), bds. 99
 Zimmer William, wagonmaker, 11 Mt. Hope
 avenue, house 5 do. [14 Edward
 Zimmer William C. clerk, 31 Front, house
 Zimmer William W. fireman, N. Y. C. R.
 R. house 44 Rhine [lilton place
 Zimmerle Rudolph, blacksmith, h. 71 Ham-
 Zimmerman Christian, brewer, 106 Lake av.
 boards do. [N. Union
 Zimmerman Clement, shoemaker, house 97
 Zimmerman Frank, carver, boards 49 Wilder
 Zimmerman Frederick C. watch maker,
 Court cor. Stone, house 22 Savannah
 Zimmerman George, brewer, Colvin corner
 Syke, house do. [h. do.
 Zimmerman George, saloon, 78 St. Joseph,
 Zimmerman Hiram L. clerk, 23 Front, bds.
 28 Atkinson [h. 48 St. Joseph
 Zimmerman John, market, 54 N. Clinton,
 Zimmerman John, clerk, 81 State, house 28
 Atkinson [14 Hoeltzer
 Zimmerman Louis, hostler, 159 State, boards
 Zimmerman Mary, widow, house 49 Wilder
 Zimmerman Michael, brewer, Colvin, b. do.
 Zimmerman Michael, scavenger, h. 7 Cole
 Zimmerman Peter, stove repairer, house 31
 Baden [West avenue
 Zinck Philip, butcher, 163 W. Main, bds. 10
 Zinck Theodore, butcher, 99 N. Clinton, b. do.
 Zink Eugene, carpenter, b. 139 N. St. Paul
 Zink Frances, widow, house 111 St. Joseph
 Zink Frederick, stonecutter, h. 46 Hanover
 Zink Frederick W. cabinet maker, house
 Henry near Clifford [St. Joseph
 Zink Henry, printer, 18 N. St. Paul, h. 111
 Zink Stephen, tailor, house 95 Smith
 Zipke Charles, tinsmith, 90 E. Main, boards
 12 North Clinton [av. b. do.
 Zipke Emil, sawyer, island west of Mt. Hope
 Zipke John, sawyer, island, Mt. Hope av. h. do.
 Zipkey Charles, machinist, h. 114 Orchard
 Zitz Joseph, mason, house Vernon park
 Zoberbier Gustavus A. shademaker, 53 State,
 house 102 Kelly [30 Scramton
 Zoberbier Otto, carpenter, 22 S. St. Paul, b.
 Zoberbier Richard, upholsterer, 53 State, b.
 30 Scramton [Railroad al.
 Zoerner Charles jr. cabinet maker. boards 9
 Zoerner Charles, shoemaker, 48 West av. h.
 9 Railroad alley
 Zohn Mary, widow, house 14 Railroad alley
 Zoller Abram, removed to Hammond
 Zoller Charles C. upholsterer, 1 North av.
 boards 16 Tappan [h. 16 Tappan
 Zoller Daniel, blacksmith, Platt cor. Kent,

Zoller Darius, saddle maker, 1 Walbridge's
 block, house Fourth near Glenwood av.
 Zoller Jacob, stove mounter, 20 Court, bds.
 23 Tappan [b]k. h. 20 Lake av.
 Zoller Jacob, saddle manuf. 1 Walbridge's
 Zoller John B. machinist, house 72 Martin
 Zonneville Isaac, removed from city
 Zonneville John H. painter, house 283 St.
 Joseph [seph, bds. 283 do.
 Zonneville John M. shoemaker, 45 St. Jo-
 Zonneville Michael, laborer, Court n. River,
 boards 50 Savannah
 Zorn Charles, h. Ames n. R. R. [Orchard
 Zorn Christopher, tailor, boards Orange cor.
 Zorn Frederick, carpenter, house 120 Saxton
 Zorn John, chairmaker, bds. Avenue D near
 North St. Paul [h. 78 Martin
 Zorn Joseph, wood moulder, 22 S. St. Paul,
 Zorn Sarah A. paper hangings, 15 Front, h.
 avenue D [avenue D
 Zorn William, shademaker, 15 Front, house
 Zorsch Frank jr. tobacconist, 104 N. Clinton,
 house do.
 Zoyer Alois, mason, b. 94 N. Clinton [Front
 Zuber John, saloon, Mill cor. Market, h. 91
 Zuelk August, laborer, house 30 Catharine
 Zugelder Frank J. painter, boards 7 Munger
 Zugelder Fred. G. stonecutter, b. 7 Munger
 Zugelder George J. marble cutter, 122 South
 St. Paul, house 19 Munger
 Zugelder John L. stonecutter, bds. 7 Munger
 Zugelder Leonard, boat builder, h. Ashland
 Zugelder Leonard jr. stone cutter, 54 Fitz-
 hugh, boards Ashland near Gregory
 Zugelder Mary A. h. 7 Munger [h. 4 Hickory
 Zugelder M. Joseph, pressman, 82 W. Main,
 Zum Christopher, cutter, 14 Mumford, bds.
 138 Orange [University avenue
 Zurbregg Peter, coachman, house Prince c.
 Zurn Frederick, cabinet maker, 2 Hill, house
 Orchard near Orange
 Zurn Mary, stitcher, b. Orange cor. Orchard
 Zurn Minnie, vestmaker, h. Huron n. Scio
 Zwack Frank, tailor, house 138 W. Maple
 Zwack George, blacksmith, 16 Market, bds.
 128 West Maple [128 W. Maple
 Zwack Joseph G. blacksmith, 16 Market, b.
 Zwack Michael, wheelwright, 16 Market, h.
 128 West Maple
 Zwandoch Henry, laborer, house 20 Hanover
 Zweifel Jacob, blacksmith, h. 24 Prospect
 Zweige George L. boiler maker, Platt near
 Jones, house 26 Whitney
ZWEIGLE JOHN G. sausage maker, 45
 Front, house do.—*See page 553*
 Zweigle William, clerk, 45 Front, house
 26 Nassau [house 67 Weld
 Zweisig Charles, carpenter, 21 Minerva al.
 Zweisig Joseph, grocer, 98 Scio, house do.
 Zwerger Felix, cooper, 51 Pinnacle av. h. do.
 Zwerger John, mason, boards Clifford near
 N. Clinton [Clifford n. N. Clinton
 Zwerger Joseph (*Zwerger & Mattern*), house
 Zwerger & Mattern (*J. Zwerger and G. Mat-
 tern*), carpenters, Clifford n. N. Clinton
 Zwick William (*A. Boss & Co.*), 76 North av.
 house 16 Tappan
 Zwierlein Barbara, widow, house Ackerman

ROCHESTER BUSINESS DIRECTORY.

Advertising Agency.

DISBROW M. H. 29 W. Main (See back cover)

Agents.

ADVERTISING.

DISBROW M. H. 29 W. Main (See back cover)

COLLECTING.

Albee H. C. 23 Powers' bldgs.
Henry S. M. 36 Arcade
THOMAS G. W. 109 Powers' bldgs.
(See page 511)

EMIGRATION.

MAURER GEO. C. 78 E. Main (See page 595)

INSURANCE.

AMSDEN C. T. & SON, Powers' buildings (See page 505)
Annis C. 5 Powers' buildings
Baker J. E. 47 Troup
BRECK GEO. 22 Exchange (See page 509)
Buell & Levet, 22 Exchange
BUSH D. W. 8 Exchange place (See page 503)
DeVoll A. P. 33 Arcade
Elwood Geo. M. 55 West Main
Former Chas. J. 8 Powers' buildings
Gardner A. 32 Arcade
GORDON A. J. 18 W. Main (See page 506)
Graham Jas. J. 28 Powers' buildings
HOLMES W. F. & CO. 2 Masonic blk.
(See page 510)
HULETT A. I. 45 Powers' buildings (See page 506)
Manning & Gibbard, 122 Powers' bldgs.
Marr John, 35 East avenue
McLEAN & JOHNSON, 27 Arcade (See page 509)
Miller J. C. & Son, 39 Powers' bldgs.
MONTGOMERY W. H. 13 Powers' buildings (See page 510)
Moore J. W. 19 Powers' buildings
Moore W. T. 102 East Main
Parsons A. C. 92 Powers' bldgs.
PIERCE N. A. 41 Arcade (See page 508)
Raymond S. B. & Son, 31 W. Main
REIBLING & OLCOTT, 62 E. Main (See page 510)
ROBERTS G. HENRY, 6 Elwood blk. (See inside front cover)
Robinson S. R. 85 Powers' buildings
Rosenthal I. 26 Morris

ROWLEY & HAYES, 8 State (See page 505)

Sheldon O. L. 27 Arcade
Smith E. C. 45 Powers' buildings
Smith J. M. 5 Powers' buildings
Stark H. P. 18 East Main
STOWELL C. L. 132 Powers' bldgs.
(See page 504)
Swift Zenas M. 101 Powers' bldgs.
Taylor Wm. 22 Exchange
TYLER C. M. 40 East Main (See page 510)
Vay R., W. Main c. Fitzhugh
Vose F. 52 Arcade
WARD L. A. & L. F. 2 and 4 Exchange place (See page 502)
WARD & CLARK, 31 Powers' bldgs.
(See page 509)
Warner Wm. 18 Arcade
Webb C. H. 9 Powers' buildings
Wehn L., Roch. Savings Bank bldg.
WELCH & FIRMAN, 12 Smith's blk.
(See page 506)
WILSON P. S. 1 Arcade (See page 508)

LOAN.

Ward L. A. 2 Exchange place

MERCANTILE.

BRADSTREET J. M. & SON CO.,
W. F. BALKAM, supt. 28 and 30
Arcade (See front cover)
DUN R. G. & CO., C. C. OWENS,
manager, 15 Exchange (See p. 692)
McKILLÖP JOHN & CO. (commercial), 6 State (See page 507)

PATENTS.

Loughborough W. S. 44 Arcade
Osgood R. F. 49 Arcade
Parsons B. F. 92 Powers' buildings
Whitmore E. B. 50 Arcade

PENSION.

Mudge W. R. 59 Powers' buildings

REAL ESTATE.

Allyn Lewis, 16 East avenue
Arnold William E. 30 Meigs
Bancker John, 163 East Main
Bennett William M. 42 Arcade
Brown H. 115 Hudson
Campbell G. G. 50 Chestnut
Candee H. O. 56 Arcade
Culver J. Z. 42 Arcade
DEVENPORT & TUTTLE, 33 Arcade (See page 509)
Davis C. A. 37 Powers' buildings
Fairchild H. S. 59 Powers' buildings
Fullam & Copeland, 14 Smith's block

Ganyard H. O. 41 Arcade
 Holmes Edgar, 55 Powers' buildings
 Hyde Charles, 36 Arcade
 Kingsley & Brothers, 92 Powers' bldgs.
 Lamberton A. B. 37 Powers' bldgs.
 MABBETT A. L. 32 Arcade (*See front colored page*)
 Merriman M. H. 42 Arcade
 Palmer W. L. 50 Arcade
 PIERCE N. A. 41 Arcade (*See p. 508*)
 Porter S. D. 27 Arcade
 Rundel M. W. 57 West Main
 Snell Wesley, 3 Front
 UPTON C. H. 22 Smith's block (*See page 586*)
 Willcox H. 37 Powers' buildings

TICKET AND TRANSPORTATION

Allen William, 164½ State
 AMSDEN C. T. & SON, Powers' bldgs. (*basement*), (*See page 505*)
 BILLINGS E. G. 4 State (*Erie Railway*), (*See Railroads in Contents*)
 Coombs J. C. 88 Mill
 Darling W. S. 92 Mill,
 Embry F. W. 83 State
 FELL A. (*Blue Line*), 166 State (*See Railroads in Contents*)
 Fish & Heath, Fitzhugh corner Canal
 HARRIS B. F. (*Erie*), 4 State (*See Railroads in Contents*)
 HOYT WM. B. (*Canada Southern*), 100 Railroad av. (*See Railroads in Contents*)
 HOYT WM. E. (*Canada Southern*), 100 Railroad av. (*See Railroads in Contents*)
 Lee U. D. 92 Mill
 LESLIE WM. H. (*G. W. and M. C. R. R.*), 164 State (*See Railroads in Contents*)
 LEWIS R. S. (*G. W. and M. C. R. R.*), 95 Waverley blk. (*See Railroads in Contents*)
 MAURER GEORGE C. 78 East Main (*See page 595*)
 Schofield George, 92 Mill
 STETTHEIMER, TONE & CO. 8 State (*See page 501*)
 WARD L. A. & L. F. (*Inman line*), 2 Exchange place (*See page 502*)

Agricultural Tools.

DEALERS.

HAMILTON & MATHEWS, 21 W. Main (*See page 630*)
 KINGSLEY H. A. & CO. 112 East Main (*See page 631*)
 Marsellus H. W. 151 W. Main
 McBride & True, 134 East Main
 McMAHON & HAGAMAN, 159 W. Main (*See page 587*)
 POLLOCK, WEAVER & CO. 17 W. Main (*See page 631*)

MANUFACTURERS.

Carter Giles, 10 South Water
 GLEN & HALL MANUF. CO. South Water (*See page 675*)

Gordon J. F. rear 136 Mill
 HEWITT H. H. (*ploughs*), Platt near State (*See page 673*)
 ROCHESTER AGRICULTURAL WORKS, 100 South St. Paul (*See page 675*)
 WESTERVELT H. R., North Ford c. Canal (*See page 677*)

Air Gun Manufs.

BEISHEIM HENRY, 145 N. Water (*See page 674*)

Ales.

KLEIN & HOFHEINZ (*bottled*), 6 Exchange place (*See page 563*)
 MILLER F. J. 1 North av. (*See p. 563*)

Amusements.

Corinthian Hall, Exchange place
 Powers' Art Gallery, 170 Powers' bldgs.
 Rochester Opera House, 11 S. St. Paul

Aquariums.

STEIN SHOW CASE WORKS, Exchange corner Court (*See page 621*)

Architects.

Coots Charles, 102 Powers' buildings
 Forbes A. 12 Masonic block
 KNEBEL C. 64 Arcade (*See page 511*)
 LOOMIS ISAAC, 44 Smith's block (*See page 511*)
 Myers A. Fred. 38 Smith's block
 PUTNAM & GRAVES, 95 Powers' buildings (*See page 511*)
 Thomas J. R. 73 Arcade
 Warner & Cutler, 64 Powers' buildings

Architectural Work.

CHENEY W. H. (*iron*), 106 South St. Paul (*See page 652*)
 ROCHESTER FREAR STONE CO. Mt. Hope av. (*See page 650*)
 SHORER & TAILLIE (*iron*), 145 N. Water (*See page 682*)
 SIDDONS JOHN, 90 East Main (*See front colored page*)
 WHALEN D. 16 Stone (*See page 654*)
 YOUNG JAS. A. 51 South St. Paul (*See page 647*)

Art Gallery.

DEWEY D. M. (*engravings and paintings*) 8 Arcade (*See page 523*)
 POWERS', 170 Powers' bldgs. (*See page 500*)

Artesian Wells.

SHERRY G. E. 17 St. Joseph (*See p. 643*)

Artificial Flowers.

Tippets Eliza Mrs. 43 State

Artificial Limbs.

Bly D. Mrs. 111 Arcade
 DAWES JOSEPH, 170 West avenue (*See page 587*)
 Lockie Peter, 443 Brown

Artists.*See Painters; also Sculptors.***Artists' Materials.**BARNARD J. C. 23 Front (*See page 625*)HUNTINGTON M. & E. 36 E. Main
(*See front colored page*)**Auctioneers.**Brooks E. S. 110 West Main
CAULKINS W. R. & Co. 32 E. Main
(*See page 507*)Close & Yost, 2 East Main
Keogh James, 25 South St. Paul
Phillips G. 26 East Main**Auger Manufs.***See also Edge Tool Makers.*ZIEGLER L. & CO. foot North Water
near R. R. (*See page 673*)**Awnings.**FIELD JAMES, 42 Exchange (*See page 648*)**Axle Manufs.**ROCHESTER AXLE CO. 154 North
Water (*See page 608*)SCHIRCK A. & CO. 15 Warehouse
(*See page 682*)**Bag Manufs.**CRAMER J. G. 25 West Main (*See page 678*)**Baggage Barrows.**HOWE H. J. & CO. 3 Andrews (*See page 618*)**Baggage Express.**DECKER FRANK, West Main c. Ex-
change (*See page 572*)PRATT & WEED, 92 Mill (*See p. 604*).**Bakers.**Abbs John, 104 Plymouth avenue
Ambrom C. 102½ East avenue
Anthony Bros. 139 North Water
Augenstein Chas. 128 South avenue
Balke Christian, 95 North Clinton
Bastian G. 90 West avenue
Bickel John, 207 North Clinton
Busch Barbara, Grape cor. Campbell
Carnall Henry S. 28 Lake avenue
Corey H. A. 79 North avenue
Culross A. 130 South St. Paul
Culross James R. 307 State
Danzer Stephen, 21 Childs
DeCook J. 225 North
Deinger Frederick, 138 North avenue
Dollinger August C. 78 Chatham
Durnherr E. 81 Lyell
Eames E. N. 19 Monroe avenue
Eisenmenger Peter, 154 West Main
Elbs George, 117 Lyell
Ertle J. 50 Orange
Fichtner David, 158 North avenueFiesler J. P. 51 Grape
FLÜCKENSTEIN BROS. (*Steam*),
Brown cor. Maple (*See page 573*)
French Samuel, 185 East Main
Hefner Henry, 37 Scio
Hilfiker John, 43 Monroe avenue
Howe J. & Son, 45 Fitzhugh
Huette William, 11 King
Huhn Bros. 55 Henry
Husted W. N. Mrs. 212 W. Main
Kenning C. 34 Atwater
Kesel Frederick, 240 North Clinton
Kirchhof Nicholas, 69 Front
Klein Jerome, 128 South avenue
Kuehler A. 80 Hudson
Lampman L. O. 113 East Main
Nothaker John, 107 St. Joseph
Oppell George, 220 North Clinton
Osborn John D. 147 E. Main
Pfeiffer C. 25 Galusha
Preuss August T. 233 E. Main
Reif John, 96 North avenue
Rosenberger Joseph, 45 North Clinton
Schicker Bros. 131 Hudson
Schultz C. 134 North St. Paul
Schwingler John, 9 Delevan
Seith George F. 99 Hudson
Stoll Bros. 34 St. Joseph
Weitzel H. H. 46 South St. Paul
Wiesner J. 45 Andrews
Willingham Wm. 40 North Union
Witzell A. 262 State
Yawman P. 101 Caledonia avenue
Young Wm. B. 197 Monroe avenue**Baking Powders.**Hadley Nicholas, 22 South St. Paul
DE LAND H. A. & CO. Fairport,
N. Y. (*See page 584*)
Marden James & Co. 85 Front
NEWMAN S. A. at Fairport (*See page 585*)**Band Saws.**CONNELL & DENGLE, 123 Mill
(*See opp. page 551*)**Bands.***See also Music.*FIFTY-FOURTH REGT. BAND, J.
Sauer, leader, Aqueduct (*See p. 524*)**Bank Locks.**SARGENT & GREENLEAF, Court
cor. Stone (*See front colored page*)**Bankers.**AMSDEN F. J., Powers' bldgs. (*base-ment*), (*See page 505*)
Corning T. B. & W. 109 West Main
ERICKSON, JENNINGS & MUM-
FORD, 25 State (*See page 501*)
POWERS D. W., West Main c. State
(*See page 500*)
SAFE DEPOSIT CO. 31 State (*See page 499*)
STETTMEIER, TONE & CO. 8
State (*See page 501*)

Banks.*See Contents.***Barber Chairs.**

ARCHER GEO. W. 7 North Water
(*See page 621*)

Barbers.*See Hairdressers.***Barometers.**

TAYLOR BROS. 3 Hill (*See page 669*)

**Barrel Head and Stave
Manufacturers.**

LOVECRAFT JOSEPH & SON, 92
Allen (*See page 671*)

LOVECRAFT WILLIAM, 92 Allen
(*See page 671*)

PORTER SAMUEL, Oak cor. Smith
(*See page 671*)

Barrel Machinery.

GREENWOOD JOHN & CO. 124
Mill near Furnace (*See page 688*)

Basket Makers.

Schmidt Nicholas, 61 Weld
Shoemann John, 35 Weld

Bathing Houses.

BRUCE W. H. 5 Exchange (*See page
567*)

Doxtater C. B. & Bro. 67 N. Water

Hussey Chas. S. 59 State

Kingsbury Henry D. 185 Powers' bldgs.

Beer Manufs.

Caldwell T. E. 143½ South avenue

REISKY & SPIES, 111 N. St. Paul
(*See page 563*)

Bell Hangers.*See Locksmiths.***Belt and Hose.**

BURKE WILLIAM & CO. (*belting*),
12 West Main (*See page 631*)

Cross Bros. 108 Front

Bill Poster.

CALLAHAN JAS. 8 Corinthian Hall
bldg. (*See page 521*)

Billiard Rooms.

Griffin H. 17 South St. Paul

Ingalls & Schwikert, 4 Mill

Keyes C. E. 7 South St. Paul

Twitchell T. 41 East Main

Westfall & Co. 28 East Main

Billiard Table Manufs.

SCHWIKERT FRANK, 12 S. Water
(*See page 596*)

Bitters Manuf.

HOP BITTERS MFG. CO. 50 Mill
(*See page 596*)

Blacking Manufs.

Gillam H. E. & Co 149 State

VACUUM OIL CO. 128 Powers'
bldgs. (*See page 681*)

Blacksmiths.*See also Carriage Makers.*

Anderson John, 12 Division

Angele Louis, 101 North avenue

Bartholomay F., Scrantom n. North
Clinton

Bettner Thomas, 11 Mt. Hope avenue

Costello H. W., Carthage al. n. River

Cullen James, 31 Mumford

Culver Madison, 3 North avenue

Cutting & Cooney, 5 North avenue

Deitz John F., Mill cor. Platt

Dockstader & Redding, 8 Centre

Eagan William, 9 Ely

Emerson A. F., Mill near Brown

Ford Geo. M. 109 Mt. Hope avenue

Fox E. 8 Centre near State

Fry Edward, Lyell near R. R.

Garvey Patrick, 55 Fitzhugh

Grant Ranald, Alexander n. Broadway

Grimble E. 170 East Main

Hicks & Schmitt, 5 Spring

Hutter Arnold F., E. Main c. Goodman

King Charles H., Lyell near R. R.

Kirby Thomas, 115 S. St. Paul

Kohl Adam, 125 N. St. Paul

KOHLMETZ H. 121 N. Water (*See page
677*)

La Fontaine L. G., Chatham

Lobb William, 174 East Main

Lockett & Horner, 133 S. St. Paul

Marron John, 161 Lake avenue

Mausnest Leonard, 133 Hudson

McKenzie & Co. 1 Allen

MELVIN JAMES, 4 S. Washington

(See page 605)

Monaghan John jr. 2 Plymouth av.

Monahan & Eustice, 9 Division

Moran Patrick, 90 Front

O'Brien J. B. 2 Ely

Quinlan Dennis, 57 West avenue

Rapp Charles, Lyell near Sherman

Rippin Joseph, 117 N. Water

Ritt John, 245 East Main

Robinson J. A. 14 Market

Rosen Charles, 161 North avenue

Ruppert Philip, 150 Plymouth avenue

Saalwachter Jacob, 508 Brown

Scherer & Benner, near 137 Lake av.

Schneckel Christopher, 170 St. Joseph

Siebert Frank, 226 North Clinton

Smith John, 4 Smith

Smith N. H. 107 S. St. Paul

Steinhauer Jacob, 51 North avenue

Stokes Jabez, North av. c. Franklin

Streiff Bros. 8 Plymouth avenue

Striker & Harrison, 183 West av.

Sullivan James, Brown near State

A. R. PRITCHARD & LIKLY,**SOLID RED CEDAR TRUNKS,
No. 78 STATE STREET.**

Sullivan John, 109 Pinnacle avenue
Symonds A. J., North av. c. Franklin
Thorn G. rear 83 Front
Verhoeven August, 225 N. St. Paul
Wager Miles, 249 East Main
Young F., Favor near West avenue

Blank Book Manufs.

BENFORD & ANDREWS, 1 Aqueduct (See opposite page 513)
CREED & AVERY, 29 West Main (See page 520)
MOORE JOHN C. 27 Smiths block, (See page 519)
STRATTON G. L. & CO. 61 State (See page 529)

Bluing Manufs.

Fay A. H. & Co. 14 North Water
Van Hees H. 237 North Clinton

Boarding Houses.

Armstrong M. A. 9 South Ford
Arnold Mary Mrs. 8 Wilder
Baily Lucy Mrs. 2 Oak
Benton Sarah Mrs. 3 South
Black M. W. 13½ East avenue
Briggs L. M. 39 N. St. Paul
Brown Aurelia, 21 William
Brown H. S. 11 Chestnut park
Brown M. A. Mrs. 68 S. St. Paul
Buff Louis, 36½ South St. Paul
Button Elsesta, 306 State
Callan Sarah Mrs. 18 Allen
CHAPMAN HOUSE, Geo. H. Clute, 44 South St. Paul (See page 567)
Clark Jeremiah, 102½ East Main
Clark Julia, 117½ East Main
Conlan E. Miss, 54 Allen
Cook Henrietta, 37 North St. Paul
Cooper Sarah, 24 Centre
Cronk Wm. 12 N. Washington
Currier Richard, 224½ East Main
Curtis A. Mrs. 84 East avenue
Cushman O. Mrs. 31 Court
Cutler H. Miss, 27 N. Clinton
Dewey Caroline Mrs. 11 Centre park
Dudeney Eliza Mrs. 35 Frank
Elliott I. Mrs. 2 Frank
Foley Alice, 34 Oak
Gardner Agnes A. Mrs. 107½ E. Main
Goodman Harriet E. 8 North Ford
Grivet Jerome, 150 S. St. Paul
Hart C. T. Mrs. 169 East Main
Henion Ann, 11 Elizabeth
Hicks T. 25 Allen
Holloway M. F. Mrs. 34 North Washington
Hunter E. A. 119½ East Main
Hunter Julia H. 8 Kent
Hyatt E. Mrs. 205 State
Ivan Julia, 37 N. St. Paul
Jones A. M. Mrs. 58 Frank
Kane A. Miss, 38 Platt
Kavanagh Mary Mrs. 33 Frank
Kearns Anna, 43 Atwater
Kelley Anna, 6 Ely
Kelly Michael, 62 Exchange

Kenealy S. Mrs. 38 Allen
Kingsley Kate, 36 N. Washington
Kirkpatrick Sarah, 50 Allen
Kurtz John M. 94 North Clinton
Lawrence F. S. 5 Howell
Litster Emma, 171½ East Main
Livingston Eliza, 16 North Clinton
Major J. P. 97½ East Main
McCoart Jeremiah, 14 Platt
McDonald Cynthia Mrs. 340 State
McGarry Patrick, 35 N. St. Paul
McGlachlin H. F. Mrs. 53 Atkinson
McGovern A. Mrs. 167 State
McKinney B. Mrs. 218 West Main
McMullen Bridget Mrs. 31 S. St. Paul
Mordoff Jane Mrs. 180 State
Mosher J. Mrs. 121½ East Main
Murray Thomas, 113½ East Main
Myles & Fordyce, 146½ West Main
Naracon V. 5 North Washington
Nicholas Eliza A. 203 State
O'Brien Hanora Mrs. 5 Ely
Phelps Anna Mrs. 228 N. Clinton
Porter M. G. 12 Canal
Pruyn Melvina, 26 Jones
Putnam M. S. Mrs. 59 Fitzhugh
Ragan Catharine, 37 Frank
Richardson E. Mrs. 21 Elm
Rogers Mary, Mortimer c. N. Water
Ross G. Mrs. 170½ West Main
Schleber Dorathea Mrs. 91 Front
Sharp M. Mrs. 3 Achilles
Sherwood Ellen Mrs. 22 Frank
Spears William, 23 Jay
Spindler H. 67 Nassau
Steenburg Lena, 4 N. Washington
Stocking M. L. Mrs. 38 S. St. Paul
Stone C. J. 134 S. St. Paul
Stone S. J. Mrs. 6 Platt
Townsend Helene, 172 East Main
Tuton Sarah C. 27 N. St. Paul
Van Bentheysen Mary A. 16 Allen
Westfall T. H. 21 S. St. Paul
Whitney Jane, 32 Stone
Williams Mary, 143 East Main
Witzigman C. 173 North
Zimbrich Daniel, 116 North Water

Boat Builders.

DOYLE JOSEPH (*yachts*), Charlotte (See page 598)
Hingston Samuel, Exchange st. slip
Meyer C. C., Meigs street bridge
Meyer Philip J. 41 Broadway
SMITH CHAS. L. (*shells*), rear S. St. Paul, opp. Griffith (See page 576)

Boats to Let.

BENNETT S. & SON, foot lower falls (See page 647)

Boiler Makers.

KELLY PETER, 130 Mill near Platt (See page 672)
SINTZENICH E. B. 12 South Water (See page 674)
WOODBURY, BOOTH & PRYOR, 188 Mill near Platt (See page 687)

HENRY C. WISNER,

SUPERIOR ENGLISH CARVERS and BEEF SLICERS--No. 33 STATE STREET.

Bolt Manufs.

HEUGHES J. C. & CO., Mill corner
Platt (See page 662)
PALMER T. G. 87 Front (See page 662)

Book Binders.

BENFORD & ANDREWS, 1 Aque-
duct (See opp. page 513)
CREED & AVERY, 29 West Main
(See page 520)
Hawley N. G. 55 State
MOORE J. C. 27 Smith's block (See
page 519)
SAX S. 51 Front (See page 519)

Bookstores.

See also Stationers ; also News Depots.

AMERICAN TRACT SOCIETY, 75
State (See page 519)
Cunningham M. 96 State
DARROW E. 1 Osburn House block,
67 East Main (See page 518)
DREW, ALLIS & CO. (directories), 114
Powers' buildings (See front colored
page)
Ernst Lorenz, 28 Franklin
GROSVENOR O. D. 75 State (See
page 519)
May E. B. 45 East Main
McGowan J. J., W. Main c. Fitzhugh
MERRIAM & CO. 40 W. Main (See
page 518)
MERK W. (German), 5 North Clinton
(See page 514)
Penny A. G. 272 State
Ruppanner James, 251 State
Scrantom & Wetmore, 12 State
STEELE & AVERY, 44 State (See
page 519)
Tower & Herrick, 6 Exchange
Weld & Jackson, 4 Arcade
Wilcox W. J. 150 State
WILLIAMSON & HIGBIE, 62 West
Main (See page 518)

Boot and Shoe Boxes.

STEVENS J. B. & SON, foot Centre
(See page 535)

Boot and Shoe Insoles.

ROCHESTER INSOLE MFG. CO.
75 N. Water (See page 667)

**Boot and Shoe Tool Manu-
facturers.**

GRAVES L. S., Mill corner Factory
(See page 690)
HEUGHES J. C. & CO., Mill c. Platt
(See page 662)
TOWNSEND & WISEMAN, 1 An-
drews c. N. Water (See page 665)

**Boot Last and Tree
Manufs.**

DUFNER JOHN, Mill n. Factory (See
page 663)

Boots and Shoes.

MAKERS AND REPAIRERS.

Albert George, 47 Cady
Andrews Julius, 642 West avenue
Andrews R. 147 Frank
Attridge Samuel, 2 North Union
Bastian H. 142 Jay
Belkirch John, 157 Pinnacle avenue
Bennett F. 19 West avenue
Beyerlein Henry, 18 Olean
Blust Henry, 233 N. Clinton
Bock Conrad, 43 North avenue
Breu George, 140 Brown
Briemer Nicholas, 49 Kelly
Burket James, 39 Brown
Clarke John, 223 W. Main
Connell James, 73 Lyell
Coyle P. 111½ State
Crandall W. E. 108 Plymouth avenue
Dietrick George, 350 Brown
Dobson Isaac, 160 East Main
EASTWOOD WM. 22 State (See under
Population of Towns and Cities).
Engler Henry, 9 North Clinton
Fischer John, 109½ Jay
Fitzgerald Richard, 35 Smith
Fraas John A. 12 Market
Gamel Nicholas, 249 N. Clinton
Glasser & Bro. 121 Jay
Goodger H., Jay cor. State
Gosnell Wm. Monroe av. c. Marshall
Greve Henry, 68 Herman
Griffen James, 9 Spring
Gross Louis, 254 N. Clinton
Guild Josiah, 133 West Main
Guse A. C. 54 Chatham
Guth Joseph, 251 N. Clinton
Haas John, 22 Front
Haberbasch F. 207 North
Hart John, 212 East Main
Hatterscheit P. 136 Hudson
Hess Frederick, 67 North avenue
Hohman Victor, 4 West avenue
Hunt R. 31 West avenue
Jacobs John H. 108 St. Joseph
Kalb Frank, S. St. Paul c. Griffith
Kehl Caspar, Lake av. n. Ridge road
Kehn Edward J. 75 West avenue
Kegel Nicholas, 127 Scio
Kinzel William, 25 Hickory
Knapp P. 291 N. Clinton
Koehler Moses, 48 Monroe avenue
Kolkman John, 129 St. Joseph
Kraft Louis, 100 Front
Kropp George, 62 Wilder
Lawrence John, 26 Charlotte
Levielle Charles, 127 S. St. Paul
Loasby Samuel, 160½ North avenue
Mandery Leonhard, 84 S. St. Paul
Manseau A. E. 1 Mill
Maynard Jesse S. 97 Lake avenue
McCoy John H. 5 Stone
Miller George, 37 Hand
Morrison John T. 30 East Main
Oetzel John, 15 South avenue
Palland Frank, 227 E. Main
Parry John, 116 Plymouth avenue

Popp John G. 81 Mt. Hope avenue
 Popp Leonard, 27 Mt. Hope avenue
 PRATT L. A. 54 State (See page 540)
 Eausch John, 174 West avenue
 Reid William, 164 E. Main
 Rohde C. 66 Nassau
 Roos Louis, 37 Baden
 Russell Joseph L. 87 Pinnacle av.
 Schairer Anton, 133 Lake avenue
 Schamine Peter, 97 South avenue
 Scheidrich T. 50 Front
 Schloegel Matthias, 158 Plymouth av.
 Schmidt Frederick, 5 Maria
 SCHMITT ADAM, State cor. Centre
 (See page 542)

Schrank L. 14 Weld
 Schuhman M. 43 Herman
 Sehm John, Goodman n. Bay
 SPAULDING & MARTIN, 114 Ply-
 mouth av. (See page 577)

Stoltz Michael, 16 Bartlett
 Stoppelbein Jacob, 190 State
 Thon Gottlieb, 27 Whitney
 Tucker Peter, 12 South avenue
 Tuschong Michael, Centre n. State
 WEBSTER E. D. 117 East Main (See
 page 540)

Weighell I. 7 Spring
 Widman John, 26 Herman
 Wiegand Caspar, 118 East avenue
 Williamson W. 76 Caledonia av.
 Witzigman Caspar, Webster n. North
 Yeackle J. 111 Lyell
 Young Joseph, 4 Tonawanda
 Zoerner Charles, 48 West avenue
 Zonneville John M. 45 St. Joseph

Boots and Shoes.

MANUFACTURERS.

Bradford J. W. (uppers), 6 N. Water
 Brooks & Reynolds, 139 State
 Byrnes J. H. & P. 91 North Water
 Chapman & Stewart, 10½ Mill
 Cleveland C. A. 7 South St. Paul
 Cowles, Curtis & Co. 15 Mill
 Cowles & Harris, 8 N. Water
 Cox & Brady, 83 North Water
 Ellison & Stoddard, 77 North Water
 END F. (slippers), 7 Andrews (See page
 667)

EVANS JAMES J., River n. N. Water
 (See page 666)

Gant James, River n. N. St. Paul
 Hatch J. W. & Son, 124 Front
 Jaquith E. A. 44 Exchange
 JOHNSON A. J. & CO. 4 Allen (See
 page 664)

Keller & Goodhue, 87 N. Water
 Kelly J., N. Water c. Andrews
 Meyer George P. & Co., River n. N. St.
 Paul

PANCOST, SAGE & MORSE, 92
 State and 55 Mill (See page 663)

PHELAN & BOLTON, Andrews c.
 N. Water (See page 664)

REED & WEAVER, 111 State (See
 page 666)

ROCHESTER BOOT MFG. CO. 81
 North Water (See page 664)
 Smith J. P., River near North Water
 STEWART J. T. & SON, 1 Andrews
 (See page 666)
 Stockbridge, Brayton & Co. 75 North
 Water
 WESTBURY D. H. 79 N. Water (See
 page 542)
 Wiegand E. 7 South St. Paul
 Williams & Hoyt, 79 North Water
 Wood M. E. 77 North Water
 WRIGHT D. W. & CO. 73 N. Water
 (See page 578)

Boots and Shoes.

RETAIL DEALERS.

BECK L. P. & BRO. 87 East Main
 (See page 540)

Bieck Anthony, 199½ N. Clinton
 Boss A. & Co. 76 North av.

Bott J. A. 246 State

Ditner Alois, 270 State

EASTWOOD WILLIAM, 22 State
 (See under Population of Towns and
 Cities)

Frost S. K. 9 State

Gould George & Son, 16 State

Groh J. 18 South St. Paul

Grover L. B. 114 West Main

Hulbert J. E. 37 East Main

Hutte Charles, 85 North Clinton

Kelly William, 340 State

Klier J. Baptist, 231 Brown

Koehler F., 235 East Main

Koza George, 343 State

LEAT & WEITZEL, 127 East Main
 (See page 593)

Leckinger G. M. 10 South St. Paul

Leckinger M. 123 East Main

Leonard J. M. 322 State

Lines S. V. & Sons, 50 State

Meng John, 103 North av.

Minges S. 3 Franklin

Moore R. J. 140 West Main

Oswald Oluf, 101 Hudson

Phelan J. H. 2 Mumford

PRATT L. A. 54 State (See page 540)

Raab John, 194 North Clinton

Repp Charles, 151 North avenue

Roades William, 38 West Main

Rochester Home Industry, 124 W. Main

Sanderl J. B. 105 North Clinton

Schamine Peter, 97 South avenue

SCHMITT ADAM, 162 State (See page
 542)

Schoepfel Charles, 242 North Clinton

Searing S. H. 91 East avenue

Seuffert F. M. 78 Kelly

Skillman Peter E. 104 Hudson

Smith Austin S. 8 East Main

Steward J. W. 63 Jay

Van Dake H. F. 34 West Main

Watervisser John D. V. 2 Hudson

WEBSTER E. D. 117 East Main (See
 page 540)

Weigand Joseph, 5 Magne

HENRY C. WISNER,

**KEROSENE CHANDELIERS, BRACKETS,
 and LAMPS--No. 33 STATE STREET.**

Weingartner J. J. 85 Chatham
 White T. P. 118 West Main
 Wiegand Caspar, 118 East avenue
 Woolard J. 51 East Main

Boots and Shoes.

WHOLESALE DEALERS.

DAVIS, MOULTON & CO. 36 Exchange (See page 666)
 EVANS JAMES J., River near N. Water (See page 666)
 GOODWIN & BISHOP, 109 State (See page 664)
 JOHNSON A. J. & CO. 4 Allen (See page 664)
 PANCAST, SAGE & MORSE, 92 State (See page 663)
 PHELAN & BOLTON, North Water cor Andrews (See page 664)
 REED & WEAVER, 111 State (See page 666)
 ROCHESTER BOOT M'FG. CO. 81 North Water (See page 664)
 ROSS L. P. 147 State (See page 592)
 WESTBURY D. H. 79 North Water (See page 542)
 WRIGHT D. W. & CO. 73 North Water (See page 578)

Bottle Makers.

Mathis & Neuhart, 229 East Main

Bottle Moulds.

SCHAFFER J. C. 6 Hill (See page 684)

Bottlers.

Goulding & Co. 30 Lake avenue
 KLEIN & HOFHEINZ (ales), 6 Exchange place (See page 563)
 MILLER F. J. 1 North avenue (See page 563)
 SCHNARR H. H. & BRO. 114 North Clinton (See page 566)
 Quambush & Henry, 127 East Main

Box Makers.

BLAKENEY & CO. (cigar), 3 Aqueduct (See page 564)
 DISBROW I. S. (wood), 3 Aqueduct (See page 630)
 HUNT J. K. 91 North Water (See page 645)
 Kronsbein F. 149 North Water
 LETTINGTON H. 25 Exchange place (See page 645)
 Mallory Orlando, agent, 57 State
 Rutt Ann (bandbox), 17½ Montrose
 SAUER JACOB (cigar), Aqueduct near canal (See page 564)
 STEVENS J. B. & SON, foot Centre (See page 535)

Brackets (Black Walnut).

BANTLEON D. (house), rear 123 N. Water (See page 649)
 Hicks Elon D., Jay corner canal

JONES A. J. 22 East Main (See page 648)

WOODWARD C. W. 126 State (See page 532)

Brass Founders.

WRAY HENRY & SON, 109 Mill (See page 672)

Brewers.

See also *Maltsters.*

Baetzel J. G. & Bro., North Clinton
 Bartholomay Brew. Co. 139 N. St. Paul
 Boehm John, Colvin c. W. Maple
 Enright Patrick & Son, Mill c. Factory
 Hathaway & Gordon, 65 North Water
 Kirst Matthias, 106 St. Joseph
 Marburger Jacob, 106 N. Clinton
 Mayer & Suiler, Cottage
 Meyer & Loeb, 110 Hudson
 Miller F. 106 Lake avenue
 Miller William, 58 North avenue
 Nunn Joseph A. jr. Brown c. Wentworth
 REISKY & SPIES, 111 N. St. Paul, (See page 563)
 ROCHESTER BREWING CO. foot Cliff (See page 562)
 Warren E. K., Atwater c. N. St. Paul
 Weinmann Margaret, 165 Jay
 Yaman Joseph, Jay c. Saxton
 Zimmerman George, Colvin c. Syke

Brick Manufs.

HAHN, WEIS & CO. 52 S. St. Paul, (See p. 638)
 ROCH. ADAMANTINE BRICK CO. 5 Masonic block (See page 638)
 ROCHESTER BRICK AND TILE CO. Ira L. Otis supt. 51 Powers' buildings (See page 638)

Bridge Builders.

LEIGHTON THOMAS, Leighton av. (See back colored page)

Brokers.

See also *Agents.*

Griffin E. 53 Powers' buildings
 Loveridge G. 53 Powers' buildings
 Nusbaum A. (paw), 19 S. St. Paul
 Ryan G. R. (paw), 16 West Main
 Travers C. L. (paw), 10½ S. St. Paul

Broom Makers.

Croston Frank, S. St. Paul cor. Court
 Grant Geo. J., Reynolds c. Champlain
 James Wm. T. 5 North Ford

Brush Manufs.

COONEY WM. Aqueduct near canal (See page 669)

Miles Samuel A. 145 University avenue

Builders.

See *carpenters; also masons; also contractors.*

Building Movers.

Bosley Alonzo, 77 North avenue
 HEATH JOHN G. 186 N. St. Paul
 (See page 642)
 VROMAN & YOUNG, 105 North
 (See page 651)

Bung Manuf.

SCHULER CHAS. F. 131 N. Water
 (See page 592)

Burial Caskets.

MAXWELL, NEWMAN, McMAN-
 NIS & CO. 22 S. St. Paul (See
 page 578)
 STEIN PATENT BURIAL CAS-
 KET WORKS, Court corner Ex-
 change (See page 621)

Butchers.

See markets.

Cabinet Makers.

BARTH & ZEISLEIN, 69 N. St.
 Paul (See page 620)
 BURLEY & DEWEY, 88 State (See
 page 629)
 Draude A. 123 Mill
 DUNHAM & CO. 117 N. Water (See
 page 613)
 Eckerle J., Aqueduct n. canal
 Fenn H. C. 107 State
 Geyer Albin, Aqueduct n. canal
 HAYDEN C. J. & CO. 184 and 186
 State (See page 613)
 Hayden J. E. & Co. 73 State
 HUNN, SPENCER & CO. 74 State
 (See page 612)
 Lewis & Parker, 153 W. Main
 MICHELSEN & RUCKDESCHEL,
 Mill foot Brown (See page 624)
 Minges Bros. 6 Front
 Perrin A. 198 N. Clinton
 Perrin Brothers, Rowe n. Lake avenue
 Ritter Frank, 117 North Water
 Robinson C. 15 Warehouse
 Robinson O. & C. B. 123 State
 SCHANTZ, MINGES, SHALE & CO.
 15 North Water (See page 622)
 Schutte Joseph, 133 North Water
 VETTER AUGUST & CO. 149 North
 Water (See page 620)

Cables (Power.)

COWLES JOSEPH, 125 Mill (See page
 676)

Can Openers.

Sprague Can Opener Co. 89 N. Water

Candle Manufs.

Anderson Jacob, 101 Exchange

Canes.

PRITCHARD A. R. & LIKLY, 78
 State (See foot lines through book)

Carpenters.

Albrecht & Niedermeier, Clifford near
 Edward
 ALDRIDGE GEORGE W. 51 Powers'
 buildings (See page 632)
 Alling D. C. 28 Andrews
 ARCHER J. W. 114 North Water (See
 page 643)
 Arnold James, 46 Meigs
 Bell John, 40 Jay
 Bell Thomas, 93 Exchange
 Blackman Thomas, 5 Penn
 Blakeney Isaac W., Jefferson park
 Blum Louis, 21 Pryor
 Boyd R. G., Jones av. c. Saratoga av.
 Brown John S. 23 Park avenue
 Campbell & Van Anden, 4 Huntington
 Cannan Thomas, 15 Sheridan park
 Carter E. W. 34 North avenue
 CASE C. W. 35 Goodman (See page 641)
 Cowman & Flynn, 19 Emerson
 Crouch James, 144 Jones
 Crane E. W. 131 Fulton avenue
 Crane Thomas, 16 Weld
 Dannals R. M. 177 Plymouth avenue
 Davis John W. 4 Litchfield
 Defendorf Jesse, foot Ambrose
 Delano E. W. west end Court st. bridge
 Delano M. L. west end Court st. bridge
 Deyo J. M. 3 Maple place
 Dorschell R. 126 Hudson
 Elliott A. foot White
 Finding Joseph, 7 Smith
 Flora Frank A. 60 Cady
 Flowerday Joshua R. North York
 Fouquet Philip, 313 N. Clinton
 Fox Jacob, 27 Kelly
 Freatman A. 3 Saratoga avenue
 Gessner J. 8 Rauber
 Gosnell John, rear 4 Kirk
 GRAHAM L. R. S. 23 Ontario (See
 page 590)
 Gundlach Michael, 21 Minerva alley
 HALL GEORGE, Joiner c. Kelly (See
 page 640)
 Harris D. 3 Sycamore
 Hein Jacob, 141 Hudson
 Hellems Isaac, 18 Oak
 Hitchcock Joseph, 65 Adams
 Hoopam A. W. 24 Kelly
 Jefferis John H. 37 King
 Jeffords Chas. A., Alexander c. Broad-
 way
 Jennings W. H. 42 Chatham
 Jesserer L., Frances corner Hunter
 Keener John, 27 Plymouth avenue
 Kimble H. B. 81 Weld
 Klinkhammer Henry, Colvin n. West
 Maple
 Koehler John, 84 South avenue
 Kramer N., Walnut near Campbell
 KRAFT & SIEBERT, 5 Ringlestein al.
 (See page 588)
 Langie Anthony, rear 23 Charlotte
 Laufer Christian, Lincoln n. city line
 Lill Joseph, 43 Rauber
 Lincoln D. W. 29 Gregory

HENRY C. WISNER,

**CRYSTAL BUD VASES, EPERGNES, ETC.,
 No. 33 STATE STREET.**

LUCREE MORRIS, Ames c. Campbell
(See page 590)
LUTHER JOHN, rear 54 North av.
(See page 636)
MARSON WILLIAM H. 5 Spring
(See page 634)
Matthews Wm. 106 Jay
MAUDER F. J., Oakman c. Galusha
(See page 633)
McCoy & Fabling, 3 North avenue
McFarland John, 68 Bolivar
McNary John, 7 Whalen
MILES FRANK, Minerva alley (See
page 632)
MILLER & VAN SCHUYVER, 147
West Main (See page 590)
Mitchell Thomas, rear 220 State
Montgomery John F. 37 Pinnacle av.
MURA DOMINICK, 23 Gorham (See
page 640)
OBERLIES H., Bond cor. Grand (See
page 637)
Padley J. 195 Exchange
PARKER H. D. 63 Broadway (See
page 635)
Patterson R. 4 North Frances
Pidrick William, Smith cor. Walnut
PIKE J. B., Minerva pl. (See page 591)
Punnett Reuben, 18 Magne
Ratt William, 3 Aqueduct
Rhines Peter F. 39 Cherry
Rice Henry, 122 South avenue
RICHARDS WM., Myrtle near Lyell
(See page 635)
Robb William R. 8 N. Washington
Robinson Bros. 33 King
Robinson John D. 3 New York
SALTER T. 148 Plymouth avenue
(See page 635)
Sauer H. G., 7½ Gregory
SAUNDERS WM. Scott alley (See
page 634)
Scouten C. 43 South Washington
Sedgwick S. D. 15 Jay
Showers W. H. 413 Brown
SIEBERT CASPAR, 105 Pinnacle av.
(See page 641)
Silence Edward, 146 S. St. Paul
Simmelink J. H., Hudson n. Berlin
Simmons J. 70 Bartlett
Smith Elias, 21 Emerson
Stade F. & Co. 172 North
STEPHANY J. 54 Nassau (See p. 632)
Stewart James, Franklin c. North av.
St. Helen John, 23 North Washington
St. Helen Roger, 18 Campbell
Stroyer & Christiaansen, 63 Asylum
Suter Jacob, 107 S. St. Paul
TANNER WM. r. 196 West Main (See
page 634)
Taylor P. W. west end Court st. bridge
Thomas J. W., Clifford near Thomas
Thomson G. 40 Tremont
Turk Herbert, 2 West Troup
Turner R. E., Chili road n. West av.
TURVER CHARLES II. 39 S. Ford
(See page 582)
Underhill R. W. 19 Bolivar

Vanderwerf L. r. 138 University av.
VanHoute John, Brown's alley
WAGNER J. G. 14 St. Joseph (See
page 632)
WAGNER P. & W. (agents), 59 Asy-
lum (See page 636)
Wagstaff James, rear 73 East avenue
WARE J. B. 40 Fulton avenue (See
page 635)
Warner G. L. 34 West Troup
Webb William, 53 Reynolds
Wendell M. T. 19 William
Whitley Thomas, 212 North
Wiborn J. 18 Hamilton place
WILLIAMSON R. & W. rear 8 Allen
(See page 588)
Williamson Thos. Litchfield n. canal
Wolf William, 193 North Clinton
Wood James, 71 Scio
Wright Richard, rear 29 Upton park
Wright William, 80 Troup
Yates C. F. 119 Adams
Zwergger & Mattern, Clifford n. North
Clinton

Carpet Cleaner.

LEINEN P. 162 South St. Paul (See
page 597)

Carpet Weavers.

Brayshaw James, rear 307 State
Fischer Barbara, 101 Campbell
Geyer Charles, 7 Weld
Gumprecht Adam, 56 Orange
Jones Humphrey, 298 Monroe avenue
Kern Frederica, 42 Howell
Marriott Joseph, 9 Lyell
Mason Amanda, 43 Platt
Meyer Christian, -8 Nassau
Sargisson John W. 42 Frost avenue
Seiler J., North avenue near Bay
Sixt Frank X. 11 Hope
Strohm Wm. 9 Elizabeth place
Thompson Robert, 84 Lyell

Carpets.

Carter I. F. 78 State
Beir L. 46 East Main
HOWE & ROGERS, 37 State (See
page 628)
O'DONOUGHUE J. & CO. 42 East
Main (See page 628)
ROGERS & CONVERSE, 14 Ex-
change (See page 597)

Carriage Axles.

ROCHESTER AXLE CO. 154 North
Water (See page 608)
SCHIRCK A. & CO. 15 Warehouse
(See page 682)

Carriage Hardware.

ROBY S. B. & CO. 80 State (See
page 607)

Carriage Makers.

See also Wagon Makers.

- Angele Anthony, 101 North avenue
 BAGLEY JACKSON, 17 North av.
 (See page 603)
 Clark W. D. rear 145 East Main
 CUNNINGHAM JAMES & SON, 3
 Canal (See page 610)
 DWYER MICHAEL, 26 Vienna (See
 page 603)
 GOODWIN & MASON, Fitzhugh
 near West Main (See page 602)
 HAHLE WM. H. 109 Pinnacle avenue
 (See page 604)
 Harrington & Richardson (children's),
 foot Centre
 Lowe Richard, (bodies), 4 Hill
 McDONOUGH J. H., Mortimer cor.
 North Water (See page 606)
 Stewart S. M. 31 Mumford
 TOBIN EDWARD, 4 Ely n. S. St.
 Paul (See page 605)

Carriage Repositories.

- CUNNINGHAM JAMES & SON, 3
 Canal (See page 610)
 GOODWIN & MASON, Fitzhugh
 near West Main (See page 602)
 McDONOUGH J. H., Mortimer cor.
 North Water (See page 606)

Carriage Trimmers.

- HYSNER DANIEL, Chatham corner
 Franklin (See page 603)
 Rockfellow E. L. 1 Lancaster

Carriage Wood Work.

- CORRIS WM. & CO., Hill cor. Eliza-
 beth (See page 607)

Carvers.

- IRVING A. G. 1 N. Water (See p. 629)
 Jackson J. H. B. 149 State
 Roda Adolph, River near N. St. Paul

Casket Manuf.

- STEIN S., Court cor. Exchange (See
 page 621)

Caterer.

- TEALL ISAAC, 38 Fitzhugh (See
 page 560)

Cement.

- COPELAND D. Jr. 90 South St. Paul
 (See page 658)
 GARBUT J. W. 85 Exchange (See page
 581)
 McCONNELL & JONES, Exchange
 cor. Spring (See page 657)

Cement Roofs and Walks.

- HOGLE FRANK M. 39 Tyler (See
 page 642)

Cemetery Work.

- HADDLETON JOSEPH (wire), 89
 State (See page 609)
 PITKIN PETER, 22 West av. (See
 page 660)

Chair Bottomers.

- Bohrer Xavier, 5 Weld

Chair Manufacturer.

- DUNHAM & CO. 117 North Water
 (See page 613)

Chemists.

- SPIEHLER A. 24 E. Main (See page 668)
 WOODWORTH C. B. & SON, 113 W.
 Main (See page 668)

Children's Carriages.

- HUGHES M. L. 110 State (See page 507)

China and Glass.

See also Crockeryware.

- RANDALL H. S. 51 State (See back
 cover)
 SCANLIN D. 68 West Main (See page
 628)
 SHAFFER H. E. 39 State (See back
 cover)
 WISNER HENRY C. 33 State (See
 foot lines through book)

Chiropodists.

- Buell G. E. 75 Arcade
 Clemons S. P., Goodman cor. Harvard

Chromos.

- MENSING, RAHN & STECHER,
 (publishers), 7 Market (See opp. page
 544)
 WOODWARD C. W. 126 State (See
 page 532)

Chromo Mounter.

- SAX S. 51 Front (See page 519)

Cider Manufs.

See also Vinegar.

- DUFFY W. B. & CO. 8 White (See
 page 594)
 O'NEIL & DEMPSEY, 342 State (See
 page 562)

Cigar Boxes and Labels.

- BLAKENEY & CO. 3 Aqueduct (See
 page 564)
 SAUER JACOB, foot Aqueduct (See
 page 564)

Cigar Manufs.

See also Tobacconists.

- Adelman F. A. 306 Brown
 Alt Jacob, 6 East Main
 Baker E. A. 117 State
 Bieber Charles, 53 North Clinton
 Boehm Christian, 149 St. Joseph
 Cocklin John, Magnolia near Genesee
 Coffee L. 87 Front
 COURTNEY & HENRY, 341 State
 (See page 565)
 DAMON M. J. 3 Eagle (See page 565)
 Donovan C. 9 Caledonia avenue

Erden Frank, 9 Shamrock
 Fackler John, 132 Lake avenue
 Finzer John C. 70 St. Joseph
 Frank Peter, Leavenworth alley near
 Champion
 Fritz Anton, 99 Wilder
 Furtherer Matthias, 24 Gorham
GARIN & MEAGHER, 147 East Main
 (See page 564)
 Geis Abraham, 39 Lowell
GUCKER C. & G., Mill corner Factory
 (See page 565)
 Hene H. 40 Andrews
HESS S. F. 7 Exchange (See page 566)
 Howe Wm. 7 Childs
 Hubbard Wm. H., Scio cor. Charlotte
 James F. T. 6 North Water
 Krank Geo. A. 41 Oakman
 Krapp F. T. 49 Hanover
 Kuder Christian 117 Saxton
 Kueblar J. G. 216 West Main
 Leibert F., North York cor. W. Maple
 Levison B. 52 North Clinton
 Link C. A. 8 Caspar
 Martens H. A. 56 Martin
 McCarthy John, 45 East Main
 McCarthy J. J. 138 West Main
 McDermott T. 22 S. St. Paul
 Michaels Adolph, 33 Monroe av.
 Nelligan S. T. 139 St. Joseph
 Rigney John J. 55 State
 Rose Anna Mrs. 218 West Main
 Schulz & Hickey, rear 46 South av.
 Shelter George, 104 St. Joseph
 Siebe George F. 18 Atwater
 Stahlbrodt C. A. 91 Chatham
STAPE JOHN (*wholesale*), 104 East
 avenue (See page 556)
 Staud Charles, 106 Allen
 Stoll Julius, 123½ East Main
 Sullivan Chas. 53 Arcade
 Van Dyke J. I. 48 Exchange
 Waldert W. & A. 77 South av.
 Walker Wm. H. 218 East Main
 Warncke P. 128½ West Main
 Weaver G. 147 North av.
 Weingartner G. E. 59½ Chatham
 Whalen R. & T. 182 State
 Wiegand F. & A. 93 North Clinton
 Williams Samuel, 97 Frank
 Wozack Adolph, 88 South St. Paul

Cistern Builders.

See also Carpenters.

ARCHER J. W. 114 North Water (See
 page 643)
 Black Joseph, 16 King
GLEICHAUF J. B. 37 Sanford (See
 page 643)
 Stork Michael, 307 Brown

Civil Engineers.

Babbitt Charles R. 147 Powers' bldgs.
 Beardsley Cyrus, 147 Powers' bldgs.
 Fitch H. L. 82 Powers' bldgs.
 Haven W. A. 92 Fulton avenue

Jones H. 57 State
 Nichols L. L. 35 Smith's block
 Peacock O. H., City Hall

Clairvoyant.

Eaton Gilbert C. 18 Platt
 Ketter M. Mrs. 21 Nassau

Clergymen.

See Contents.

Cloak Makers.

COFFIN W. H. MRS. 22 E. Main (See
 page 546)

Cloth Spongers.

McPherson Duncan, 10 West Main

Clothes Bars.

Denton James, 202 State

Clothing.

See also Tailors.

WHOLESALE DEALERS.

Britenstool H. & Son, 106 State
 Cauffman & Strouss, 46 Mill
 Conrad N. (*boys*), 5 Front
 Funkenstein & Moore, 10 Mill
 Garson L. & Co. 44 Mill
 Hays F. & S. 76 Mill
 Hays M. & Co. 68 Mill
 Kolb, Rosenberg & Co., Mill c. Mumford
 Levi N. & Co. 25 Mill
 McDonell James & Co. 24 State
 Michaels H. & Co. 70 Mill
 Rosenthal, Cauffman & Co. 72 Mill
 Schwarz Bros. 63 Mill
 Sloman I. M. & Son, 36 Mill
 Stein, Adler & Co. (*boys*), 14 Mumford
 Wile G. & J. & Co. 64 Mill
 Wile Bros. & Co. 74 Mill

RETAIL DEALERS.

Allen, Straus & Co. 24 West Main
 Aronson R. 3 East Main
 Banta Olivia M. (*boys*), 1 Smith
BORNEMAN BROS. 8 North Clinton
 (See page 537)
 Cohn S. 35 East Main
COX WILLIAM, 17 Front (See page
 538)
 Eli Perry, 74 Front
FURMAN C. E. JR., Main cor. Front
 (See page 592)
GARSON H. & SON, 75 East Main
 (See page 543)
 Garson M. & Co. 14 W. Main
 Hancock John, 32 W. Main
 Hart J. J. 19 East Main
 Hickey J. 90 State
 Hoefen L. 203 North Clinton
KENNEDY JAMES, 8 Mumford (See
 page 537)
 Lipsky M. 28 Front
MCRÖDEN & CO. 23 East Main (See
 page 539)
 Meyer Henry S., Pinnacle av. c. Munger
 Meyer Samuel & Son, 36 W. Main

Miles Henry, 95 South St. Paul
 Moerel E. M. 46 Front
 Moran & Sheil, 11 Front
 MORTON J. & CO. 21 East Main (See page 539)
 Myers Jacob, 8 Front
 NUNNOLD JACOB (boys'), 1 Front (See page 539)
 Nutting A. J. 10 State
 O'Grady D. 98 State
 Priem C. 104 North
 Rice I. Sons, 29 East Main
 Samuel E. Mrs. 18 Front
 Samuel M. 60 Front
 Schaefer Joseph, 50 North Clinton
 Spafford William H. 48 State
 Steger J. B. 223 Brown
 Stein John, 6 Wilder
 STEINFELD E. 15 E. Main (See page 543)
 STORMS GEO. N. 10 W. Main cor. Front (See page 537)
 Tallmage J. A. 11½ Spring
 Wichmann & Kallusk, 7 South avenue

Clothing Cleaners.

Bishop John H. 66 Adams

Cloths.

See Woolen Goods.

Coal.

WHOLESALE.

MACFARLANE JAMES, 33 Powers' bldgs. (See page 601)
 PHILLIPS C. A. & CO. 1 Arcade, (See inside back cover)
 Roberts H. C. & Co. 17 Powers' bldgs.
 YATES A. G. 28 W. Main (See page 600)

RETAIL.

ANTHRACITE COAL ASSOCIATION, H. H. Babcock, agent, 28 and 169 West Main, 7 Plymouth avenue, Ford c. Hill, 51 Hudson (See page 601)
 BABCOCK C. H. 57 Fitzhugh (See page 601)
 BAILEY WELLS S., Alexander cor. canal (See page 599)
 Barron M. 214 State
 BUTLER WM. G., Olean opp. Frost's Nurseries, and 123 West Main (See page 661)
 DELAWARE & HUDSON CANAL CO., W. C. Dickinson, agent, Powers' bldgs. (basement), and Clarissa st. bridge (See page 600)
 ENGERT GEORGE & CO. 149 Exchange and 2 Hamburg (See p. 600)
 Ernst & Schwalb, 19 North avenue
 Forbes S. S. & Son, 11 Hunter
 HILL & FRENCH, 33 West avenue (See page 601)
 Hills E. 66 Hudson
 Kimmel J. & A. 165 Scio
 LANGIE L. C. 56 Hudson and 154 E. Main (See page 599)

MOSER A. M. 117 N. Clinton and 207 S. St. Paul (See front cover)
 Naber Anthony, 72 Chatham
 PALMER N. L. & SON, 83 Allen (See page 598)
 PHILLIPS C. A. & CO. 1 Arcade, West av. opp. Favor, Smith cor. Railroad, 177 S. St. Paul (See inside back cover)
 POLLEY & CROFT, 3 N. Clinton and N. Union c. R. R. (See page 599)
 Reche F. 5 South avenue
 SMITH H. B., West Main c. Exchange and 163 Exchange (See page 600)
 SNELL E. P. & CO. 48 Hudson (See page 599)
 Van Ingen J. 4 West avenue
 WARING & SCOTT, East Main cor. Goodman (See page 649)
 Watters & Doyle, 17 Warehouse
 Wheaton J. 145 Pinnacle avenue
 Wheeler H. P., Litchfield cor. Allen
 Wheeler Josiah, Litchfield cor. Allen
 White James M. 101 Whitney.

Coal Grates.

HEBARD HENRY S. 122 S. St. Paul (See front colored page)

Coffee Mills.

VAN ZANDT B. B. 112 State (See opp. page 550)
 VAN ZANDT M. N. & CO. 11 West Main (See page 573)

Coffin Warerooms.

FOEHNER & MAIER, 4 N. Clinton (See page 568)
 HOFFMAN & MAYER, 10 Allen (See page 568)
 JEFFREYS C. V. 125 State (See p. 608)
 MAXWELL, NEWMAN, McMANIS & CO. 22 South St. Paul (See page 578)
 MUDGE A. W. 121 West Main (See front colored page)

Commercial Agencies.

McKILLOP JOHN & CO. 6 State (See page 507)

Commercial Schools.

WILLIAMS & ROGERS, W. Main c. Exchange (See Schools in Contents).

Commissioners.

See also U. S. Commissioners.

Resident in Rochester, appointed by other States to take testimony to be used, and acknowledgements of Deeds to be recorded in said States.

Eastman J. A. 14 State, for Michigan, New York, Ohio, Pennsylvania, Wisconsin
 WEBSTER EDWARD, 82 Powers' bldgs. (See page 512)

HENRY C. WISNER,

**BACCARAT TABLE DE SERVICE,
 No. 33 STATE STREET.**

Commissioners of Deeds.

For full list of Commissioners of Deeds see Contents.

- DARROW ERASTUS, 67 East Main (See page 518)
- ROBERTS G. H. 6 Elwood block (See inside front cover)
- WEIGEL F. X. 57 North Clinton (See page 569)

Confectioners.

WHOLESALE.

- CULHANE John, 144 W. Main (See page 560)
- McGUIRE JAS. H. 60 West Main (See page 560)

RETAIL.

- Bauer M. 88 St. Joseph
- Beauchamp M. Mrs. 4 Lake avenue
- Bell W. G. 110 Plymouth avenue
- Bouyon P. E. 83 E. Main
- Burgard Sophia, 252 Brown
- Burnett C. A. 189 E. Main
- Button J. L. & Co., Scio near E. Main
- Cook Geo. J. jr. 56 Allen
- Cowan Leonard, 116 St. Joseph
- Countryman A. 9 Arcade
- CULHANE JOHN, 144 W. Main (See page 560)
- Day & Bronson, 133 East Main
- Fleming L. D. 27 E. Main
- Forest Camille, 137 E. Main
- Geir J. L. 37 Monroe avenue
- Graves J. W. 39 Exchange
- Grossman Theresa, 109 North Clinton
- Hauser C. 110 North
- Kendall M. J. 132 State
- Klem George, 165 East Main
- Kramer M. 120 State
- Kreig M. 199 North Clinton
- Linsin John F. 79 North Clinton
- LOVEJOY IRA A. 12 E. Main (See page 566)
- Martin Stephen, 70 Front
- McGUIRE JAMES H. 60 West Main (See page 560)
- Merklinger L. 108 West avenue
- Millman Samuel, E. Main c. North av.
- Morris S. M. Mrs. 93 E. Main
- O'Brien W. S. 50 Exchange
- Schleiffarth F. 316 State
- SOURS W. H. 101 E. Main (See p. 560)
- Stevens John, 19 South avenue
- Teall Isaac, 38 Fitzhugh
- Thrasher Fletcher M. 89 North avenue
- Wamsley Anna Mrs. 100 W. Main
- Wood Anna, 121 N. St. Paul
- Yeomans E. M. 141 East Main

Contractors.

BUILDING.

- ALDRIDGE GEO. W. 51 Powers' buildings (See page 632)
- BLOCK PHILIP, 111 South avenue (See page 641)

- CASE C. W. 35 Goodman (See page 641)
- DEJONGE & MARSIELJE, 34 Buchanan park (See page 640)
- FREIDRICH ADAM, 27 Baden (See page 633)
- HALL GEORGE, Joiner corner Kelly (See page 640)
- HENRICUS MICHAEL & SON, 2 Hanover (See page 590)
- HOWARD H. H. 112 E. Main (See page 636)
- KRAFT & SIEBERT, Ringlestein alley (See page 588)
- LUTHER JOHN, rear 54 North (See page 636)
- MARSON WM. H. 5 Spring (See p. 634)
- MAUDER F. J., Oakman cor. Galusha (See page 633)
- MAUDER JOHN, 271 N. Clinton (See page 640)
- MAXON GEO. L. 10 Tremont pl. (See page 634)
- McELHINNY J. W. 47 Chestnut (See page 633)
- MILES FRANK, Minerva alley (See page 632)
- MILLER & VAN SCHUYVER, 147 West Main (See page 590)
- MURA D. 23 Gorham (See page 640)
- OBERLIES HENRY, Grand c. Bond (See page 637)
- PAPPERT AUGUST, 110 Pinnacle avenue (See page 641)
- PARKER H. D. 63 Broadway (See page 635)
- PIKE J. B., Minerva place (See p. 591)
- RICHARDS WM., Myrtle n. Lyell (See page 635)
- SALTER THOS. 148 Plymouth av. (See page 635)
- SAUNDERS WM. Scott alley (See page 634)
- SIEBERT CASPAR, 105 Pinnacle av. (See page 641)
- STALLMAN BROS. 78 Cady (See page 633)
- STEPHANY JOSEPH, Holland near Nassau (See page 632)
- SUMMERHAYS W. agent, 56 Alexander (See page 587)
- TANNER WILLIAM, rear 196 West Main (See page 634)
- THOMPSON GEORGE H. & CO. E. Main cor. North av. (See page 636)
- TURVER CHARLES H. 39 S. Ford (See page 582)
- WAGNER J. G. 14 St. Joseph (See page 632)
- WAGNER P. & W. agents, 59 Asylum (See page 636)
- WARE J. B. 40 Fulton avenue (See page 635)
- WILLIAMSON R. & W. rear 8 Allen (See page 588)

CANAL.

- WHITMORE, RAUBER & VICINUS, 175 S. St. Paul (See page 659)

FOR MOVING BUILDINGS.

VROMAN & YOUNG, 107 North av.
(See page 651)

RAILROAD.

THOMPSON GEO. H. & CO., E. Main
corner North (See page 636)

STEAM HEATING.

COOK E. H. & CO. 11 Exchange (See
page 617)

STONE.

EHRSTEIN BROS. Oak cor. Smith
(See page 639)

HOLLOWAY & NORMINGTON, 8
West avenue (See page 638)

WHITMORE, RAUBER & VICINUS,
175 S. St. Paul (See page 659)

STREET AND SEWER.

DAVIS DANIEL P. 73 S. St. Paul,
(See page 591)

LAUER F. C. & SON, 35 Powers'
bldgs. (See page 581)

McCONNELL & JONES, 50 Ex-
change (See page 657)

WHITMORE, BRADY & CO. 54
Fitzhugh (See page 653)

WHITMORE, RAUBER & VICINUS,
175 S. St. Paul (See page 659)

Coopers.

BROWN & ROBINSON (*tight*), 30
Canal (See page 678)

Bunker Robert (*tight*), 73 Frank
Campbell James, West near Lyell

Carroll John, 52 Orchard

Dittman P. 12 Martin

Esse Peter, rear 180 Jay

GEDDES W. B., Magne opp. Walnut
(See page 616)

Ginter F. 102 Childs

Hanna Edward, Butler c. Charles

Hanna John, 5 Charles

Hazard James, rear 42 Sherman

HODECKER PHILIP (*tight*), 5 Thomp-
son (See page 678)

Kreiser John, 13 Lime

Lennon James, Plymouth avenue cor.
Bartlett

Little J. M., Magne near railroad

Lovecraft Wm. 92 Allen

McKelvey John, Brown's al. n. Smith

Metzinger John, Ames c. Jay

Miller Peter, 154 Lyell

Picot Nathan, 50 Lowell

Rugroff Joseph, rear 204 Jay

Saffran Conrad, 232 Jay

Skuse Francis N., Finney c. Davis

Tuety G., Smith near Canal

Weis John B. 150 Jay

Weis J. 25 Moore

Wideman M. (*tight*), 74 Whitney

Zwenger Felix, 51 Pinnacle avenue

Copper Plate Engravers.

DODGE & BOYD, 12 E. Main (See opp.
page 640)

Coppersmiths.

MILLINGTON & THOMAS, 2 Ely
(See page 674)

WARRANT & SOUTHWORTH, 26
S. St. Paul (See inside back cover)

Cordage, Twine, &c.

CHURCH SIDNEY, 167 West avenue
(See page 670)

FIELD JAS. 42 Exchange (See p. 648)

Cork Manufs.

TAYLOR & CO. 205 Plymouth avenue
(See page 668)

Corn Doctors.

See *Chiropodists.*

Cornices.

Rose Chas. O. (*window*), 149 N. Water
SIDDONSON JOHN, 90 East Main (See
front colored page)

Corsets.

See *Hoopskirts.*

Costumers.

KUHLMAN JOHN, 3 Oregon (See
page 544)

Oakley A. Mrs. 31 South
Torkinton S. A. 160 West Main

Cotton Batting.

EMERSON WILLIAM, 153 N. Water
(See page 572)

Cotton Mills.

Rochester Cotton Mill, foot Centre

Cracker Machines.

KINGSBURY & DAVIS, Mill near
Factory (See page 680)

Cracker Manufs.

FLECKENSTEIN BROS. Brown cor.
Maple (See page 573)

Cream Tartar.

NEWMAN S. A. at Fairport (See p. 585)

Crockery Ware.

China, Glass and Earthenware.

Braman Sidney S. 135 East Main

Harrold G. W. 84 East Main

McCarthy Wm. 41 East Main

Mutschler H. 81 East Main

NOVELTY SUPPLY CO. 18 Madison
(See page 619)

RANDALL H. S. 51 State (See back
cover)

SCANLIN DANIEL 68 West Main
(See page 628)

SHAFFER H. E. 39 State (See back
cover)

WISNER HENRY C. 33 State (See
foot lines through book)

HENRY C. WISNER,

**MAJOLICA, KIYOTA AND JAPANESE
CHINA, No. 33 STATE STREET.**

Croquet Manufs.

HOWES & BEEBEE, 111½ N. Water
(See page 576)

Curled Hair Manufs.

Schutte John C. 25 Vienna

Curriers.

See Tanners and Curriers.

Cutlers.

Vaessler Max, 113 North Water

Dancing Schools.

See Teachers.

Dental Depots.

Davis & Leyden, 93 State

Dental & Barber Chairs.

ARCHER G. W. 7 North Water (See page 621)

BARTH & ZEISLEIN, 69 North St.
Paul (See page 620)

Dentists.

Beach A. H. 87 East Main

Belding Homer, 45 East Main

Burke E. A. 100 State

Chase J. A. 180 Powers' buildings

Crittenden S. C. 128 Mt. Hope avenue

Decker G. C. 47 East Main

Ellsworth Charles H. 43 State

French Frank, 58 State

Gaskill C. E. 85 East Main

LaSalle B. F. 192 Powers buildings

LINE J. E. 50 Smith's blk. (See p. 513)

Lowe H. N., Front corner East Main

Macy P. 110 State

McGregor B. R. 184 Powers' buildings

Miller H. S. 25 Fitzhugh

Mills C. 11 Masonic Block

Morgan & Schuyler, 55 East Main

Proctor & Allen, 14 State

Requa J. 10 Masonic block

Salter Robert, 78 State

Sanford J. E. 10 Elwood block

Walter L. D. & J. S. 33 Smith's block

WANZER GEO. G. 16 West Main

(See page 588)

WILSON & SMITH, 196 Powers'

buildings (See page 513)

Wood S. G. 89 East Main

Designers.

RAMSDALL GEO. D. 142 Powers'
buildings (See page 520)

Diamonds.

SUNDERLIN & McALLASTER, 18
State (See page 516)

Die Manufs.

HEUGHES J. C. & CO., Mill c. Platt
(See page 662)

Laverty J. 129 North Water •

Die Sinkers.

MORSE C. H. 67 State (See page 625)

Dining Rooms.

See Eating Houses.

Distillers & Rectifiers.

DUFFY W. B. & CO. 8, 10 and 12
White (See page 594)

GOETZMAN FREDERICK, 9 At-
water (See page 562)

NEWMAN JOSIAH (rectifier), 112
Front (See page 561)

Wolcott A. F. & G. P., Clarissa

Doors, Sash and Blinds.

HORCHELER & MILES, Aqueduct
near canal (See page 639)

HUNTINGTON M. & E. 36 E. Main
(See front colored page)

Latz William P. foot of Furnace

O'CONNOR & DEVEREAUX, foot
North Water (See page 639)

Peters Matthias S. 3 Aqueduct

SMITH JOHN A. 13 Warehouse (See
page 651)

Spindler P. H. 65 Nassau

Sweeting Bernard, 34 Joiner

VAN HOESEN S. C. 15 Warehouse
(See page 579)

Wiesner M. 231 Brown

WOODBURY, MORSE & CO. 5 W.
Main (See page 625)

Drain Pipe.

BUTLER W. G., Olean (See page 661)

COPELAND D. JR. 90 South St Paul
(See page 658)

McCONNEL & JONES, Exchange c.
Spring (See page 657)

OTIS & GORSLINE, 51 Powers'
bldgs. (See page 655)

ROCHESTER BRICK AND TILE
MANUF. CO. 51 Powers' bldgs.
(See page 638)

WHITMORE, RAUBER & VICIN-
US, 175 S. St. Paul (See page 659)

Dress Makers.

Adams Nellie Miss, 183 State

Adams Rebecca, 2 Kelly

Allen Margaret, 8 Hickory

Andrews S. W. Mrs. 32 Tremont

Antrim Jane, 85 West avenue

Atchison E. 153 Fitzhugh

Atherton Mary, 45 South Ford

Atkins Esther A. 7 Maple place

Babcock N. T. 11 Sibley's block

Bacon Sarah, 25 Chestnut

Bailey Wells S. Mrs. 12 James

Barnard Lucretia E. 53 Court

Barnhardt Amanda, 2 Charlotte

Barrett Delia, 127 East Main

Baumer Clara, 41 Hudson

Baumer Mary Miss, 5 Leopold

Belknap I. A. Mrs. 11 Cliff

Blondeau A. 6½ Fitzhugh

Borradaile Lizzie, 39 Meigs
 Brown Emily A. 91½ East Main
 Brown Lucy, 139 Monroe av.
 Brown M. A. 20 St. Joseph
 Buchan G. 106½ W. Main
 Bullock Lucy, 15 Joiner
 Burke Lena A. 5 Denning
 Burns Ann Mrs. 2 Smith
 Burrows E. J. 26 Scio
 Burrows Jennie A. 127 State
 Burrows Margaret, 45 Mt. Hope av,
 Cannaby Nancy J. 18 Edinburgh
 Card Harriet E. Mrs. 144 Plymouth av.
 Carmichael Mary E. 57 Mt. Hope av.
 Carroll Mary Miss, 21 Cole
 Casey Ann, 7 Grape
 Cauley Maria L. 11 Frank
 Chipman D. 22 Allen
 Claffy Ellen Miss, 19 Hand
 COFFIN W. H. MRS. 22 East Main
 (See page 546)
 Cook Emily Miss, 50 Saxton
 Courneen Annie E. 33 Lancaster
 Courtney Martha, 52 Howell
 Coy Delia, 8 Rowe
 Crandall Sarah Mrs. 12 Adams
 Curtis Jennie A. Mrs. 17 Scio
 Demarest S. W. 125 State
 Davison Belle, 31 Fitzhugh
 Densmore Louisa Mrs. 1 Erie
 Desmond Margaret, 43 Hickory
 Devlin Susan, 58 Reynolds
 DeWitt Clarissa, 36 South Ford
 Deyo Anna E. 1 Rowley
 Dies Kittie A. 42 Andrews
 Dignin Julia, 71 Lake avenue
 Donaldson Mary, 84 State
 Donoghue Catharine, 60 Reynolds
 Donovan Catharine, 25 Hand
 Dow Ruby, 250 State
 Dugan Mary E. 11 Lime
 Dugan Mary E. Mrs. 95 North avenue
 Dunn Nellie M. 4 Newton block
 Edwards Carrie Mrs. 18 Favor
 Ehde Hannah Miss, 24 Strong
 Eichelberg M. Mrs. 51 Vienna
 Emery Loretta, 58 Allen
 Feagean Lizzie, 249 State
 Field Mary A. 19 Olean
 Finley Margaret, 24 Hill
 Fisher Kate N. Mrs. 33 Scio
 Fitzgibbons B. A. 5 Washington Hall
 Flewett Sarah A. 2 Scrantom
 Follett C. B. 75 East Main
 Fraser Hattie, 11 Gibbs
 Freeman Susan M. 40 Asylum
 Gavin Anna, 91½ Frank
 Genter Delia, 8 Rowe
 Gill Margaret, 27 Vincent place
 Groutage E. T. Mrs. 6 Scio
 Hagan Rosa, 318 State
 Haines Julia E. 18 Allen
 Hair Jennie, 10 Oregon
 Hamill Ella, 238 Exchange
 Hamilton Elizabeth, 11 Edinburgh
 Harrison S. Miss, 43 State
 Hartman & Brady, 18 E. Main
 Hatfield Julia, 9 Lorimer

Hayward Fannie C. Mrs. 42 State
 Heisner Rebecca Mrs. 43 St. Joseph
 Hettig Louisa, 12 Nassau
 Hewitt Libbie, 121 Caledonia av.
 Hough Mary B. 171 Alexander
 Houghton Anna Mrs. 4 Helena
 Howard Mary, 49 State
 Howland Hannah, 11 North Ford
 Hyatt S. A. Mrs. 9 N. Clinton
 Jenner Elizabeth Mrs. 36 Andrews
 Kelly Mary, 5 Mortimer
 Kelly R. A. 14 King
 Kempton K. A. 87 East Main
 Kennedy Mary, 4 Julia
 Kirley Anna E. 9 Ambrose
 Kislingbury Margaret, 5 Jay
 Kist E. C. Mrs. 248 State
 Krant A. C. Mrs. 42 Lancaster
 Lane Mary Miss, 134 East Main
 Larson Georgianna, 19 Atkinson
 Lauer Mary, 185 Alexander
 Lawler M. Miss, 9 Brown's alley
 Lawless Sarah, 54 Reynolds
 Lawrence H. E. Mrs. 19 South
 Line Jennie Mrs. 153 Caledonia av.
 Ling Laura M. Mrs. 23 Stillson
 Luckey Emma A. Miss, McLean near
 Genesee
 Lyons Sarah A. 263 State
 Maddock Elizabeth, 7½ State
 Mallon B. 28 Centre
 Manchester Mary A. 78 Monroe av.
 Mapes Clara J. Mrs. 44 Kent
 McCabe Mary A. 53 West avenue
 McCarthy Abbey, 2 Lowell
 McDonnell Jane Miss, 3 N. Ford
 McEvoy Elizabeth M. 168 State
 McEvoy Maggie F. 168 State
 McGill Sarah M. 3 Magne
 McGinly Rose, 25 Favor
 McGinn I. Mrs. 33 Jones
 McMahon B. E. 22 Scio
 McPadden Bridget, 104½ Caledonia av.
 Mills M. Mrs. 137 East Main
 Monaghan Agnes, 6 Mortimer
 Moore M. J. 38½ Fitzhugh
 Moran Ellen, 49 Hunter
 Mountain Celia F. 40 W. Alexander
 Mountain Elizabeth, 40 W. Alexander
 Murray Annie, 326 State
 Mylacraine Sarah J. 57 University av.
 Needham Eunice Mrs. 102½ Allen
 Neir Ellen, 9½ Jay
 Nelson Catharine A. 42 Hamilton pl.
 O'Brien Mary A. 70 Mt. Hope av.
 O'Hara R. L. 12 East Main
 O'Keefe Margaret, 39 Lyell
 Orchard M. 27 S. Ford
 O'Shaughnessy Margaret, 112 Mt. Hope
 avenue
 Parson A. R. Mrs. 10 Glasgow
 Parsons Kate, 98 State
 Perhamus Mary Mrs. 68 Platt
 Peters Julia, 10 Oregon
 Phelps Emma A. 8 Shamrock
 Pond Elbert Mrs. 6 Jones
 Quick A. L. 114 East Main
 Quinn Margaret, 48 Frank

Rawlings Mary C. Mrs. 53 Jay
 Reardon Mary J., Jay c. Frank
 Redhead J. C. Mrs. 100 Reynolds
 Reily J. W. Mrs. 12 S. Clinton
 Rigney C. 20 North St. Paul
 Ringwood Mary, 2 Lorimer
 Robertson Sarah A. 145 N. Clinton
 Rogers Rebecca, 78 Court
 Rohrbacher Anna M. 217 N. Clinton
 Rolston Mary J. 8 Rome
 Row Augusta, 17 Broadway
 Rowley A. B. 72 William
 Sagendorf Miranda, 80 Weld
 Sheard Mary A. 10 Hamilton place
 Sheldon H. O. 7 Sibley's block
 Shelly E. Mrs. 7 Hubbell park
 Simpson Jane Miss, Briggs' place near
 College

Smith Almira Miss, 26 N. Frances
 Smith Hanna, 19 Palmer's block
 Smith Jennie M. Miss, 256 State
 Smith M. A. 8 Briggs' block
 Smith Richard Mrs. 42 Gorham
 Smith T. J. Mrs. 14 Mortimer
 Spaulding C. A. 43 Atkinson
 Spoor M. Miss, 23 Stone
 Stanley A. M. Mrs. 26 Hudson
 Stark M. E. 29 S. Ford
 Stevenson Mary J. 7 Cypress
 Stowers E. 46 Atkinson
 Sullivan Eliza, 92 Atwater
 Swart Julia A. 55 East Main
 Swarthout Sarah Mrs. 9 William
 Taylor Fannie M. Mrs. 7 Caroline
 Thompson Agnes M. 238 State
 Thrasher M. E. Mrs. 149½ E. Main
 Tobin Eliza Miss, 12 East Main
 Topham Hannah, 82 Caledonia av.
 Trott M. Miss, 45 Lancaster
 Trotter Eliza, 137 East Main
 Tuttle Nellie A. 89 Mt. Hope av.
 VanZandt Margaret, 5 Clinton place
 Vaughan M. A. 55 East Main
 Walter Hannah D. 4 Evergreen
 Welsh Mary L. 7 Kent alley
 Werner Matilda, 196 North Clinton
 Wescott Helen T. 4 Evergreen
 Westcott Phebe B. Mrs., Rowley cor.
 Brighton avenue

White Amelia, 12 Vine
 White Julia A. Mrs. 28 Vose
 Whitney N. A. Mrs. 99 Frank
 Wilder E. C. Mrs. 21 South avenue
 Wilkins Sarah J., Litchfield c. E. Maple
 Willard C. B. Miss, 128 S. St. Paul
 Wilson E. V. Miss, 1 Sibley's block
 Wolcott Sarah Miss, 22 Clarissa
 Wright Harriet, 7 Briggs' place
 Wright Maria F. 45 Andrews

Dress Patterns.

See also Patterns.

JONES & SUGRU, 43 State (See p. 549)

Dress Trimmings.

SARGENT H. D. & CO. 98 E. Main
 (See page 645)

VOGT A. 44 Exchange (See page 645)

Drill Manufacturers.

GLEASON WM., Brown's race (See
 page 686)

Druggists.

AMAN HENRY, 139 East Main (See
 page 569)

Bassett A. G. 350 State
 Battelle W. H. & Co. 61 East Main
 Bickford James jr. 208 East Main
 Bryan J. L. 176 West Main
 COOLIDGE BROS. 124 East Main
 (See page 568)

Cooper J. & J. 128 East Main
 Cowley Edward A. 236 Brown
 Curran & Goler, 96 West Main
 DAVIS E. H. 81 State (See front cover)
 HAASS G. H. 38 East Main (See back
 cover)

HAMBLETON A. 111 Plymouth av.
 (See page 569)

HEWITT FRANK L. 44 South av.
 (See page 570)

HIBBARD S. A. 134 East avenue
 (See page 569)

IRISH J. P. 255 State (See page 570)

Johns George W. 110 N. Clinton
 Kobbe H., N. Clinton c. Atwater
 Mannel Gustavus, 31 Front
 Marsh Edwin T. 90 Plymouth avenue
 Morse & Chambers, 134 State
 Newman S. A. 115 East Main

PAINE C. F. & CO. 20 & 22 West
 Main (See front cover)

Pfaff Frederick, 118 State
 Post J. K. & Co. 4 Exchange

REESE & HASKIN, 66 West Main
 (See front cover)

Rowley John, 51 Monroe avenue
 Schmitt Joseph M. 108 North av.

STEVENS C. E. 62 West av. (See p.
 570)

Taft Bros. 146 West Main
 WEIGEL FRANCIS X. 57 North
 Clinton (See page 569)

Weishaar M. 84½ North

Druggists' Sundries.

TAYLOR & CO. 205 Plymouth avenue
 (See page 668)

Dry Goods.

WHOLESALE.

BURKE, FITZ SIMONS, HONE &
 CO. 53 E. Main (See page 545)

MANN A. S. & CO. 17 State (See top
 end of book)

SIBLEY, LINDSAY & CURR, 73 E.
 Main (See page 549)

RETAIL.

Amiet Amelia Mrs. 5 Lowell
 Amsden J. F. & Son, 36 State

BURKE, FITZ SIMONS, HONE &
 CO. 53 E. Main (See page 545)

Cappon Abram J. 98 North avenue
 Corlett Eliza, Court cor. Chestnut

Dunlap J. Boyd, 87 Monroe avenue
 Englert Peter A. 201 North Clinton
 Genzler John, 88 South avenue
 Goldsmith Bros. 85 St. Joseph
 Goldwater N. & Bro. 134 St. Joseph
 Greve Frederick, 107 Caledonia av.
 Guggenheimer Julia, 33½ Monroe av.
 Hastings & Toole, 264 State
 Helfer Nicholas, 140 N. Clinton
 Hetzler J. G. 75 Chatham
 HICHBORN & CO. 13 E. Main (See page 546)

Hunter James, 23 Monroe avenue
 Keifhaber John H. 221 East Main
 Long M. 32½ Scio
 Mahle Louis, 68 St. Joseph
 MANN A. S & CO. 17 State (See top end of book)

Miller Mary, 53 North avenue
 Rouchel Mary, 35 Front
 Scheib Joseph, 233 North
 Schoellhorn L. 160 Jay
 SIBLEY, LINDSAY & CURR, 73 E. Main (See page 549)

Smith F. H. 79 East Main
 Straszner Jacob, 238 Brown
 Stuart J. H. 13 East Main
 Tichner Solomon, 83 Chatham
 Vay E., King corner East Maple
 Vosburgh W. J. 86 West avenue
 Watson E. W. Mrs. 57 Lyell
 Walter A. 131 North avenue
 Young Charles, 62 Monroe avenue

Dusters.

Russell T. C. & Co. 116 Plymouth av.

Dyers and Scourers.

Blondeau Gaston, 2 Chestnut
 Dunn S. & Co. 40 Mumford
 LEARY D., Mill corner Platt (See page 580)
 Nicholson George, Kelly cor. Joiner
 Robinson Wm. J. 77 S. St. Paul

Eating Houses.

Baker John E. 4 Railroad avenue
 Brewer S. S. 3 Front
 Buckley R. A. 7 South St. Paul
 Dolanty M. 36 Mill
 Hulbert O. S., Front cor. East Main
 Kaufman Jacob. 42 Allen
 Kennelly M. H. 29 Powers' bldgs.
 Kimpal C. F. 5 Mill [ion, 8 E. Main
 Women's Christian Temperance Un-
 Worden S. C. 36 West Main

Edge Tool Manufs.

BARTON D. R., Tool Co. Mill cor.
 Furnace (See page 676)
 GREGG M. foot of Falls (See page 676)
 Horton Charles T., N. Water
 Mack & Co. 136 Mill
 ZIEGLER LOUIS & CO. foot North
 Water near railroad (See page 673)

Electrotype Foundry.

BRIGGS & BRO. 91 State (See p. 534)
 LENNOX JAS. 24 Front (See page 521)

Elevator Builders.

GRAVES L. S., Mill cor. Factory (See page 690)
 MICHEL F. P., Mill opp. Platt (See page 685)

Embroidery Stampers.

Bassett Henriette, 140 State
 HANNA J. B. 44 State (See page 546)
 ZELLWEGER BROS. 117 W. Main (See page 544)
 Zellweger J. C. 154 Brown

Engine Builders.

WOODBURY, BOOTH & PRYOR,
 Mill near Platt (See page 687)

Engravers.

DODGE & BOYD, 12 East Main (See opp. page 640)
 Edmonds J. B. 88 Powers' bldgs.
 EVENING EXPRESS PRINTING
 CO. 23 W. Main (See opp. p. 528)
 FRAUENBERGER G. (wood), 59 Ar-
 cade (See page 517)
 Gifford C. C. (metal), 16 Elwood block
 Kinsey Edwin F. (wood), 20 W. Main
 LOCKHART & LEADLEY (wood),
 24 East Main (See page 577)
 Purcell E. B., Mill cor. Exchange
 RAMSDELL GEORGE D. 142 Pow-
 ers' bldgs. (See page 520)

Engravings.

WOODWARD C. W. 126 State (See page 532)

Excursions.

BENNETT S. & SON, Buell avenue
 (See page 647)

Expresses.

American, 83 State
 United States, 35 Exchange
 CITY EXPRESSES.
 DECKER FRANK (baggage), at N. Y.
 C. R. R. depot (See page 572)
 PRATT & WEED (baggage), 92 Mill
 cor. R. R. (See page 604)
 STONE JOHN S. & SONS, 106 W.
 Main (See page 604)

Extracts.

VAN ZANDT B. B. 112 State (See opp. page 550)

Fancy Dry Goods.

WHOLESALE.

Arnold S. J. & Co. 101 State
 FAHY J. & CO. 64 State (See p. 545)
 SHATZ, LOWENTHAL & LEITER,
 40 State (See page 545)
 SWEETING J. B. 84 State (See un-
 der Calendar)

RETAIL.

Cauley C. & Co 55 State
 Engelmann Linda, 253 N. Clinton
 Graham K. T. 91 E. Main
 Gwynne Mary I., Frank c. Jones av.
 Hammond Wm. C. 104½ West av.
 Hebing Christina, 31 Grand
 Henry Jesse Mrs. 3 Montrose
HICHBORN & CO. 13 E. Main (See page 546)
 Jones John B. 48 South avenue
 Landbeck Catharine, 41½ N. Clinton
 Maloney M. J. 94 State
 Mason A. Mrs. 30 Bolivar
 McCormick Mary, 30 Saratoga av.
MCDOWELL & CO. 53 State (See page 547)

Messmer Geo. 295 North Clinton
 Michelsen F. 51 North Clinton
 Miller Henry, 35 North avenue
 Oldfield M. Mrs. 36 Lake avenue
 Olmsted & Stracham, 95 E. Main
PENNY E. A. 111 East Main (See page 547)

Peters Mary A. 1 Grand
 Popp M. Mrs. 131 Jay
 Rohrbacher C. 217 N. Clinton
 Sanborn C. M. 66 South avenue
 Schaefer Barbara, 111 N. Clinton
 Schoelz Fred. 188 North Clinton
 Shelton Mary A. 11 Conkey avenue
 Smith Elizabeth Mrs. 44 South av.
 Steinmann Lina, 84 St. Joseph
 Turner Mary A. 320 State
 Underhill G. Mrs., Tremont c. Plymouth avenue
 Wardwell E. J. & Co. 64 W. Main
 Williams Alfred, 203 East Main

Fancy Goods (Toys, &c.)

Benjamin S. M. 89 East Main
HUGHES M. L. 110 State (See page 507)
 Jacobs & Hughes, 166 West Main

Fence.

See Iron Fence.

File Manufs.

Irwin J. S. & Co. 107 Mill
 Ladwig C. foot Furnace
 Stott Bros. Mill near Centre
STOTT G. F., River near N. Water (See page 581)

Filter Manufs.

INGRAHAM W. L. 77 Exchange (See page 513)
 Ranney J. A. 8 Exchange place

Financial Agents.

McPHAIL & JONES, 69 Arcade (See page 508)

Fire Engines.

SINTZENICH E. B. 12 S. Water (See page 674)

Fire Extinguishers.

Phelon J. M. & Co. 55 West Main

Fire Works.

CULHANE JOHN, 144 West Main (See page 560)

Fish and Oysters.

Arnold C. & Co. 41 Front
PALMER DWIGHT, 76 Front (See back colored page)
PEART & BOORMAN, 64 West av. (See page 554)
TEALL A. 79 Caledonia avenue (See page 555)
WAYTE WM. E. 104 West Main (See page 554)

Fishing Tackle.

See also Sporting Apparatus.

Judson & Co. (rods), 139 North Water
 Ratcliffe James, 14 Arcade
 Tangneuy Robert, 11 Smith's Block

Flavoring Extracts.

Gordon, VanZandt & Co. 50 Exchange

Florists.

BECKWITH H. & J. K. at Brighton (See page 527)
BRIGGS & BRO. 91 State (See page 534)
CHARLTON JOHN, University av. (See page 527)
CROSMAN BROS. 300 Monroe av. (See page 516)
FROST & CO., Plymouth av. c. Frost avenue (See front cover)
GOULD BROS., East avenue (See back cover)
 Heath H. C. 288 East Main
HOOKER H. B. & CO. 255 North St. Paul (See page 526)
HOOKER H. E. & BRO., East avenue near Goodman (See front cover)
KELLER JOHN B. Mt. Hope av. near cemetery (See page 527)
KING WM. & SON, 123 Mt. Hope av. (See page 526)
 Lawrence D. T., Monroe avenue
LITTLE W. S., East avenue (See back cover)
 Long Charles, 98 Frances
 Newdale M. & Son, Colvin
PARCE J. Y. at Fairport (See p. 579)
VICK JAMES, 60 State cor. Market (See page 533)
WHITE BROS., Thurston n. Chili road (See page 583)
YALE. T. B. & CO., East avenue (See page 559)

Flour, Grain, &c.

See also Flouring Mills.

Adsit Franklin, 70 West avenue
 Bainbridge J. P. 43 Exchange

BASTABLE & McDONALD, 42 Allen
 (See page 557)
Britton A. P. 153 S. St. Paul
Brown William, 109 Lyell
Bubser J. J. 100 South avenue
Collins H. C. & Co. 2 Plymouth av.
DUNLEVY & DELAVAU, 28 Allen
 (See page 574)
ELLWOOD & ARMSTRONG, rear 7
 W. Main (See page 598)
Fairchild Myron S. 126 Lake avenue
Fertig John, 135 North Clinton
Fleischer H. J. 124 St. Joseph
Frost C. J. 87 Plymouth avenue
Geimer Jacob, 244 North Clinton
Giles Samuel, 210 West Main
Giles William, 137 West Main
Griibroek Albert, 72 Hudson
Hahn J. B. 52 South St. Paul
HAWLEY GEORGE, 102 West av.
 (See page 554)
Hayton Joseph. 34 South avenue
Heberling T. & Co. 51 Monroe avenue
Hilbert George, North av. n. Caspar
HILL C. B., South Water (See page 552)
Johnston Robert, State cor. Smith
Kreckman F. 51 North
Lang Carl, 59 St. Joseph
LOEBS DANIEL, 105 Hudson and 14
 Allen (See page 552)
Mandle Joseph, 27 Hanover
Medbury Thomas, 52 West avenue
Mertz Christian, 54 Front
MERZ G. F., Brown's race n. Factory
 (See page 552)
Morphy David, 114 St. Joseph
Morphy John, 230 North Clinton
MOSELEY & MOTLEY, Mill foot
 Brown (See page 552)
Moser Fred. 111 North av.
Newborn S. R., S. St. Paul cor. Court
PAINE & MILLS, 49 North Clinton
 (See page 555)
PERCY GEO. W. 40 Allen (See p. 557)
Peter Peter, 116 Pinnacle avenue
Rauber Stephen, 155 West Main
SCHERMERHORN J. V. N. 64 North
 avenue (See page 561)
Simmelink & Van Ness, 71½ Hudson
Spohr L. F. 126 East Main
Steward G. H. & Co. 199 Monroe av.
Steyaart Isaac, 94 North avenue
Vogt Frederick, 62 Front
Wegman Balthasar, 39 North avenue
Wells Jerome B. 220 E. Main

Flouring Mills.

Campbell James, Brown's race
Chase, Bristol & Viele, 5 Aqueduct
Cornell J. 33 North Water
Davis, Jennings & Co., Brown's race
EXCELSIOR MILLS, Ellwood &
 Armstrong, rear 7 West Main (See
 page 598)
Farley, Ferguson & Wilson, Mill
**FLOUR CITY MILLS, MOSELEY
 & MOTLEY**, Mill foot Brown
 (See page 552)

Gerling Bros. 3 North Water
HILL C. B., South Water, (See p. 552)
Hinds J. A., Brown's race
McMillan Wm. S., South Water
Pentecost J. R. & Co. 1 West Main
**PEOPLE'S MILLS, GEORGE F.
 MERZ**, Brown's race n. Factory
 (See page 552)
Richardson William, Brown's race
Smith & Chester, Mill foot Brown
Wilson James & Co., South Water
Wilson & Ashton, 125 North Water
Wilsons & Pond, South Water

Flower Pots.

HAMMER JOHN M. 151 West av.
 (See page 576)

Flower Preservers.

LOGAN M. B. 52½ N. St. Paul (See
 page 520)

Forwarders.

Fish & Heath, Fitzhugh near canal

Fountains.

SIDDONS CHAS. S. 96 East Main,
 (See inside front cover)

Frame Manufs.

LOCKHART JAMES, 121 State (See
 page 525)

Freight Agents.

See also Agents.

Cummings W. H., Platt corner Kent
FELL A. agent "Blue Line" 166 State
 (See Railroads in Contents)
HARRIS B. F. (Erie railway), 4 State
 (See Railroads in Contents)
HOYT WILLIAM B., Railroad avenue
 Canada Southern (See Railroads in
 Contents)
LEWIS R. S. (M. C. R. R.) 95 Waver-
 ley block (See Railroads in Contents)

Freight Deliverers.

HAHN GEO. 13 Andrews (See p. 604)
LEE F. A. 4 State (See page 605)

Fresco Painters.

LEMPERT LEON H. 9 Howell (See
 page 591)

Fruit.

Domestic and Foreign.

Aldrich A. & Co., 143 State
CLARK W. N. 120 W. Main (See page
 554)
Curtice Bros. & Mack (preservers), N.
 Water
HALL R. D. & CO. 177 E. Main (See
 page 551)
HEMINGWAY H. F. & CO. 123 State
 (See page 575)
Morris David, 93 East Main

Fruit Jars.

SHAFFER H. E. 39 State (See back cover)

Fruit Plates.

DEWEY D. M. 8 Arcade (See page 523)
Sargent D. W. 22 Exchange
THOMPSON J. W. & CO. 18 Palmer's block (See page 527)

Furnaces, Ranges, &c.

See also *Stoves and Tinware.*

CAMPBELL JAS. 83 Exchange (See page 626)
CO-OPERATIVE IRON FOUNDRY (manufg.), 8 Hill (See page 614)
GEDDES WM. B. 29 Exchange (See page 616)
GOMMENGINGER & CO. 48 Exchange (See page 617)
TROTTER & STONE, 29 Exchange (See page 626)
WARRANT & SOUTHWORTH, 26 S. St. Paul (See inside back cover)

Furniture.

See also *Cabinetmakers.*

BARTH & ZEISLEIN, 69 North St. Paul (See page 620)
BURLEY & DEWEY, 88 State (See page 629)
Goss & Margrander, 53 State
HARLFINGER CHAS. (repairer), 129 North Clinton (See page 628)
HAYDEN C. J. & CO. 184 State (See page 613)
HUNN, SPENCER & CO. 74 State (See page 612)
IRVING A. G. (repairer), N. Water (See page 629)
MICHELSEN & RUCKDESCHEL, Mill foot Brown (See page 624)
SCHANTZ, MINGES, SHALE & CO. 17 North Water (See page 622)
SCHIFFNER A. 50 East Main (See page 629)
VETTER AUGUST & CO. 149 North Water (See page 620)
VEYHL & BARTHOLOMEW, 9 Front (See page 622)
WEGMAN J. B. & CO. 44 East Main (See page 629)

Furriers.

KENYON & HUNT, 100 State (See page 541)
Kollofski A. C. 92 State
MARION F. H. 58 State (See page 538)
STERN L. 73 Mill (See page 548)
Wolcott M. Miss, 22 Clarissa

Game Manufs.

HOWES & BEEBEE, 111½ N. Water (See page 676)

Gardeners.

Cook Thomas 166 West av.

Gas Companies.

CITIZENS' GAS CO. 15 North St. Paul (See page 493)
ROCHESTER GAS LIGHT CO. Mumford (See page 492)

Gas Fitters.

See also *Plumbers.*

BEACH J. S. 17 Mill (See page 625)
BENNETT RICHARD, 8 Mumford (See page 643)
Connolly G. W. & Co. 153 East Main
Paulus J. 8 South St. Paul
SHERLOCK & SLOAN, 25 Exchange (See page 623)

Gents' Furnishing Goods.

WHOLESALE.

BEEMER M. V. 18 West Main (See page 541)
Bier, Stern & Co. 66 Mill
Exstein Hiram & Co. 54 Mill

RETAIL.

BEEMER M. V. 18 West Main (See page 541)
Cone & Kendall, 11 East Main
Eddy A. M. CO. 31 East Main
Ocumpaugh E. & Bro. 17 East Main
Peoples John L. 178 State
Ranney & Baker, 20 State

Glass Manufs.

GATCHELL & CO. 178 Plymouth av. (See page 668)

Glass Mould Manufs.

SCHAFFER J. C. 3 Hill (See page 684)

Glass Stainers.

BOOTH, RIESTER & CO. 29 Pearl street, Buffalo (See page 586)

Gloves.

PRITCHARD A. R. & LIKLY, 78 State (See foot lines through book)

Glue Manufs.

Chapin E. B., Wolcott near Rapids
Rothgangel & Co., Erie canal near Brighton line

Gold Platers.

MORRIS J. M. 14 State (See page 514)

Grain Elevators.

Whitney Geo. J., Brown c. Erie canal

Grain Separators.

ERDLER & OLIVER, Mill cor. Brown (See page 586)

A. R. PRITCHARD & LIKLY,

**FINE MOROCCO SATCHELS,
No. 78 STATE STREET.**

Granite.

- HEBARD HENRY S. 122 S. St. Paul
(See front colored page)
 PITKIN PETER, 22 West avenue
(See page 660)
 POWERS JAS. 97 N. St. Paul *(See page 646)*

Gravel Roofers.

- ROBINSON WM. 48 Exchange *(See page 642)*

Grocers.

WHOLESALE.

- BREWSTER, GORDON & CO. 80 E. Main *(See page 550)*
 BREWSTER H. & CO. 72 E. Main *(See page 551)*
 BREWSTER H. A. & CO. 6 South St. Paul *(See page 550)*
 BUELL GEORGE C. & CO. 36 Exchange *(See page 551)*
 SMITH, PERKINS & CO. 16 Exchange *(See page 550)*

RETAIL.

- Abeles David 100 South avenue
 Adwen S. W. at Brighton lock
 Albert Joachim, 101 Chatham
 Atkinson William, Clifton c. Summer
 Backus J. M. 69 West Main
 Baeurle Jacob, 108 East avenue
 Baker James, 144 North
 Ballou H. S. 161 East Main
 Bartell Henry, 178 West avenue
 Barry John, 76 South avenue
 Barton James, 73 Lake avenue
 Bartlett A. C. 164 State
 BASTABLE & McDONALD 42 Allen *(See page 557)*
 Bauman Frederick J., Monroe avenue corner Union
 Bauman John, 146 Plymouth avenue
 Bayer Lioba Mrs. 306 N. Clinton near Clifford
 Beikirch Jacob, 186 Pinnacle avenue
 Bernhard & Son, 80 Lyell
 Biel Anthony, 116 Pinnacle avenue
 Boddy John W. 210 E. Main
 Bohrer Louis, 102 North
 Bornkessel C. J. 100 Scio
 Bradler Frank X. 16 Hanover
 BREWSTER H. A. & CO. 6 South St. Paul *(See page 550)*
 BREWSTER H. & CO. 72 East Main *(See page 551)*
 Brichler C. B. 194 Exchange
 Brooks Benjamin, 62 Broadway
 Brown Geo. H. 116 State
 Brownell A. D. 327 State
 Brownell G. 8 Hunter
 Brueck George, 119 South avenue
 Buchterkirch August, 31 Vienna
 Buhlmann Henry W. 105 North av.
 Bullinger B. jr. 6 Elizabeth
 Burkard John B. 26 Delevan
 Burkard John M. 103 South avenue
 Burk Catharine D. 114 East avenue

- Butler W. A. 57 Spring
 Byrne M. 182 W. Main
 Cain B. 341 State
 Caring Frank W. 101 North Clinton
 Clark John, 111 Hunter
 CLARK W. N. 120 W. Main *(See page 554)*
 Cochrane Charles, 149 N. Clinton
 Cochrane William, 69 Jay
 Consler Joseph, 81 Caledonia av.
 Conway J. 314 State
 Coogan Celia, 17 Hand
 Corbusier & Nagle, 54 South av.
 Cork Alfred H. 151 E. Main
 Corris Wm. R. 222 E. Main
 Costello T. S. 196 Exchange
 Cotchefer Richard, 94 Plymouth av.
 COTTRELL & STEVENSON, 13 Spring *(See page 555)*
 Crowell Walter S. 93 Caledonia av.
 Crowley Dennis, Seward c. Champlain
 Cunningham Mary Mrs. 108 Jay
 Curran P. H. 56 Spring
 Curtis & Co. 90 West Main
 Cushman A. H. 280 State
 Daly R. A. 249 State
 Daus Matthew, 62 Lyell
 Deavenport & Hale, 163 East Main
 Deegan Patrick, 331 State
 DeGarmo Robert, 69 West av.
 De Mallie John, Hudson c. Vose
 Donivan J. 34 South St. Paul
 Donnelly S. 168 State
 Doran E. M. 110 Caledonia av.
 Doyle Rosanna, 65 Caledonia av.
 Draude E. Mrs. 27 Orange
 Dubelbeiss S., Bay cor. North av.
 Duffy Cornelius, 33 West Alexander
 DUNLEVY & DELAVAU, 28 Allen *(See page 574)*
 Dwyer M. 102 Caledonia av.
 Dykins Philip jr. 136 Plymouth av.
 Eagan Patrick, 55 Prospect
 Edgar Joseph, 138 N. Clinton
 Eichman Louis, 148 East Main
 Eisenburg Conrad, 174 Pinnacle av.
 Eisenmann M., North av. cor. Clifford
 Eisenmenger M., 37 Broadway
 Ely Andrew, 114 West av.
 Emer Stephen, 131 Scio
 Enders J. C., Frances cor. Frost av.
 Englert Anthony, 258 N. Clinton
 English A. R. 94 Caledonia av
 Erler William, 71 Hudson
 Fahrer John, Smith cor. Saxton
 Farber George J., North av. c. Caspar
 Farrell M. J., Plymouth av. c. Bartlett
 Feebery & Heberling, 222 W. Main
 Ferner John, 138 Lake av.
 Ferner Leonard, 204 North
 Fien Louis, 192 N. Clinton
 Finzer Valentine, 99 Chatham
 Fisher George, 110 E. Main
 Flanagan M. 8 West avenue
 Flint John E. 10 1/2 North av.
 Fœhner George, Lime cor. Orchard
 Fox Jacob, 137 North Clinton
 Francis Alexander S. 84 Monroe av.

HENRY C. WISNER,

**WHITE CHINA DINING and TEA SETS,
 No. 33 STATE STREET.**

Frank George F., North c. Woodbury
 Frank Gregor, Monroe av. c. Goodman
 Frank Theodore, 94 Meigs
 Frankénburger Enos, 18 Hebard
 Fritz J. G. 177 North St. Paul
 Fryers R. 120 Oak
 Gannon Michael jr., Scio cor. Davis
 Gannon M. K. 144 North St. Paul
 Gardner Thomas, 9 Magne
 Gates H. P. 347 State
 Gavagan M., Lime cor. Orchard
 Gay Robert, 17 Weld
 Genrick John, 76 St. Joseph
 George Frederick, Smith cor. Saxton
 Gerstner William, 209 Scio
 Gleason Jas., University av. c. Anderson
 avenue
 Gleichauf John, 89 Monroe av.
 Goedel Charles, 119 Lyell
 Goers Theodore, 103 Hudson c. Rhine
 Goetzman H. 9 South avenue
 Gould & Co. 29 West avenue
 GRAHAM L. D. 33 Ontario (*See page*
 590)
 Gray C. W. 136 State
 Gray James C. 143 East Main
 Green C. W. 49 Monroe avenue
 Green Philip, E. Main n. University av.
 Greene George W. 37 Lyell
 Hall L. J. & Bro. 98 East avenue
 Haller C. 104½ Hudson
 Halpin Edward, 142 East Main
 Halpin James H. 53 North avenue
 Hamilton & O'Connell, 194 State
 Hammond J. 152 West Main
 Harmon M. C. Mrs. 13 Lowell
 Hart Samuel & Co. 333 State
 Hastings & Toole, 264 State
 Haungs M. A. Mrs. 278 Brown
 Hawkins George B. 17 Reynolds
 HAWLEY GEORGE, 102 West av.
 (*See page 554*)
 Hayes J. & Co. 22 South St. Paul
 Healy Daniel, 161 Scio
 Heller Joseph, 24 William
 Henkel G. H., Mt. Vernon avenue
 Herberger Martin Mrs. 214 N. Clinton
 Herrmann Mary, 134 Hudson
 Hesslinger & Stallknecht, 228 W. Main
 Hetzel Charles F. 156 North av.
 Hetzel William, 116 Mt. Hope av.
 Higgins Catharine, 229 Plymouth av.
 Hoehn George jr. 152 North av.
 Hof Louis, 392 Brown
 Hoock Florentine, Frances c. Hunter
 Hopwood R. F. 165 West Main
 Hubeli A., St. Joseph cor. Vienna
 Huels J. H., Hudson near Alphonse
 Hunter George, 23 Lake avenue
 Hussey T. M. 37 Monroe av.
 Hyde E. F. & Co. 64 East Main
 James T. E., Clifton cor. Frances
 Jesserer Aloise, 85 Hunter
 Joiner Martin, 297 State
 Jones H. W. 38 South St. Paul
 Joslin Thomas M. 156 State
 Justice R. & J. H. 146 Brown
 Kane James jr. 21 Monroe avenue

Kase J. E. 267 Plymouth avenue
 Kase Nicholas, 108 Orange
 Kase Peter, 7 Wilder
 Keenan J. M. 37 Smith
 Kelly T. Peter, 162 Exchange
 Kennelly J. 38 Front
 Kenning T. J. 50 North av.
 Kenny Rosanna Mrs. 7 Bloss
 Kessler J. H. 28 Mumford
 Kilpeck Martin, 108 Cady
 Kimmel A. 43 North avenue
 Kitzel Michael, 71 Lowell
 Klein John, 83 Frances
 Kleisle Simon, 21 Lowell
 Knapp Victor, 36 Sputh avenue
 Knell F. 140 Hudson
 Knope A. T., Saratoga av. n. Montrose
 Knope Joseph, 107 Oak
 Koesterer Henry, 116 North av.
 Koesterer, J. C. 41 Andrews
 Kohl Charles, Lowell cor. Martin
 Konath G. 128 Lyell
 Kondolf Henry, Ames near Jay
 Kostbahn Gustav, 69 Mt. Hope av.
 Kramer Valentine, 206 N. Clinton
 Kraus Peter, Jay opposite Ames
 Kuefer F. C. 32 St. Joseph
 Kuenzi Samuel, 66 Delevan
 Laforce V. 307 North Clinton
 Lampert Bernard, Frost av. c. Reynolds
 Lavigne Zebulon, Saratoga av.
 Lehman H. 126 Lyell
 Leidecker G. F. 291 N. Clinton
 Lennon James, Plymouth av. c. Bartlett
 Loweth C. W. 77 Adams
 Lyddon Thomas J. 19 Clifford
 Lynch John, 75 South avenue
 Lynch Thomas, 66 Frances
 Maher John, 44 Romeyn
 Mahon John, Frances cor. Tremont
 Mahoney Thomas, 270 Plymouth av.
 Marks Hugh, 98 North St. Paul
 Marts William, 38 Smith
 Martin Anthony H., Lyell cor. Childs
 Mathews Patrick, 89 Lyell
 Mathewson A. J. 17 Monroe avenue
 MAURER GEORGE C. 78 East Main
 (*See page 595*)
 May Adam, 99 W. Maple
 May Frank N., Colvin c. Campbell
 May Gustav, Reynolds cor. Bartlett
 May Martin, 82 West Maple
 McAnarney Thomas, 142 Brown
 McCabe O. E. 53 West avenue
 McCormick Catharine, 147 Lyell
 McDade Andrew, 346 State
 McDonald C. 2 Lake avenue
 McDowell John, 128 East avenue
 McElrone Rebecca S. Mrs. 131 S. St.
 Paul
 McGee James, 110 East avenue
 McGrath Patrick, 83 Mt. Hope avenue
 McGregor W. J. 32 Prospect
 McKenna John, 260 State
 McMahon Martin, Martin cor. Lowell
 McMannis James, 24 S. St. Paul
 McMannus Edward, 96 East avenue
 McMillan Thomas, 107 Plymouth av.

A. R. PRITCHARD & LIKLY,

*Gloves, Canes, Etc., a Large Stock,
 No. 78 STATE STREET.*

McMurray Sam'l, Reynolds c. Hunter
 McSweeney Eliza, 135 S. St. Paul
 Merlau Conrad, 42 Lake avenue
 Merlau F. H. 330 State
 Merz J. F. 33 Gregory
 Meyer Catharine, 18 Hanover
 Meyer John & Son, 88 Plymouth av.
 Miller Charles, Campbell c. Orchard
 Miller R., Atwater corner N. St. Paul
 Minges Frederick J. 58 Scio
 Minges John, 240 East Main
 Mitchel William, 232 State
 Moffitt Delia Mrs. 226 State
MOGRIDGE JOHN, 23 Spring (*See page 575*)
 Monroe Peter L. 53 Frances
 Mooney J. B. 216 State
 Moore Charles, 57 Hunter
MOORE & COLE, 72 West Main (*See page 574*)
 Morgan Ellen, Tremont near canal
 Mudgett J. W. 91 North avenue
 Muehl Christian, 54 Lyell
 Mumbach M., West Maple cor. Saxton
 Nagle Jacob, 8 West avenue
 Nagle John, 113 St. Joseph
 Neuhart Michael, 229 East Main
 Newton T. A. 144 East Main
 Niven William H. 134 West Main
 Normile Henry, 19 Smith
 Nunnold Catharine, 247 N. Clinton
 O'Keefe A. 204 State
 O'Loughlin J. 147 Brown
 O'Neil F. 36 S. St. Paul
 O'Reilly J. 111 Champlain
 Otto Joseph A. 136 North St. Paul
 Pacaud A. M. A. 92 Kelly
PAINE & MILLS, 49 North Clinton (*See page 555*)
 Pauckner J. L. 123 Mt. Hope avenue
 Peachey Charles, 276 State
PERCY GEORGE W. 40 Allen (*See page 557*)
 Pitkin J. M. & Co. 75 East avenue
 Platt Joseph, 109 Genesee
 Pope Wm. 16 East avenue
 Popp John, Meigs corner Caroline
 Popp Otto C. 119 Jay
 Post Myron, 78 Alexander
 Predmore H. at weighlock
 Pritchard Marquis, E. Main c. East av.
 Ramsey Peter B. 93 Lake avenue
 Rasser C., Brown corner Allen
 Reichert Jacob, 87 Hudson c. Baden
 Reinhard Peter, 97 Mt. Hope avenue
 Reuter George, Meigs cor. Park avenue
 Rice Alvah, 103 West avenue
 Ries J., Childs corner Jay
 Ringwood John, 118 Adams
 Ritz Ferdinand, 91 North Clinton
 Rodenbeck A. & W. 37 North avenue
 Roth & Co. 4 South avenue
 Ruby George Mrs. 184 West avenue
 Salmon Charles, 45 Andrews
 Schaad Philip, 116 South avenue
 Schaefer Elizabeth, 24 Joiner
 Schaefer & Bro., Reynolds cor. Adams
 Schaefer C. 105 Lyell

Schaeffer John J. 103 North Clinton
 Schafer J. M. 20 West avenue
 Schaffer Jacob, 168 Plymouth avenue
 Scheidnagel A., Hudson c. Bernard
 Scherer F., Childs corner Jay
SCHERMERHORN J. V. N. 64 North avenue (*See page 561*)
 Schleifer John, 92 Chatham
 Schlitzer Isador, 82 North avenue
 Schlitzer Leo, 54 S. St. Paul
 Schnell Albert, 40 Caroline
 Schnorr Jacob, 1 Baden
 Schooley Edward, 42 Monroe avenue
 Schreck Adolph, 127 Scio
 Schroedel August, 9 Hawkins
 Schwab G. 128 S. St. Paul
 Schwab Rosa Mrs. Whitney c. Smith
 Schwing Wm., Whitney cor. Orange
SEAMAN STEPHEN, 116 East Main (*See page 556*)
 Seel Adam, 622 West avenue
 Seel Christian, 70 Jay
 Seely F. C. 41 Monroe avenue
 Sell John A. 12 Lake avenue
 Seiler Jacob, Campbell cor. Whitney
 Semple A. M. 4 West Main
 Shcdd K. P. 102 West Main
 Sheldon P. 241 North Clinton
 Sheridan Peter E. 186 West Main
 Sholtus R. K. 92 East avenue
 Shorer Basil, 5 Hudson
 Sichel Abraham, 71 N. Clinton
 Simmons J. 70 Bartlett
 Simmons M. B. 95 East avenue
 Smith John, 43 Orange
 Smith John T. 82 North St. Paul
 Stahl Martin H. 143 South avenue
 Stahlhut Henry, 36½ Gregory
 Stallman Mary, 73 Adams
 Steele F., Allen c. N. Washington
 Stephan J., St. Joseph c. Buchan park
 Stetzenmeyer F. 171 Plymouth avenue
 Stickel Frekerick, 31 Herman
 Stierly S., North avenue cor. Stevens
 Stiles David L. jr. 49 North av.
 Stiles W. J. & Son, 61 Caledonia av.
 Straub John, 126 Lake avenue
 Struck Charles, 69 St. Joseph
 Stuermer John, Bay cor. First avenue
 Swift & Williams, 57 South Clinton
 Thiem Charles, 14 Hawkins
 Thomas Adam, 254 State
 Thompson J. 126 Plymouth avenue
 Thompson & Lamb, 289 State
 Trant Jeremiah, 16 Ward
TRAUGOTT WM. 35 Scio (*See p. 556*)
 Trost Joseph, 172 Pinnacle avenue
 Uebel Harmon, 39 Reynolds
 Ulrich Fred. 69 Monroe avenue
 Van Valkenburgh H. S. 54 Platt
 Verhoeven Michael A. 30 S. St. Paul
 Voelkl Joseph, Ames c. W. Maple
 Vogel & Mueller, 40 Front
 Wagner John, 88 Jay
 Wahl M. 34 Herman cor. Thomas
 Wait Israel C. 17 Jones
 Waldert L. 77 South av. c. Munger
 Wallace John A. 6 Lake avenue

HENRY C. WISNER,

**REAL AND FRENCH BRONZES,
 No. 33 STATE STREET.**

Walter Anthony, 231 North
 Ward Caroline, Adams c. Prospect
 Warfield R. N. & Co. 195 Monroe av.
 Warren H. N. 1 Hudson
 Weber Geo. P. 61 Atwater c. Chatham
 Wegman Ann, 182 N. St. Paul
 Weidenboerner L. 64 Monroe avenue
 Weider Philip, 34 Grand
 Weining John, 60 Lowell
 Welch James G. 115 University av.
 Weldele Catharine Mrs. 87 Jay
 Wells & Parker, 68 West avenue
 Wendover Henry, 18 South avenue
 Werden Bros. 234 East Main
 Werth Peter, 69 Reynolds
 Wheeler John W. 24 Hunter
 Whiting A. N. & Son, 260 East Main
 Wick Henry, 274 Brown
 Wickens & Beattie, 1 Lyell
 Widman J. Charles, 136 and 138 St.
 Joseph
 Wigney William B. 14 Jones
 Wild Charles, 243 State
 Winter Henry, 115 Pinnacle avenue
 Witherspoon W. & Son, 106 W. Main
 Woodruff S. R. 93 East avenue
 Wright George, 60 Adams
 Wulschleger F. G. 184 West Main
 Yawman George, Jay cor, Orchard
 Yeoman Matthew, 74 West avenue
 Young J. 64 Troup
 Young & Pasch, 53½ Kelly
 Zeweisig Joseph, 98 Scio
 Zimmer Conrad F. 111 Mt. Hope av.
 Zimmer H. & W. 84 Atwater
 Zurn Philip, Orange cor. Orchard

Gunsmiths.

Billingshurst William, 41 East Main
 Green Charles, 3 West Main
 Werner O. F. 40 East Main

Hacks.

See Stables.

Hair Dressers.

Bing Geo. 2 South Clinton
 BLOXSOM A. C. 319 State (*See p. 568*)
 Bloxson Josiah H. 2 Railroad avenue
 Bruce W. H. 5 Exchange
 Button Thomas, 13 Exchange
 Cooper C. 59 Jay
 Cunningham F. S. 43 East Main
 Ebel Christopher, 32 Mill
 Egerer Joseph, 162½ North
 Eichelman C. W. 3 Mill
 Filkins & Winterroth, 14 Powers' bldgs.
 Gaertner M. 94 North Clinton
 Gerhardt Frank, W. Maple c. Saxton
 Gibbs O. S. 154 North
 Gilder Lewis, 110 North avenue
 Goetz George M. 86 St. Joseph
 Griffin & Reichert, 1 South St. Paul
 Haight Isaac, 214 West Main
 Haight William, 22 Exchange
 Hanss Valentin, 159 East Main
 Hassel Francis J. 227 N. Clinton
 Heiness Unies, 47 North Clinton
 Hoeret A. L. M. 88 East Main

Hunt C. & H. 48 West avenue
 Islep George, 215 North Clinton
 Jenkins J. B. 34 Exchange
 Johnson H. G. 148 West Main
 Kase George, 227 Brown
 Kase V. 7 Wilder
 Keiling William, 123 North Clinton
 Koch George, 90 Mill
 Koerner Christian, 43 South St. Paul
 Krapf B. 252 State
 Laird & Berger, 1 Corinthian Hall bldg.
 Lynch & Arnold, 11 South avenue
 Marsh J. J. 5 Arcade
 Meng J. D. 10 Wilder
 Menges Charles, 111 Mt. Hope avenue
 Meyer Frank J., Whitcomb House
 Miller Peter G. 58 Lyell
 Miller Peter J. 130 North St. Paul
 Miller William, 112 Caledonia av.
 Miller W. & Son, 6 Mumford
 Montgomery R. 339½ State
 Oakley Monroe, 107 Plymouth avenue
 Reichert Peter, 228 East Main
 Riebel J. N. 83 West avenue
 Roesser Joseph, 235 State
 Ruf Thomas, Grand cor. Whalin
 Sackett & Popp, 29 Arcade
 Saller & Schlitzler, Brackett House
 Schaefer Edward P. 87 St. Joseph
 Scheib John, Elm cor. E. Main
 Schoen A. 100 East Main
 Schoenfelder A. 53 Monroe avenue
 Schrier G. J. 127 State
 Schultz F. Louis, 113 St. Joseph
 Stahley Casimer, 98 Front
 Stoeppler William, Congress Hall
 Vaeth J. 106 North Clinton
 Van Maaren Henry, 78½ North
 Vogt Peter, 108 East avenue
 Wager & Renner, 2 North St. Paul
 Werner Edward, 196 North Clinton
 Wheler J. C. 261½ N. Clinton
 White A. 192 West Main
 Witzigman Joseph, rear 173 North
 Young J., Market corner Front
 Zeller Emil, Hudson corner Clifford

Hair Work. (Ornamental.)

Austin M. Mrs. 26 Stone
 Calhoun C. Mrs. 82 State
 Cunningham A. M. Mrs. 58 Saxton
 Egan & Mack, 4 Elwood block
 Griffin C. S. W. Mrs. 56 State
 Johnson A. B. Mrs. 35 Oak
 LOGAN M. B. MRS. 52½ North St.
 Paul (*See page 520*)
 Lynch & McMullen, 5 Baker's block
 Mahle E. Mrs. 6 Vienna
 Maltby J. W. Mrs. 118 University av.
 McQuillen M. A. Miss, 378 Brown
 Minges S. C. Miss, 17 Swan
 Reynolds M. C. Miss, 70 State
 Showers A. F. Miss, 413 Brown
 Stessel Agnes Mrs. 16 Walnut
 Sullivan Josie, 2 Sibley's block
 Turner B. Mrs. 131 East Main
 Vaeth Louisa, 106 North Clinton
 WACKERMAN M. 90 State (*See p. 515*)

Hand Stamps.

ALLEN & WEGMAN, 62 East Main
(See opp. page 592)

Hardware.

BURKE WILLIAM & CO. 12 West Main (See page 631)
ERNST L. 3 W. Main (See page 630)
HAMILTON & MATHEWS, 21 W. Main (See page 630)
Hebing Henry S. 74 East Main
Hill J. H. 29 West Main
KINGSLEY H. A. & CO. 112 East Main (See page 631)
McKindley J. W. 25 West Main
POLLOCK, WEAVER & CO. 17 W. Main (See page 631)
ROBY S. B. & CO. (carriage and saddlery), 80 State and 43 Mill (See page 607)
SEIFRIED F. & CO. 13 West Main (See page 630)
Snow J. & S. 79 State
SWIFT & GORDINIER, 335 State (See page 631)

Hardware Manufs.

Byam E. C. & Son, 155½ N. Water
HEMINGWAY HENRY N. 150 N. Water (See page 679)
Keyes & Munn, 9 Platt

Harness Makers.

Ashby Edward, 46 West avenue
Brooks Thomas, 20 Market
Connell D. A. 102 East avenue
Ernst P. 59 Front
Gutberlet N., South St. Paul cor. Ely
Hahn & Dunn, 179 East Main
Hall J. O. 281 State
Hart James, 241 State
Hertel J. W. 4 Sophia
Lux Jacob, 5 Market
Meisch Charles, 638 West avenue
Mooney William, 25 S. St. Paul
Olive George, Lake av. n. Ridge road
PAGE GEO. B. & SON, 98 East Main (See page 609)
Reibstein J. H. 51 South St. Paul
SMITH A. V. & CO. 65 State (See page 605)
Spillman Frederick, 244 East Main
Van Dusen, 103 East Main
Vogt M. 153 North avenue
Weniger A. H. 79 Exchange
Weniger Henry, 128 East Main
Wirley Frederick, 121 State
Young Jacob, 72 Monroe avenue

Harness Oil.

VACUUM OIL CO. 128 Powers' bldgs.
(See page 681)

Hat Manufs.

BUCKLEY RICHARD B. 62 E. Main (See page 542)
Hoefler C. B. 12 East Main

ODENBACH JOHN, 49 State (See page 540)
ODENBACH & SHALE (jobbers), 7 State (See page 541)
VAN VECHTEN J. W. & CO. 35 State (See page 579)
Yauch J. 20 Elwood block

Hats, Caps and Furs.

WHOLESALE.

KENYON & HUNT, 100 State (See page 541)
Rice & Wolff, 49 Mill
STERN L. 73 Mill (See page 548)

RETAIL.

Goggin & Jones, 77 East Main
Guggenheimer S. 5 East Main
KENYON & HUNT, 100 State (See page 541)
Kollofski B. R. 92 State
MARION F. H. 58 State (See page 538)
Meng C. 13 State
ODENBACH J. 49 State (See page 540)
ODENBACH & SHALE, 7 State (See page 541)
Sabey & Son, 97 East Main
Seyler M. A. 70 State
Taylor J. & Sons, 13 Front

Hay.

Beck Frances, 213 State
Bidwell C. H. 79 Front
Fiske L. E. foot White
Wilson H. E. 38 Andrews
Zimmer F. & Co. 78 Front

Health Lift.

Hastings William M. M. 54 State

Hearse Manufs.

CUNNINGHAM J. & SON, 3 Canal,
(See page 610)

Hides.

See also Leather; also Tanners.

FRITZSCHE FRANK, 43 Front (See page 665)

Hoisting Machinery.

SCHAFFFR J. C. 6 Hill (See page 684)

Hoop Skirts and Corsets.

Niblack S. H. Mrs. 156 West Main
Turner J. Mrs. (corsets), 28 Sophia
Tuttle & Persons (corsets), 172 W. Main
Winters Bridget, 224 East Main

Horse Collars.

Acker & Stewart, 77 State
Lighthouse J. C. 129 State
PAGE GEO. B. & SON, 98 East Main (See page 609)

Horse Furnishing Goods.

PAGE G. B. & SON, 98 East Main,
(See page 609)

HENRY C. WISNER,

PARIAN BUSTS AND FIGURES,
No. 33 STATE STREET.

Horse Shoe Nails.

Boyle William, 17 Martin

Horse Shoers.

McKENZIE J. C. & CO. 1 Allen,
(See page 558)
MELVIN JAMES, 4 S. Washington,
(See page 605)

Hotels.

American Hotel, 84 Exchange, J. R. Roderick
Ayers' Hotel, 82 Mill, J. K. Chipps
Bantel Hotel, 332 State, G. W. Crissy
Bellevue Hotel, 100 East avenue, J. R. Hayd
Boehm's Hotel, 101 Mill, Collins & Morgan
Brackett House, Mill near railroad depot, Samuel M. Hildreth & Co.
Burns' Hotel, 102 Mill, P. Burns
CHAPMAN HOUSE, 44 South St. Paul, Geo. H. Clute (See page 567)
City Hotel, 78 S. St. Paul, W. S. Lee
Clinton Hotel, 28 Exchange, Isaac Ashley & Co.
Congress Hall, Railroad avenue corner Mill, James Terry
Enniskillen Hotel, 362 State, T. Flanagan
European Hotel, Fitzhugh near West Main, B. M. Baker
Farmers' Hotel, East Main corner Elm, N. P. Wilbur
Genesee Avenue House, 280 North St. Paul, John C. Moore
GLEN HOUSE, foot of lower falls, S. Bennett & Son (See page 647)
Globe Hotel, Lake Avenue opp. Ridge road, Leander Whitford
Goulding's Hotel, 96 South St. Paul
Lake Avenue Hotel, 159 Lake avenue, J. F. Boyd
Lee's Hotel, Goodman cor. railroad
McLean's Hotel, Mill corner Centre, Owen McLane
Mechanic's Hotel, 10 Platt, M. Cummings
Mt. Hope avenue House, 120 Mt. Hope avenue, Rudolph Weis
National Hotel, West Main corner Fitzhugh, B. L. Sheldon
Niagara House, 154 State, Mrs. Mary Johnson
North American Hotel, State corner Brown
OSBURN HOUSE, East Main corner North St. Paul, Bromley & Co. (See page 567)
Park House, Rochester Driving Park, James H. Stutson
Plymouth avenue Hotel, 88 Plymouth avenue, Philip McConnell
Reed House, 77 Mill, M. Reed
Reinfeld House, Lake avenue near Ridge road, C. Reinfeld
Sprague's Hotel, 100 Mill, J. P. Stringham

St. Nicholas House, Front c. Mumford, Peter Hess
Tremont House, 81 Mill, B. Schmitt
Union Hotel, 54 West avenue, J. W. Breakey
Waverley House, State cor. Railroad avenue, Walbridge & Maxwell
WHITCOMB HOUSE, 110 E. Main, Whitcomb & Crouch (See page 567)
Wimble House, 85 Mill, Matthew Slaven
York House, Front cor. Market, Mrs. M. Cleminson

House Furnishing Goods.

CAULKINS W. R. & CO. 32 E. Main (See page 507)
NOVELTY SUPPLY CO. 16 Madison (See page 619)

Ice.

Allen Thomas B., Lewis near Scio
EMERSON WM. 322 N. St. Paul (See page 572)
FINCH C. H., Rowe near canal (See page 571)
FOOS JOHN, 126 Lyell (See page 571)
GOETZMANN HENRY, 19 Pinnacle avenue (See page 555)
HORTON PLATT, 136 State (See page 571)
Hotchkin G. N. & Sons, 175 Exchange
KING HIRAM T. 21 Ward (See page 559)
Simpson T., Lake avenue
Tripp E. W. 6 Frost avenue

Ice Cream.

JOSLIN T. M. 156 State (See page 571)
SOURS WM. H. 101 E. Main (See page 560)
TEALL ISAAC, 38 Fitzhugh (See page 560)

Ink Manufs.

ALLING F. D. 19 Mill (See page 593)

Insole Manufs.

ROCHESTER INSOLE MANUF. CO. 75 N. Water (See page 667)

Insurance Agents.

See also Agents.

AMSDEN C. T. & SON, Powers' bldgs. (See page 505)
BUSH DANIEL W. 8 Exchange place (See opp 503)
HOLMES W. F. & CO. 2 Masonic blk. (See page 510)
McLEAN & JOHNSON, 26 Arcade (See page 500)
REIBLING & OLCOTT, 62 E. Main c. South St. Paul (See page 510)
ROBERTS G. HENRY, 6 Elwood blk. (See inside front cover)
ROWLEY & HAYES 8 State (See page 505)

STOWELL C. L. 132 Powers' bldgs.
(See page 504)
TYLER C. M. 40 East Main (See page 510)
WARD L. A. & L. F. 2 & 4 Exchange place (See page 502)
WARD & CLARK, 31 Powers' bldgs.
(See page 509)
WELCH & FIRMAN, 12 Smith's blk.
(See page 506)
WILSON P. S. 1 Arcade (See page 508)

Insurance Companies.

ROCHESTER GERMAN INSURANCE CO., Rudolph Vay, sec. Rochester Savings Bank bldg. (See page 691)

Insurance Companies,

Having Agencies in Rochester.

See also Agents.

ÆTNA INSURANCE CO. L. A. & L. F. Ward, agents, 2 Exchange pl. (See page 502)
AMERICAN POPULAR LIFE INS. CO., Geo. Breck, agent, 22 Exchange (See page 509)
BANGOR INSURANCE CO., C. L. Stowell, general agent, 132 Powers' bldgs. (See page 504)
BRITISH AMERICA ASSURANCE CO., C. L. Stowell, general agent, 132 Powers' bldgs. (See page 504)
BROOKLYN LIFE INS. CO., A. I. Hulett, agent, 45 Powers' bldgs. (See page 506)
COMMERCIAL UNION ASSURANCE CO., D. W. Bush, agent, 8 Exchange place (See page 503)
CONTINENTAL LIFE INS. CO., W. H. Montgomery, manager, 13 Powers' bldgs. (See page 510)
GERMANIA FIRE INSURANCE Co., D. W. Bush, agent, 8 Exchange place (See page 503)
LYCOMING FIRE INSURANCE Co. Rowley & Hayes, agents, 8 State (See page 505)
MUTUAL LIFE INSURANCE CO. Rowley & Hayes, agents, 8 State (See page 505)
NEW JERSEY MUTUAL LIFE INS. CO., A. J. Gordon, manager, 18 West Main (See page 506)
NEW YORK LIFE INSURANCE AND TRUST CO. L. A. & L. F. Ward, agents, 2 Exchange place (See page 502)
QUEEN INSURANCE CO., D. W. Bush agt. 8 Exchange place (See page 503)
WATERTOWN FIRE INS. CO. Welch & Firman, ag'ts, 12 Smith's block (See page 506)

Intelligence Offices.

Candee H. O. 56 Arcade
Crouch M. A. Mrs. 147 S. St. Paul
Laidlaw Mary A. Mrs. 1 Prospect

Inventor.

PAGE C. D. 17 East (See page 694)

Iron and Steel.

See also Hardware.

BURKE WM. & CO. 12 West Main (See page 631)
GALUSHA N. H. (pig), 20 Court (See page 693)
ROBY S. B. & CO. 80 State (See page 607)
SWIFT & GORDINIER, 335 State (See page 631)

Iron Bridges.

LEIGHTON BRIDGE AND IRON WORKS, Leighton av. (See back colored page)

Iron Columns.

CHENEY W. H. 106 S. St. Paul (See page 652)
SHORER & TAILLIE, 145 N. Water (See page 682)

Iron Fence.

BRIGGS M. & SON, 188 State (See page 681)
KOHLMETZ H. 121 N. Water (See page 677)
PALMER T. G. 87 Front (See page 662)

Iron Founders.

BRIGGS M. & Son, 188 State (See page 681)
Burke P. & Co. 206 State
CO-OPERATIVE FOUNDRY CO. 8 Hill (See page 614)
GALUSHA NORMAN H. 20 Court (See page 693)
HEMINGWAY H. N. 150 N. Water (See page 679)
JONES EZRA & SON, Brown's race foot of Furnace (See page 683)
SHORER & TAILLIE, 145 N. Water (See page 682)
SILL STOVE CO. 187 West Main (See page 615)

Iron Furnaces.

Ontario Iron Co. 90 Mill
Rochester Iron Manuf. Co., E. Jones, president, 33 Mill

Iron Roofers.

GOMMENGINGER & CO. 48 Exchange (See page 617)
SIDDON'S JOHN, 90 East Main (See front colored page)

HENRY C. WISNER,

KEROSENE CHANDELIERS, BRACKETS, and LAMPS--No. 33 STATE STREET.

Iron Vases.

CO-OPERATIVE FOUNDRY, 8 Hill
(See page 614)
PALMER T. G. 87 Front (See page 662)
SIDDONS CHAS. 96 East Main (See
inside front cover)

Jewelers. (Manufs.)

See also Watches, Jewelry, &c.

Brown B. E. 14 State
Cohn Hermon C. 71 Mill
Elsheimer L. P. 15 Smith's block
Martens Wm. G. 16 Elwood block
Schleber H. H. 88 Powers' bldgs.
WOLTERS C. F. 30 W. Main (See p.
577)

Junk Dealer.

Coxon George, 90 Front
MILES HENRY & CO. 83 S. St. Paul
(See page 669)

Kindergarten.

ROCHESTER REAL SCHULE, 7
Mortimer (See Schools in Contents.)

**Kitchen Furnishing
Goods.**

Sanford M. B. 121 East Main

Knit Wool Goods.

LOWENTHAL & ETTENHEIMER,
10 Mumford (See page 544)

Lace Repairers.

CASEY J. H. Mrs. 19 Kent (See p. 547)

Ladies' Furnish. Goods.

Danzig Bros. 1 E. Main
McDOWELL & CO. 53 State (See page
547)
MOSELEY H. M. & WIGHTMAN
(suits), 7 East Main (See page 547)

**Ladies' Underwear
Manufacturers.**

Chamberlain & Abbott, Court c. Stone
aseltine, Cowen & Co. 14 Exchange
MOSELEY H. M. & WIGHTMAN
7 East Main (See page 547)
SIBLEY, LINDSAY & CURR, 73 E.
Main (See page 549)

Lambrequins.

VEYHL & BARTHOLOMEW, 9
Front (See page 622)

Lamp Dealers.

Goodale & Pells, 65 West Main
RANDALL H. S. 51 State (See back
cover)
WISNER H. C. 33 State (See foot lines
through book)

Lamp Manufs.

BUFFALO STEAM GAUGE & LAMP
CO. 31 State (See front colored page)
KELLY LAMP WORKS, Mill corner
Furnace (See page 689)

Last Manufs.

Boddy T. jr. 123 Mill
DUFNER J., Mill near Factory (See
page 663)
Shepard W. W. 81 North Water

Laths.

HOLLISTER & CO. 102 Exchange
(See page 656)

Laundresses.

Hammer Amelia, 3 Swan
Stewart Fanny D. 7 Swan
Weaver Mary Ann, 7 Swan

Laundries.

BEEEMER M. V. 18 West Main (See
page 541)
Brooks Margaret Mrs. 222 State
BRUCE W. H. 5 Exchange (See p. 567)
Condlln Mary J. 111 East Main
Downs M. J. & Co. 155 W. Main
Gee Sam, 100 East Main
Hagen & Myers, 4 North Clinton
Lee Wau, State

Law Blanks.

ANDREWS E. R. 1 Aqueduct (See op-
posite page 512)
WILLIAMSON & HIGBIE, 62 West
Main (See page 518)

Lawn Mowers.

VICK JAMES, 60 State (See page 533)

Lawyers.

Adams Walter W. 78 Powers' bldgs.
Allen Bros. 113 Powers' buildings
Andrews J. S. 42 Powers' buildings
Angle James L. 31 State
Armstrong Geo. 1 Court House
Bacon Theodore, 74 Powers' buildings
BAKER C. S. 116 Powers' buildings
(See page 512)
Baker W. H. 62 Arcade
Barker H. L. 14 State
Barton A. L. 117 Powers' buildings
Bates & Pike, 61 Powers' buildings
Beach D. B. 105 Powers' buildings
Benedict L. C. 124 Powers' buildings
Benedict O. M. 47 Powers' buildings
Bennett Horace L. 42 Arcade
Bennett J. B. 198 W Main
Benton & Dickinson, 84 Arcade
Binney Omar, 129 Powers' buildings
Bowman W. H. 90 Powers' buildings
Briggs M. H. 76 Powers' buildings
Budlong S. J. 124 Powers' buildings
Carpenter W. R. 37 Arcade
Chumasero & Davison, 158 Powers'
buildings

Clark & Clark, 98 Powers' buildings
 Cochrane J. C. 90 West Main
 Cogswell & Perkins, 18 Powers' bldgs.
 Colwell J. A. 90 W. Main
 Craig Oscar, 58 Powers' buildings
 Crandall P. M. 40 Arcade
 Crittenden DeL. 15 Powers' buildings
 Curtis H. R. 99 Powers' buildings
 Danforth & Shepard, 43 Powers' bldgs.
 Davis Z. L. 61 Arcade
 Davy & Luckey, 106 Powers' buildings
 Dean C. F. 19 Smith's block
 Delano Fred. 22 Arcade
 Deuel J. W. 96 Powers' buildings
 Draper George P. 36 Powers' buildings
 Dunning J. M. 85 Powers' buildings
 Durand F. L. 54 Powers' buildings
 Eastman & Van Voorhis, 14 State
 Edmonds Wm. E. 16 Smith's block
 Ely Alfred, 28 Powers' buildings
 Fanning & Williams, 86 Powers' bldgs.
 Farrar & Lysander, 14 State
 Feely D. C. 83 Powers' buildings
 Fenner E. B. 2 Baker's block
 Fiske E. B. 37 Powers' buildings
 Foote N. jr. 25 Arcade
 Garlock James S. 38 Arcade
 Gillette L. H. 108 Powers' buildings
 Goddard L. J. 71 Powers' buildings
 Gorham C. H. 23 Powers' buildings
 Graebe Wm. 36 Powers' buildings
 Harris & Cooke, Fitzhugh c. W. Main
 Hills Isaac, 16 Powers' buildings
 Hitchcock F. A. 14 State
 Hovey & White, 65 Powers' buildings
 Hulett P. B. 62 Arcade
 Humphrey H. & G. H. 112 Powers' buildings
 Husband T. B. 111 Powers' buildings
 HUSBANDS J. D. 143 Powers' bldgs.
 (See page 512)
 Hutchinson F. B. 52 Arcade
 HYDE D. C. 91 and 93 Powers' bldgs.
 (See page 512)
 Jackson G. F. 84 Powers' buildings
 JEFFRES J. H. 116 Powers' buildings
 (See page 512)
 Jordan James A. 37 Arcade
 Lansing R. H. 31 State
 Macumber F. A. 78 Powers' buildings
 Martindale & Oliver, 42 Powers' bldgs.
 Mathews J. S. 109 Arcade
 Maxson & Simons 119 Powers' bldgs.
 McAlpine B. D. 58 Arcade
 McDonald & Raines, 1 Court House
 McDowell C. I. 31 State
 McGorray J. A. 90 West Main
 McIntyre P. 70 Arcade
 McKinney M. G. 159 Powers' bldgs.
 McMath E. A. 101 Powers' buildings
 McNaughton & Olmsted, 21 Arcade
 McPHAIL & JONES, 39 Arcade (See page 508)
 McPherson W. J. 40 Arcade
 Montgomery T. C. 75 Powers' bldgs.
 Morgan J. S. 24 Powers' buildings
 Munger G. G. 72 Powers' buildings
 Nash Chauncey, 36 Arcade

Noyes M. 18 Smith's block
 O'Brien J. C. 110 Powers' buildings
 O'Kelly T. P. 16 Powers' buildings
 O'Regan J. C. 71 Arcade
 Palmer John P. 117 Powers' buildings
 Perry Chauncey, 48 Arcade
 Pomeroy J. N. 37 Meigs
 Powers C. J. 52 Powers' buildings
 Rau J. 10 Smith's block
 Rawson G. W. 18 Smith's block
 Redfield Henry S. 23 Arcade
 Ripsom G. E. 81 Powers' buildings
 Robinson S. R. 85 Powers' buildings
 Roe John E. 19 Powers' buildings
 Rowley & Johnson, 41 State
 St. John Wm. H. 106 Powers' bldgs.
 Sargent Henry, 46 Arcade
 Satterlee & Yeoman, 53 Powers' bldgs.
 Schooley R. H. 159 Powers' buildings
 Selden H. R. 76 Powers' buildings
 Shepherd Jesse, 56 Powers' buildings
 Sheridan Wm. J. 7 Baker's block
 Sill G. W. 34 Powers' buildings
 Smith V. M. 140 Powers' buildings
 Spahn Jacob, 49 Arcade
 Staples W. S. 109 Arcade
 Stebbins J. W. 100 Powers' buildings
 Stevens O. H. 50 Powers' buildings
 Stull J. A. 52 Arcade
 Sullivan J. 1 Court House
 Sully D. H. 58 Arcade
 Terry S. H. 81 Powers' buildings
 THOMAS G. W. 109 Powers' bldgs.
 (See page 511)

Townsend & Sullivan, 90 Powers' bldgs.
 Truesdale George, 111 Powers' bldgs.
 Tucker & Bowen, 19 Smith's block
 Van Epps J. C. 10½ South St. Paul
 Van Voorhis John, 77 Powers' bldgs.
 Van Voorhis Quincey, 77 Powers' bldgs.
 Varnum J. P. 58 Powers' buildings
 Webb W. W. 9 Powers' buildings
 WEBSTER E. 82 Powers' buildings
 (See page 512)
 Wentworth D. 67 Powers' buildings
 White H. E. 45 Arcade
 White R. E. 42 Arcade
 Whittlesey F. A. 73 Powers' bldgs.
 Wilcox S. G. 60 Powers' buildings
 Wile & Wile, 12 Powers' buildings
 Wilkin A. J. 90 West Main
 Williams C. 105 Powers' buildings
 Wilson J. W. 90 Powers' buildings
 Wood Daniel, 24 Arcade
 Wooden L. M. 108 Powers' buildings
 Woodward H. H. 1 Baker's block
 Yerkes W. H. 56 Powers' buildings

Leather and Findings.

See also Tanners and Curriers.

ALLING BROS. 51 North Water (See page 665)
 Boor Francis J. 47 Mill
 CARING, WEICHER & CO. 87 N. Water (See page 665)
 FRITZSCHE FRANK, 43 Front (See page 665)

KALB, HAHN & CO. 5 Mumford (See page 667)
 LAMPERT H. 81 North Water (See page 667)
 Wilson H. 130 Front

Libraries.

Athenæum, 40 Fitzhugh
 Central Library, Free Academy bldgs.

Lime Manufs.

BUTLER W. G. Olean, opp. Frost av. (See page 661)
 COPELAND D. Jr. 90 South St. Paul (See page 658)
 LAUER F. C. & SON, 35 Powers' bldgs. (See page 581)
 MAY HORACE, 90 South St. Paul (See page 658)
 McCONNELL & JONES, Exchange cor. Spring (See page 657)
 Nellis J. H., Plymouth avenue

Liquors, Wines, &c.

BECK GEORGE (native), at Charlotte (See page 580)
 Bussey Geo. H. 65 E. Main
 Castle Chas. D. 68 East Main
 Coats R. 9 Exchange
 Cook R. 34 Marshall
 DUFFY W. B. & CO. 10 White (See page 594)
 Fee James & Bros. 26 North Water
 Friederich John H. 36 Front
 GOETZMANN F. 9 Atwater (See page 562)
 HOWARD J. O. 114 State (See page 563)
 Kaufman & Felsing, 170 West Main
 Leary & Co. 92 West Main
 LORD JARVIS & CO. 67 Mill (See page 593)
 Matthews & Servis, 86 West Main
 McCarthy F. 128 State
 Mendonsa M. S. 65 West avenue
 NEWMAN JOSIAH, 112 Front (See page 561)
 O'NEIL & DEMPSEY, 342 State (See page 562)
 Phillips & Fuller, 1 North avenue
 Pierce W. 92 East Main
 Rigney Matthew, 43 E. Main
 Rosecrants H. 124 State
 Rosenfield N. 7 Atwater
 ROSENTHAL G. 107 North avenue near Atwater (See page 562)
 SAYER J. 132 W. Main (See page 561)
 Smith Chas. R. 32 Exchange
 STAPE JOHN, 104 East avenue (See page 556)

Lithographers.

DODGE & BOYD, 12 East Main (See opp. page 640)
 ENNECKER & KARLE, 35 State (See opp. page 624)
 MENSING, RAHN & STECHER, 7 Market (See opp. page 544)

Livery Stables.

See Stables.

Lock Makers.

SARGENT & GREENLEAF, Court c. Stone (See front colored page)

Locksmiths.

Mann Nathaniel, 29 S. St. Paul
 Roch Jules, 7 Andrews
 Wray & Elwood, 34 Mill

Looking Glasses.

See also Picture Stores.

TURPIN FRED. 110 Front (See page 583)
 WOODWARD C. W. 126 State (See page 532)

Lumber.

BENNETT & BARRY, 140 Lake av. (See page 639)
 BRONSON AMON & SON, Exchange opp. Troup (See page 652)
 CAMERON & CHACE, 19 Warehouse (See page 653)
 CHAMBERLAIN & MORDOFF, State cor. Platt (See page 624)
 CHASE & OTIS, west end Court st. bridge (See page 653)
 Cook F. C. & Co. 311 State
 Cooke C. T., North cor. Franklin
 CRAIG & CROUCHS, Griffith near South St. Paul (See page 637)
 CROUCH G. W. & C. T., S. St. Paul cor. Griffith (See page 637)
 De Puy T. (wholesale), 150 Lake avenue cor. Rowe
 EDGERTON HIRAM H. 207 South St. Paul opp. Griffith (See page 637)
 HOLLISTER & CO. 102 Exchange (See page 656)
 Hough Norman, (thin) 92 Allen
 McGraw & Co. 73 Alexander
 MORSE W. B. & CO. 30 West avenue (See page 652)
 PRENTICE ALEX. & SON, 158 Lake avenue (See page 650)
 Scrantom & Co., Hunter cor. Olean
 Spencer J. E. & Co. 21 Plymouth av.
 WARING & SCOTT, East Main cor. Goodman (See page 649)
 Whitbeck J. B. 176 Plymouth avenue

Machine Brushes.

COONEY W., Aqueduct (See page 669)

Machinery Oils.

VACUUM OIL CO. 128 Powers' bldgs. (See page 681)
 WILLIAMS & BASSETT, 85 Exchange (See page 680)

Machinists.

MACHINERY, TOOLS, JOBBING, & C.
 BEISHEIM HENRY, 145 N. Water (See page 674)

A. R. PRITCHARD & LIKLY,

Gloves, Canes, Etc., a Large Stock,
 No. 78 STATE STREET.

Brettell F. S. & Son, Brown's race
CLAGUE, RANDALL & CO. 1 Aqueduct (See page 677)
CONNELL & DENGLER, 123 Mill cor. Furnace (See opp. page 551)
 Curran & Johnson, 4 Janes
 Dougherty & Dorsey, 130 Mill
 Emrich E. S. 149 North Water
ERDLE FRED. 129 Mill (See page 672)
GLEASON WM., Brown's race (See page 686)
GRAHAM J. S. & CO., Mill n. Factory (See page 672)
GRAVES L. S., Mill cor. Factory (See page 690)
GREENWOOD JOHN & CO. 124 Mill near Furnace (See page 688)
 Hand E. 2 East Main
 Heughes J. C. & Co., Mill cor. Platt
JONES EZRA & SON, foot Furnace (See page 683)
 Judson J. & Son (*Governors*), 116 Mill
KIDD IRON WORKS, Wm. Gleason, propr. Brown's race near Furnace (See page 686)
KINGSBURY & DAVIS, Mill near Factory (See page 680)
 Kohlmetz Henry, 121 N. Water
 McCutchen John, 108 State
MICHEL F. P. foot of Platt (See page 685)
MILLER CHRISTIAN, 107 N. Water (See page 674)
 Miller Christian, 64 Martin
 Ricker W. G. 129 Mill
SCHAFFER J. C. 6 Hill (See page 684)
 Teal William, 126 Mill
TOMPKINS C. R. & CO., Mill corner Factory (See page 673)
TOWNSEND & WISEMAN, 1 Andrews (See page 665)
 Turner & Clement, 122 Mill
WIDDOWSON H. & A. foot Platt (See page 671)
WOODBURY, BOOTH & PRYOR, Mill n. Platt (See page 687)

Machinists' Tools.

GLEASON WM., Brown's race (See page 686)
MICHEL F. P. foot Platt (See page 685)

Magnetic Physicians.

BRYANT J. P. 150 Powers' buildings (See front colored page)

Malt.

Oothout S. N. & Son, Mt. Hope avenue
PARSONS E. B. 3 Smith's block (See page 561)

Mantles (Slate).

HEBARD HENRY S. 122 S. St. Paul (See front colored page)

Manufacturing Co's.

See Stock Companies.

Marble Mantles.

NELLS & KERN, 166 State (See page 646)
HEBARD HENRY S. 122 S. St. Paul (See front colored page)
 Riley A. A. 123 West Main

Marble Workers.

Allyn Cyrus, 33½ S. St. Paul
 Campin James, Mt. Hope avenue
HEBARD HENRY S. 122 South St. Paul (See front colored page)
NELLS & KERN, 166 State (See page 646)
STOCK NICHOLAS, Lake av. n. city line (See page 559)

Markets.

Altheimer S. 49 Clinton pl. c. North av.
 Andrews Thomas, 92 Plymouth avenue
 Austin J. G. 191 North
 Badhorn Joseph, Jay corner Childs
BAKER BROS. 258 State (See page 557)
 Bantel Joseph, 126 Lake avenue
 Bauerschmidt & Fromm, 34 Front
 Boothroyd Rowland, 33 North av.
 Bowman & Wick, 90 Plymouth av.
 Brown Adam, 42 Front
 Brown George, 6 Asylum
 Burgelin John, 51 North av.
DAGGS W. K. 329 State (See page 557)
 Davis C. G. 126 East avenue
 Doell John, 115 Mt. Hope avenue
 Doell John H. 144 Brown
EAST HENRY, 24 Front c. Exchange place (See page 558)
 Eisemann Bros. 134 St. Joseph
 Erdle Martin, 100 South avenue
 Faatz C. L. 201 Monroe avenue
 Fahy P. 26 Mumford
 Fischer John, 115 Lyell
 Fitzgerald M. 100 North St. Paul
 Grainger James K. 89 South St. Paul
 Haag Bernard, 232 E. Main
 Hahn J. jr. 56 South St. Paul
 Hamerick Joseph, 158 State
 Hampton & McCall, 348 State
 Hartell George, 46 Romeyn
 Hedditch Henry, 293 State
 Herman Henry, 140 East Main
 Herzberger Conrad, 226 East Main
 Herzberger George, 59 S. Clinton
 Hitzel Philip H., Jay cor. Oak
 Hoberker & Gesell, 104 West avenue
 Huber Jacob, South av. cor. Mt. Hope
 Ihrig Adam, 106 Chatham c. Kelly
 Ihrig George, 68 Hudson
 Ihrig John, 42 North Clinton
 Johnson J., Reynolds corner Cady
 Junker Wm. G. 220 West Main
 Killip James, 224 State
 Langknecht Herman, 243 N. Clinton
 Langknecht Jacob, 213 N. Clinton
 Langknecht Michael, 297 N. Clinton

HENRY C. WISNER,

DECORATED CHINA, SILVER SETS,
 No. 33 STATE STREET.

Lettau G. 30 Hanover
 Mauder Fred'k J., Galusha c. Oakman
 Maurer Chas. H. 130 Hudson
 McCLUSKEY JOHN, 130 W. Main
 (See page 553)
 Meyerhoff G., Spencer c. Saratoga av.
 MÖGRIDGE J. 25 Plymouth av. (See
 page 575)
 Morhardt Fred. 196 N. Clinton
 Morris Andrew L. 47 Front
 Murr Fred. 99 N. Clinton
 Nagle John, 52 South avenue
 Nersinger Lawrence, 182 N. St. Paul
 O'Kane Bros. 78 Bartlett
 Ottman J. 30 Front
 Pallett Wm. 3 Hunter
 Paul C. 70 Jay
 PEART & BOORMAN, 64 West av.
 (See page 554)
 Pfarrer George, 139 Lyell
 Pfeffer & Zimmer, 122 W. Main
 Piehler Sebastian, 162 Wilder
 Reichenberger Wm. V. 80 W. Maple
 Reinhardt & Koehler, North av. cor.
 Caspar
 Rommel C. & E. jr. 18 Bond
 Rothaug William, 135½ Jay
 Saile Joseph, 114 East Main
 Saile Peter, 149 East Main
 Schaefer William, 128 Scio
 Schake J. & A. 94 East avenue
 Schleyer Joseph. 136 East Main
 SCHLEYER PETER, 77 East av.
 (See page 556)
 Schmidt J. M. 101 Scio
 Schroth H. & C., Reynolds c. Adams
 Schroth Jacob jr. 106 St. Joseph
 Smith Michael, 141 West Maple
 Stevens S. W. 134 Plymouth avenue
 Stevenson F. J. 11½ Spring
 Stober Adam, 72 North St. Paul
 Stoecker Charles, 61 Frances
 Strassner H. 38 Orange
 Stroh Catharine Mrs., Herman corner
 Thomas
 Talbot Earl A. 34 Kent
 TEALL ABRAHAM, 79 Caledonia av.
 (See page 555)
 Theim Henry, 132 N. St. Paul
 Thiesson P. 3 Hudson
 Tice & Barnard, 26 Allen
 Tschetter Henry, 116 Pinnacle av.
 Vogel Adam, 163 West Main
 Walbrun J. 86 W. Maple
 Wallace Samuel, 39 Orchard
 WAYTE WM. E. 104 West Main (See
 page 554)
 West Charles, 61 Lyell
 Wheeler Louis, 106 North avenue
 Wiesler Conrad, 48 North avenue
 Wilson Edward C. 42 Lake avenue
 Wittman Jacob, 286 Brown
 Zegewitz & Fischer, 132 East Main
 Zimmer Adam, 39 Monroe avenue
 Zimmer George, 119 North Clinton
 Zimmer H. H. 152 North avenue
 Zimmer William, 13 Frances
 Zimmermann John, 54 N. Clinton

Masons.

See also Contractors.

Allmeroth Henry, Henrietta avenue
 Andrews Nicholas, 28 Hawkins
 Babcock B. 1 Chestnut park
 Bieck P. 264 North Clinton
 BLOCK PHILIP, 111 South avenue
 (See page 641)
 Burke J. J. 62 Kirk
 Carroll William, 112 North St. Paul
 Christ J. C. 50 Nassau
 Copeland William E. 81 Court
 DE JONGE & MARSIELJE, 34 Bu-
 chan park (See page 640)
 Dowling Patrick J. 119 N. St. Paul
 Fichtemaier G. 311 North Clinton
 FRIEDRICH A. 27 Baden (See p. 633)
 Garrison Minard, 79 Pinnacle avenue
 Gilbert Lewis C. 9 Alexander
 Gorsline Wm. H. 51 Powers' bldgs.
 Heberger J. & V. 284 N. Clinton
 Hennekey A. 5 Huntington n. Hudson
 HENRICUS MICHAEL & SON, 2
 Hanover (See page 590)
 Hutter Frederick, 69 Hudson
 Inman I. L. 73 Hunter
 Lauer John C. jr. 21 Wilson
 Lauer J. M. 82 Court
 Lavis & Yates, 7 Julia
 MAUDER JOHN, 271 N. Clinton (See
 page 640)
 MAXON GEO. L. 10 Tremont place
 (See page 634)
 Maxson Benjamin, McCracken c. First
 Maxson W. J. 10 Eagle
 McELHINNY J. W. 47 Chestnut (See
 page 633)
 McGraw Peter, 103 Mt. Hope avenue
 O'Connor J. 59 Hamilton place
 PAPPERT AUGUST, 110 Pinnacle
 avenue (See page 641)
 Parry William F. 4 Prospect
 Payne Charles G. 25 Frances
 Quine William, 52 Chatham
 Raulback Joseph, 6 Leopold
 Schanck W. W. 163 East Main
 Schauman Fred. jr. 14 Buchan park
 STALLMAN BROS. 78 Cady (See
 page 633)
 Stein C. 22 Morris
 Stowell F. B. 106 Fulton avenue
 Strauchen John, North avenue
 Strauchen J. R. & F., Bay n. North av.
 SUMMERHAYS WM. 56 Alexander
 (See page 587)
 THOMPSON GEO. H., & CO. E. Main
 cor. North av. (See page 636)
 TURVER C. H. 39 S. Ford (See p. 532)
 Van Doorn J. 44 Tappan
 Watson E. 37 Court
 WHALEN D. 16 Stone (See page 654)
 Woods Thos. 44 Asylum
 Ziegler Louis, Hunter near Frances

Masons' Materials.

COPELAND D. Jr. 90 South St. Paul
 (See page 658)
 WHALEN D. 16 Stone (See page 654)

Masquerade Dresses.

KUHLMAN JOHN, 3 Oregon (See page 544)

Match Makers.

Dengler M. 366 Brown

Mathematical and Philosophical Instruments.

BAUSCH & DRANSFIELD, 20 Arcade (See page 515)

Mats.

Schofield H. C. 110 State

Mattresses.

HUNN, SPENCER & CO. 74 State (See page 612)

Mechanics' Tools.

BARTON D. R. TOOL CO., Mill c. Furnace (See page 676)

ERNST L. 3 West Main (See page 630)

FLINT J. 153 State (See page 673)

SEIFRIED F. & CO. 13 West Main (See page 630)

STOTT GEO. F. (files), River (See p. 581)

Medicines.

See Patent Medicines.

Mercantile Agencies.

BRADSTREET J. M. & SON CO. 28 and 30 Arcade (See front cover)

DUN R. G. & CO. 15 Exchange (See page 692)

Mesmerist.

REYNOLDS JOHN, 40½ Fitzhugh (See page 582)

Midwives.

Craner Amelia E., Evergreen park

Fritz Catharina F. 14 Cayuga place

Goetz Dorothea Mrs. 74 Kelly

Hess Minna Mrs, 34 Vienna

Hoeret Julia Mrs. 85 North avenue

Koehler Mina, 166 North Clinton

Leimester M. Mrs. 91 Smith

Marburger Margaret Mrs. 21 Stillson

Metzger Clara, 174 North Clinton

Scheib Wilhelmina Mrs. 147 Jay

Schneider Catharine Mrs. 57 Nassau

Schutter Lisette, 50 St Joseph

Tauber Catharine, 1 Hanover

Walther C. Mrs. 5 Langham

Weyburn L. D. Mrs. 14 First

Milk.

JOSLIN T. M. 156 State (See page 571)

Millinery Goods.

WHOLESALE.

FAHY J. & CO. 64 State (See page 545)

Lord H. 108 State

MOCK A. 52 State (See page 545)

SHATZ, LOWENTHAL & LEITER, 40 State (See page 545)

SWEETING J. B. & BRO. 84 State (See under Calendar)

RETAIL.

Backus H. H. Miss, 40 State

Blessor C. Miss, 129 East Main

Boyce M. A. Mrs. 113 Monroe avenue

Brown M. A. Mrs. 87 North Clinton

Burlingame M. E. 83 East Main

Cherry Mary Mrs. 162 West Main

Crawford M. Miss, 115½ East Main

Dawson Sarah A. Mrs. 5 Sibley's blk.

Doane W. A. & Co. 45 East Main

Edmonds J. M. 79 East Main

Elliott Mary A. 33 Scio

Farrell M. Mrs. 17 South avenue

Fechenbach Sophia, 51 Monroe av.

Friend Frances M. 151 North Clinton

Gardner A. M. 130 State

HANNA J. B. 44 State (See page 546)

Hanvey M. J., Saxton corner Lime

Harper S. A. 125 East Main

Hastings L. H. Mrs. 2 Elwood block

Jones Sarah Miss, 298 State

Kuenemann Mary L. 198 North Clinton

Laich L. Mrs. 135 St. Joseph

Lipe Phebe E. 34 Franklin

Loizeau V. Mrs, 25 Brown

Mann K. S. 222 State

McGrayan Katie, 144 State

Meyer Louisa, 280 North Clinton

MOCK A. 52 State (See page 545)

Oertel Bertha Mrs. 77 North avenue

PENNY E. A. 111 E. Main (See p. 547)

Phelan M. C. 76 State

Pincow H. Mrs. 107 East Main

Purdy S. M. Mrs. 43 South avenue

Rust Emma Mrs. 17 Hanover

Steinle Maria, 137 East Main

SWEETING J. B. & BRO. 84 State

(See under Calendar)

Taft & Ferguson, 58 State

Vorhees J. Mrs. 81 East Main

Wagner Caroline Mrs. 70 Hudson

Weber Josie M. 40 South St. Paul

Whitelock William, 99 East Main

Wilson Elizabeth Mrs. 180 East Main

Wolz Mary T. Miss, 26 Campbell

Mill Machinery.

ERDLÉ & OLIVER, Mill cor. Brown (See page 586)

MICHEL F. P., Mill opposite Platt (See page 685)

Mills.

See Flour Mills.

Millwrights.

COWLES JOSEPH, 127 Mill corner Platt (See page 676)

Farquharson D. S., N. St. Paul middle falls

FINZER & ZARGES, 13 S. Water, (See page 676)

Redfern Thomas, 110 Mill

Mineral Water.

SCHNARR H. H. & BRO. 114 North Clinton (See page 566)
Tracy J. 23 Hill

Model Makers.

See also *Pattern Makers.*

LESTER & GILLARD, Mill opposite Factory (See page 675)
WALDER AMOS, 130 Mill (See p. 675)

Monuments.

HEBARD HENRY S. 122 South St. Paul (See front colored page)
NELLS & KERN, 166 State (See p. 646)
PITKIN PETER, 22 West av. (See page 660)
POWERS JAS. 97 N. St. Paul (See page 646)
STOCK NICHOLAS, Lake av. (See page 559)

Morocco Manufs.

Armfield Fred G. 321 N. St. Paul
CARING, WEICHER & CO. 87 N. Water (See page 665)
Eddy S. S. & Co. 25 North Water

Mould Manufs.

SCHAFFER J. C. 6 Hill (See page 684)

Moulding Machine Manufacturer.

LEE H. A. Worcester, Mass. (See page 586)

Moulding Manufs.

BANTLEON D. 123 North Water (See page 649)
EMPIRE MOULDING WORKS, 39 Gorham (See page 609)
GALLIGER M. 3 Aqueduct (See p. 576)
HORCHELER & MILES, Aqueduct (See page 639)
O'CONNOR & DEVEREAUX, foot North Water (See page 639)
PAYNE JAMES (frame), River n. N. St. Paul (See page 624)
SMITH J. A. 13 Warehouse (See p. 651)
Summers & Turpin, 43 North Water
TURPIN FRED. 110 Front (See p. 583)
VAN HOESEN S. C. 15 Warehouse (See page 579)

Mourning Goods.

MANN A. S. & CO. 17 State (See top end of book)

Music.

BANDS.

FIFTY-FOURTH REGIMENT BAND, J. Sauer, leader, Aqueduct (See p. 524)
Hebing's Cornet Band, Anthony Hebing, leader, 74 East Main
Lang's Band, Valentine Lang, leader, 259 North Clinton

Newman's Band, Charles Newman, leader, 66 Scio
New York Light Artillery Band, W. Heinrich, leader, 58 S. St. Paul
Schaich's Orchestra, L. C. Schaich, leader, 181 North Clinton

Music Publishers.

Ardrey J. G. 96½ East Main
Schaich L. C. & Son, 181 N. Clinton

Music Stores.

CRAIGHEAD JOHN, 109 East Main (See page 525)
GIBBONS & STONE, 86 State (See page 525)
Mackie H. S. 82 State
MARTIN J. W. & BRO. 59 State (See page 524)
Shaw J. P. 16 East Main

Music Teachers.

See *Teachers.*

Mustard Manufs.

VAN DE CARR R. D. 31 Exchange (See page 597)
VAN ZANDT B. B. 112 State (See opp. page 550)

News Depots.

Case Bros. 13 Monroe avenue
Clark I. S. 45 North Clinton
DARROW ERASTUS, 67 East Main (See page 518)
HEWITT FRANK L. 44 South av. (See page 570)
Klinger J. M. 261½ North Clinton
Kyle C. W. Centre cor. Mill
Meagher M. A. 70 Jay
MERK W. 5 North Clinton (See p. 514)
Player Thos. 317 State.
Randolph Mary E. 130 North St. Paul
Renfrew Robert, 88 West avenue
Stewart C. P. Mrs. 122 Plymouth av.

Newspapers.

AMERICAN RURAL HOME, Rural Home Publishing Co. 31 Arcade weekly, \$2.00 per annum (See *Blocks, Buildings, &c.*)
Earnest Christian, Rev. B. T. Roberts, 87 State, monthly, \$1.25 per annum
Hospital Review, 28 Spring, monthly, 50 cts. per annum
ROCHESTER BEOBACHTER (German), Adolph Nolte, 23 W. Main, daily, \$7.80; weekly, \$2.50 (See page 521)
ROCHESTER DEMOCRAT AND CHRONICLE, Rochester Printing Co. 3 West Main, daily, \$9.00; semi-weekly, \$3; weekly, \$1.50 (See page 531)
ROCHESTER EXPRESS, Evening Express Printing Co. 23 W. Main, daily, \$9; tri-weekly, \$4; weekly, \$1.50 (See opp. page 528)

A. R. PRITCHARD & LIKLY,

SOLID RED CEDAR TRUNKS,
No. 78 STATE STREET.

Rochester Mechanic, C. R. Tompkins & Co. Mill cor. Factory, monthly
ROCHESTER REPUBLICAN, Union and Advertiser Co. 82 West Main, weekly, \$1.50 per annum (See page 530)
 Rochester Times, Daniels & Phillips, 18 West Main, weekly, \$2.50 per annum
ROCHESTER UNION AND ADVERTISER, Union and Advertiser Co. 82 West Main, daily, \$9.00; semi-weekly, \$3.00 (See page 530)
 Rochester Volksblatt (*German*), Louis W. Brandt, 18 N. St. Paul, daily, \$6.00; weekly, \$2.20
 Von Nah Und Fern (*German*), 149 North Water, G. Feuchtinger, jr. weekly, \$1.00

Nickel Platers.

ROCHESTER PLATING WORKS (gold and silver), 122 Mill (See page 670)
SARGENT & GREENLEAF, Stone corner Court (See front colored page)

Notaries Public.

See also Notaries in Contents.

MAURER GEORGE C. 78 E. Main (See page 595)
ROBERTS G. HENRY, 6 Elwood blk. (See inside front cover)

Nursery Stock Dealers.

Glen Bros., East avenue n. Goodman
 Manchester Geo. W. 78 Monroe avenue
ST. ANGE J. DE (*French importer*), 67 Fulton avenue (See page 526)
 Williams Ezra, 52 North Water

Nurserymen.

See also Florists; also Seedsmen.

BECKWITH H. & J. K. at Brighton (See page 527)
CHARLTON JOHN, University av. (See page 527)
CHASE BROS. 1 East park (See page 526)
 Ellwanger & Barry, 134 Mt. Hope av.
 Fish G. T. 35 Arcade
FROST & CO., Frost avenue corner Olean (See front cover)
GOULD BROS., East avenue near Brighton (See back cover)
HOOKER H. B. & CO. 255 North St. Paul (See page 526)
HOOKER H. E. & BRO., East av. near Goodman (See front cover)
 Jones & Palmer, Locust n. Fulton av.
KELLER J. B., Mt. Hope avenue (See page 527)
KING WM. & SON, 123 Mt. Hope av. corner Sanford (See page 526)
LITTLE W. S., East avenue n. Culver (See back cover)
McKINSTER G. G., Webster road n. Culver (See page 592)

Moulson George & Son, North Union
NORRIS J. B. & SON, at Brighton (See page 559)
PARCE J. J. Fairport (See page 579)
SAINT ANGE J. DE (*French*), 67 Fulton avenue (See page 526)
 Salter Josiah, University av. n. Culver
WARING & SCOTT, E. Main corner Goodman (See page 649)
 Wentz J., East Main cor. N. Union
 Wright Thomas & Co. 167 S. St. Paul
YALE T. B. & CO., East avenue (See page 559)

Nurserymen's Plates.

THOMPSON J. W. & CO. 142 East Main (See page 527)

Nurses.

Andrew Mary, 6 Montrose
 Brady Catharine, East av. cor. Prince
 Brothers Rachel A. 11 Vincent place
 Brown A. C. Miss, 19 Ambrose
 Brown Julia A. Mrs. 5 Vienna
 Bundy Jennie E. 58 Monroe avenue
 Callery M. Miss. 7 Stone
 Chaplin N. H. 44 Park avenue
 Clark Lucina, 1 Tracy park
 Clark S. 9 South avenue
 Colegrove Louise, 49 Platt
 Connor Matilda, 10 Smith
 DeForrest Lydia A. Mrs., East Main corner Lancaster
 Doty Mary E. 81 Scio
 Downing Josephine E., E. Maple cor. Frances
 Edmonds Catharine, 61 East avenue
 Emery Mary, 58 Allen
 Farrel Mary, 19 Arnold park
 Hammond C. Mrs. 5 Jones
 Hewes Jenny M. 75 Court
 Jackson Isabella, 71 Adams
 Jones Rachael J. Mrs. 62 Caledonia av.
 Mahaney Margaret H. 37 Litchfield
 McKale Jane, 44 South Union
 Meek Sarah, 89 South St. Paul
 Morris Elizabeth, 4 Foehner
 Morrison Flora A. 8 Vine
 O'Donohue B. Mrs. 22 Andrews
 Oliver Mary, 17 Montrose
 O'Reilly Celia Mrs. 33 Orange
 Osborn E. J. Mrs. 55 Caledonia av.
 Parkinson Jane E. 111 Monroe av.
 Pearce Josephine, 4 Phelps avenue
 Perkins Mary A. Mrs. 19 Jones av.
 Pike Almira, 36 Charlotte
 Piper John, 8 Vine
 Price Anner, 47 Chestnut
 Quirk Annie, 126 Alexander
 Smith Margaret, 26 Hudson
 Stumps Anthony Mrs. 128 North av.
 Teit Isabella, 27 Scio
 Tumulty Lawrence, 250 Plymouth av.
 Wait Jennie Mrs. 9 Jay
 Weir Maria, 24 Gregory
 Wellman Emily Mrs. 136 Adams
 Wier Rebecca, 60 Concord avenue
 Wilkin Libbie R. Mrs. 42½ Lyell

Williams Fannie E., East avenue opp.
Bowen
Woodward Mary E. 20 Park avenue

Ochre Manuf.

ROCHESTER OCHRE MFG. CO. 91
North Water *See page 683*

Oculists.

FOWLER WM. P. 27 Fitzhugh *(See page 513)*

Oil Cloths.

ROGERS & CONVERSE, 14 Exchange
(See page 597)

Oils.

EVEREST C. M. *(refined petroleum)*,
128 Powers' bldgs. *(See page 678)*
HUNTINGTON M. & E. 36 E. Main
(See front colored page)
Katz Joseph, 5 Elm
VACUUM OIL CO. 128 Powers' bldgs.
(See page 681)
WILLIAMS & BASSETT, 85 Exchange
(See page 680)

Oils.

(Lubricating and Illuminating).

PEASE F. S. manufacturer of oil, 65
and 67 Main street, 82, 84 and 86
Washington street, Buffalo, N. Y.
(See page 584)

Opticians.

BAUSCH & DRANSFIELD, 20 Arcade
(See page 515)
Bausch & Lomb Optical Co. 179 N.
St. Paul
Hechinger L. 58 West Main

Oyster Dealers.

HEMINGWAY H. F. & CO. 123 State
(See page 575)
PALMER DWIGHT *(wholesale and retail)*,
76 Front *(See back colored page)*

Oyster Packers.

HEMINGWAY H. F. & CO. 123 State
(See page 575)

Package Deliverers.

STONE JOHN S. & SONS, 106 West
Main *(See page 604)*

Packing Boxes.

DISBROW IRA S. 3 Aqueduct *(See page 630)*
STEVENS J. B. & SON, foot Centre
(See page 535)

Paint Manuf. (Ochre)

ROCHESTER OCHRE MFG. CO. 91
North Water *(See page 683)*

Painters.

CARRIAGE.

Archer Ralph, 245 E. Main
Arend John, 148 Plymouth avenue
ARNOLD GEORGE, 109 State *(See page 644)*
Barnum Alfred, 31 Mumford
Berndt A. 19 Wadsworth
Burroughs P. C. 7 Ely
Crawn A. C. 194½ W. Main
HAHLE WM. H. 109 Pinnacle av.
(See page 604)
Morris J. B. 115 S. St. Paul
Parmelee W. F. 35 S. St. Paul
Powers & Cunningham, Mortimer cor.
North Water
RENAUD JOHN, 17½ North *(See page 603)*
Roberts J. S. 9 Division
Steen K. 6 Plymouth avenue
Wilson J. B. 16 Market

FRESCO.

BISHOP E. A. 12 Stone *(See page 644)*
HAYKEN & HENSEL, 88 Arcade
(See page 591)
LEMPERT LEON H. 9 Howell *(See page 591)*

HOUSE AND SIGN.

ARNOLD G. 109 State *(See page 644)*
Badger James G. 41 South av.
Banning Wm. A. & Bro. 14 Stone
Bennett J. J. 165 E. Main
BISHOP E. A. 12 Stone *(See page 644)*
Bohrer Conrad, 37 Campbell
Bond J. E. 112 E. Main
Bortle G. P. 50 West avenue
Boyles Frank, 6 East avenue
Brady John, 165 E. Main
Brumby Charles, 250 Plymouth av.
Carnes H. R. 5 Andrews
Day Wm. B. 5 Spring
Denny J. W. 46 Lyell
ERNISSE ABRAHAM & SON, 88
Powers' bldgs. *(See page 644)*
Faust George, 61 Smith
Glover Alanson D. 207 East Main
Gordon W. H. 10 Foechner
Gosnell James jr. 128 North
Harrison & McQuade, 2 S. Washington
Hawken A. N. 14 Stone
HAYKEN & HENSEL, 88 Arcade
(See page 591)
Jones J. 147½ E. Main
Kennedy M. H. 157 W. Main
Knapp M. T. 195 N. St. Paul
Luig Gustave, 30 Buchan park
Manley John P. 49 Nassau
McCormick T. 10½ S. St. Paul
MILLER E. T. 9 West Main *(See page 623)*
Murphy J. 47 East Main
Neer Wm. E. 16 Stone
Nicholson G. 51 Bolivar
Pierce Frank W. 146 E. Main
Rice E. J. 102½ East Main

Robins J. I. & Son, 10 Front
 Rohr John, 73 State
 Schake A. 56 Weld
 Scott H. L., Goodman n. Monroe av.
 Sike William, 163 East Main
 Stewart John L. 51 Front
 Turnbridge Bros. 40 West avenue
 Vanderwerf M. 5 South St. Paul
 VAN DOORN FRANK, 74 Arcade
 (See page 644)
 Whitehouse Wm. 125½ State
 Whittlesey & Weston, 134 Plymouth
 avenue
 Williams W. 14 Cliff

PORTRAIT AND LANDSCAPE.

Baker Isaac C. 13 Lake avenue
 Ballantine M. A. 195 Powers' bldgs.
 Collet Chas. 107 Arcade
 Duncan W. A. 173 Powers' bldgs.
 Forkel C. W. 174 Powers' bldgs.
 Gilbert G. S. 99 Arcade
 Hewitt Elnora, 42½ Lyell
 Kellogg Daniel J. 15 Selden
 Lester Wm. R. 192 Powers' bldgs.
 Norton H. B. 175 Powers' bldgs.
 Rosenberg H. L. C. 12 E. Main
 Smith R. B. 13 Hamilton place
 Stebbins E. L. 13 Hamilton place
 Taylor D. B. 155 W. Main
 Wagner D. 95 Arcade
 Wagner M. L. 95 Arcade
 Whipple Eleanor, 89 South Union
 Wilbur I. E. 106 Arcade
 Woodward Ida F. (*India ink*), 16 Kent

SIGN AND ORNAMENTAL.

ARNOLD GEORGE, 109 State (See
 page 644)
 BISHOP E. A. 12 Stone (See page 644)
 ERNISSE A. & SON, 88 Powers'
 bldgs. (See page 644)
 Etheridge O. H. 66 Arcade
 LINE E. 88 Arcade (See page 517)
 Millington S. A. 21 Smith's block
 VAN DOORN FRANK, 74 Arcade
 (See page 644)
 Waleson Gerard, East Main cor. East
 avenue

Paints, Oils, Glass, &c.

BARNARD J. C. 23 Front (See page
 625)
 Goodwin H. E. 202 State
 HUNTINGTON M. & E. 36 E. Main
 (See front colored page)
 Langdon E. M. & Son, 85 South av.
 Luitwieler J. G. 82 East Main
 Osgood & Clark, 4 Front
 SOUTHALL & COOK (*varnish*), 116
 Front (See page 611)
 WOODBURY, MORSE & CO. 5 West
 Main (See page 625)

Pamphlet Binders.

BENFORD & ANDREWS, 1 Aque-
 duct (See opp. page 513)

**Pamphlet Covering Ma-
 chines.**

CLAGUE, RANDALL & CO. 1 Aque-
 duct (See page 677)

Paper Bag Manufs.

CRAMER J. G. 25 West Main (See
 page 678)

Paper Box Makers.

See also Box Makers.

HUNT J. K. 91 North Water (See
 page 645)

LETTINGTON H. 25 Exchange place
 cor. Front (See page 645)

Paper Hangers.

MILLER E. T. 9 West Main (See page
 623)

Paper Hangings.

MILLER E. T. 9 W. Main (See page
 623)

Weldon G. & W. 52 East Main
 Williams & Managan, 132 E. Main
 Zorn S. A. 15 Front

Paper Manufs.

ROCHESTER PAPER CO. at lower
 falls, A. M. Hastings, president
 (See page 521)

Paper Rulers.

BENFORD & ANDREWS, 1 Aque-
 duct (See opp. page 513)

Paper Stock.

HEY LEVI, 215 State (See page 670)
 LANEY JAMES, 144 E. Main (See
 page 670)
 STRATTON G. L. & CO. 61 State
 (See page 529)

Paper Warehouses.

ALLING & CORY, 10 and 12 Exchange
 (See page 528)
 Hawley, Meyers & Co. 55 State
 LANEY JAMES, 144 East Main (See
 page 670)
 STRATTON G. L. & CO. 61 State
 (See page 529)

Patent Agents.

See Agents, Patent.

Patent Medicines.

AMAN H. 139 E. Main (See page 569)
 Barnes & Co. 14 E. Main
 BRYANT J. P. 150 Powers' bldgs.
 (See front colored page)
 DAVIS E. H. 81 State (See front cover)
 Gardner N. H. 149 State
 HAASS G. H. 38 East Main (See back
 cover)
 HAMBLETON A. 111 Plymouth av.
 (See page 569)

HOP BITTERS CO. 50 Mill (See page 596)
 IRISH J. P. 255 State (See page 570)
 PAINE C. F. & CO. 20 West Main (See front cover)
 REESE & HASKIN, 66 West Main (See front cover)
 Rowe Charles E. 12 Pearl
 Ruff Conrad, 110 St. Joseph
 STEVENS C. E. 62 West av. (See page 570)
 TAFT BROS. 146 West Main (See page 570)

Pattern Makers.

Graham George H., Clinton Mills
 LESTER & GILLARD, Mill n. Factory (See page 675)
 Manley William (shoe), 111½ N. Water
 SHORER & TAILLIE, 145 N. Water (See page 682)
 Smith D. W. 187 West Main
 WALDER AMOS, 130 Mill (See page 675)

Patterns (Dress).

Craven Sisters, 49 State
 DIBBLE S. W. & DUTTON, 20 E. Main (See page 538)
 HENDERSON JAS. MRS. (Domestic), 52 State (See page 548)
 JONES & SUGRU (Butterick's), 43 State (See page 549)
 Vincent John P. 10 South Clinton

Pawn Brokers.

See also Brokers.

WHEELER WESLEY, 6 Masonic Hall bldg. (See page 508)

Peddlers' Goods.

LANEY JAS. 144 East Main (See page 670)

Perfumery Manufs.

Angell Charles H. 50 Mill
 Lalor & Skinner, 205 Plymouth av.
 NEWMAN J., at Fairport (See page 585)
 SPIEHLER A. 24 E. Main (See page 668)
 WOODWORTH C. B. & SON, 113 West Main (See page 668)
 WRIGHT ALFRED, 149 State (See page 593)

Periodicals.

See News Depots.

Petroleum (Refined).

EVEREST C. M. 128 Powers' bldgs. (See page 678)
 WILLIAMS & BASSETT, 85 Exchange (See page 680)

Photo Engravers.

RAMSDALL GEO. D. 142 Powers' bldgs. (See page 520)

Photograph Colorers.

Dryer Charles A. 171 Powers' bldgs.
 LE CLEAR A. A. 80 State (See page 522)
 Lester Wm. R. 192 Powers' bldgs.
 Maitland Percy, 31 Chestnut
 Smith E. J. 97 Powers' bldgs.
 TAYLOR JOHN W. 83 E. Main (See page 542)

Photographers.

Bacon F. W. 55 East Main
 CROSSMAN B. P. 120 State (See page 522)
 DUMBLE A. E. & CO. 44 State (See page 522)
 Dunshee C. E. 14 State
 Ford F. S. 45 East Main
 GODFREY G. W. & CO. 81 East Main (See page 522)
 Gregg Sherman, 78 State
 Hale B. F. 75 East Main
 Hedley L. C. 96 State
 Kent J. H. 58 State
 LECLEAR A. A. 80 State (See page 522)
 Lehnkering A. C. L. 70 State
 Oakley N. 91 East Main
 Roberts John, 106 State
 Sherman L. 18 West Main
 TAYLOR JOHN W. 83 East Main (See page 542)
 Veeder E. C. 45 East Main

Photographic Stock.

BRADLEY P. B. 118 Front (See page 523)
 Hovey D. 32 North Water
 Marks Henry D. 12 State
 WOODWARD C. W. 126 State (See page 532)

Physicians.

Andrews G. C., Market c. Mill
 Babbage E. F. 136 State
 Bardeen A. Mrs. (botanic), Reynolds c. Clifton
 Bardeen F. (eclectic), Reynolds corner Clifton
 Bartholick G. A. 12 Glasgow
 Bennett A. M. 49 North
 Birmingham J. J. 183 Powers' bldgs.
 Brouwer Cornelius T. 12 Elm
 BRYANT J. P. 150 Powers' bldgs. (See front colored page)
 Butterfield David, 97 Broadway
 Campbell John A. 10 S. Clinton
 Carpenter Isaac, 22 Favor
 Chaffee D. J. 5 South Clinton
 Clark Samuel M. 219 North Clinton
 CURTIS JOHN L. 183 Powers' bldgs. (See page 592)
 Dake J. W. 25 Hamilton place
 Dake W. H. 62 North avenue
 Davis Daniel (allo.), 110 State
 DeNeve J. C. A. 54 St. Joseph
 Dutton J. C. 185 Powers' bldgs.

Eves William (*allo.*), 9 Franklin
 Faulkner Lewis K. 28 North avenue
 FOWLER W.M.P. (*oculist*), 27 Fitzhugh
 (*See page 513*)
 Gibbs W. H. Mrs. 120 State
 Gilbert J. P. 120 State
 Gillett M. H. 321 State
 Greene W. D., City Hospital
 Harrington J. C. 13 Smith block
 Hartman W. A. 183 East Main
 Hartupee Andrew W. 92 Fulton av.
 Havill T. 55 Vienna
 Henion John B. 165 West avenue
 HIBBARD S. A. 134 East avenue n.
 Alexander (*See page 569*)
 Knowles Isaac C. 12 South St. Paul
 Lighthill Carl B. 14 Leopold
 Lyon Edward L. 2 Joslyn park
 Manning J. 196 Brown
 Maxfield Sarah M. 72 Mt. Hope avenue
 McCarn Sarah J. 38 Lyell
 Monroe S. J. Mrs. 62 Asylum
 Newell Jared M. 120 Alexander
 Pardee E. B. 49 North avenue
 Parkhurst Mary, 24 Sophia
 Post Julius A. 85 East Main
 Prevost Isidore E. 15 Gibbs
 REYNOLDS JOHN (*magnetic*), 40½
 Fitzhugh (*See page 582*)
 Reynolds John A. 10 Sophia
 Rice M. Louise, 2 Clarissa
 Robinson Evans, 6 Concord avenue
 Rose H. G. C. 96 State
 Russell Samuel, 125 Cady
 Seely J. E. 117 Plymouth avenue
 Smith R. J. 45 Fitzhugh
 Smyles John, 62 East Main
 Sprague O. C. 152 Powers' buildings
 Stilwell F. W. (*homoe.*), 90 North av.
 Swan Thomas, 123 Powers' buildings
 Taft G. T. 8 Oak
 Taylor F. L. 96 West avenue
 Wark David, 26 Frank
 Watson C. V. 180 Powers' buildings
 Weyburn L. D. 14 First
 Widemann John M. 17 Nassau
 Wilder L. De V. 119 West Main
 Wohlgemuth William, Glenwood av.
 near Third
 Wood E. L. 32 South St. Paul
 Wooden C. D. 347 State

*Members of the Monroe County Medical Society.
 List prepared by J. W. Whitbeck, Secretary of
 the Society.*

Archer Wm. W. 32 East avenue
 Arink G. 35 Andrews
 Backus Azel, 38 Front
 Beach G. L. 48 South avenue
 Bowen J. C. 20 Savannah
 Bradley Hugh, 21 Oak
 Brennan E. J. 1 South
 Braithwaite Sarah, 26 Elm
 Armstrong E. W. 14 N. Washington
 Beahan James, 139 West avenue
 Benford G. T. 24½ East Main
 Briggs Wm. H. 75 East Main
 Buckley Charles jr. 62 East Main

Cameron Charles Mc D. 50 Lake av.
 Carroll George G. 8 Sophia
 Cary Charles, City Hospital
 Casey J. W. 15 Sophia
 Clarke Elias A. 128 State
 Collins T. B. 74 East Main
 Cox H. M. 318 State
 Dann A. 45 East Main
 Davison S. W. 138 East Main
 Dean H. W. 33 Fitzhugh
 Dolley Sarah, R. A. 30 East avenue
 Ely W. S. 67 Fitzhugh
 Ely W. W. 67 Fitzhugh
 Forbes Charles, 18 Tremont
 Gallery F. B. 256 State
 Gilkeson B. F. 57 State
 Hamilton Franc F. 1 Henion place
 Hovey B. L. 35 Fitzhugh
 Howard E. H., Monroe Co. Poor House
 Jones Jonas, 116 West avenue
 Kempe J. J. 11 Grove
 Kuichling L. 76 North Clinton
 Lakeman W. H. 3 Smith
 Lord Matthias L., Insane Asylum
 Langworthy H. H. 79 State
 Little David, 82 Plymouth avenue
 Mallory M. L. 12 Fitzhugh
 Mandeville A. & F. A. 96½ East Main
 McKelvey C. E. 93½ State
 Monroe J. S. 27 Sibley's block
 Moore E. M. jr. 63 Fitzhugh
 Montgomery H. F. 7 Smith's block
 Moore E. M. 63 Fitzhugh
 Nüsslin Fried, 2 Mortimer
 O'Hare Thomas H. 125½ State
 Padiera G., Franklin cor. N. St. Paul
 Pierce S. A. 24 East Main
 Preston B. I. 16 Chestnut
 Preston E. S. 16 Chestnut
 Reichenbach J. F. 24 King
 Rider C. E. 60 Fitzhugh
 Rockwell A. S. 2 Washington Hall blk.
 Roe J. O. 8 Washington Hall
 Schmitt Julius, 138 East Main
 Searing Anna H. 30 East avenue
 Secord Levi, 96½ E. Main
 Sherman H. B. 135 East Main
 Shipman D. M. 29 Fitzhugh
 Speare M. R. 100 North
 Stafford John, 86 South avenue
 Starr C. S. 18 Fitzhugh
 Stoddard E. V. 33 Fitzhugh
 Swinburn George, 12 Jay
 Wallace G. A. 18 North Clinton
 Webb William H. 24 Rowley
 Weigel L. A. 57 North Clinton
 Whitbeck J. F. 18 Gibbs
 Whitbeck J. W. 18 Gibbs
 Whitcomb E. E. 128 State
 Wilbor Charles W., North Clinton cor.
 Gorham

Brockport.

Braman A. N.
 Carpenter D.
 Hill J. H.
 Mann W. B.
 Thatcher Ralph

Charlotte.

Dean O. A.
Jones A. M.

Chili.

Gandy L. T.
Starkey D.

Churchville.

Craig J. W.

Clarkson.

Morse H. A.

Clifton.

Bailey W. C.

East Rush.

Hammond C. H.

Fairport.

Durand T. B. V.
Fuller W. S.

Greece.

Carpenter A. B.
Carpenter A. M.
Hillman L. L. F.

Mendon.

Hanna G. W.

North Parma.

Holman S. A.

Penfield.

Preston C. E.

Pittsford.

Carpenter P. D.
Reynolds R. C.

Scottsville.

Denman J. I.
Edson F.
Howe W. J.
Lacy W. G.

Spencerport.

Slayton W. C.
Udell P. G.

West Mendon.

Miner H. B.

Members of the Monroe County Homoeopathic Society. List prepared by Geo. F. Hurd, Secretary of the Society.

Adams R. A. 31 North Fitzhugh
Baker C. W. 87 Plymouth avenue
Bates F. DeW. 27 Fitzhugh
Biegler J. A. 16 North St. Paul
Carr A. B. 32 North Clinton
Dake Jabez W. 25 Hamilton place
Fowler W. P. 27 Fitzhugh
Hurd E. H. & G. F. 62 Sophia
Metcalf J. W. 27 Alexander
Oaks J. F. 86 North Clinton
Peer Geo. W. 23 North Clinton
Pinkham C. E. 22 North St. Paul
Sumner Charles, 14 South Clinton
White T. C. 21 South Clinton

Brayton S. N., Honeoye Falls
Reynolds L. H., Brockport
Wheeler J. P., Brighton

Pianos and Organs.

See also Music Stores.

Binder Julius, 3 Mumford
CRAIGHEAD J. 109 East Main (*See page 525*)
GIBBONS & STONE, 86 State (*See page 525*)
MARTIN J. W. & BRO. 59 State (*See page 524*)

Piano Manufs.

GIBBONS & STONE, 86 State (*See page 525*)

Piano Movers.

Patterson R. jr. 54 Spring

Piano Stools.

ARCHER GEO. W. 7 North Water (*See page 621*)

Piano Tuners.

Binder Julius jr. 3 Mumford
Davis Henry, 104 Scio
Davis Wm. H. 42 Buchan park
Edmonds M. D. 59 State
Pistorius F. 82 State
Senke Frederick, 86 State

Picture Frame Mouldings.

EMPIRE MOULDING WORKS, 39 Gorham (*See page 609*)
PAYNE JAS. River (*See page 624*)
TURPIN FRED. 110 Front (*See p. 583*)

Picture Frames.

BRADLEY P. B. 118 Front (*See page 523*)
Dow F. A. 250 State
GILLIS J. W. 8 Allen (*See page 524*)
JONES ALBERT J. 22 East Main (*See page 648*)
LOCKHART JAMES, 121 State (*See page 525*)
RUNDEL H. P. 57 West Main (*See page 523*)
SANDERSON I. H. 24 Exchange (*See page 523*)
Shelter Henry, 57 State
WOODWARD C. W. 126 State (*See page 532*)

Picture Stores.

Allen C. & T. W. 105 State
GILLIS J. W. 8 Allen (*See page 524*)
Hoenner L. 71 Allen
JONES ALBERT J. 22 East Main (*See page 648*)
RUNDEL H. P. 57 West Main (*See page 523*)
SANDERSON I. H. 24 Exchange (*See page 523*)
WOODWARD C. W. 126 State (*See page 532*)

Picture Mounters.

GIVENS THOMAS, 114 Front (See page 518)

Pipe Manufs. (Water).

THOMAS E. L. 93 South St. Paul (See page 588)

Plane Makers.

Evans E. & J. 30 North Water

Planing Machines.

CONNELL & DENGLER, Mill cor. Furnace (See opp. page 551)

Planing Mills.

See also *Turning, Sawing, &c.*

Bell J. D. & Son, Court st. bridge
BENNETT & BARRY, 140 Lake av. (See page 639)

BRONSON AMON, Exchange near Troup (See page 652)

Butler & Calkins, Warehouse n. Platt
CAMERON & CHACE, 19 Warehouse (See page 653)

CHAMBERLAIN & MORDOFF, State cor. Platt (See page 624)

CHASE & OTIS, Court st. bridge (See page 653)

Cox J. T. & Son, North Water n. R. R.
CRAIG & CROUCHS, 4 Griffith (See page 637)

EDGERTON H. H. 207 S. St. Paul (See page 637)

HOLLISTER & CO. 102 Exchange (See page 656)

Kay Joseph H., Lake av. n. Rowe
Lovecraft J. F. & Son, Mt. Hope av.
MORSE WM. B. & CO. 30 West av. (See page 652)

PRENTICE A. & SON, 158 Lake av. (See page 650)

Plant Stands.

PAGE C. D. (evaporating), 205 East Main (See page 694)

Plaster.

GARBUTT J. W. rear Court near Exchange (See page 581)

Plasterers (Ornamental).

BROTSCH CHAS. G. 9 Andrews (See page 624)

WHALEN D. 16 Stone (See page 654)
YOUNG JAMES A. 51 South St. Paul (See page 647)

Plough Manufs.

HEWITT H. H., Platt near State (See page 673)

Plumbers.

BENNETT R. 8 Mumford (See page 643)

Cassebeer Adolph, 174 West Main
Child & Backus, 107 West Main

Gauhn & Klein, 66 East Main
GOMMENGINGER & CO. 48 Exchange (See page 617)

Howe J. H. & Co. 48 East Main
RICE EDWARD J. 16 South St. Paul (See back cover)

SHERLOCK & SLOAN, 25 Exchange (See page 623)

SIDDONS CHARLES S. 96 E. Main (See inside front cover)

TULLEY F. 67 Exchange (See page 577)

WALSH, WESTCOTT & CO. 196 State (See page 626)

Pork Packers.

DEVOS J. 44 Front (See page 551)

Potteries.

Burger & Lang, 4 Mt. Hope avenue
HAMMER JOHN M. 151 West av. (See page 576)

Schmidt John, 97 Scio

Walz John, 31 Weld

Poultry Breeders.

VAN VECHTEN J. W. 35 State (See page 579)

Presses (Hydrostatic).

Cowley Covil R. 110 State
SCHAFFER J. C. 6 Hill (See page 684)

Printers.

ALLEN & WEGMAN, 62 East Main (See opp. page 592)

ANDREWS EZRA R. 1 Aqueduct (See opp. page 512)

BOSTWICK & HEINDL, 2 E. Main (See page 524)

Brandt Louis W. 18 North St. Paul
Bryan H. D. 11 North St. Paul

Clark F. W. 57 State
EVENING EXPRESS PRINTING CO. 23 W. Main (See opp. page 528)

Falls William S. 9 Elwood block
Granger & Chapman, 19 Marietta

Hackstaff N. T. 23 Elwood block
HART ERNEST, 46 Oak (See page 592)

KEELER JAMES, Mill cor. Exchange place (See page 544)

NOLTE ADOLPH, 23 West Main (See page 521)

Ostrander A. M. 14 State

ROCHESTER PRINTING CO. 3 W. Main (See page 531)

Rodel F. W. 17 Masonic block

Smith John P. 43 Orange

Smith M. H. 33 Exchange

Spencer W. H. 51 Savannah

Stump C. H. & Co. 67 Arcade

Swinburne & Co. 90 Arcade

UNION & ADVERTISER CO. 82 W. Main (See page 530)

VACUUM OIL CO. 6 State (See opp. page 576)

WHYBREW & BACKUS, 6 State (See opp. page 576)
Williams & Jordan, 96 East Main

Printers' Materials.

ALLING & CORY, 10 Exchange (See page 528)
 DISBROW M. H. 29 West Main (See back cover)

Printers' Rollers.

DISBROW M. H. 29 West Main (See back cover)
 TAFT BROS. 146 West Main (See page 570)

Produce.

Bechteler J. B. 55 Hudson
 Brown James D. 241 East Main
 Chapin L. 48 Powers' buildings
 Cleveland H. B. & Co. 119 W. Main
 Cogswell C. H. 10 Plymouth av.
 Croft Frances, 3 Lowell
 Gordon Robert H. 79 S. St. Paul
 HALL R. D. & CO. 175 E. Main (See page 551)
 Handy E. F. 150 West Main
 Katz Jacob, 181 East Main
 McGill & Slade, 195 East Main
 McLean Alex. E. 347 State
 Sherman S. L. 171 East Main
 Sherman T. & Son, 203 East Main
 Whipple J. D. 197 East Main
 Wickens Philip, 1 Lyell

Provisions (Salt).

DeVos A. 48 Front
 DEVOS JACOB, 44 Front (See page 551)
 EAST HENRY, 24 Front (See p. 558)
 Moulson Thomas, 112 East Main
 Wohlfart Joseph M. 222 N. Clinton
 ZWEIGLE JOHN G. 45 Front (See page 553)

Pruning Shears.

LEE E. S. & CO. 19 Warehouse (See page 626)

Publishers.

DODGE & BOYD, 12 E. Main (See opp. page 640)

Pulp Manufs.

Otis S. & M. E. 129 Mill
 Rochester Wood Pulp Co. 27 N. St. Paul

Pump Makers.

Brelmeier George, 135 Lyell
 Dietz & Dusch, 309 N. Clinton
 Felt J. R. 91 East avenue
 Gill C. B. 129 Mill
 GLEICHAUF JOHN B. 37 Sanford (See page 643)
 Schwab B., Whitney corner Smith
 Stocking Daniel C. 101 Alexander

Pyrotechnists.

Palmer James, 140 East Main

Rags.

See also Paper Stock.

Hays M. A. 111 Mill
 HEY LEVI, 215 State (See page 670)
 Kelly Anton, 69 Smith
 LANEY JAS. 144 E. Main (See page 670)
 MILES HENRY & CO. 83 South St Paul (See page 669)

Railroad Lamps.

BUFFALO STEAM GAUGE AND LAMP CO. 31 State (See front colored page)
 KELLY LAMP WORKS, Mill cor. Furnace (See page 689)

Railroads.

See also Contents.

NORTHERN CENTRAL RAILROAD.—See Railroads in Contents

Razor Strop Manufs.

Lamont Bros. 35 State

Reading Rooms.

Athenæum, 40 Fitzhugh
 Young Men's Christian Ass'n, 18 East Main

Real Estate.

See also Agents.

ARNOLD H. G., Harvard c. Rowley (See page 507)
 DAVENPORT & TUTTLE, 33 Arcade (See page 509)
 MABBETT A. L. 32 Arcade (See front colored page)
 PARCE J. Y., at Fairport (See page 579)
 UPTON CLARENCE H. 22 Smith's block (See page 586)

Reapers and Mowers.

BUCKEYE REAPER & MOWER, ADRIANCE, PLATT & CO. N. Ford cor. canal (See page 677)
 ROCHESTER AGRICUL. WORKS, 100 South St. Paul (See page 675)

Register in Bankruptcy.

HUSBANDS J. D. 143 Powers' bldgs. (See page 512)

Registers (Furnace).

Glass J. H. 8 Plymouth avenue

Reporters (Law).

Crittenden W. B. 15 Powers' bldgs.
 Ludlam J. E. 15 Powers' buildings
 Osgoodby & Duffield, 133 Powers' bldgs

Re-Sawing Machines.

CONNELL & DENGLER, Mill cor. Furnace (See opp. page 551)

Restaurants.

See Eating-Houses; also Saloons.

Buckley R. A. 7 South St. Paul

Rifles and Pistols.

PHELPS & CO. 4 E. Main (See p. 618)

Roofers.

DEIGERT BENEDICT (*tin*), 97 St. Joseph (See page 627)

Fitz Simons M. H. 164 State

HOGLE FRANK M. 39 Tyler (See page 642)

KARP JACOB & SONS, 39 Rauber (See page 642)

KENNEDY H. R. (*tin*), 100 South av. (See page 627)

McCONNELL & JONES, Exchange cor. Spring (See page 657)

ROBINSON WM. (*gravel*), 48 Exchange (See page 642)

SCHLEGEL C. F. (*tin*), 92 St. Joseph (See page 627)

SIDDONS JOHN, 90 East Main (See front colored page)

Rope Walks.

CHURCH SIDNEY, 167 West avenue (See page 670)

Gessell Andrew & Son, Genesee cor. Flint

Rubber Goods.

Chamberlin Jas. R. 61 West Main

Rubber Goods Manufs.

STEWART RUBBER CO., Andrews cor. North Water (See page 666)

Rubber Hand Stamps.

ALLEN & WEGMAN, 62 East Main (See opp. page 592)

Saddle Manufs.

Zoller Jacob & Co. 1 Walbridge's blk.

Saddlery Hardware.

ROBY S. B. & CO. 80 State (See page 607)

Safe Deposit Vaults.

SAFE DEPOSIT CO. 31 State (See page 499)

Safe Manufs.

BRIGGS M. & SON, 188 State (See page 681)

MACNEALE & URBAN (H. N. Nichols and C. C. Hicks, agents), 6 Corinthian Hall bldg. (See p. 679)

WARNER, STOCKBRIDGE & CO. 18 Arcade, and WARNER, HOWARD & CO. 51 State, Chicago, Ill. (See bottom end of book)

Saleratus.

DELAND H. A. & CO., at Fairport (See page 584)

Saloons.

See also Eating Houses.

Andrews A. E. 49 Front

Auer Sebastian, 67 Front

Austin F. J. 77 Front

Babcock O. C. 188 West Main

Barons Thomas C. 30 Vincent place

Barron L. 11 West avenue

Barron M. 172 East Main

Bauer Theodore, St. Joseph c. Clifford

Bayer W. 56 Front

Becker H. L. 12 Exchange place

Begy Frank J. 21 Exchange place

Bellmont L. 130 East Main

Benedict Jas. S., State c. Railroad av.

Berg A. 246 St. Joseph n. Clifford

Bertram George, 229 North Clinton

Bingham Kleber W. 9 Hunter

Blasy John, Weeger corner Henry

Boehm J., N. St. Paul cor. Franklin

Book George, Bay cor. Webster road

Boylan Nicholas, 53 Lyell

Boyle W. 8 Pine

Brayer Stephen, 159 Jay cor. Whitney

Brookhardt Abram, 201 East Main

Buhr F. 92 North Clinton

Bullinger B. 8 Elizabeth

Burgess William, 4 Exchange place

Burrell James, 274 State

Butler George, 115 Mill

Campbell James, 240 State

Christ Joseph, 32 Franklin

Cirotzki August, 75 North avenue

Clancey Michael, 94 Exchange

Clark J. Mrs. 143 W. Main

Clark J. W. 129 State

Clements Caroline, 72 Exchange

Connaughton Peter, 5 Hunter

Connell Thos. 63 West avenue

Connors Michael, 160 S. St. Paul

Cooney Anna, 71 Front

Cooney Henry N., Goodman cor. R. R.

Corrigan P. H. 135 West Main

Crispen W. H. 64 Exchange

Cromer Margaret, 12 Oakman

Cummings Wm. 63 Orchard

Debus Catharine, 6 North Ford

Deutsch Wm. H., W. Main c. Exchange

Devitt Hugh, 62 Exchange

Diebel C. 9 South St. Paul

Donaldson Peter, 34 West avenue

Donovan Thomas, 97 S. St. Paul

Ebner Edward, Jackson cor. Green

Eckert T., Clifford near Thomas

Eckhardt C. 106 Exchange

Egan John, 163 Scio

Egerer Fred. 162 North avenue

Ehrhart & Stickline, 40 Allen

Eipper A. 30 Mumford

Endres Mary, 61 Jay

Englert C. 4 Andrews

Englert Michael, 86 St. Joseph

Erbelding Joseph, 50 S. St. Paul

Fahy Martin, 66 Exchange

Farley & Love, 32 South St. Paul

Farquhar H. T. 224 West Main

Fell John A., Water cor. Railroad

Flynn Myles, 127 West Main

HENRY C. WISNER,

BACCARAT TABLE DE SERVICE,
No. 33 STATE STREET.

Ford George, 131 State
 Forest & Favreau, 138 State
 Forkel J. C., S. St. Paul cor. E. Main
 Fortune Sarah J. Mrs. 86 Exchange
 Fosmire J. 67 West avenue
 Fowle W. K. 37 Front
 Fritz George G. 293 North Clinton
 Fuchs C. F. 123 Front
 Galli Christian, 111 North avenue
 GEHRES P. 76 North St. Paul (See
 page 596)
 Gilliard Valentine, 139 North St. Paul
 Glick John, North av. near Jennings
 Goetze Charles, 57 Lyell
 Golding D. 66 Front
 Gordon A. O. 13 Arcade
 Goulding G. P. 30 Lake avenue
 Greasley James, 41 East Main
 Gundelsheimer Caroline, 7 North av.
 Haefner Frank, Exchange c. Clarissa
 Hagele J. 5½ Wilder
 Hartel John, 10 West avenue
 Haungs Joseph, 4 West Maple
 Hayden Catharine, 206 State
 Heberger John, 112 N. Clinton
 Heilbronn C. 169 East Main
 Heilbronn Lewis, 85 Chatham
 Heilman J. D., 109 Hudson
 Heiter Charles, 33 St. Joseph
 Held Jacob, 17 Mt. Hope avenue
 Henneberger George C. 20 Stone
 Hetzel Henry, 46 Kent
 Hetzel John C. 105 East Main
 Hetzel John P. 94 West Main
 Hillard William, 234 State
 Hirsch George, N. Clinton c. Atwater
 Hitzler Mary F. 52 Mill
 Hoefler F. W. 48 South St. Paul
 Hogan Amanda, 96 Exchange
 Hohenstein John, Bank court
 Hoover M. 55 Hudson
 Hotchkiss Charles, 172 State
 Hotchkiss & Nagle, 174 State
 House George, 33 Front
 Hulett John, 173 East Main
 Hurrell S. 18 Market
 Imhof F. 124 North Clinton
 Jenny J. 43½ North Clinton
 Johnson Susan, 70 Exchange
 Johns Jacob, 60 West avenue
 Joseph Johanna, 75 Front
 Joseph William, 73 Front
 Kanane Michael, 59 West av.
 Karle J. Mrs. 58 South St. Paul
 Keller John, 156 Scio
 Keller Nicholas Mrs. 10 N. Water
 Kelly Joseph, 9 Hill
 Kernan M. Miss, 26 N. Water
 Kilian Conrad, 201 East Main
 Kimpel G. J. 82 South St. Paul
 King George D., University av. c. R.R.
 Klein John, 101 Allen
 Klein Mary, North Clinton
 Klemm Catharine, 116 West Main
 Klingler S. 184 St. Joseph
 Kodisch Henry, 8 Lowell
 Kodish John, 276 North Clinton
 Kollman George, 102 N. Clinton

Kondolf Anthony, Ames near Jay
 Krebs Frank, 13 South St. Paul
 Krieg W. 114½ St. Joseph
 Krug Henry, 154 North av.
 Kuefer B. 32 St. Joseph
 Kuttruff Stephen, 67 Mt. Hope av.
 Lawrence Samuel, 21 South av.
 Leimgruber V. Mrs. 20 N. Water
 Leonard Peter, 85 South St. Paul
 Lerch Antony, 49 N. Frances
 Lettington & Wimble, 25 Exchange pl.
 List Ferdinand, 148 Brown
 Listman C., Oak near Smith
 Luscher Samuel, 34 Pinnacle av.
 Lutt Jacob, 112 West Main
 Lynch James jr. 180 N. St. Paul
 Maeder Ernst, Jay corner Oak
 Magin Michael, 5 Andrews
 Maloy Martin, 36 Kent
 Maltzahn W. J., Bay n. North av.
 Mannes Christian, 126 South av.
 Mayer Theresa, 190 N. Clinton
 McClusky T. 138 West Main
 McCormick P., Mill c. Platt
 McCullen M. E. Mrs. 220 State
 McElrone Bernard, 27 Monroe av.
 McKay J. D. 7 Mumford
 McKown Edward J. 2 Centre
 McMullen Bridget, 31 S. St. Paul
 McVay P., Lake av. cor. Lyell
 Meier Simon, 4 Bauer
 Metzger Joseph, Emerson c. Eighth
 Meyer Fred, 88 N. St. Paul
 Miller B. W. 27 W. Main
 Mirquet Charles, 51 Front
 Monk William & Co. 239 E. Main
 Murch H. 12 North Water
 Nelligan H. J. Mrs. 248 State
 Nicholas J. G. 161 W. Main
 Nientimp Ignatz, 70 St. Joseph
 Nippert Mary M. 20 S. St. Paul
 Normille James, 170 State
 O'Connor J. 116 East av.
 O'Gorman Jennie B. 114 Lake av.
 O'Grady A. 7 Monroe avenue
 O'Keefe Margaret, 73 West Maple
 O'Shaughnessy Edward, 89 Front
 Ovenburg Roman, 1 Lowell
 Pausch Jacob, 66 W. Maple n. York
 Pfistner M. 22 South
 Pierce J. W. 146 East Main
 Pinchbeck William, 15 Monroe av.
 Pitts R. 2 West avenue
 Queltschenbach M. V. 39 Front
 Rau Gustavus, 7 Mumford
 Rauber J. 136 West Main
 Reardon D. 91 Mill
 Reinhart Abram, 92 Exchange
 Remington E. C. 16 Exchange place
 Rickard James, 57 Jay
 Ringelstein A. G. 29 Front
 Ringelstein J. 20 Exchange place
 Rogers Joseph, 40 N. Water
 Rosenthal Gustav, 107 North av.
 Ruch John, 94 Front
 Ryan William, 157 N. Water
 Sachs Louis, 160 North av.
 Sampson Henry J. 182 West av.

Sauerteig R. 27 Front
 Schaefer F. J. 89 St. Joseph
 Schlaffer V. 18 Exchange place
 Schleber J. G. 24 N. Water
 Schlitzer Leo A. 39 Andrews
 Schneider F. 143 Mill
 Schoeffel F. A. 11 South St. Paul
 Schomburg Hugo, 42 N. Clinton
 Schuey J. A. 75 Exchange
 Schwartz George M. 219 N. Clinton
 Schwendler Elizabeth, 1 Wilder
 Semmel Charles, 183 N. Clinton
 Seybold Reynold, 120 Front
 Sharp Lewis, 94 St. Joseph
 Shepard Frank D. 12 South St. Paul
 Shuey John A. 75 Exchange
 Siebert G. 14 Exchange
 Sihler John, 72 North av.
 Smith G. W. 23 Exchange pl.
 Smith John, 52 Allen
 South William, 65 Front
 Spahn Henry, 6 Mill
 Spahr Caspar, 137 State
 Sparr C. J., Bay near Goodman
 Stack John, 160 State
 Stallknecht J. 80 Front
 Standish E. A. 67 Exchange
 Stanton P. 12 Platt
 Staudenmaier John, 175 N. Clinton
 Stephany John, 249 N. Clinton
 Ster Louisa, 103 Jay
 Stoddard S. 134 Plymouth av.
 Strebler M. 22 Exchange pl.
 Strobel Pauline, 50 Ontario
 Stuvenhaver J. 8 Allen
 Sullivan Eugene, University av. n. R.R.
 Suss Christian, 70 Wilder
 Swikehard & Hondorf, 12 Exchange pl.
 Talty Julia, 92 Front
 Theis John, 54 N. Water
 Tierney M. L. 3 Monroe avenue
 TRAUGOTT WM. 35 Scio (*See page 556*)
 Troidl Jacob, Wilder cor. Saxton
 Truesdale Jenny, 59 Chatham
 Tschernich Minnie Mrs. 19 Hanover
 Van De Lende D. C. 293 St. Joseph
 Vinton E. 57 Spring
 Volkert Michael, 9 South av.
 Wagner E. 12 N. Clinton
 Wagner J. G., Hill cor. Ford
 Wallace Daniel, 88 Exchange
 Warren Eliza, 17 Market
 Waterson Alden D. 9 Monroe av.
 WEHLE CASPAR, Front c. Mumford
 (*See page 553*)
 Weidner George, 102 Front
 Weigel Anna M., Hudson c. Clifford
 Werndle V. 58 N. Clinton
 Werner George, 40 East Main
 Werner George, 261 N. Clinton
 Wheeler D. L. 18 Spring
 Wiechman Fred, 264 Brown
 Wieser George, 52 Allen
 Witzigman Lena, 173 North
 Wixted Hugh, 145 West Main
 Wolf Charles G. 78 Pinnacle av.
 Wurtz F. 228 State

Yoeman T. 1 Plymouth av.
 Zimmermann George, 78 St. Joseph
 Zuber John, Mill cor. Market

Sash Lock Manufs.

ARNOLD H. G., Harvard c. Rowley
 (*See page 507*)

Sash Manufs.

See Doors, Sash and Blinds.

Sausage Mqkers.

Auer Henry, 32 Front
 Bauer M. 52 Front
 Bauerschmidt A. 34 Front
 Mueller A. 4 West avenue
 Scheffel John, 164 South St. Paul
 WEHLE CASPAR (*wholesale*), Front
 cor. Mumford (*See page 553*)
 ZWEIGLE JOHN G. (*wholesale*), 45
 Front (*See page 553*)

Saw Filers.

Hach Smith, 129 South St. Paul
 Pfuhl Ferdinand, 38 Catharine

Saw Gummers.

Smith, Johnson & Co. 115 Arcade

Saw Hanging Manufs.

KINGSBURY & DAVIS, Mill near
 Factory (*See page 680*)

Saw Manufs.

BEISHEIM HENRY, 145 N. Water
 (*See page 674*)
 CONNELL & DENGLE, Mill cor.
 Furnace (*See opp. page 551*)
 FLINT J. 153 State (*See page 673*)
 Shipman & Binder (*bracket*), 111 North
 Water

Saw Mills.

*See also Planing Mills; also Turning,
 Sawing, &c.*

Bentley, Meyer & Southwick, rear Mt.
 Hope av. opp. Comfort
 CROUCH G. W. & C. T., South St.
 Paul near Griffith (*See page 637*)

Scale Manufs.

Forsyth & Co. 5 Andrews
 HOWE H. J. & CO. 3 Andrews (*See
 page 618*)

Scavengers.

Baker John, 3 Thorn alley
 Breck George, 75 Pinnacle av.
 YORK J. H. 22 Gregory (*See page 619*)

Schools.

For Public Schools, see Contents.

Academy Sacred Heart, Prince
 Academy of Nazareth, Jay cor. Frank
 Benjamin D. S. (*classical*), 15 Exchange
 Bliss Mary (*girls*), 33 Spring
 Bortle Seminary, Jay cor. Magne

Briggs A. O. Miss, 24½ East Main
BUSINESS UNIVERSITY, Williams
 & Rogers, proprietors, West Main
 cor. Fitzhugh (*See Schools in Con-*
tents)

Carter Ella L. (*children*), 26 Sophia
 Catholic Classical School, Frank
 Curtis C. M. Mrs. (*girls*), 45 Spring
 Dannels M. Eva (*children*), 16 Edin-
 burgh

Falls Kate A. 12 Matthews
 German Lutheran School, 20 Allen
 and Chatham near Franklin

Hale George D. 27 State
 Holland Reform Parochial School, Or-
 egon corner Harrison

Holy Family School, Jay cor. Ames
 Immaculate conception, Plymouth av.
 Marshall Margaret (*children*), 128 Ply-
 mouth

Nichols S. J. Mrs. (*girls*), 70 Fitzhugh
 Porter Almira B., East av. opp. Scio
 Reed Thomas C. Rev. 96½ East Main
 Rochester Jennie (*girls*), 66 Caledonia
 avenue

ROCHESTER REAL SCHULE (*Ger-*
man), 7 Mortimer (*See Schools in*
Contents)

St. Bonifacius School, 5 Grand
 St. Bridget's School, Sisters of Mercy,
 41 Hand

St. John's German Lutheran, Buchan
 Park near St. Joseph

St. Joseph's School, 26 Franklin
 St. Mary's Academy, Sisters of Mercy,
 5 South

St. Mary's Orphan Asylum, West av.
 St. Mary's School, Joseph Flynn, prin-
 cipal, 15 South

St. Michael's German, 292 N. Clinton
 St. Patrick's Academy, Brown
 St. Patrick's Orphan Asylum, Frank
 St. Paul's, 3 Mortimer

St. Peter and St. Paul's School, Bros.
 St. Mary's E. Maple c. King
 Sintzenich Julia M. 66 Andrews
 Stevens Nellie A. (*children*), 216 Uni-
 versity avenue

Trinity School, Frank c. Centre
 Vosburgh John R., E. Main c. Stone
WILLIAMS & ROGERS, W. Main, c.
 Exchange (*See Schools in Contents*)

Wood C. J. (*dancing*), 10½ Mumford
 Zion's School, Chatham near Franklin

Scourers.

LEARY D., Mill corner Platt (*See page*
 580)

Screw Manufs.

ROCHESTER MACHINE SCREW
CO., Mill cor. Furnace (*See page*
 677)

Sculptors.

Mundy J. M. 103 Arcade

Seamstresses.

Avery Susan, 35 Tremont
 Braithwaite Mary, 38 Lake avenue
 Collins Christina Miss, 25 Lime
 Darling Laura M. 20 Matthews
 Fein Louisa Miss, 50 Scrantom
 Fox Mary E. 23½ Romeyn
 Gray Eliza, Averill near Cobb
 Hertel M. M. 432 Brown
 Huber Clara, 25 Oakham
 McManis A. Miss, 77½ North
 Mura May E. 37 Whitney
 Reger Sarah, 124 Jay
 Rohr A. Miss, 54 Ontario
 Tines Mary L. 31 Lime
 Walker E. Miss, 25 Stillson

Seedsmen.

See also Nurserymen.

Boardman S. & Co., Minerva alley
BRIGGS & BROTHER, 93 State (*See*
page 534)

CHASE BROS. 1 East Park (*See page*
 526)

CROSMAN BROS. 300 Monroe av.
(See page 516)

McMAHON & HAGAMAN, 159 West
 Main (*See page 587*)

REID W. H. 166 State (*See page 593*)

VICK JAMES, State corner Market
(See page 533)

Sewer Contractors.

McCONNELL & Jones, Exchange cor.
 Spring (*See page 657*)

WHITMORE, RAUBER & VICINUS,
 175 S. St. Paul (*See page 659*)

Sewer Pipes.

BUTLER W. G., Olean opp. Frost's
 nurseries (*See page 661*)

COPELAND D. jr. 90 S. St. Paul (*See*
page 658)

OTIS & GORSLINE, 51 Powers' bldgs.
See page 655)

Sewing Machine Re- pairers.

MILLER CHRISTIAN, 107 N. Water,
(See page 674)

Sewing Machines.

DOMESTIC SEWING MACHINES,
 Mrs. James Henderson, agent, 52
 State (*See page 548*)

Finkle C. E. 40 East Main
HOWE SEWING MACHINE CO.,
 C. S. Todd, agent, 69 State (*See*
page 578)

Kellogg J. M. 94 East Main
 Mayloy E. C. 57 State
 Myers Isaac, 54 North Clinton
 Ranch J. J. 197 North Clinton
SINGER SEWING MACHINE, Jones
 & Sugru, agents, 43 State, (*See*
page 549)

A. R. PRITCHARD & LIKLY,

CANS AND UMBRELLAS.
 No. 78 STATE STREET.

Tinker Horace, 124 West Main
WEED SEWING MACHINE, T. S.
 Maxwell, manager, 18 East Main
 (See page 546)
WHEELER & WILSON, S. W. Dible
 & Dutton, agents, 20 East Main
 (See page 538)
WILCOX & GIBBS SEWING MA-
CHINE CO. 12 Allen (See page 592)

Shell Boat Builders.

SMITH CHAS. L. opp. 53 Mt. Hope
 avenue (See page 576)

Shingle Machinery.

GREENWOOD JOHN & CO., Mill n.
 Platt (See page 688)

Shingles.

HOLLISTER & CO. 102 Exchange
 (See page 656)
PRENTICE A. & SON, 158 Lake av.
 (See page 650)

Ship Chandler.

Field James, 42 Exchange

Shirt Manufs.

BEEMER M. V. 18 West Main (See
 page 541)
 Birdsall D. Miss, 141 Powers' bldgs.
 Hubbard W. E. 110 State

Shoes.

*For anything connected with this business, see
 Boots and Shoes.*

Show Card Mounter.

GIVENS THOMAS, 114 Front (See
 page 518)

Show Cards.

ENNECKER & KARLE, 35 State (See
 opp. page 624)
MENSING, RAHN & STECHER, 7
 Market, (See opp. page 544)

Show Cases.

RICE PETER, 87 South St. Paul (See
 page 517)
 Schang John, 53 Front
STEIN SHOW CASE WORKS, Ex-
 change cor. Court (See page 621)

Silver Platers.

Mayo W. G. 31 Smith's block
MORRIS J. M. 14 State (See page 514)
ROCHESTER PLATING WORKS,
 122 Mill (See page 670)
SARGENT & GREENLEAF (nickel),
 Court cor. Stone (See front colored
 page)

Silversmiths.

Maffett F. W. 2 East Main
 Steele J. P. 1 Aqueduct

Silverware.

BOOTH E. B. & SON, 5 State (See
 page 514)
ETTENHEIMER E. S. & CO. 2 State
 (See page 515)
HAY JOHN & CO., 53 W. Main (See
 page 516)
NOVELTY SUPPLY CO. 16 Madison
 (See page 619)
ROSENBERG H. & D. 11 State (See
 page 515)
SUNDERLIN & McALLASTER, 18
 State (See page 516)
WISNER HENRY C. 33 State (See
 foot lines through book)

Slate Roofers.

KARP J. & SONS, 39 Rauber (See
 page 642)

Sleeping Cars.

HOYT WM. E. 100 Railroad av. (See
 Railroads in Contents)
LEWIS R. S. 95 Waverley block (See
 Railroads in Contents)
 Ray Robert, N. Y. C. & H. R. R. depot

Slippers.

END F. 7 Andrews (See page 667)

Soap Manufs.

Goetzmann & Son, Wentworth c. New
 York
McINTOSH, AIKENHEAD & CO.
 55 Front (See page 553)
 Metcalf Arnold, West av. n. Hague
 Moulson S. 50 Front
 Talman J. 168 South St. Paul
THOMPSON H. at Buffalo (See p. 585)
 Weilhamer C. T. 90 North avenue

Soda.

DeLAND H. A. & CO., Fairport
 (See page 584)

Spices.

MOORE C. T. 14 Front (See page 550)
VAN DeCARR R. D. 31 Exchange
 (See page 597)
VAN ZANDT B. B. 112 State (See opp.
 page 550)
VAN ZANDT M. N. & CO. 11 West
 Main (See page 573)

Spoke Manufs.

CORRIS WILLIAM & CO. Elizabeth
 cor. Hill (See page 607)

Sporting Apparatus.

PHELPS E. S. 4 E. Main (See p. 618)

Spring Beds.

PAGE C. D. 205 East Main (See p. 694)
 Steele & Co. 43 East Main

Stables.

BOARDING.

Bennett L. J. 117 West Main
Curtice Z. C. & Co. rear 1 Franklin
Day James, 4 Otsego
Howe D. W. 17 Andrews
Mann G. A. 309 State
Mason John C. 279 State
MASSETH FRANK X. 15 Fitzhugh
(See page 606)
McCourt Chas. 1 Ely
Wanmaker F. F. r. 118 W. Main
WRIGHT I. N. 17 Division (See page 602)

HACK.

FRICK JOHN H. 47 S. St. Paul (See page 608)
GREENNAGEL M. 6 Lancaster (See page 602)
Hamlin Lovell, rear 8 Jackson
MASSETH FRANK X. 15 Fitzhugh
(See page 606)

LIVERY.

Campbell Wm. jr. rear 147 E. Main
Daniels E. H. & Son, 4 Caledonia av.
FRICK J. H. 47 S. St. Paul (See page 608)
Gould J. & Son, 11 Andrews
GREENNAGEL MICHAEL, 6 Lancaster (See page 602)
Heavey M. 83 Front
Hynes Michael, 88 North Water
MASSETH FRANK X. 15 Fitzhugh
(See page 606)
Masseth George, 171 State
Morgan Owen, 89 Mill
Ransom H. S. 3 Stone
Smelt Wm. 7 Ely
Spear J. B. 4 Franklin
WRIGHT I. N. 17 Division (See p. 602)

SALE.

Bantel George, 142 Lake avenue

Stained Glass.

See Glass Stainers.

Stair Builders.

Corlett Matthew R. 11 George
Smith William G. 4 Caspar

Stamping and Braiding.

ZELLWEGER BROS. 117 W. Main
(See page 544)

Stamps.

ALLEN & WEGMAN, 62 East Main
(See opp. page 592)

Staple Manufs.

Gage G. A., Mill cor. Platt

Stationers.

ANDREWS E. R. 1 Aqueduct (See opp. page 512)
DARROW ERASTUS, 67 East Main
(See page 518)

GROSVENOR O. D. 75 State (See page 519)

Merk Wendelin, 5 N. Clinton
MERRIAM & CO. 40 West Main (See page 518)

STEELE & AVERY, 44 State (See page 519)

STRATTON G. L. & CO. 61 State
(See page 529)

Stave Machine Knives.

GREGG M. foot Falls (See page 676)

Staves and Hoops.

Bush J. F., Oak near Jay
Clark Brackett H., Lyell cor. canal
LOVECRAFT WILLIAM, 92 Allen
(See page 671)
PORTER SAMUEL, Oak cor. Smith
(See page 671)

Steam Bakeries.

FLECKENSTEIN BROS. Brown c.
W. Maple (See page 573)

Steam Boats.

BENNETT S. & SON, Lower Falls
(See page 647)
NORSEMAN, R. Crawford, master,
Charlotte (See Steamboats in Contents)

Steam Boilers.

KELLY PETER, Mill near Platt (See page 672)
WOODBURY, BOOTH & PRYOR,
138 Mill (See page 687)

Steam Engines.

GRAVES L. S., Mill cor. Factory (See page 690)
WOODBURY, BOOTH & PRYOR,
138 Mill (See page 687)

Steam Fittings.

BEACH J. S. 17 Mill (See page 625)
BENNETT R. 8 Mumford (See page 643)
SHERLOCK & SLOAN, 25 Exchange
(See page 623)
SIDMONS C. S. 96 E. Main (See front colored page)

Steam Heating.

COOK E. H. & CO. 11 Exchange (See page 617)

Steam Pumps.

SHERLOCK & SLOAN, 25 Exchange
(See page 623)

Stencil Cutters.

Monroe R. B. 43 East Main
MORSE C. H. 69 State (See page 625)

A. R. PRITCHARD & LIKLY,

*Steamer Trunks--Something New,
No. 78 STATE STREET.*

Stereoscopes.

- BRADLEY P. B. 118 Front (See page 523)
WOODWARD C. W. 126 State (See page 532)

Stereotype Foundry.

- ALLEN & WEGMAN (rubber), 62 East Main (See opp. page 592)
LENNOX JAMES, 24 Front (See page 521)

Stock Companies.

- Bartholomay Brewing Co. 139 North St. Paul. Organized 1874. Capital \$250,000.
BARTON D. R. TOOL CO., Mill cor. Furnace. Organized 1875. Capital \$150,000 (See page 676)
Bausch and Lomb Optical Co. 179 N. St. Paul
BUFFALO STEAM GAUGE AND LAMP CO. 31 State (See front colored page)
CITIZENS' GAS CO., office No. 15 North St. Paul. Incorporated 1872. Capital \$500,000 (See page 493)
EQUITABLE CO-OPERATIVE FOUNDRY CO. 8 Hill. Capital \$100,000 (See page 614)
EVENING EXPRESS PRINTING CO. 23 West Main. Organized 1874. Capital \$100,000. (See opp. page 528)
Hatch Patent Crimper Co., River cor. N. Water. Organized 1873.
HOP BITTERS CO. 50 Mill. Organized 1873. Capital, \$125,000 (See page 596)
KELLY LAMP WORKS, Mill n. Furnace (See page 689)
Kidd Iron Works, 106 Mill
Reynolds Fruit and Vegetable Evaporation Co. 92 Mill. Org. 1876. Treas., C. M. Cole. Sec., George Schofield
ROCH. ADMANTINE BRICK CO. 5 Masonic block. Incorporated 1873. Capital \$100,000 (See page 638)
ROCHESTER BREWING CO. ft. Cliff (See page 562)
ROCH. BRICK & TILE MANUF. CO. 51 Powers' bldgs. Capital \$84,000 (See page 638)
ROCHESTER FREAR STONE CO. Mt. Hope avenue. Incorporated 1873. Capital \$200,000 (See p. 650)
ROCH. GASLIGHT CO., office and works Mumford c. Genesee river. Incorporated 1848. Capital \$700,000 (See page 492)
ROCH. GERMAN INSURANCE CO. Rochester Savings Bank building. Capital \$200,000 (See page 691)
Rochester Hydraulic Power Co. North Water cor. River

- Rochester Iron Manufacturing Co. 33 Mill. Capital \$300,000
ROCHESTER MACHINE SCREW CO., Mill cor. Furnace. Capital \$7,500. (See page 677)
ROCH. PAPER CO., Lower Falls. Incorporated 1864. Capital \$175,000 (See page 521)
ROCH. PRINTING CO. 3 W. Main (See opp. page 531)
Roch. Wood Pulp Co. rear North St. Paul n. Clifford. Capital \$50,000.
RURAL HOME PUBLISHING CO. Arcade. Organized 1873. Capital \$49,500 (See under Blocks, Buildings, etc.)
SILL STOVE CO. 187 West Main. Incorporated 1873. Capital \$125,000 (See page 615)
Sprague Can Opener Co. 89 North Water. Organized 1874. Capital \$50,000
STEWART RUBBER CO., 1 Andrews. Organized 1873 (See page 666)
UNION AND ADVERTISER CO. 82 West Main. Incorporated 1872. Capital \$300,000 (See page 530)

Stone Quarries.

- Brown Henry S. 142 Hudson
BUTLER W. G., Olean opp. Frost's nurseries (See page 661)
Mc Menony P. J. r. 131 N. St. Paul

Stone Yards.

- EHRSTEIN BROS., Oak c. Smith (See page 639)
HOLLOWAY & NORMINGTON, 8 West avenue (See page 638)
PITKIN P. 22 West avenue (See page 660)
Powers James, 97 North St. Paul
ROCHESTER FREAR STONE CO. Mt. Hope av. (See page 650)
WHITMORE, BRADY & CO. 54 Fitzhugh (See page 653)
WHITMORE, RAUBER & VICINUS, 175 S. St. Paul (See page 659)
Williams & CO. 46 Exchange

Stove Manufacturers.

- CO-OPERATIVE FOUNDRY CO. 8 Hill (See page 614)
GALUSHA N. H. 20 Court (See page 693)
GEDDES WM. B. (furnaces), 29 Exchange (See page 616)
SILL STOVE CO. 187 West Main (See page 615)

Stove Repairers.

- Kirkpatrick Robert, 1 Spring
Moran Thomas, 50 Genesee

Stoves and Tinware.

- See also Furnaces; also Tinsmiths.
BAMBER JOHN, 11 Monroe avenue (See page 593)

Bingham, Bemis & Rogers, 57 State
 Boyd & Tubbs, 153 East Main
 Braun John, 121 Lyell
 CAMPBELL JAS. 83 Exchange (See page 626)
 Cannaby William, 106 Plymouth av.
 Churchill A. & Co. 71 State
 Cook John T. 263 State
 DEIGERT B. 97 St. Joseph (See page 627)
 Flad Charles, 196 East Main
 French J. M. 76 East Main
 GALUSHA N. H. 20 Court (See page 693)
 Gommenginger & Co. 48 Exchange
 HINMAN P. M. 16 South St. Paul (See page 627)
 KENNEDY H. R. 100 South avenue (See page 627)
 Kewin William, 97 East avenue
 Klein F. 66 East Main
 Lester H. 174 West Main
 Moran William, 108 West Main
 O'Connor & Kuttruff, 55 Monroe av.
 Pool James F. 266 State
 Rodenback F. C. Mrs. 13 South av.
 SCHLEGEL C. F. 92 St. Joseph (See page 627)
 Schultz Louis C. 70 North avenue
 SILL STOVE CO. 187 West Main (See page 615)
 Smith & Poppy, 72 West avenue
 Snyder & Meyer, 48 East Main
 Stewart, Woodcock & Co. 15 West Main
 Suess Emanuel F. 74 North avenue
 TROTTER & STONE, 29 Exchange (See page 626)
 TULLEY F. 65 Exchange (See page 577)
 Vosburgh H. P., Saxton near Maple
 Walker F. R. 8 South St. Paul
 Walter J. A. P. 100 Hudson
 WARRANT & SOUTHWORTH, 26 S. St. Paul (See inside back cover)
 WESTCOTT & HOUSTON, 196 State (See page 626)
 White Edmund, 225 East Main

Street Contractors.

See also Contractors.

DAVIS DANIEL P. 73 S. St. Paul (See page 591)

Street Sprinklers.

McConnell & Pringle, 107 S. St. Paul

Subscription Books.

GLOVER C. (Appleton's), 42 State (See page 593)
 MAY E. B. (European), 45 East Main (See page 593)

Surveyors.

See Civil Engineers.

Tailors.

See also Clothing.

BOONE T. R. 20 West Main (See page 543)
 BORNEMAN BROS. 8 North Clinton (See page 537)
 Brown James M. 83 Lyell
 Clarkson G. G. 54 West Main
 Claver J. C. 17 Front
 Cohen Jacob, 40 East Main
 COX WM. 17 Front (See page 538)
 Cullen J. K. 55 East Main
 Derrick Timothy, 14 Elwood block
 Dilg William, 40 East Main
 Eismann B. 42 Madison
 Fell George B. 79 State
 Gall Alexander, 79 State
 Gamwell C. H. 43 East Main
 GARSON H. & SON, 75 East Main (See page 543)
 Goodrich & Witherspoon, 8 West Main
 Haag N., Orange corner Walnut
 Hall Henry, 73 Sanford
 Harrison Henry, State cor. Brown
 Helfer Jacob, 287 North Clinton
 HENDERSON JAMES, 82 West Main (See page 539)
 Hetzler George A. 65 St. Joseph
 Hetzler John, Grape cor. Romeyn
 Hetzler V. 73 North Clinton
 Jehle O. 86 S. St. Paul
 Karg Gebhard, 172 Jay
 Kelly T. F. 124 West Main
 KENNEDY JAMES, 8 Mumford (See page 537)
 Kinzell George, 50 Pinnacle avenue
 Knapp F., Thomas near Clifford
 Kolb & Oberg, 9 East Main
 Kuhlman John, 3 Oregon
 Lehrscholl Charles, Ames near Jay
 Lindgren & Walker, 28½ East Main
 Madden J. 247 State
 Mahoney Patrick, 57 State
 McCAULEY J. F. 35 State (See page 536)
 McDonough Edward, 65 Smith's blk.
 McGUIRE W. D. & CO. 8 Elwood block (See page 536)
 McRODEN & CO. 23 East Main (See page 539)
 MILLER J. H. 6 Exchange place (See page 536)
 Moore Francis, 24 Vincent place
 MOORE & McNERNY, 60 East Main (See page 537)
 Morgenroth S. 68 Smith's block
 MORTON J. & CO. 21 East Main (See page 539)
 Mylrea J. 57 State
 Neuwirth Christian, 231 Brown
 NUNNOLD JACOB, 1 Front (See page 539)
 PARSELLS W. W. 12 West Main (See page 536)
 Parshall D. S. 55 East Main
 Rapp William, 35 State
 Richter Frank C. 93 South avenue

Schmitt John, 45 Vienna
 Seeley & Edgar, 6 State
 SHANNON M. 12 E. Main (See p. 543)
 Siegler A. 108 Chatham
 Sontag W. G. 7 North Clinton
 SPINNING J. N. 128 West Main
 (See page 587)
 Steger J. B. 223 Brown
 STEINFELD E. 15 East Main (See
 page 543)
 Stetzenmeyer Jacob, 65 Bartlett
 STORMS G. N. 10 West Main (See
 page 537)
 Suhr Charles, 105 Hudson
 Sullivan J. O. 123 Broadway
 Sutherland S. R. 14 State
 Theim M. 204 North Clinton
 Thompson Cynthia, 170 North
 Vogler W. 31 Lowell
 Walters & Davis, 1 Smith's blk.
 Waterstraat A. 6 Rauber
 Way A. C. 9 Sophia
 Weber Christian, 9½ Wilder
 Wirth Frederick, 1 Oakman
 Wollenhaupt E. 54 Wilder
 Zaches John, 290 Brown

Tallow Dealers.

McINTOSH, AIKENHEAD & CO.
 55 Front (See page 553)

Tanners.

See also Leather Dealers.

ALLING BROS. 51 North Water (See
 page 665)
 CARING, WEICHER & CO. 87 N.
 Water (See page 665)
 Fenwick T. 44 North Water
 KALB, HAHN & CO. 5 Mumford
 (See page 667)
 Kalb John, 6 North Water
 Kenngood Fred, Bay near plank road
 LAMPERT H. 81 North Water (See
 page 667)
 Trenaman R. 18 North Water
 Wolff F. & Co. 29 North Water

Taxidermists.

Fraine Thomas W., Joslyn park
 Hudson Richard, 18 Philander

Tea Stores.

MOORE C. T. 14 Front (See page 550)
 MOORE & COLE (Great American
 Tea Co.), 72 West Main (See p. 574)
 Ramsey William, 119 East Main
 VAN ZANDT B. B. 112 State (See
 opp. page 550)
 VAN ZANDT M. N. & CO. 11 West
 Main (See page 573)

Teachers.

See also Schools.

COMMERCIAL SCHOOL.

Williams & Rogers, West Main corner
 Exchange

DANCING.

Britton A. R. 6 State
 Cobleigh A. M. 211 Powers' bldgs.

DRAWING.

Vosburgh Sarah J. 16 King

LANGUAGES.

Bonnet Francoise L., Gold near Mt.
 Hope avenue
 Duboc Clara A. 185 Alexander
 Guebella Emilie, 24 East avenue
 Propping Ferdinand, 45 Andrews

MUSIC.

Abby Charlotte A. 2 Lawrence
 Appy Henri, 68 East Main
 Baker A. E. Mrs. 11 Lancaster
 Barrett S. E. Miss, 94 Fulton avenue
 Bauer Francis J. 54 Andrews
 Bennett Emma M. 29 Jay
 Betz Valentine, Laburnam near Mon-
 roe avenue
 Brockway C. M. 22 Caledonia av.
 Buell Addie, 159 Alexander
 Cary C. S. P. Mrs. 191 Powers' bldgs.
 Chadwick John M. 16 East Main
 Clapper H. J. Miss, 18 Kent
 Clark F. E. Mrs. 102½ East Main
 Clark F. P. 79 Adams
 Coakley Lotta, 26 Smith
 Connolly Julia, 17 Marshall
 Cowles Emma Mrs. 123 Scio
 Crittenden Claude, 72 Lake avenue
 Doolittle Mary A. 15 Gibbs
 Doxtater Harriet E. Miss, 8 Frank
 Edelman M. A. Mrs. 4 Wilson
 Esemann Gustavus, 18 Tyler
 Fawcett Belle C. 12 Spencer
 Foster S. O. 38 Greig
 Fuller Marianne, 55 Troup
 Gaylord Mary E. Miss, 50 Jones
 Gifford Fanny, 34 Ward
 Graham Margaret Mrs. 102½ Allen
 Greenhalgh T. 108 Tremont
 Haak L. 82 State
 Hale M. E. 75 East Main
 Harris Geo. B. Mrs. 76 Kent
 Haver L. C. Miss, 62 Court
 Hough Mary, 84 North Union
 Jones Caroline Miss, 62 Caledonia av.
 Kalbfleisch J. H. 121 Powers' bldgs.
 Kanhooyer Wm. 86 Atwater
 Karle John J. 58 South St. Paul
 Kearney Alice, 7 Gardiner park
 Kendrick Anna A. 89 South avenue
 Leach H. E. 125 Powers' buildings
 Maher Anna A. 44 Romeyn
 McCartney Cornelia Miss, 22 Grove
 McNab Sarah, 52 Hamilton place
 McNeal L. E. 14 Tremont
 Meldola T. 15 Vienna
 Meyering Charles F. 88 North St. Paul
 Monaghan Mary A. 6 Mortimer
 Otis Elizabeth, 24 Chestnut
 Phelps H. E. 179 Powers' buildings
 Pinkham Addie T. 103 Alexander
 Reynolds C. E. 193 Powers' buildings
 Roberts Hattie I. 11 Greenwood av.

Robinson H. G. 98 Frank
 Robinson Julia H. 98 Frank
 Rockwell Victoria, 31 Alexander
 Roderick Emma, 35 Fitzhugh
 Sauer Mary J. 58 Hickory
 Schenck H. & Sons, 191 Powers' bldgs.
 Schoepper Charles, 106 Orchard
 Schultz O. L. 39 Atwater
 Sheldon Edna M. 7 Sibley's block
 Sherwood Edgar H. 82 State
 Sike Charles, 2 Asylum
 Smith William, 10 Scio
 Spooner Katharine M. D., St. Mary's
 Hospital

Staples H. A. 16 East Main
 Webster S. A. 16 Mathews
 Webster Wm. Mrs. 9 John
 Wilder Nellie A. 12 Tappan
 Wilkins Herve D. 107 West Main
 Wilkinson S. T. 16 Tyler
 Wood William L. 36 Madison

PAINTING.

COOLIDGE C. M. 124 E. Main (See page 568)

Dutcher Libbie, 18 South Clinton
 Jeffrey Agnes, 83½ Fitzhugh
 Stanton Elizabeth, 37 Adams
 Taylor M. E. 46 Caledonia avenue

WAX WORK.

Gardner Frances, 42 Hamilton place
 Sornborger M. M. 5 Centre park

Teamsters.

See *Truckmen.*

Telegraph Offices.

Atlantic and Pacific Telegraph Co., T. J. Smith, manager, 7 Arcade
 Western Union Telegraph Co., A. Cole Cheney, manager, 11 Arcade

Tents.

FIELD JAS. 42 Exchange (See page 648)

Thermometer Makers.

TAYLOR BROS. 3 Hill (See page 669)

Threshing Machine Manufs.

GLEN & HALL MANUF. CO., South Water (See page 675)

Ticket Agents.

See *Transportation Agents.*

Tight Coopers.

BROWN & ROBINSON, 30 Canal (See page 678)

Tinsmiths.

See also *Stoves and Tinware.*

Brown W. H. 133 North avenue
 Buchhecker F. 75 North Clinton
 Cook Levi, 36 Tappan
 Dawe & McCormack, 328 State
 HINMAN P. M. 16 South St. Paul (See page 627)

Horn Frank, 276 Brown
 Knowles John W. 13 South avenue
 Long J. B. 79 South St. Paul
 Maier Frank, 228 North Clinton
 Meyer G. 205 North Clinton
 MILLINGTON & THOMAS, 2 Ely (See page 674)
 Murdock H. 122 State
 Salyerd Henry W. 48 North avenue
 Schaub E. E. 208 W. Main
 Spencer, Stalker & Clinch, 104 E. Main
 WARRANT & SOUTHWORTH, 26 S. St. Paul (See inside back cover)

Tobacco Manufs.

GUCKER C. & G., Mill cor. Factory (See page 565)

HESS S. F. 7 Exchange (See page 566)

Kellogg R. D. & Co. 192 State

KIMBALL WM. S. & CO., 53 South St. Paul (See page 565)

WHALEN R. & T. 182 State (See page 566)

Tobacconists.

See also *Cigar Manufacturers.*

Beir & Co. 12 Arcade
 BLOXSON AUGUSTUS C. 319 State (See page 564)

Combs A. J. 2 S. St. Paul

DAMON M. J. 3 Eagle (See page 565)

De Rojer Carlos, 126 W. Main

GARIN & MEAGHER, 147 East Main (See 564)

Gruber L. 77 N. Clinton

Hyde John, 10 Exchange place

Kellogg R. D. & Co. 192 State

Kendall S. H. 87 North av.

Kerngoods, 49 East Main

KIMBALL WM. S. & CO. 55 South St. Paul (See page 565)

Lathrop G. W. 148 State

Lavigne A. 61½ Lyell

McIntosh John, 6 E. Main

McMorrow John A. 238 State

McSweeney Edward, 3 S. St. Paul

Mickle Wm. & Co. 178 W. Main

Murenburg M. 108 St. Joseph

Pomeroy C. H. 25 E. Main

Ward Frank R. 113 State

Ward Wm. J. 230 State

Warncke Emily, 191 North Clinton

Watson Charles, 84 West Main

WHALEN R. & T. 182 State (See page 566)

Williams S. 97 Frank

Wolf J. E. 21 Front

Zorsch F. jr. 104 North Clinton

Transportation Agents.

See also *Agents.*

FELL A. (*Blue Line*), 166 State (See *Railroads in Contents*)

HARRIS B. F. (*Eric R'y.*) 4 State (See *Railroads in Contents*)

HOYT WM. B. (*Canada Southern*), 100 Railroad av. (*See Railroads in Contents*)
 Lewis R. S. (*G. W. & Mich. R. R.*), 95 Waverley block

Travelling Bags.

PRITCHARD A. R. & LIKLY, 78 State (*See foot lines through book*)

Tree Manufs. (Boot)

DUFNER JOHN, Mill near Factory (*See page 663*)

Tree Pruner Manufs.

LEE E. S. & CO. 19 Warehouse (*See page 626*)

Truckmen.

Bend Samuel, 49 Scio
 Burkhart M. 70 North Clinton
 Creelman M. T. 16 Cliff
 Doran Wm. 18 Almira
 Haag John, 160 Jay
 HAHN GEO. 13 Andrews (*See page 604*)
 Kocher J. H. 14 Green
 LEE F. A. 4 State (*See page 605*)
 Little Frank R. 18 Wilder
 Marsh Alfred, 77 Magne
 McMullen Bros. 4 Exchange
 Nolan Peter, 24 Cliff
 O'Connors Michael, 138 Jones
 Stewart William, 341 State
 Van Dusen Curtis, Lyell near Childs

Trunks.

PRITCHARD A. R. & LIKLY, 78 State (*See foot lines through book*)
 Savage A. 72 State
 SMITH A. V. & CO. 65 State (*See page 605*)

Truss Hoop Makers.

Force Isaiah F. rear 62 East avenue

Truss Manufs.

Hotchkin G. W. 145 Powers' bldgs.

Turning, Sawing, &c.

BANTLEON D. 123 North Water (*See page 649*)
 Bortle Morris, Aqueduct
 DANFORD ALLEN & SON, North Water cor. railroad (*See page 558*)
 GALLIGER M. 3 Aqueduct (*See page 576*)
 LUCREE MORRIS, Ames c. Campbell (*See page 590*)
 Roodenburg J. C. (*ivory*), 40 East Main
 Schmidt John G. 135 North Water
 Schuler Charles F. 131 N. Water

Umbrellas.

Anderson J. M. (*repairer*), 25 Gibbs
 Bowans A. (*repairer*), 113 North av.
 Carle Peter, 115 State
 Hebard R. 48 Monroe avenue
 Houston & Draper, 3 Elwood block
 Loyson A. (*repairer*), 6 Stepheny's park

Undertakers.

Bender H. & P. 102 East Main
 FOEHNER & MAIER, 4 N. Clinton (*See page 568*)
 HOFFMAN & MAYER, 10 Allen (*See page 568*)
 JEFFREYS C. V. 125 State (*See page 608*)
 Joyce & Moran, 206 West Main
 MUDGE A. W. 121 West Main (*See front colored page*)
 O'Reilly B. 127 State
 Punch Wm. 4 South Clinton
 SOUTHALL & COOK, 116 Front (*See page 611*)

Undertakers' Trimmings

SOUTHALL & COOK, 116 Front (*See page 611*)

Upholsterers.

Delby Moses, 5 Stone
 HARLFINGER CHARLES, 129 N. Clinton (*See page 628*)
 HAYDEN C. J. & CO. 184 and 186 State (*See page 613*)
 HUNN, SPENCER & CO. 74 State (*See page 612*)
 Lewis W. 205 East Main
 O'DONOUGHUE JAMES & CO. 42 East Main (*See page 628*)
 SCHANTZ, MINGES, SHALE & CO. 15 N. Water (*See page 622*)
 SCHIFFNER ALBERT, 50, East Main (*See page 629*)
 VEYHL & BARTHOLOMEW, 9 Front (*See page 622*)
 WEGMAN J. B. & CO. 44 East Main (*See page 629*)
 Zoller Chas. C. 1 North avenue

Upholstery Trimmings.

SARGENT H. D. & CO. 98 East Main (*See page 645*)
 VOGT A. 44 Exchange (*See page 645*)

Varnish and Japan.

SOUTHALL & COOK, general agents for Berry Bros. 116 Front (*See page 611*)

Vase Manufs. (Iron)

CO-OPERATIVE FOUNDRY CO. 8 Hill (*See page 614*)
 PALMER THOS. G. 87 Front (*See page 662*)
 VICK JAMES, 60 State (*See page 533*)

Ventilation.

COOK E. H. & CO. 11 Exchange (See page 617)

Veterinary Surgeons.

Britton Alonzo, Osburn House
 Carrier N. W. 62 E. Main
 Carrier W. H. 62 East Main
 Carroll John H. 10 Savannah
 Cutting Edward A. 5 North avenue
 CUTTING WILLIAM, 5 North av.
 (See page 602)
 Harrison D. B. 8 Sherman
 MCKENZIE J. C. 1 Allen (See page 558)
 Mink E. 14 Spring
 Rogers G. G., Monroe avenue n. canal
 Tegg Albert, 309 State
 Tegg John J. 5 Smith

Vinegar Manufs.

See also Cider Makers.

Deutsch Charles M. 7 Clarkson
 DUFFY W. B. & CO. 10 White (See page 594)
 Eisemann L. J. 73 Nassau
 GOETZMANN HENRY, 19 Pinnacle avenue (See page 555)
 Mann Gregory, 68 Orange

Wagon Makers.

See also Carriage Makers.

BAGLEY JACKSON, 17 North av.
 (See page 603)
 Barnes J. E. jr. 277 State
 Boorman R. M., Brown cor. West av.
 Calihan T., Franklin
 Cawthra & Barnes, Lake av. c. White
 Comons William, 6 Plymouth av.
 CUNNINGHAM JAMES & SON, 3 Canal (See page 610)
 DWYER MICHAEL, 26 Vienna (See page 603)
 Emmerich John J. 125 North St. Paul
 Goetzmann Frederick, 170 St. Joseph
 Groves Thos. B. 8 Centre
 Harris M. A. (sleighs), 17 Division
 Higgins Wm., Champion
 Hoffman H. 35 S. St. Paul
 Hudson J. W. 194 West Main
 Hughes Wm. 71 East avenue
 Keeler T. J. 9 Ely
 Klimm M. 134 Lyell
 Lane Geo. 16 Market
 Marx M., Favor near West avenue
 McDONOUGH J. H., Mortimer cor. N. Water (See page 606)
 Pehl C. 55 Fitzhugh
 Prost Philip, 170 East Main
 Seitz Lucus, 249 East Main
 Weigand M., Goodman cor. E. Main
 Zimmer Wm. 11 Mt. Hope avenue
 Zwack Michael, 16 Market

Watch Key Manufs.

WALLDORF L. 54 East Main (See page 514)

Watches and Jewelry.

BOOTH E. B. & SON, 5 State (See page 514)
 Bradley Joseph H. 88 S. St. Paul
 Clackner A. S. 291 State
 Dennebecq C. 142 East Main
 Dittmeier John, 143 East Main
 ETTENHEIMER E. S. & CO. 2 State
 (See page 515)
 Ford P. 146 State
 FOX JOHN T. 3 State (See page 592)
 Gefell Edward, 114 North avenue
 Goodger John H. 295 State
 Gutmann M. L. 38 William
 Hagen Oliver, 35 Powers' buildings
 Haskins R. T. 163 East Main
 HAY JOHN & CO. 53 W. Main (See page 516)
 Jettles & Leseritz, 107 Powers' bldgs.
 Lippert M. 150 North
 Moulton M. 3 Powers' bldgs.
 Otto F. 115 State
 Parmely Almira Mrs. 37 Stone
 Reichert J. 3 Union alley
 Rickarts C. W. 104 N. Clinton
 ROSENBERG H. & D. 11 State
 (See page 515)
 Rowley David, 11 Adams
 Skillman J. 35 West Main
 Stickney Samuel C. 32½ Franklin
 Stritt Gustave, 126 W. Main
 SUNDERLIN & McALLASTER, 18 State (See page 516)
 WALLDORF LOUIS, 54 East Main
 (See page 514)
 WHEELER WESLEY, 6 Masonic Hall bldgs. (See page 508)
 Williams H. C. 324 State
 WOLTERS C. F. 30 West Main (See page 577)

Water Filters.

INGRAHAM W. L. 77 Exchange (See page 513)

Water Line.

GARBUTT J. W. 85 Exchange (See page 581)

Water Pipes.

THOMAS E. L. 93 South St. Paul (See page 588)

Water Wheels.

FINZER & ZARGES, 13 S. Water (See page 676)
 JONES EZRA & SON, Brown's race (See page 683)
 PAGE C. D. (hydraulic), 205 East Main (See page 694)
 WRAY HENRY & SON, 109 Mill (See page 672)

War Flower Materials.

HUNTINGTON M. & E. 36 E. Main (See front colored page)

Well Diggers.

Fickett Frank, 174 Exchange
 Hill A. R. & Son, Summer
 Schneider Joseph, 11 Cole
 SHERRY G. E. 17 St. Joseph (See p. 643)

Wheel Manufs.

CORRIS WM. & CO., Hill c. Elizabeth
 (See page 607)
 Wilson J. H. 3 Aqueduct

Whip Dealers.

Winn A. 23 Exchange

Whip Manufs.

Holton A. L. 102½ East Main
 STRONG & WOODBURY, Allen c.
 N. Washington (See page 669)

Whip Mountings.

Ellis E. E. 48 Scio

White Washers.

Anderson Henry, 82 Tremont
 Andrews John, r. 24 Favor
 Thomas Wm. 21 Madison

Wig and Toupee Maker.

WACKERMAN M. 90 State (See p. 515)

Window Shades.

MILLER E. T. 9 W. Main (See p. 623)

Wines.

See also *Liquors, Wines, &c.*

BECK GEORGE (*native*), at Charlotte
 (See page 580)
 BRYANT J. P. (*Rhus*), 150 Powers' bldgs. (See front colored page)
 Dubelbeis Charles W., Bay c. North av.
 HOWARD J. O. 114 State (See p. 563)
 MOGRIDGE JOHN, Spring c. Plymouth av. (See page 575)
 ROSENTHAL GUSTAV, 107 North avenue (See page 562)
 SAYER JOSEPH, 132 West Main (See page 561)

Wire Work.

HADDETON JOSEPH, 89 State
 (See page 609)
 Wall Edward, 194 E. Main
 White R. C. 121 State

Wood Dealers.

BAILEY W. S., Alexander st. Bridge
 (See page 599)
 Barber A. D. & Son, 10 Spring
 Batterson Geo. ft. North Water
 Britton A. P. 153 S. St. Paul
 DANFORD A. & SON, ft. N. Water
 (See page 558)
 Demmer E. 2 Edwards
 Hall August, 6 Cobb
 Heisinger J. r. 255 North Clinton
 HILL & FRENCH, 33 West av. (See page 601)

KNAPP & FISHER, 99 N. St. Paul
 opp. Ward, and 25 Pinnacle av.
 (See page 598)
 Messurier E. L. 100 Mt. Hope av.
 Miller Peter, 108 North av.
 PALMER N. L. & SON, 83 Allen (See page 598)
 Siefert Michael, 115 North av.
 Whitbeck & Dobbs, 205 E. Main
 Whitlock G. L. 225 N. Clinton
 Williams A. 61 S. Union
 Young Alfred, 45 Monroe avenue

Wood Engravers.

EVENING EXPRESS PRINTING AND ENGRAVING CO. 23 W. Main (See opp. page 528)
 FRAUENBERGER GEO. 59 Arcade (See page 517)
 LOCKHART & LEADLEY, 24 E. Main (See page 577)

Wood Tool Manufs.

CONNELL & DENGLER, Mill cor. Furnace (See opp. page 551)
 GRAHAM J. S. & CO., Mill n. Factory (See page 672)
 GREENWOOD JOHN & CO., Mill n. Furnace (See page 688)
 TOMPKINS C. R. & CO., Mill corner Factory (See page 673)
 ZIEGLER L. & CO. foot North Water n. railroad (See page 673)

Wood Working Machines.

LEE H. A., Worcester, (See page 586)

Wooden Box Manufs.

STEVENS J. B. & SON, ft. Centre (See page 535)

Wooden Limbs.

DAWES JOSEPH, 170 West avenue (See page 587)

Wool and Pelts.

Castleman Frank, 14 North Water
 Hollowell & Willis, 39 N. Water
 Lowrey & Bradner, 23 N. Water
 Smith John, 13 North Water

Woolen Yarns.

LOWENTHAL & ETTENHEIMER, 10 Mumford (See page 544)

Wrinding Machines.

Curtis Geo. G. 131 N. Water
 Lundy D. S., West av. cor. Wentworth
 PHELPS E. S. & Co. 4 East Main (See page 618)

Yachts.

DOYLE JOSEPH, Charlotte (See page 598)

Yeast Manufs.

GAFF, FLEISCHMANN & CO 156 E. Main (See page 558)

HENRY C. WISNER,

**REAL AND FRENCH BRONZES,
 No. 33 STATE STREET.**

MUNICIPAL
ELECTION
FIRST TUESDAY
AFTER THE
FIRST MONDAY
OF MARCH



CITY
GOVERNMENT
ORGANIZED
FIRST
MONDAY
OF APRIL.

MEETINGS OF THE COMMON COUNCIL ON ALTERNATE TUESDAYS.

CITY GOVERNMENT FOR 1876.

Office Hours, 9 A. M. to 3 P. M.

Mayor.—CORNELIUS R. PARSONS. *Elected biennially. Term exp. April, 1878.*

SALARY \$2,500; OFFICE, CITY HALL; *Office Hours, 10 to 12 A. M.*

COMMON COUNCIL.

President.....JOHN W. MARTIN

Terms Expire April, 1877.

Ward 1.	GEORGE W. ALDRIDGE.	WILLIAM H. TRACY.
" 2.	ANDREW NAGLE.	JOHN M. BROWN.
" 3.	DAVID H. WESTBURY.	THOMAS PEART.
" 4.	ALONZO G. WHITCOMB.	NATHAN PALMER.
" 5.	HENRY BRINKER.	FREDERICK MORHARDT.
" 6.	SIMON HAYS.	WILLIS C. HADLEY.
" 7.	FRANCIS S. HUNN.	GEORGE A. REDMAN.
" 8.	JOHN W. MARTIN.	ALONZO H. BENNETT.
" 9.	JAMES H. KELLY.	EMORY B. CHACE.
" 10.	EDWIN HUNTINGTON.	WALTER WELDON.
" 11.	GEORGE FLECKENSTEIN.	JOHN BRAYER.
" 12.	JOHN MCGRAW, 2ND.	BENJAMIN F. THOMAS.
" 13.	JACOB NUNNOLD.	FREDERICK C. LAUER, jr.
" 14.	WILLIAM S. SMITH.	LOUIS P. BECK.
" 15.	ANTHONY H. MARTIN.	JOACHIM P. RICKARD.
" 16.	J. GEORGE BAETZEL.	GEORGE HILBERT.

STANDING COMMITTEES.

Appointed by the President.

Finance.—Kelly, Hays, Fleckenstein, Baetzel, Beck.

Law.—Hays, Huntington, McGraw, A. H. Martin, Smith.

Contingent.—Chace, Whitcomb, Hilbert, Weldon, Westbury.

Streets and Bridges.—Aldridge, Peart, Beck, Brown, Hadley.

Public Improvements.—Whitcomb, Kelly, Aldridge, Beck, Weldon.

Sewers.—Baetzel, Lauer, Bennett, Rodman, McGraw.

Support and Relief of Poor.—Fleckenstein, Hadley, Nunnold, Tracy, Palmer.

Opening and Alteration of Streets.—Hil-

A. R. PRITCHARD & LIKLY, FINE MOROCCO SATCHELS,
No. 78 STATE STREET.

- bert, Peart, Brayer, Westbury, Hadley.
- Fire Department.*—Tracy, Whitcomb, Beck, Nunnold, Rickard.
- Public Lamps.*—Brinker, A. H. Martin, Chace, Thomas, Huntington.
- Public Parks.*—Rickard, Kelly, Bennett, Brown, Redman.
- City Property.*—A. H. Martin, Tracy, Nunnold, Hunn, Rickard.
- Police.*—Hadley, Hilbert, Brayer, Aldridge, Palmer.
- Schools.*—Weldon, Hunn, A. H. Martin, Morhardt, Nagle.
- Markets.*—Peart, Bennett, Hilbert, Nagle, Westbury.
- Wooden Buildings.*—Beck, Brinker, Smith, Redman, Hunn.
- Sprinkling Streets.*—Nagle, Fleckenstein, Aldridge, Rickard, Brinker.
- Ordinances and Rules.*—Westbury, Thomas, McGraw, Lauer, Brayer.
- Grievances.*—Brown, Baetzel, Hunn, Brinker, Chace.
- Charter Amendments.*—Hays, Brinker, Chace, Redman, Fleckenstein.
- Reservoir and Water Works.*—Lauer, Kelly, Fleckenstein, Weldon, Brown.
- House for Idle and Truant Children.*—Bennett, Baetzel, Brown, Morhardt, Lauer.
- Assessments.*—Thomas, Peart, A. H. Martin, Brayer, Lauer.
- Surveys and Records.*—Smith, Bennett, Tracy, Redman, Palmer.
- Hackney Couches.*—Palmer, Whitcomb, Rickard, Aldridge, Thomas.
- Excise.*—Rickard, Hilbert, Morhardt, Nagle, Peart.
- Mount Hope.*—Brayer, Hays, Fleckenstein, Hadley, Nunnold.
- Public Health.*—McGraw, Brown, Nunnold, Weldon, Beck.
- City Clerk.*—Edward Angevine; salary \$1,800; appointed biennially by the Common Council; term expires April, 1878. *Assistant*—Peter E. Sheridan, salary \$900; appointed by Committee on Finance.
- Messenger.*—Francis J. Irwin; salary \$1,000; appointed annually by the Common Council.
- City Treasurer.*—George D. Williams; salary \$4,000; elected biennially by the people; term expires April, 1878. *Assistants*—E. W. Williams, salary \$1,500; Chas. H. Stilwell, salary \$1,200; Warham Whitney, salary \$600; appointed by Committee on Finance.
- City Surveyor.*—Oscar H. Peacock; salary \$2,500; appointed biennially by the Common Council; term expires April, 1878. *Assistants*—John C. Ryan, salary \$1,200; Wm. S. Smith, salary \$1,200; Chas. B. Parsons, salary \$1,200; Wm. J. Stewart, salary \$600; Ambrose Redman, salary \$300; appointed by Survey and Record Committee.
- City Attorney.*—J. Breck Perkins; salary \$2,000; office 18 Powers' buildings; appointed biennially by the Common Council; term expires May, 1878.
- Overseer of the Poor.*—Joseph Schutte; salary \$1,500; office 61 Front street; appointed biennially by the Common Council; term expires April, 1878. *Assistants*—John T. Tracy, salary \$1,000; Wm. H. Shields, salary \$1,000; Louis Wehn, salary \$540; appointed by Committee on Support and Relief of Poor.
- Cattle Police.*—James H. Moore, Patrick Kane, William H. Thompson, Henry McMahon; salary \$600; appointed by Mayor.
- Sealer of Weights and Measures.*—Cornelius McDonald; salary, fees; appointed annually by the Common Council.
- Watchman City Hall.*—John E. McDermott; salary \$900; appointed by Committee on City Property.
- Engineer City Hall.*—John Cullinan; salary \$900; appointed by Committee on City Property.
- Janitor Front Street Building.*—Peter E. Miller; salary \$600; appointed by Committee on City Property.

WATER WORKS COMMISSION.

Expires by limitation Oct. 1, 1876—Office City Hall.

Appointed by the Mayor—Salary \$5 per diem for actual service.

Commissioners—Roswell Hart, Charles C. Morse, Maurice H. Merriman, Gilman H. Perkins, James C. Cochrane.

COMMISSIONERS OF EXCISE.

Office City Hall. Salary \$1,000.

James Baker, Herman Mutschler, Edward B. Fenner.

Appointed by the Mayor for three years. Terms expire 1879.

HENRY C. WISNER,

PARIAN BUSTS AND FIGURES,
No. 33 STATE STREET.

ASSESSORS' DEPARTMENT.

Office, City Hall. Appointed by the Common Council. Salary \$1,800.

David McKay, term expires Jan. 1877. Ebenezer T. Oatley, term expires Jan. 1878. August M. Koeth, term expires Jan. 1879. *Assistant*—John M. Bardwell; salary \$1,500; appointed by Committee on Assessments.

POLICE DEPARTMENT.

Police Station, at City Hall.

Commissioners.—The Mayor, *ex-officio*; Frederick Zimmer, term expires April, 1877; George G. Cooper, holds over, term expired April, 1875; salary \$1,000; appointed by the Common Council every four years; regular meetings for public business every Thursday afternoon.

Police Justice.—Albert G. Wheeler; salary \$3,000, fixed by the Common Council; elected by the people every four years; term expires April, 1877.

Clerk of Commissioners and Police Court.—B. Frank Enos; salary \$1,500; appointed by the Police Commissioners.

Chief of Police.—Alexander McLean; salary, \$1,700; appointed by the Police Commissioners.

Captain.—P. H. Sullivan. Salary, \$1,320.

There are eighty-four policemen, including eight detectives, and two roundsmen, appointed annually in July by the Police Commissioners; about twenty being on duty during the day, and the remainder at night. Salary \$75 per month, fixed by the Commissioners; salary of detectives and roundsmen, \$85.00.

CONSTABLES.

Elected Annually in March.

WARD 1—Lyman Johnson.	WARD 9—Jonathan Reynolds.
“ 2—A. H. Waterman.	“ 10—William S. Brown.
“ 3—Lewis K. Churchill.	“ 11—George M. Eggleston.
“ 4—John N. Forbes.	“ 12—John Dart.
“ 5—Isaac V. Moshier.	“ 13—William R. Maurer.
“ 6—Paul Engelhardt.	“ 14—John Simpson.
“ 7—William L. Jordan.	“ 15—Hiram Rogers.
“ 8—James McMullen.	“ 16—John Barrett.

Game Constable.—William S. Brown.

INSPECTORS OF ELECTION.

Elected Annually.

WARD 1—Darrell D. Sully, Alexander J. Pope.
“ 2—George F. Lenihan, James Burke.
“ 3— { 1st Dist.—William Tanner, Geo. H. Lucas, John F. Holmes.
“ 3— { 2d Dist.—Frank N. Bottum, Thomas McMillan.
“ 4—W. V. K. Lansing, Wm. H. St. John.
“ 5— { 1st Dist.—M. K. Gannon, Chauncy Duxtater, Jacob N. Kolb.
“ 5— { 2d Dist.—Geo. H. Truex, Joseph P. Cox, James E. Ryan, jr.
“ 6—Julius Newhafer, Henry Levy.
“ 7—William I. Hanford, Milton Noyce, Jones Fowler.
“ 8— { 1st Dist.—Robert DeGarmo, Geo. P. Bortle.
“ 8— { 2d Dist.—M. J. Mulryan, Jas. H. Laverty, Fred. C. Whittlesey.
“ 9— { 1st Dist.—Charles J. Robinson, Patrick A. Moran.
“ 9— { 2d Dist.—Eli Leavenworth, Carl A. Servoss.
“ 10—Asa A. Jayne, John E. Carbury, Chas. Newton.
“ 11—William Wolf, August Drees.
“ 12—Roswell Woodward, William Hulbert, Alexander B. Patten.
“ 13—Florian A. Hettig, Henry S. Elinger.
“ 14—Thos. Gosnell, John R. Strauchen.
“ 15—James Dalton, Albert Bosche.
“ 16— { 1st Dist.—James W. Stanley.
“ 16— { 2d Dist.—Geo. Handel, jr., Charles Spaar.
“ 16— { 3d Dist.—Valentine Laforce, Jacob Baetzal.

CEMETERIES.

HOLY SEPULCHRE CEMETERY. Incorporated April 24, 1872. Located on Lake avenue, in the town of Greece. It is under the management of a Board of Trustees, composed of the Bishop of the Diocese, four priests and ten laymen. Number of interments during the year ending May 31st, 1876, 718. Total number of interments, 2,838.

Superintendent—Pierre Meisch.

Clerk—Thomas McGovern, office 34 Platt.

Treasurer.—P. Mahon.

ST. BONIFACE'S CEMETRY, Cayuga street.

MOUNT HOPE CEMETERY, located in the south part of the city, overlooking the Genesee River. It contains 200 acres, and was purchased by the city in 1836. Number of interments during the year ending March, 1876, 1,364. Total number of interments May 31, 1876, 26,977.

Superintendent.—George D. Stillson—appointed by the Commissioners.

Commissioners.—Newell A. Stone, term expires May, 1877. James H. Kelly, term expires May, 1879. Willam S. Smith, term expires May, 1878.

ST. PATRICK'S CEMETERY (*Roman Catholic*), located in the south-eastern part of the city, on the western slope of what is known as Pinnacle Hill.

ST. PETER'S AND PAUL'S CEMETERY, Maple street.

PUBLIC CHARITABLE INSTITUTIONS.

SEE ALSO SOCIETIES.

HOUSE FOR IDLE AND TRUANT CHILDREN. Incorporated 1854. No. 263 N. St. Paul street. *Managers*—C. C. Meyer, D. M. Anthony, Geo. Herzberger, A. H. Cushman, Francis N. Skuse, M. H. Green, De L. Crittenden, Moses Hays, F. H. Smith. *Pres't.*, Geo. Herzberger; *Sec'y.*, A. H. Cushman; *Supt't.*, E. W. Bryan. Appointed by Common Council. Meetings first Thursday in each month. Annual meeting in December.

ROCHESTER CITY HOSPITAL, No. 93 West avenue. *Pres't.*, Aaron Erickson; *Vice-Pres't.*, Levi A. Ward; *Sec'y.*, James L. Angle; *Treas.* E. S. Ettenheimer; *Executive Committee*, L. A. Ward, Samuel Wilder, C. C. Morse; *Visiting Physicians*, David Little, W. S. Ely, E. V. Stoddard; *Surgeons*, H. F. Montgomery, H. H. Langworthy, J. F. Whitbeck; *Female Department*, H. W. Dean; *Oculist*, C. E. Rider; *House Physician in charge*, Charles Carey; *Matron*, Miss Frances E. Hebbard.

ST. MARY'S HOSPITAL, West avenue corner Genesee street. Under direction of Sisters of Charity.

WESTERN HOUSE OF REFUGE. Incorporated 1846. Located on Phelps avenue. *Pres't.*, George J. Whitney, *Vice-Pres'ts.* Charles H. Monell, Mortimer F. Reynolds; *Sec. and Treas.* W. C. Rowley. Annual meeting third Tuesday in March.

OFFICERS OF THE HOUSE.—*Superintendent*, Levi S. Fulton; *Assistant Supt.*, Francis A. Baker.

SCHOOLS.—*First Division: Principal*, Robert Fulton; *Assistants*, Eliza J. Alley, Addie L. Fulton; *S. S. Teacher*, Mrs. S. J. Nichols. *Second Division: Principal*, William H. Whiting; *Assistants*, R. Maria Alleyn, Mary Gilman, Anna Thomas. *Primary Department*—*First Division: Principal*, Anna M. Hollenbeck. *Physician*, A. Backus. *Chaplains*, W. Manning, Geo. J. Osborne.

PRINTING AND ADVERTISING.

City Printers.—Rochester Printing Co., Curtis, Morey & Co.; Evening Express Printing Co., contract each at \$3,000 per annum. A. Nolte; L. W. Brandt; contract at \$2,000. George Feuchtinger; Daniels & Phillips, \$1,000.

LAMPS.

There are 2,160 gas lamps; of this number 1,150 are on the east side of the river, and are supplied with gas by the Citizen's Gas Company at the rate of \$28.65 per annum for each lamp; 1,010 are on the west side, and are supplied with gas by the Rochester Gas Light Company at the rate of \$28.65 per annum, care and lighting included.

There are also 1,724 oil lamps, supplied with kerosene oil, lighted and cared for by Charles J. Jeffords, at the rate of \$8.49 for each lamp, care and lighting included.

CHURCHES.

CHURCHES.

FOUN- DED.	NAME OF CHURCH.	LOCATION.	DENOMINATION.	PASTOR.	SECT- TURED.	S. S. SUPERINTEND'T	SEXTON.
1818	First Baptist Church.....	Fitzhugh Street.....	Baptist.....	Charles J. Baldwin.....	1874	Austin H. Cole.....	James Naylor.
1834	Second Baptist Church.....	North cor. Franklin.....	Baptist.....	T. Edwin Brown.....	1869	George W. Rawson.....	Amos Wheeler.
1851	German Baptist Church.....	Andrews Street.....	Baptist.....	Peter Ritter.....	1875	George Fischer.....	G. Guenter.
1871	East Avenue Baptist Church.....	East Avenue cor. Anson park.....	Baptist.....	Henry L. Morehouse.....	1873	Solomon G. Phillips.....	John A. Wilferth.
1871	Lake Av. Memo. Baptist Church.....	Lake Avenue cor. Ambrose.....	Baptist.....	Ebenezer Nisbet.....	1871	E. Nisbet.....	Samuel Cook.
1860	Christadelphians.....	Palmer's Block, 138 E. Main St.....	Christadelphian.....
1851	Plymouth Congregational Society.....	Plymouth Avenue cor. Troup.....	Cong. (Trinita'n).....	Myron Adams.....	1876	Sidney A. Newman.....	Jacob Hyne.
1841	First Unitarian Cong. Society.....	Fitzhugh Street.....	Cong. (Unitarian).....	Newton M. Mann.....	1870	James L. Angle.....	A. H. Bruman.
1817	St. Luke's Church.....	Fitzhugh Street.....	Episcopal.....	{ Henry Anstice, Rector..... { Wm. Long, Assistant.....	1866	Henry Anstice.....	J. P. Kisingbury.
1833	St. Paul's Church.....	North St. Paul near E. Main.....	Episcopal.....	{ Israel Foote, Rector..... { Benj. T. Hall, Assistant.....	1859 1875	Israel Foote.....	George Years.
1845	Trinity Church.....	Frank corner Centre.....	Episcopal.....	Warren W. Walsh, Rector.....	1875	Warren W. Walsh.....	Charles Seymour.
1855	Christ Church.....	East Avenue near William.....	Episcopal.....	Joseph L. Tucker, Rector.....	1875	Frank Ward.....	J. W. Armstrong.
1866	St. Clement's Church (Free).....	Munger corner Ashland.....	Episcopal.....	David A. Bonnar, Rector.....	1874	David A. Bonnar.....	Thomas A. Evans
1869	Church of the Good Shepherd.....	Grape Street.....	Episcopal.....	B. W. Stone, Rector.....	1873	Geo. H. Cummings.....	T. H. Thompson.
1869	Church of Epiphany.....	South Frances opp. Adams.....	Episcopal.....	Chas. M. Nickerson Rector.....	1876	Edward Hart.....	Mark Martin.
1875	St. John's Chapel.....	State Street, (Cochrane block).....	Episcopal.....	John J. Landers.....	1875	John J. Landers.....
1842	German United Evang. Trinity Ch.....	Allen Street near Fitzhugh.....	Evangelical Ass'n.....	Bernard Pick.....	1874	John T. Cook.....	J. Geib.
1847	First Ch. Evan. Ass'n (German).....	St. Joseph cor. Nassau.....	Evangelical Ass'n.....	Albert Unholz.....	1875	George Fisher.....	G. Jaeger.
1862	Ger. United Evang. St. Paul's Ch.....	Fitzhugh Street.....	Evangelical Ass'n.....	August Grotrian.....	1873	Christian F. Frank.....	Jacob Lutz.
1874	German Evang. Salem's Church.....	Franklin Street n. N. St. Paul.....	Evangelical Ass'n.....	Charles Siebenpfeiffer.....	1874	Thomas Dransfield.....	John Bless.
1817	Friends' Meeting House.....	Hubbell Park.....	Friends (Hicksite).....
1828	Friends' Meeting House.....	Alexander Street.....	Friends (Ortho.).....	Jacob D. Bell.....	1862	Alex. M. Purdy.....	Barnet B. Flagler.
1843	Berith Kodesh Congregation.....	North St. Paul near Andrews.....	Hebrew.....	Max Landsberg.....	1871	S. Wile.....	J. H. Levi.
1870	Congregation Aitz Raanon.....	St. Joseph Street.....	Hebrew.....	V. Rundbaken.....	1870	V. Rundbaken.....	— Rothschild
1834	Zion's First German Luth. Church.....	Grove cor. Stillson.....	Lutheran.....	C. F. W. Hoppe.....	1874	C. F. W. Hoppe.....	Jost Marburger.
1869	Church of the Reformation.....	Grove near North.....	Lutheran, English.....	Charles S. Kohler.....	1874	William Arnold.....	Jacob Hoehn.
1820	First Meth. Epis. Church.....	Fitzhugh Street.....	Meth. Episcopal.....	Robert M. Stratton.....	1875	James Vick.....	Henry A. Cory.
1837	Zion Church.....	Favor near Spring.....	Meth. Episcopal.....	Jackson W. Lacey.....	1875	John W. Goss.....	John Andrews.
1849	German Meth. Episcopal Church.....	North Street near Hudson.....	Meth. Episcopal.....	J. F. Seidel.....	1873	Fred. Koehler.....
1850	North Street Meth. Epis. Church.....	North street opp. Ontario.....	Meth. Episcopal.....	E. Lansing Newman.....	1875	G. P. Davis.....	W. H. Brown.

HENRY C. WISNER,

DECORATED CHINA, SILVER SETS,
No. 33 STATE STREET.

1852	Frank Street Meth. Epis. Church.	Frank cor. Smith.	Meth. Episcopal.	Thomas E. Bell.	1874	William Cochran.	Franklin Johns.
1853	Cornhill Meth. Epis. Church.	Edinburgh Street.	Meth. Episcopal.	Albert D. Wilbor.	1873	N. L. Button.	James Cook.
1853	Alexander St. Meth. Epis. Church.	Alexander Street.	Meth. Episcopal.	Thomas J. Leak.	1875	Elias E. Hale.	A. St. John.
1860	Asbury Meth. Epis. Church.	E. Main cor. S. Clinton.	Meth. Episcopal.	Charles Eddy.	1874	A. Mandeville.	John S. Miller.
1860	Free Methodist Church.	Atwater Street cor. Leopold.	Methodist (Free).	Walter A. Sellow.	1875	Frank Mallory.	E. Benedict.
1815	First Presbyterian Church.	Plymouth Av. cor. Spring.	Presbyterian.	James L. Robertson.	1870	George C. Buell.	John Babbage.
1825	Brick Church.	Fitzhugh cor. Allen.	Presbyterian.	James B. Shaw.	1840	Charles Weaver.	A. B. McConnell.
1827	Third Presbyterian Church.	Temple Street.	Presbyterian.	George Patton.	1872	Sardius D. Bentley.	Daniel Gerhard.
1836	Central Presbyterian Church.	Sophia near West Main.	Presbyterian.	Samuel M. Campbell.	1866	J. Horace McGuire.	J. G. Lightfoot.
1853	St. Peter's Church.	Gibbs cor. Grove.	Presbyterian.	Herman S. Riggs.	1876	J. E. Pierpont.	George Odell.
1856	Calvary Church.	South Av. cor. Hamilton place.	Presbyterian.	Herbert W. Morris.	1867	F. S. Stebbins.	Henry R. Granger.
1868	Westminster Church.	West Av. near N. Frances.	Presbyterian.	Corlis B. Gardner.	1875	Edmund M. Doane.	Wm. Ernsshaw.
1870	Memorial Church.	Hudson cor. Wilson.	Presbyterian.	Charles P. Coit.	1875	L. G. Wetmore.	
1840	Reformed Presbyterian Church.	North St. Paul near Andrews.	Pres. Reformed.	R. D. Sproull.	1864	Abraham Ernisse.	W. Ernisse.
1848	First Reformed Church.	Oregon cor. Harrison.	Ref. Ch. in Amer.	Peter De Bruyn.	1873	John Van Doorn.	Peter Plasse.
1852	Evan. Reformed Emanuel Church.	Hamilton Place.	Reform'd C'h, U.S.	Henry C. Heyser.	1874	John Miller.	Peter Wiegant.
1848	United Presbyterian Church.	Allen near Fitzhugh.	United Presbyt'n.	J. P. Sankey.	1864	J. P. Sankey.	Robert St. Clair.
1820	St. Patrick's Cathedral.	Platt cor. Frank.	Roman Catholic.	Bernard J. McQuaid.	1868		
				Bishop of the Diocese.			
				Jas. F. O'Hare, Rector.	1876	P. Mahon.	Thos. McGovern.
				H. De Regge, Chancellor.			
				Geo. Osborne, Assistant.			
1842	St. Mary's Church.	South near Court.	Roman Catholic.	John P. Stewart.	1871	Sisters of Mercy.	Robert Jones.
1843	St. Peter and Paul's Church.	E. Maple cor. King.	Roman Catholic.	T. Rosseter.	1875	F. H. Sinclair.	P. Voltz.
				Francis H. Sinclair.	1865		
				Thaddeus Anwander.	1874		
1846	St. Joseph's Church (German).	Franklin near Andrews.	Roman Catholic.	Lawrence Hoeltzer.	1875	Brother Louis.	Bonavantura.
				Stephen Schneider.	1874		
				Peter Frischbier.	1875		
1848	Our Lady of Victory's (French).	Pleasant Street.	Roman Catholic.	Joseph Dole.	1849		
1848	Church Immaculate Conception.	Plymouth Av. near Glasgow.	Roman Catholic.	Martin M. Meagher.	1875	James H. Lafferty.	Robert Brennan.
1854	St. Bridget's Church.	Hand Street.	Roman Catholic.	James O'Connor.	1876	J. C. Hughes.	John Reiter.
1861	St. Boniface's Church (German).	Grand Street.	Roman Catholic.	Herman Renker.	1865		
1864	Church of the Holy Family.	Jay Street.	Roman Catholic.	Leopold Hofschneider.	1867	L. Hofschneider.	
1866	Holy Redeemer Church.	Hudson cor. Clifford.	Roman Catholic.	Fidelis Oberholzer.	1869	Fidelis Oberholzer.	
1874	St. Michael's Church.	N. Clinton corner Clifford.	Roman Catholic.	Fridolin Pascalar.	1874	Fridolin Pascalar.	
1867	Advent Christian Church.	24 East Main.	Second Adventist.	Edwin F. Sergisson.		George E. Waugh.	Ghas. Glover.
1846	First Universalist Church.	South Clinton near E. Main.	Universalist.	Asa Saxe.	1860	W. Edgar Cook.	

PUBLIC SCHOOLS.

BOARD OF EDUCATION.

Office and Library, Free Academy Building, Fitzhugh street.

President of the Board.....MICHAEL H. FITZSIMONS.

COMMISSIONERS.

Terms expire April, 1878.

WARD 1.—HENRY BEMIS.
 “ 3.—HENRY WRAY, JR.
 “ 5.—GEO. H. NEWELL.
 “ 7.—WM. R. CAULKINS.
 “ 9.—FAY E. BROWNELL.
 “ 12.—V. F. WHITMORE.
 “ 13.—W. G. MARTENS.

Terms expire April, 1877.

WARD 2.—MICHAEL H. FITZSIMONS.
 “ 4.—HAMILTON H. HOWARD.
 “ 6.—JOHN E. RELYEA.
 “ 8.—ROBERT T. LESTER.
 “ 10.—HENRY M. PLANT.
 “ 11.—LUKE R. FLYNN.
 “ 14.—GEORGE P. DAVIS.
 “ 15.—NICHOLAS L. BRAYER.
 “ 16.—JACOB J. HART.

Superintendent and Librarian.—CHARLES N. SIMMONS; salary \$1,800. Appointed by the Commissioners.

Assistant Librarian.—MRS. S. M. DRANSFIELD; salary \$600. Appointed by the Commissioners.

Messenger of the Board.—FREDERICK S. JONES; salary \$300. Appointed by the Commissioners.

STANDING COMMITTEES.

Finance.—FLYNN, HART, DAVIS, WHITMORE and BROWNELL.

Qualification and Employment of Teachers.—NEWELL, LESTER, FLYNN, WRAY and RELYEA.

Examination and Organization of Schools, and Grievances.—PLANT, BRAYER, DAVIS, LESTER and CAULKINS.

Text Books, Library and Apparatus.—HART, NEWELL, BRAYER, WRAY and FLYNN.

Buildings and Repairs.—WHITMORE, FLYNN, BEMIS, BROWNELL and HOWARD.

Supplies.—RELYEA, PLANT, WRAY, WHITMORE and HART.

Fuel and Fire Pictures.—BEMIS, DAVIS, WHITMORE, MARTENS and RELYEA.

Printing.—BRAYER, CAULKINS, PLANT, NEWELL and MARTENS.

Free Academy.—LESTER, FLYNN, HOWARD, BEMIS and WRAY.

Law.—BRAYER, BROWNELL, MARTENS, CAULKINS and BEMIS.

SALARIES OF TEACHERS.

Grammar and Intermediate.—Male Principals, \$1,500. Female Principals, \$700. Numbers 7 and 18, \$1,000 and \$1,250. Assistants, from \$350 to \$500.

NUMBER OF PUPILS.

Number pupils registered in public schools, 11,213. Average number belonging, 7,446.

CENSUS OF SCHOOL CHILDREN BETWEEN 5 AND 21 YEARS OF AGE.

In 1875—East Side, 19,317; West Side, 17,215.

In 1874—East Side, 18,280; West Side, 15,507.

In 1873—East Side, 13,836; West Side, 13,232.

In 1872—East Side, 15,497; West Side, 13,724.

PUBLIC SCHOOL TEACHERS.

Rochester Free Academy.—Fitzhugh street near West Main. *Principal*, Nehemiah W. Benedict, salary, \$1,800; *Assistant Principal*, J. M. Wells, salary, \$1,800; *Preceptress*, Martha E. Gaylord, salary, \$1,000; *Assistants*, C. R. Wilkinson, salary, \$700; L. R. Pope, salary, \$600; Helen B. Case, salary, \$800; F. E. Glen, salary, \$1,000; *Teacher of German*, A. Trzeciak, salary, \$1,000; *Teacher of Natural Sciences and Drawing*, Charles Forbes, salary, \$1,200. Number of pupils, 321.

A. R. PRITCHARD & LIKLY, TRAVELERS' GOODS, ALL KINDS,
 No. 78 STATE STREET.

- No. 2. INTERMEDIATE.**—King street. *Principal*, M. S. Anthony; *5th Grade*, I. M. Banta; *6th Grade*, H. A. Merriam; *7th Grade*, Clara C. Lathrop; *8th grade*, R. G. Bolles; *9th Grade*, M. E. Bassett. Number of pupils, 241.
- No. 3. GRAMMAR SCHOOL.**—Tremont street. *Principal*, James M. Cook; *2d Grade*, M. A. Sterling; *3d Grade*, M. F. Richmond; *4th Grade*, G. A. Badger; *5th Grade*, M. J. Dickson; *6th Grade*, J. L. Cowles; *7th Grade*, F. E. Galloway; *8th Grade*, J. E. Gilson; *9th Grade*, A. M. Stewart. Number of pupils, 452.
- No. 4. GRAMMAR SCHOOL.**—Frances street. *Principal*, S. C. Pierce; *2d Grade*, Mary E. Gilman; *3d Grade*, E. Della Brown; *4th Grade*, Emma A. C. Hayes; *5th Grade*, Frank A. C. Reichenbach, E. S. Baker; *6th Grade*, Eliza A. Woodbury; *7th Grade*, Louisa J. Connell; *8th Grade*, M. H. Bennett; *9th Grade*, Julia G. Lyndon, Amelia L. Leahy; *Assistant*, Ella I. Munson. Number of pupils, 501.
- No. 5. GRAMMAR SCHOOL.**—Centre street corner Jones. *Principal*, W. E. Cook; *2d Grade*, S. C. O'Keefe; *3d Grade*, A. L. Brettell; *4th Grade*, N. C. Lathrop; *5th Grade*, F. V. Wright; *6th Grade*, E. P. Wetmore; *7th Grade*, L. M. Qualtrough; *8th Grade*, Eliza Freeland; *9th Grade*, E. Horn. Number of pupils, 333.
- No. 6. GRAMMAR SCHOOL.**—Lyell street corner Frank. *Principal*, Julius L. Townsend; *2d Grade*, Mary E. DePoe; *3d Grade*, Ella L. Carr, Dora E. Clark; *4th Grade*, Martha A. Clackner; *5th Grade*, May Marsh; *6th Grade*, Libbie I. Brown; *7th Grade*, L. M. Kane, Carrie E. Servoss; *8th Grade*, Libbie J. Brown, *9th Grade*, M. O. Brown, E. S. Alleyn. Number of pupils, 465.
- No. 7. GRAMMAR SCHOOL.**—Lake avenue. *Principal*, Delia Curtice; *2d Grade*, Lois Hanford; *3d and 4th Grades*, Ella Norris; *5th and 6th Grades*, Emma Bell; *7th and 8th Grades*, Sarah L. Delano; *9th Grade*, Emma Marsh. Number of pupils, 167.
- No. 8. GRAMMAR SCHOOL.**—North St. Paul near Tower street. *Principal*, Nellie A. Conkey; *Assistant*, S. J. Curtiss. Number of pupils, 52.
- No. 9. GRAMMAR SCHOOL.**—St. Joseph street. *Principal*, W. H. Bosworth; *2d Grade*, Sarah J. Whalen; *3d Grade*, Fanny P. Elton; *4th Grade*, Alice A. Robinson; *5th Grade*, Jennie Madden, Delia C. Moser; *6th Grade*, Susan Havill; *7th Grade*, Emily J. Fenner, Rosa G. Goddard; *8th Grade*, E. T. Fitzgerald; *9th Grade*, Lucy A. Fitzgerald, Isabella Rogers, Katie A. Cunnean, Laura E. Leland. Number of pupils, 538.
- No. 10. GRAMMAR SCHOOL.**—North Clinton street. *Principal*, V. M. Colvin; *2d Grade*, A. M. Galbraith; *3d Grade*, M. J. Williams, E. J. Wallace; *4th Grade*, J. E. Burleigh; *5th Grade*, F. B. Gregory; *6th Grade*, H. A. Robinson; *7th Grade*, B. O'Rorke; *8th Grade*, E. E. Isles; *9th Grade*, J. A. Goggin. Number of pupils, 363.
- No. 11. INTERMEDIATE SCHOOL.**—Chestnut street, corner James. *Principal*, M. A. Hayden; *5th Grade*, Mary Purcell; *6th and 7th Grades*, Emma Remington; *8th and 9th Grades*, Jennie Crandall. Number of pupils, 148.
- No. 12. GRAMMAR SCHOOL.**—Wadsworth Square. *Principal*, N. C. Parshall; *Assistant*, Sarah T. Copeland; *2d Grade*, Anna H. Collins; *3d Grade*, D. Pierce; *4th Grade*, Mary Streeter; *5th Grade*, Alice C. Boyen; *6th Grade*, Ella V. Meyer; *7th Grade*, Helen C. Mudge; *8th Grade*, Jean Shaw; *9th Grade*, Jessie F. Booth. Number of pupils, 408.
- No. 13. GRAMMAR SCHOOL.**—Hickory street. *Principal*, A. G. Knapp; *2d Grade*, R. R. Short; *3d Grade*, L. Anne Randolph; *4th Grade*, M. C. Baker, P. H. Gordon; *5th Grade*, J. A. Morse; *6th Grade*, H. A. Morse; *7th Grade*, S. W. Howe, *assistant*, M. E. McLeod; *8th Grade*, S. S. McVicar; *assistant*, A. S. Glover; *9th Grade*, M. J. Lennon, Emma Perkins, L. F. Smith, Anna Page. Number of pupils, 575.
- No. 14. GRAMMAR SCHOOL.**—Scio street. *Principal*, John G. Allen; *2d Grade*, A. P. Thing; *3d Grade*, Emily Manvel, E. A. Phillips; *4th Grade*, E. T. Kinleyside; *5th Grade*, E. H. Duryee; *6th Grade*, D. Hannahs; *7th Grade*, F. M. Decker; *8th Grade*, E. L. Manvel; *9th Grade*, L. F. Perkins; *assistant*, E. R. Satterlee. Number of pupils, 452.
- No. 15. GRAMMAR SCHOOL.**—Monroe av. near Alexander street. *Principal*, J. W. Osburn, jr.; *2d Grade*, Emily Hanford; *3d Grade*, J. W. Gregg; *4th Grade*, C. McLearn; *5th Grade*, L. M. Reuter; *6th Grade*, U. Stilson; *7th Grade*, Livia A. Manvel; *8th Grade*, J. S. Bush; *9th Grade*, Katie A. Butler, D. B. Crouch. Number of pupils, 372.

No. 16. INTERMEDIATE SCHOOL.—North street. *Principal*, Lizzie A. McGonegal; *4th Grade*, Emma M. Moser; *5th Grade*, Anna M. Lowry; *6th Grade*, M. E. Biegler; *7th Grade*, Ella M. Patterson; *8th Grade*, Mary W. Lee; *9th Grade*, Frank H. Edgar. Number of pupils, 280.

No. 17. GRAMMAR SCHOOL.—Orange street. *Principal*, T. A. Raymond; *2d Grade*, M. J. McGorray; *3d Grade*, N. M. Monagan; *4th Grade*, M. E. Malone; *5th Grade*, F. A. Merriam; *6th Grade*, E. A. Redmond; *7th Grade*, S. L. Coghlin; *8th Grade*, C. R. Jennings; *9th Grade*, M. L. Foulds, Mary L. Coghlin. Number of pupils, 469.

No. 18. GRAMMAR SCHOOL.—North avenue. *Principal*, Sarah Shelton; *2d Grade*, M. W. Hinman; *3d Grade*, Ella E. Young; *4th Grade*, Alice J. Rundel; *5th Grade*, Alida J. Barron, Joanna H. Dickinson; *6th Grade*, Hattie L. Ball, E. Fannie Cowles; *7th Grade*, Nellie F. Cornell, Florence A. Waring; *8th Grade*, Delle S. Hanvey, Maggie Whitbeck; *9th Grade*, C. E. Pugh, A. J. Tomlin, Lucy H. Clark. Number of pupils 634.

No. 19. INTERMEDIATE SCHOOL.—Seward street corner Magnolia. *Principal*, M. E. Westfall; *5th and 6th Grades*, Mary A. Pierce; *7th and 8th Grades*, Emma M. Mathews; *9th Grade*, M. C. Bergh. Number of pupils, 173.

No. 20. INTERMEDIATE SCHOOL.—Oakman, near North Clinton. *Principal*, Louisa M. Daniels; *5th Grade*, Jane N. Brown; *6th Grade*, Helen A. Wedd; *7th Grade*, Nellie M. Allen; *8th Grade*, Sophia Samuels; *9th Grade*, Mary C Hogan, Eliza Rogers. Number of pupils, 287.

No. 21. Jay street. *Principal*, Elizabeth Kewin. Number of pupils, 79.

No. 22. Norton street. *Principal*, Amelia Stanley. Number of pupils, 48.

No. 23. Ely Place. *Principal*, E. Jewett. Number of pupils, 38.

PROTESTANT ORPHAN ASYLUM.—Hubbell park. *Principal*, C. E. Peirce; *Assistant*, Caroline M. Brown. Number of pupils, 80.

INDUSTRIAL SCHOOL.—76 Exchange. *Principal*, E. Stevens; *Assistant*, M. F. Dowling. Number of pupils, 79.

ST. PATRICK'S ORPHAN ASYLUM.—Frank, corner Vought. *Principal*, Aloysia Lee; *Assistant*, Mary de Sales. Number of pupils, 35.

ST. JOSEPH'S ORPHAN ASYLUM (GERMAN).—26 Franklin. *Principal*, Mary J. Climaca. Number of pupils, 62.

ST. MARY'S ORPHAN BOYS' ASYLUM.—West avenue, corner Genesee. *Principal*, Mary Leary; *Assistant*, Mary Delahunty. Number of pupils, 137.

UNIVERSITY OF ROCHESTER.—Prince street. *Officers of Board of Trustees*—President, JOHN B. TREVOR, of Yonkers; Vice-President, REV. EDWARD BRIGHT, D. D., of Yonkers; Chancellor, ————; Secretary and Treasurer, WILLIAM N. SAGE, of Rochester.

FACULTY.—President, Burbank Professor of Intellectual and Moral Philosophy, MARTIN B. ANDERSON, LL. D.; Munro Professor of the Greek Language and Literature, ASAHEL C. KENDRICK, D. D., LL. D.; Harris Professor of Mathematics and Natural Philosophy, ISAAC F. QUINBY, LL. D.; Professor of Chemistry, SAMUEL A. LATTIMORE, A. M.; Professor of Modern Languages, ALBERT H. MIXER, A. M.; Professor of Logic, Rhetoric and English Literature, JOSEPH H. GILMORE, A. M.; Professor of Mathematics, OTIS H. ROBINSON, A. M.; Professor of the Latin Language and Literature, WILLIAM C. MOREY, A. M.; Librarian, OTIS H. ROBINSON, A. M.; Curator of the Cabinets, SAMUEL A. LATTIMORE, Ph. D., LL. D.; Janitor, ELIJAH WITHELL.

ROCHESTER THEOLOGICAL SEMINARY.—*Officers of Board of Trustees*.—President, JACOB F. WYCKOFF, of New York; Vice-Pres., H. E. SMITH, of Fowlerville; Treasurer, CYRUS F. PAINE, of Rochester; Rec. Sec., AUSTIN H. COLE, of Rochester; Cor. Sec., ————; Ass't Cor. Sec., REV. S. ADSIT, of Rochester.

FACULTY.—President, Davies Professor of Biblical Theology, REV. AUGUSTUS H. STRONG, D. D.; Acting Trevor Professor of Biblical Literature and New Testament Exegesis, REV. ASAHEL C. KENDRICK; Pettigill Professor of Church History, REV. R. J. W. BUCKLAND, D. D.; Acting Professor of Church History, REV. HOWARD OSGOOD; Acting Professor of the Hebrew Language and Literature, REV. GEORGE H. WHITTEMORE; Wyckoff Professor of Homiletics and Pastoral Theology, REV. WILLIAM C. WILKINSON; Hoyt Professor, in the German Department, of Christian Theology and Church History, REV. AUGUSTUS RAUSCHENBUSCH; Professor, in the German department, of Biblical Literature and Rhetoric, REV. HERMANN SCHAFFER; Acting Librarian, REV. HOWARD OSGOOD.

A. R. PRITCHARD & LIKLY, SOLID RED CEDAR TRUNKS,
No. 78 STATE STREET.

Every Young Man

Whatever his other attainments, should have such a knowledge of business matters
as may be obtained in the

Rochester Business University

For Circulars, Address,

L. L. Williams.

President.

J. Rogers.

Secretary.

ROCHESTER REALSCHULE,
GERMAN-AMERICAN INSTITUTE,

7 and 9 Mortimer Street,

HERMANN PFAEFFLIN, Principal.

The principle on which the School is based requires a simultaneous study of the German and English languages. With this end in view, the Elementary classes in German and English will be combined, experience having proved, that thus a knowledge of both languages is most easily acquired. To facilitate the admission of older pupils, there will be a Special German Course, in which the English pupils will receive instruction apart, at the same time sharing with the rest the English lessons, presided over by competent American teachers.

Having acquired sufficient knowledge of German, these pupils will be incorporated with the German Classes.

For younger pupils there is established a "Kindergarten" Course. Children from four to seven are admitted.

Pupils not living in the city will be received as boarders on the most reasonable terms.

Applications will be received at the School, Nos. 7 and 9 Mortimer Street.

H. PFAEFFLIN,

Principal.

HENRY C. WISNER,

SUPERIOR ENGLISH CARVERS AND BEEF
SLICERS--No. 33 STATE STREET.

DAILY LINE TO C · A · N · A · D · A FROM ROCHESTER.

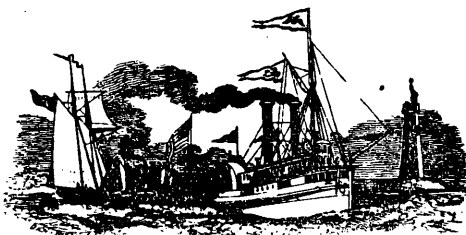

The SUPERB NEW LAKE UPPER STATE CABIN STEAMER

NORSEMAN,

Carrying United States and Canadian Mails and Express.

LEAVES CHARLOTTE,

Port of Rochester, every evening, at 9 o'clock, for COBOURG and PORT HOPE (except Saturdays, when she leaves on the arrival of afternoon train from Rochester at 3 o'clock), connecting there with the Grand Trunk and Midland Railroad trains for all points in Canada; calls at Brighton on Thursday mornings.

RETURNING,

leaves COBOURG every morning at 7:30; PORT HOPE at 9:40, on arrival of Grand Trunk morning trains from East and West, and Midland trains from the North. This is the favorite route from Rochester for

**TORONTO, BELLEVILLE, KINGSTON, BROCKVILLE,
PRESCOTT, OTTAWA, CORNWALL, Messena Springs,
MONTREAL, &c. And from Oswego to Toronto, Belleville, &c.**

The celebrated Rice Lake Fishing and Hunting Grounds; the new places of Summer Resort—the "Arlington" Hotel at Cobourg, the "Mount Julian" Hotel at Lakefield, the "Couchiching" Hotel at Lake Couchiching, the Saratoga of the North—are reached by this route. Though less expensive than longer established resorts, they offer equal accommodation, with more bracing air, and unrivalled Trout, Bass and Maskinonge Fishing.

Excursion Tickets for the round trip furnished at reduced rates.

Cars leave N. Y. Central Depot to connect with Steamer alongside Depot at Charlotte.

GEO. SCHOFIELD, Agent,

92 Mill Street, Rochester, N. Y.

Or, R. CRAWFORD, Port Hope, Ont.

A. R. PRITCHARD & LIKLY,

*Steamer Trunks--Something New,
No. 78 STATE STREET.*

ERIE RAILWAY,

Freight and Passenger Depots on Exchange Street.

Office, 4 State Street.

Receiver—H. J. JEWETT, New York.
 Assistant to the Receiver—G. R. Blalahan.
 Gen'l Superintendent—E. S. BOWEN, New York.
 Auditor—S. LITTLE, New York.
 Gen'l Passenger Agent—J. N. ABBOTT, New York.

General Freight Agent—R. C. VILAS, New York.
 Supt. Rochester Division—R. G. TAYLOR.
 Supt. Buffalo Division—R. G. TAYLOR, Buffalo.
 Cont. Agent—B. F. HARRIS, 4 State St. Rochester.
 Passenger Agt—E. G. BILLINGS, 4 State St., Roch.

ERIE DESPATCH,

Fast Freight Line

FROM NEW YORK TO ROCHESTER.

Established especially to accommodate Rochester Merchants. Every exertion is being made to meet their wants.

Freights delivered at Erie Depot,

Foot of DUANE STREET, Pier 31 NORH RIVER, NEW YORK,

are loaded directly into cars that are locked, sealed and forwarded at once to Rochester by the **Fastest Express Freight Trains**, thus avoiding delays and damaging transfers.

Rates always as Low as by other Lines, and Time Quicker.

Mark packages **E. D.**, and deliver as above. For Rates, Bills of Lading, or other information, apply to

A. H. WARD, Exp. Frt. Agent,
 401 Broadway, New York.

GEO. J. CALDWELL, Exp. Frt. Agent
 305 Broadway, New York.

ERIE FAST FREIGHT LINE,

FROM ROCHESTER to New York, Boston, Albany, Philadelphia and Buffalo.

☞ Mark Packages. **E. R.**, and deliver at Depot, on EXCHANGE STREET, ROCHESTER.

WESTWARD BOUND

FAST FREIGHT LINES,

ERIE & NORTH SHORE LINE,	} J. W. SMITH, Gen'l Manager, Chicago, Ill.
GREAT WESTERN DESPATCH,	
SOUTH SHORE LINE,	
ERIE & PACIFIC DESPATCH,	
DIAMOND LINE, - - - -	} R. R. DUVAL, Gen'l Manager, New York.
	} A. H. McLEOD, Gen'l Manager, Toledo, O.

FREIGHT FORWARDED THROUGH WITHOUT TRANSFER

To CLEVELAND, CINCINNATI, ST. LOUIS, CHICAGO, ST. PAUL, OMAHA, SAN FRANCISCO,

And all Points West, North-west and South-west.

For Rates and Bills of Lading, apply to

R. C. VILAS, Gen'l Frt. Agent,
 New York.

B. F. HARRIS, Cont'g Agent,
 4 State St., Rochester, N. Y.

J. E. BUTTERFIELD, Agent, Rochester.

☞ General Ticket Office of the Erie Railway, No. 4 State Street, Rochester, N. Y.

☞ Tickets sold to All Points East, South, South-west and West, lower than by any other route. Pullman Palace Cars run daily through from Rochester to New York, without change.

E. G. BILLINGS, Passenger Agent, Rochester.

HENRY C. WISNER,

KEROSENE CHANDELIERS, BRACKETS,
 and LAMPS--No. 33 STATE STREET.

GREAT CENTRAL ROUTE

To the West,

VIA

NIAGARA FALLS.

GREAT WESTERN

—AND—

Michigan Central Railways.

The Popular Route to points in Canada; to Detroit, Bay City, Saginaw, Grand Rapids and all points in Michigan; Chicago, Milwaukee, St. Paul, St. Louis, Omaha, San Francisco, Denison, Dallas, Galveston, and all points West.

THE CELEBRATED

Wagner Palace Drawing-Room and Sleeping Cars

Run on all Express Trains from Rochester to Detroit, Chicago, and all points West, WITHOUT CHANGE.

New and Elegant Dining Cars

have recently been placed upon this Line; affording every traveler on the Through Train an opportunity of enjoying Breakfast, Dinner and Supper at leisure, at the popular price of 75 cents per meal.

This is the Only Route to the West, via NIAGARA FALLS, affording an opportunity to our patrons of viewing the FALLS and SCENERY OF NIAGARA while crossing the Niagara River Suspension Bridge.

R. S. LEWIS, Agent, - 95 Waverly Block,

Near New York Central Railroad Depot,

ROCHESTER, N. Y.

From whom Tickets, Sleeping Car Berths and fullest information can be obtained.

J. Q. A. BEAN, G. E. Agent,
New York.

A. J. HARLOW, E. P. Agent,
Boston, Mass.

WM. H. LESLIE, G. T. Acct.,
164 State Street, Rochester, N. Y.

W. F. SHERWIN, Travelling Agent,
Elmira, N. Y.

A. R. PRITCHARD & LIKLY,

SHAWL STRAPS,
No. 78 STATE STREET.

“CANADA SOUTHERN”

Fast Freight Line.

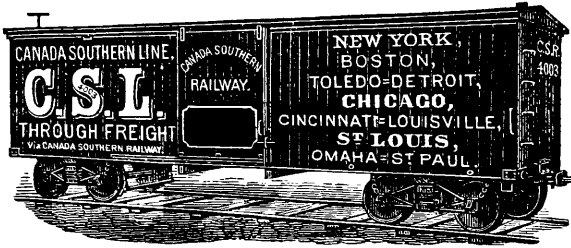

Through Cars.—No Transhipment.—Fast Time.—Low Rates.

Composed of the following Railroad Companies :

NEW YORK CENTRAL & HUDSON RIVER,
CANADA SOUTHERN,
TOLEDO, WABASH & WESTERN,
MICHIGAN CENTRAL,
CINCINNATI, HAMILTON & DAYTON and
DAYTON & MICHIGAN,
INDIANAPOLIS, PERU & CHICAGO,

JEFFERSONVILLE, MADISON & INDIAN-
APOLIS,
TOLEDO, PEORIA & WARSAW,
EVANSVILLE, TERRE HAUTE & CHICAGO,
EVANSVILLE & CRAWFORDSVILLE,
CINCINNATI, LAFAYETTE & CHICAGO.

DETROIT, } GRAND RAPIDS, SAGINAW,
 } JACKSON, KALAMAZOO.
CHICAGO, } ST. PAUL, MINNEAPOLIS, MILWAUKEE, OMAHA,
 } SAN FRANCISCO, and all Points West and
 } North-West.
TOLEDO, } CINCINNATI, DAYTON, INDIANAPOLIS, DECATUR,
 } LOGANSPORT, NEW ORLEANS, HANNIBAL,
 } QUINCY.
ST. LOUIS, } DENVER, KANSAS CITY, ST. JOSEPH, FORT
 } SCOTT, GALVESTON, HOUSTON, and
 } all Points in the South-West.

Special Rates and other information can be obtained of

WM. B. HOYT, Gen'l Agent, New York State and Vermont,

100 Railroad Avenue, Rochester, N. Y.

**WM. E. HOYT, Ticket Agt, Canada Southern Ry.,
AND WAGNER SLEEPING CAR CO.**

Tickets to all Points West, North-West and South-West; Philadelphia,
Washington and Baltimore.

No. 100 RAILROAD AVENUE,

NEXT TO CONGRESS HALL,

ROCHESTER, N. Y.

HENRY C. WISNER,

**CRYSTAL BUD VASES, EPERGNES, ETC.,
No. 33 STATE STREET.**

“BLUE”

FAST FREIGHT LINE,

Via *BUFFALO* and *SUSPENSION BRIDGE*

AND THE

GREAT WESTERN RAILWAY,

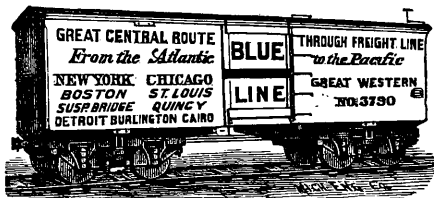

Connecting at *DETROIT* with the

Michigan Central,
 Detroit, Lansing & Lake Michigan,
 Detroit & Bay City,
 Detroit & Milwaukee, and
 Flint & Pere Marquette Railroads,
 FOR POINTS IN MICHIGAN.

At *CHICAGO*, with the

Chicago, Burlington & Quincy,
 Chicago & North-Western,
 Chicago, Milwaukee & St. Paul,
 Chicago, Rock Island & Pacific,
 Chicago & Alton, and
 Illinois Central Railroads,

—FOR—

Burlington, Quincy, Hannibal, Keokuk, Louisiana, Dubuque, Davenport,
 ROCK ISLAND, ALTON, SPRINGFIELD, BLOOMINGTON, CAIRO,
ST. LOUIS,

Kansas City, St. Joseph, Omaha,

And Places in *ILLINOIS*, *WISCONSIN*, *MINNESOTA*, *IOWA*, *NEBRASKA*, *MISSOURI*, *KANSAS*,
TEXAS, *CALIFORNIA*, and intervening Territories.

RATES GIVEN to Points in *TENNESSEE*, *MISSISSIPPI*, *FLORIDA*, *GEORGIA*,
ALABAMA, *LOUISIANA*, and other Southern States.

Don't be afraid to ask for information you want; if we cannot give it will tell you who to apply to.

Time as Fast and Rates as Low as by any other Route. Cars run through without transfer.

Shippers on the line of the New York Central Railroad and its tributary points will please mark packages "BLUE LINE."

For Tariffs, Special Rates and any desirable information, apply to

A. FELL,

166 State Street, or 95 Waverly Block, Rochester, N. Y.

A. R. PRITCHARD & LIKLY,

Trunks and Bags, Wholesale and Retail, No. 78 State Street.

RAILROADS.

AVON, GENESEO & MT. MORRIS RAILROAD CO. Capital \$200,000. *Directors*, Mortimer F. Reynolds, E. R. Hammatt, Henry L. Fish, Wm. Mudgett, Geo. Ellwanger, of Rochester; Willis Phelps, Geo. W. Phelps, of Springfield, Mass.; D. H. Fitzhugh, W. A. Wadsworth, of Geneseo; H. P. Mills, H. E. Brown, L. C. Brigham, William D. Fitzhugh, of Mt. Morris. This road is leased for a long term to Erie Railway.

NEW YORK CENTRAL & HUDSON RIVER RAILROAD. Passenger Depot, Mill cor. Front. *Directors*, Cornelius Vanderbilt, Cornelius Vanderbilt, jr., William H. Vanderbilt, William K. Vanderbilt, Augustus Schell, Samuel F. Barger, Joseph Harker, Chauncey M. Depew, John E. Barrett, New York; Walter S. Church, Albany; Chester W. Chapin, Springfield, Mass; George J. Whitney, Rochester; James M. Marvin, Saratoga Springs.

ROCHESTER & GENESEE VALLEY RAILROAD. Incor. 1852. Capital \$552,000. *Pres't*, Jas. Brackett; *Vice-Pres't*, W. N. Sage; *Sec. and Treas.* C. E. Upton; *Directors*, Amon Bronson, Henry C. Roberts, C. E. Upton, Jas. Brackett, D. W. Powers, John Lutes, Wm. N. Sage, E. R. Hammatt, G. H. Perkins, Jerome Butterfield, S. D. Porter, Johnson I. Robins, L. A. Ward. This road is leased for a long term to the Erie Railway for 6 per centum on stock.

ROCHESTER, NUNDA & PENNSYLVANIA RAILROAD. Incor. 1870. Capital \$800,000. General Office at Mt. Morris. *Pres.* A. Lockhart; *Vice-Pres.* Geo. W. Aldridge; *Sec.* Henry F. Seymour; *Treas.* C. L. Bingham; *Directors*, H. C. Wisner, G. W. Aldridge, Rochester; A. W. Miner, Friendship; C. L. Bingham, Mt. Morris; Samuel Swain, Geo. W. Osgoodby, Nunda; H. P. Mills, Mt. Morris; A. Lockhart, D. P. Richardson, Angelica; B. F. Dow, G. W. Root, York; J. C. Wicker, Leicester; F. D. Lake, Nunda.

ROCHESTER & STATE LINE RAILWAY, Incor. July, 1869. Capital \$2,500,000. *Vice-Pres.* Oliver Allen; *Sec. and Treas.* D. McNaughton; *Directors*, George E. Mumford, M. F. Reynolds, C. F. Smith, Edward Harris, G. H. Perkins, Geo. Darling, Thos. Leighton, of Rochester; William Bristol, of Warsaw; Oliver Allen, of Mumford; J. Tillinghast, of Buffalo; D. D. S. Brown, of Scottsville; A. D. Scott, of Salamanca. Office 114 Arcade,

NORTHERN CENTRAL RAILWAY CO.

THREE FAST TRAINS DAILY.

THE BEST ROUTE TO THE CENTENNIAL.

And only line that will carry passengers *via* the celebrated

WATKINS GLEN, MINNEQUA SPRINGS,

And through the beautiful valley of the Susquehanna River.

No dust, as road is thoroughly stone ballasted.

Pullman Palace Sleeping Cars running through to Philadelphia without change. EXCURSIONISTS can stop off at any point.

A SPECIAL DAYLIGHT TRAIN

Is run from WATKINS to PHILADELPHIA, for accommodation of parties who desire to stop over and visit Watkins Glen, leaving Watkins at 8 A. M., arriving at Philadelphia at 7:20 P. M.

EXCURSION TICKETS are issued by this line, embracing New York, Philadelphia, Baltimore, Washington, Harrisburg, Pittsburgh, Oil City, Corry, Brocton, Dunkirk and Erie, Pa. Pamphlets descriptive of the route elegantly illustrated can be obtained at office of Western Passenger Agent, or at any Ticket Office in this city.

SAMUEL L. SEYMOUR,
Western Passenger Agent,

42 Exchange St., Buffalo.

D. M. BOYD, Jr.,
General Passenger Agent,

Philadelphia.

HENRY C. WISNER, COCKSON & CHETWYND'S WHITE GRANITE
WARE, No. 33 STATE STREET.

STREET CARS.

ROCHESTER CITY AND BRIGHTON RAILROAD. Incor. 1863. Office 113 West Main. Depot, State street cor. Centre. *Pres.* Patrick Barry; *Sec.* C. C. Woodworth; *Treas.* C. B. Woodworth; *Attorney,* Charles S. Baker; *Supt.* Thomas J. Brower.

STAGES.

CHILI (Clifton)—Leaves National Hotel at 3 P. M. tri-weekly.
GREECE—Leaves Sprague's Hotel at 3 P. M. daily.
HONEOYE FALLS—Leaves Chapman Hotel at 3 P. M. Tuesdays and Fridays.
PENFIELD—Leaves Whitcomb House at 3 P. M. daily.
WEBSTER AND ONTARIO—Leaves Whitcomb House at 3 P. M, daily.
RUSH, VIA HENRIETTA—Leaves Clinton Hotel at 3 P. M. daily,

OMNIBUSES.

EAST AVENUE—Leave State corner West Main street half hourly from 8:30 A. M. to 6:30 and at 7:30 and 9:15 P. M. to Little's nursery on East avenue.
LYELL STREET—Leave State corner West Main, seven trips each way daily, to Toll Gate, Lyell street.

BANKS.

BANK HOURS 10 A. M. to 3 P. M.

Bank of Monroe.—No. 22 Exchange street. *Pres.* Jarvis Lord; *Cashier,* Wm. R. Seward.

Bank of Rochester.—41 State street. *Pres.* Charles H. Chapin, *Cashier,* Geo. M. Sweet.—(See page 501)

City Bank.—No. 34 State street. *Pres.* Thomas Leighton jr.; *Cashier,* Charles E. Upton. (See page 495)

Commercial Bank. — No. 31 W. Main street. *Pres.* Hobart F. Atkinson; *Cashier,* Henry F. Huntington.

Flour City National Bank.—State street corner West Main. *Pres.* F. Gorton; *Cashier,* William A. Waters.

Traders' National Bank.—Masonic block, West Main corner Exchange. *Pres.* S. L. Brewster; *Cashier,* H. C. Brewster.—(See page 494)

SAVINGS BANKS.

East Side Savings Bank.—127 E. Main. Incor. 1869. *Pres.* H. S. Hebard; *Sec. and Treas.* P. B. Viele. Amount deposits, June 1st, 1875, \$660,000; number of depositors, 2,000. Annual Meeting 1st Monday in January. (See page 498½)

Mechanics' Savings Bank of Rochester.—No. 15 Exchange street. Inc. April, 1867. *Pres.* Patrick Barry; *Sec. and Treas.* J. H. Rochester. (See p. 498)

Monroe County Savings Bank.—No. 31 State street. Incor. April, 1850. *Pres.* George G. Clarkson; *Sec. and Treas.* Jonathan E. Pierpont. (See page 497)

Rochester Savings Bank.—West Main cor. Fitzhugh street. Inc. 1831. *Pres.* Elijah F. Smith. *Sec. and Treas.* Edward R. Hammatt. Dividends payable 1st June and 1st December. Amount of deposits June 1st, 1876, \$7,483,332.11; number of depositors, 15,206. Annual meeting 1st Monday in February. (See page 496)

Safe Deposit Co.—31 State street. Inc. 1868. Capital, \$100,000. *Pres.* William N. Sage; *Vice Pres.* J. E. Pierpont; *Sec.* Wm. J. Ashley. (See page 499)

LEGAL HOLIDAYS.

There are 7 legal holidays; 1st January; 22d February; 30th May; 4th July; Tuesday following 1st Monday in November, or day of State election; any day appointed by the Governor of the State, or the President of the United States, as a day of public fast or thanksgiving; Christmas Day. Notes falling due on Sunday or legal holiday must be paid on the day preceding, and if a legal holiday occurs on Monday, notes falling due must be paid on Saturday preceding.

SOCIETIES AND ASSOCIATIONS.

Abelard Club.—137 Powers' buildings. Organized 1872. Incorporated 1875. *Pres.* P. S. Wilson; *Vice Pres.* H. H. Craig; *Sec.* H. P. Langworthy; *Treas.* D. T. Hunt. Annual meeting in January. Composed of Knights Templar only.

Amalgamated Society of Engineers, Machinists, Millwrights, Smiths and Pattern Makers.—*Pres.* Fred. Skinner; *Sec.* John Buckley, Roch. Branch. Meets every other Monday at 12 North Water street. Officers chosen semi-annually.

A. J. O. K. S. B.—**FLOUR CITY LODGE No. 117.**—*Secretary,* A. Shorneberg; *W. Ae.* N. Cashman. Meets every other Sunday at Keeler's Hall. **MONROE LODGE 105.**—Organized 1873. *W. Ae.* Geo. Rosenberg; *Rec. Sec.* Isaac Beir. Meets alternate Sundays at Englert's Hall. Semi-annual meetings in January and July.

American Tract Society.—Organized 1825. *Pres.* Hon. Wm. Strong, LL. D., of Washington, D. C. *Cor. Sec.* Rev. J. M. Stevenson, D. D., of New York. *Treas.* O. R. Kingsbury, of New York. Rochester Branch. *Dist. Secretary,* Rev. W. V. Couch; *Supt. of Colportage and Publications,* O. D. Grosvenor, 75 State street. Annual meeting on the Wednesday before the second Thursday in May.

Amity Club.—Organized March 17, 1872. *Pres.* W. A. Williamson, *Vice Pres.* G. P. Meyer, *Dr.* J. P. Bryant; *Rec. Sec.* Jas. R. Goodman; *Fin. Sec.* W. W. Quine; *Treas.* Chas. W. Yaky. Rooms 177 and 178 Powers' buildings. Meets the first Tuesday in each month. Annual meeting second Tuesday in April.

Arion Singing Society.—Organized 1863. *Pres.* John Mauder; *Vice Pres.* Joseph Groh; *Rec. Sec.* Robert Siebert; *Fin. Sec.* J. C. Fohner. Meets second Thursday in each month. Annual meeting second Thursday in October.

Audubon Sportsman's Club.—Organized 1865. *Pres.* James Brackett; *Vice Pres.* C. C. Morse; *Sec.* Wm. L. Markell; *Treas.* C. T. Amsden. Meets first Saturday of each month. Annual meeting first Saturday in April. Rooms in Arcade.

Bergh Association of Rochester.—*For the Prevention of Cruelty to Animals.*—Organized 1873. *Pres.* W. H. Cheney; *Vice Pres.* Mrs. J. L. Angle, Mrs. Amon Bronson; *Cor. Sec.* Miss Elizabeth Hall; *Rec. Sec.* Mrs. J. W.

Stebbins; *Treas.* Henry S. Hanford; *Agent,* Wm. H. Griffin. Regular meetings first and third Wednesday of each month. Annual meeting first Thursday after January first.

Birds and Worms.—Incorporated 1872. *Pres.* Henry S. Hebard; *Vice Pres.* Conrad Herzberger; *Cor. Sec.* J. Q. A. Hempsted; *Treas.* Walter Weldon; *Fin. Sec.* J. G. Maurer. Meets over 16 Exchange place first Friday in each month. Annual meeting first Friday in January. For the protection of fish and game, and to enforce game laws of the State.

Brotherhood of Locomotive Engineers.—Rochester Division No. 18. Organized 1863. Rooms State corner Mumford. *C. E.,* L. H. Sanford; *F. E.,* A. Erhardt; *F. A. E.,* W. H. Dawson; *S. A. E.,* H. M. Case; *Cor. Sec.* Chas. Thomas. Meets every Saturday evening. Officers chosen the first regular meeting in August.

Carmen's Benevolent Association. Organized January, 1848. *Pres.* James Gosnell; *Vice Pres.* John McMullen, Thos. H. Hopkins; *Sec.* John Swanton; *Treas.* John Quinlan. Meets the first Thursday evening of each month. Annual meeting the first Thursday in January.

Celtic Club.—Organized 1874. Rooms 134 Powers' buildings. *Pres.* P. Mahon; *Vice Pres.* D. C. Feely; *Sec.* James Laverty; *Treas.* J. J. Evans; *Trustees,* Wm. Gleason, J. Connell, P. C. Conroy. Meets every Monday evening. Annual meeting in April.

Church Home of the Protestant Episcopal Church of the City of Rochester. Mt. Hope avenue opposite King's nursery. Organized June 10th, 1868. Incorporated September 10th, 1869. *Pres.* Mrs. D. M. Dewey; *Vice Pres.* Mrs. H. Sibley; *Cor. Sec.* Mrs. M. M. Mathews; *Rec. Sec.* Mrs. Wm. C. Rowley; *Treas.* Miss C. L. Rochester. Regular meetings first Friday of each month. Annual meeting All Saints Day, November 1st.

Citizens' Association.—Organized March 31, 1871. *Pres.* Wm. N. Sage; *Vice Pres.* George G. Clarkson, P. Barry; *Sec.* C. F. Paine; *Treas.* C. E. Upton; *Exec. Com.* D. W. Powers, Ezra Jones, Samuel Wilder, E. R. Andrews, and the officers of the Association. Regular meetings last Thursday of January, May and September. Annual meeting in January.

HENRY C. WISNER,

BACCARAT TABLE DE SERVICE,
No. 33 STATE STREET.

Exempt Firemans' Association.—Organized January 26th, 1869. *Pres.* John Quinn; *Sec.* T. N. LeRoss; *Treas.* John T. Fox. Regular meeting, first Wednesday in each month at city building Front street. Annual meeting first Wednesday in January.

Fire Department of the City of Rochester, Trustees of the (*formerly Fireman's Benevolent Association*). Incorporated 1836. *Pres.* Joseph B. Ward; *Vice Pres.* John Cowles, Samuel M. Stewart; *Sec.* Lyman M. Newton; *Treas.* John T. Fox; *Collector*, Law S. Gibson. Meetings second Monday of each month, at city building, Front street, second floor. Annual meeting second Monday in December. This body is incorporated for the purpose of taking charge of certain moneys assessed by law, upon all fire insurance companies outside of the State, doing business in Rochester. The money so received is devoted to the relief of indigent firemen and their families. This fund amounts to about \$36,000, yielding an annual income of about \$2,500.

Genesee Yacht Club.—Organized 1874. *Pres.* P. S. Wilson; *Treas.* Thos. W. Allen; *Fin. Sec.* Wm. Smith jr.; *Rec. Sec.* E. N. Millard; *Commodore*, Geo. H. Newell; *Vice Commodore*, E. M. Moore jr.; *Rear Commodore*, W. A. Stace. Rooms 93 Arcade. Annual meeting in April.

German Catholic Union.—Organized July 20th, 1873. *Pres.* Joseph Schutte; *Vice Pres.* John B. Hahn; *Sec.* Louis J. Ernst; *Treas.* Wendel Fischer; *Com.* Louis Ernst; *First Asst. Com.* Geo. A. Begy; *Second Asst. Com.* A. G. Ringelstein; *Third Asst. Com.* Joseph Hesslinger. Regular meetings second Monday of each month, at Schlitzer's hall, corner of Clinton and Andrews street. Annual meeting July 20th.

German Mutual Aid Society.—Organized 1874. *Pres.* Louis Bauer; *Vice Pres.* Chas. Siebenpfeiffer; *Sec.* G. H. Haass, *Treas.* C. F. Wolters. *Directors*, Louis Bauer, G. Rosenthal, Charles Siebenpfeiffer, L. W. Brandt, Jacob Katz.

Grand Army of the Republic.—Dep't of N. Y. O'Rourke Post, No. 1. Organized 1866. City bldgs. Front street. *Post Com.* Richard H. Schooley; *Sen. Vice Com.* John T. Tracy; *Jun. Vice Com.* James Plunkett, *Adj.* Jas. H. Moore. Meets Thursday evenings. Officers elected last Thursday of Dec. GEO. H. THOMAS POST, No. 4. Meets first Tuesday of each month, rooms cor. State street and Exchange place. *Post*

Com. J. A. Reynolds; *Sen. Vice Com.* S. B. Williams; *Jun. Vice Com.* J. A. Graham; *Adj.* Charles W. Wall; *Q'master*, A. H. Bruman. PEISNER POST, No. 106. Rooms E. Main cor. Stone streets. *Post Com.* Geo. Gadwell; *Sen. Vice Com.* August Bauer; *Jun. Vice Com.* Ferdinand Propping; *Adj.* Adam Brasch. Meets alternate Thursdays. Officers elected in December.

Hebrew Benevolent Society.—Organized 1850. *Pres.* Joseph Beir; *Vice Pres.* Levi Adler; *Sec.* Joseph Cauffman; *Treas.* S. Rosenblatt. Meets N. Water corner of Atwater every second Sunday in each month. Annual meeting in December

Hebrew Ladies' Benevolent Society.—Organized 1865; meets at Synagogue on last Sunday in each month. Annual meeting last Sunday in January. *Pres.* Mrs. S. Rosenblatt; *Vice Pres.* Mrs. M. S. Vanderbergh; *Sec.* Mrs. S. Guggenheim; *Treas.* Mrs. S. Cohn.

Independent Order of Forresters.—COURT PROSPERITY, No. 12. Organized April 28th, 1875.—*C. R.*, S. J. Lovecraft; *V. C. R.*, John T. Gosselin; *Sec.*, John McCaw; *Treas.* Henry Griffin. Meets every Wednesday evening.

I. O. F. S. of I.—Organized 1872. ROCHESTER CONTINENTAL LODGE, No. 45.—*Pres.* Adolph B. Katz; *Vice Pres.* S. Rice; *Sec.* F. S. Leseritz, *Chaplain*, Isaac Beir; *Treas.* Jos. Mandle. Meets every Monday. N. Water corner Andrew streets. Semi-annual meetings in January and July.

Industrial School of Rochester.—Incorporated 1857. *Pres.* Mrs. George F. Danforth; *1st Vice Pres.* Mrs. Nehemiah W. Benedict; *2d Vice Pres.* Mrs. H. Sibley; *3d Vice Pres.* Mrs. Isaac Butts; *4th Vice Pres.* Mrs. Alfred Ely; *Treas.* Mrs. Lewis H. Morgan; *Cor. Sec.* Mrs. Gerard Arink; *Rec. Sec.* Mrs. Gilman H. Perkins. Annual meeting first Saturday after the first Friday in January. The objects of the Association are to gather into the school vagrant and destitute children, who from the poverty or vice of their parents, ARE UNABLE TO ATTEND THE PUBLIC SCHOOLS, and who gather a precarious livelihood by begging or pilfering; to instruct them in the elements of learning, and enable them to become useful members of society.

Knights of St. Crispin, Lodge 20.—Organized March, 1868. *C. S.* Frank Piffer; *R. S.*, Joseph St. Cyr; *S. K.*, O. W. Beach. Meets first and third Wednesday evenings of each month, over 100 State street. Officers chosen

third Wednesdays in June and December.

Knights of St. James.—Organized 1873. Incorporated 1874. *Pres.* L. R. Flynn; *Vice Pres.* John Haley; *Rec. Sec.* Charles Stupp; *Fin. Sec.* M. J. Malican; *Treas.* P. Haley. Meetings every Wednesday evening. Annual meeting in June.

Lattimore Free Lecture Association.—Organized March 1875. *Directors*, F. H. Clement, John Siddons, James S. Graham, George W. Archer, H. S. Briggs, John Connell, Charles Porter, E. Mapes, Professor Lattimore, D. D. Sulley. Annual meeting in October.

Machinists' and Blacksmiths' Union.—Organized 1857. *Pres.* Elias Mapes, *Vice Pres.* William Steinhauser, *Cor. Sec.* C. B. Chapman, *Fin. Sec.* Seth Braggins, *Treas.* George Langdale. Officers chosen semi-annually. Meets first and third Monday of each month in Potter's block.

Mechanics' Mutual Benefit Society.—Organized 1874. *Pres.* Chas. A. Mills; *Vice Pres.* John T. Gosselin; *Treas.* James V. Laing, *Sec. Relief Com.* George H. Andrews. Number of members 152. Annual meeting January 25th.

Mecklenburg Sick Men and Widow Relief Society.—Organized February, 1863. *Pres.* John Jacobs; *Vice Pres.* John Engel; *Sec.* Gustav Mier; *Treas.* Charles Priem. Annual meeting last week in December. Number of members, 150.

Monroe County Bible Society.—*Pres.* William Alling; *First Vice Pres.* David Dickey; *Second Vice Pres.* Ezra Jones; *Cor. Sec.* Rev. S. A. Lattimore, *Rec. Sec.* William R. Seward; *Lib. and Treas.* O. D. Grosvenor. Annual meeting in March. Depository, 75 State street, Rochester.

Monroe County Homœopathic Society.—Organized 1866. *Pres.* E. H. Hurd; *Vice Pres.* R. A. Adams; *Secy. and Treas.* George F. Hurd. Regular meetings third Tuesday in January, April, July, October. Annual Meeting in January.

Monroe County Medical Society.—Organized May 9th, 1821. *Pres.* Dr. J. I. Denman; *Vice Pres.* Dr. M. L. Lord; *Secy.* J. W. Whitbeck; *Treas.* Dr. G. A. Wallace. Annual meeting last Wednesday in May.

Monroe County Sportsman's Club.—Room 93 Arcade. *Pres.* A. V. Lamberton; *Vice Pres.* J. H. Brown; *Secy. and Treas.* L. A. Pratt. Meets first

Thursday of each month. Annual meeting first Thursday in March.

Old Cadets.—Organized August 15, 1871. *Pres.* Wm. Vandolah; *Vice Pres.* James Cunnean; *Sec.* John O. Muth; *Treas.* George C. McMahon. Charter members of Company G., Fifty-fourth regiment, and those who joined on or before July 1st, 1863, comprise the association, and meet once a year for social purposes. Annual meeting June 21.

Old School Boys.—Organized 1872. *Pres.* Charles B. Hill; *Vice Pres.* Jas. D. Cobb; *Sec.* William G. Congdon; *Treas.* Henry F. Smith. Annual meeting second Thursday in May.

"Old Star Club."—Incorporated 1872. *Pres.* Jas. B. Williams; *Vice Pres.* Charles A. Bruff; *Sec. and Treas.* Samuel B. Williams. Cottage, Irondequoit Bay. Incorporated 1872. Meets first Monday in each month at 85 Exchange. Annual meeting first Monday in August.

Orient Club.—Organized 1871.—*Pres.* R. S. Williamson; *Vice Pres.* C. J. Hancock; *Sec.* John Roda; *Treas.* F. B. Graves. Meets last Monday of each month.

Orphan Boys' Asylum.—Under the charge of the Sisters of St. Joseph. West avenue cor. Genesee. Children received from 3 to 12 years of age. Average number, 144.

Pathological Society.—Organized August 1, 1871. *Pres.* A. O'Harr; *Vice Pres.* Byron I. Preston; *Secy.* Louis A. Weigel; *Treas.* Chas. Buckley. Regular meetings second and fourth Fridays in each month. Officers chosen semi-annually.

Phoenix Club.—No. 8 North Clinton street. Organized 1873. *Pres.* Max Brickner; *Vice Pres.* Marcus Cauffman; *Secy.* Lewis Stern; *Treas.* N. Stein. Trustees meet first and third Wednesday of each month. Annual meeting second Sunday in December.

Riverside Rowing Club.—Organized September 7th, 1869. Incorporated 1872. Boat house foot Griffith street, Genesee river. *Pres.* R. H. Lansing; *Rec. Sec.* E. J. Raymond; *Treas.* Charles W. Huntington; *Fin. Sec.* A. H. Bruman; *Captain*, Dr. E. V. Stoddard. Meets first Wednesday of every month. Annual meeting first Wednesday in April.

Rochester Academy of Art.—Organized 1875. Rooms in Free Academy building. *Pres.* Lewis H. Morgan; *Vice Pres.* S. A. Lattimore; *Sec. E.*

Clifton; *Treas.* Clinton Rogers. *Directors*, M. F. Reynolds, A. S. Mann, D. M. Dewey, J. R. Thomas, H. H. Warner, S. A. Ellis, Chas. J. Burke, A. H. Mixer, J. M. Mundy. Meets second Monday evening in each month. Annual meeting second Monday in January.

Rochester Athenæum and Mechanics' Association.—Howe's blk. 40 Fitzhugh street. Incorporated 1830. *Pres.* Jonas Jones; *Vice Pres.* Marcus Michaels, Jacob Howe jr.; *Treas.* A. E. Wolff; *Cor. Secy.* D. D. Sulley; *Rec. Sec.* S. Wile; *Librarian*, Mrs. C. B. Ayers. Meetings second Monday in the month. Annual meeting in May. Number of members, about 800. Annual subscription \$2.00. Volumes in library, 20,000. Apprentices and clerks, properly recommended and approved, can use the Reading Room without charge, and can take books from the library upon payment of one dollar per annum.

Rochester Athletic Association.—Incorporated January 3d, 1873. Capital stock \$3,000. Gymnasium and Boat House foot of Griffith street, Genesee river. *Pres.* Hiram H. Edgerton; *Secy. and Treas.* Theron E. Parsons.

Rochester Club.—Incorporated '69. Ellwanger & Barry's block, 35 State street. For social purposes only. *Pres.* John H. Rochester; *Vice Pres.* W. H. Cummings; *Sec.* George M. Elwood; *Treas.* William M. Colvin. Business meetings first Saturday in each quarter.

Rochester Driving Park Association.—Organized 1873. Grounds on McCracken street. *Pres.* George J. Whitney; *Sec. and Treas.* E. B. Parsons. Annual meeting second Tuesday in January.

Rochester Female Charitable Society.—Organized 1822, for the relief of the sick poor. *Pres.* Mrs. Maltby Strong; *Vice Pres.* Mrs. F. Clarke, Mrs. Adolphus Morse, Mrs. W. C. Rowley; *Treas.* Miss R. B. Long; *Secy.* Mrs. Oscar Craig; *Trustess*, Levi A. Ward, Jas. S. Andrews, Dr. Maltby Strong, William N. Sage, Frederick A. Whittlesey, George J. Whitney; *Directresses*, Term expires 1877: Mrs. W. Baron Williams, Mrs. Wm. Pitkin, Mrs. Saml. Hamilton, Mrs. D. M. Dewey, Mrs. S. G. Andrews, Mrs. L. R. Satterlee, Mrs. J. H. Martindale, Mrs. A. McVean, Mrs. G. W. Parsons. Term expires 1876: Miss C. L. Rochester, Mrs. G. E. Jennings, Mrs. Edgar Holmes, Mrs. Henry Thayer, Mrs. W. F. Cogswell, Mrs. George J. Whitney,

Mrs. E. T. Smith, Mrs. Mortimer F. Reynolds, Mrs. S. H. Terry. Meetings first Tuesday of every month. Annual meeting in November.

Rochester Free Dispensary.—Organized 1872. Rooms, City building, Front street. *Pres.* Dr. George A. Wallace; *Vice Pres.* N. A. Stone; *Treas.* Ezra R. Andrews; *Sec.* Dr. John O. Roe; *Trustees*, Edward M. Smith, George G. Cooper, Geo. A. Wallace, Chas. Buckley, Ezra R. Andrews, M. R. Speare, John O. Roe, G. G. Clarkson, S. A. Lattimore, N. A. Stone, M. Filon, C. E. Rider. *Attending Medical Officers*: Monday, Dr. Speare; Tuesday, Dr. Buckley; Wednesday, Dr. Roe; Thursday, Dr. T. A. O'Hare; Friday, Dr. M. L. Mallory; Saturday, Dr. Wallace.

Rochester Hebrew Aid Society.—Organized 1869. *Pres.* M. Greentree; *Vice Pres.*, M. H. Lempert; *Sec.* Geo. Rosenberg; *Treas.* M. Lipsky. Meets first Sunday of every month. Officers elected first Sunday in April.

Rochester Home for the Friendless.—East avenue cor. Alexander st. Organized 1849. Incorporated 1855. *Pres.* Mrs. D. R. Barton; *Vice Pres.*, Mrs. Adolphus Morse; *Rec. Sec.*, Mrs. C. F. Pond; *Cor. Sec.*, Mrs. D. B. Beach; *Treas.* Mrs. S. Porter; *Matron*, Mrs. L. W. Wallace. Meetings third Tuesday of every month. Annual meeting in April.

Rochester Liederkranz.—Organized Nov. 20, 1874. *Pres.* Geo. Fleckenstein; *Vice Pres.* Matthias Marx; *Sec.* Jacob Strassner Jr.; *Treas.* John A. Felsing; *Director*, Rudolph Vay. Meets on the second Sunday of every month.

Rochester Literary Union.—Organized 1875. Rooms in Young Mens' Catholic building. *Pres.* W. Purcell; *Vice Pres.* James Fee; *Sec.* William J. Sheridan. Meets first Monday in every month. Annual meeting first Monday in January.

Rochester Mannerchor.—Organized 1866. *Pres.* Henry Hebing; *Vice Pres.* Henry Hoffman; *Cor. Sec.* Ferdinand Propping; *Fin. Sec.* A. Spielher; *Treas.* John Bausch; *Leader*, F. J. Bauer; *Collector*, Chas. Seitz. Meets at North Clinton cor. Atwater street. Regular meetings first Wednesday of each month. Musical rehearsals every Tuesday and Friday. Officers chosen semi-annually.

Rochester Medical Society.—Organized 1853. *Pres.* E. M. Moore, sr.; *Sec.* M. L. Mallory; *Treas.* C. E. Rider.

Regular meetings are held the first and third Monday of each month. Annual meeting second Monday in December.

Rochester Orphan Asylum.—Hubbell Park. Organized 1837. *Pres.* Mrs. Lysander Farrar; *Vice Pres.* Mrs. George G. Clarkson; *Sec.* Mrs. Martin Briggs; *Treas.* Mrs. William N. Sage; *Acting Matron,* Mrs. Clements; *Pres. of Trustees,* Wm. N. Sage; *Sec. of Trustees,* S. B. Roby. Meeting last Tuesday of every month. Annual meeting second Tuesday in October.

Rochester Philharmonic Society.—Organized October 3d, 1865. *Pres.* David Copeland, Jr.; *Vice Pres.* G. H. Haas; *Sec.* R. H. Lansing; *Treas.* F. T. Finding; *Librarian,* R. H. Lansing; *Conductor and Musical Director,* Henri Appy; *Pianist,* Mrs. C. S. P. Cary. Meets weekly.

Rochester Rifle Guards.—*Pres.* John Raab; *Sec.* Lorenz Keller; *Treas.* Frederick Kesel.

Rochester Typographical Union, No. 15.—Organized April 1853. Re-organized October, 1869. *Pres.* Wm. J. Winfield; *Vice Pres.* Theo. J. Vogel; *Treas.* James B. Spinning; *Rec. Sec.* Clifton B. Bull; *Cor. Sec.* Lewis H. Gibbs; *Fin. Sec.* Louis A. Esson. Officers chosen annually. Meets East Main corner South St. Paul street, first Saturday of every month. Annual meeting first Saturday in December.

Rochester Union Blues.—Organized as a military company in 1861. *Pres.* L. A. Pratt; *Vice Pres.* J. H. Kelly; *Sec. and Treas.* D. Hoyt; *Capt.* Levi F. Ward; *1st Lieut.* Jas. F. Poole; *Orderly Sergt.* David Hoyt. Annual meeting in June.

Rochester Union Grays.—*Capt.* N. Thompson; *Orderly Sergt.* John G. Grey; *Pres.* James L. Angle; *Vice Pres.* John Wegman.

Sisters of Mercy.—No. 5 South street.

Sisters of Notre Dame.—King street near St. Peter's Church.

Society for the Preservation of Personal Liberty.—Organized 1874. *Pres.* Frederick Cook; *Sec.* Wm. Guggenheim. Annual meeting second Tuesday in May.

State Charitable Association.—Rochester Branch. Organized September 10th, 1873. *Pres.* Henry W. Dean; *Vice Pres.* Mrs. Lysander Farrar. Meets last Thursday in each month.

St. Alphonsus Society.—Organized 1853. Meets on the second Sunday of each month, at St. Joseph's hall. *Pres.* Joseph Hoffman; *Vice Pres.* Peter Hatterscheid; *Sec.* Philip Crumbach; *Treas.* Martin Maier. Annual meeting second Sunday in August.

St. Bonifacius Benevolent Society.—Organized 1855. *Pres.* J. J. Weingartner; *Treas.* Leopold Engel. Meets first Sunday in every month.

St. Bonifacius Benevolent Society.—Organized 1861. *Pres.* Caspar Schwalbach; *Sec.* Henry Oberlies; *Treas.* Henry Henkel. Meets first Tuesday of each month. Annual meeting 1st Tuesday in June.

St. Francis Xavier Benevolent Society.—Organized 1868. *Pres.* Rudolph Vay; *Vice Pres.* Geo. A. Begy; *Cor. and Rec. Sec.* August R. Drees; *Treas.* Augustine Baur. Meets at St. Peter's and St. Paul's school house on the second Monday of each month. Annual meeting in December. Number of members 375. Cash capital \$7,000.

St. Francis Xavier Relief Association.—Organized 1874. *Pres.* Geo. A. Begy; *Vice Pres.* Valentine Fleckenstein; *Sec.* August R. Drees; *Treas.* Charles Staud. Meets at St. Peter's and St. Paul's school house on the third Sunday in each month. Annual meeting in March.

St. Francis Young Men's Mutual Aid Society.—St. Mary's Church, South street. Meetings second Sunday in every month; annual meeting in March.

St. Ignatius Young Men's Mutual Aid and Literary Association.—*Pres.* Wm. Hartigan; *Sec.* Luke R. Flynn; *Treas.* James F. Curtin. Meets at St. Patrick's Parochial school house. Annual meeting in June.

St. Joseph's Benevolent Society.—Organized 1850. Rooms at St. Joseph's hall. *Pres.* Valentine Hetzler; *Vice Pres.* Henry Otto; *Sec.* Christian Schlicht; *Treas.* Jacob Fox. Regular meeting first Monday in each month. Annual meeting 19th of March.

St. Joseph's Benevolent Society.—Organized 1864. *Pres.* John Beikirch; *Vice Pres.* Constant Vogt; *Treas.* Joseph Tross. Rooms at St. Bonifacius hall. Regular meeting fourth Sunday in each month. Annual meeting 19th of March.

Young Mens' Christian Association.—Organized August 2d, 1875. Rooms 18 Main St. Bridge. *Pres.* The-ron E. Parsons; *Vice Pres.* A. H. Cole; *Rec. Sec.* Geo. H. Brown; *Gen. Sec.* F. L. Smith. Noon-day meetings every day from 12 m. to 12:45 p. m. Young Mens' Meeting every Monday night 7:30 p. m.; Boys Association every Thursday night 7:30 p. m.; Flower Mission every Friday 10 a. m.; Public Meeting every Saturday night 8 p. m.; monthly meeting 2d Monday of each month; annual meeting 2d Monday in May. Number of members 500. Reading room open every day and evening; Supplied with papers from principal cities.

St. Mary's Society.—Organized Dec. 1st, 1853. *Pres.* Patrick Cooper; *Vice Pres.* Patrick J. Curtis; *Treas.* John Quinlin; *Sec.* Thomas Moore; *Trustees,* John Foley, John Lynch, Wm. Dunne. Meets on the first Sunday of each month; annual meeting in November.

St. Patrick's Female Orphan Asylum.—Frank street near Platt. Under direction of Sisters of St. Joseph.

St. Patrick's Literary and Benevolent Association.—Organized 1857; incorporated 1871. *Pres.* James Burket; *Sec.* Edward Kagney; *Treas.* John Burke. Regular meeting first Sunday in each month at St. Patrick's Parochial school, Brown street. Annual meeting in July.

St. Paul's Society.—Organized 1857. *Pres.* Nicholas Kramer; *Vice Pres.* Alois Ditner; *Sec.* Geo. Draude; *Treas.* John Berna. Meet on the first Monday in each month at St. Peter's and St. Paul's school house; annual meeting in September. Number of members 80.

St. Peter's Society.—Organized 1851. *Pres.* Joseph Young; *Vice Pres.* S. Saxe; *Sec.* Herman Springer; *Treas.* Joseph Gradl. Number of members 108. Meets the last Monday in each month at St. Peter's and St. Paul's school house. Annual meeting June 1st.

Swiss Benevolent and Charity Society.—Organized 1861. *Pres.* Rudolph Alpsteig; *Vice Pres.* Jacob Kaufman; *Rec. Sec.* John B. Zoller; *Treas.* Lewis Bohrer. Meets every other Thursday.

Turn-Verein.—Organized 1851; incorporated 1857. *Pres.* J. W. Niederpruem; *Vice Pres.* P. Gottschalk; *Cor. Sec.* C. Bieber; *Fin. Sec.* A. Hoeft;

Treas. W. Ritter. Meets at Germania Hall, 175 North Clinton street, every Tuesday evening.

Undine Boat Club.—Organized 1872. Boat house north side of Clarissa St. Bridge, Genesee river. *Pres.* Chas. H. Plummer; *Vice Pres.* F. F. Andrews; *Sec.* Fred B. Roades; *Treas.* Geo. H. Barber. Annual meeting first Monday in May.

United Ancient Order of Druids. CONSOLIDATED GROVE No. 20. Organized April 1st, 1876. *P. A.*—P. B. Crossman; *N. A.*—Benj. Thomas; *V. A.*—Joseph Ringelstein; *Sec.* E. Gillis; *Treas.* F. B. Roades, Rep. to G. G. Henry Griffin; Proxy Rep. to G. G. A. Lennox. Dist. dep. G. A. for Monroe dist. H. Griffin.

—GERMANIA GROVE No. 32.—Organized 1875. Meets at Harugari Hall the first and third Wednesday of each month.

Western New York Agricultural Society.—Organized 1840. *Pres.* Thos. Brown jr.; *Sec.* Chas. A. Pool; *Treas.* John W. Stebbins. Annual meeting at Rochester, second Tuesday in January.

Western New York Farmers' Club.—Organized December, 1868. *Pres.* Henry Quinby; *Sec.* and *Treas.* P. C. Reynolds. Elected every six months. Meets first and third Wednesday of each month.

Windsor Club.—Organized April 11, 1875. *Pres.* S. G. Curtice; *Vice Pres.* T. C. Fenn; *Treas.* L. S. Hoyt jr.; *Sec.* Edward U. Willard. Rooms Odd Fellows Temple, West Main street.

Young Mens' Catholic Association of Rochester.—No. 120 West Main street. Incorporated April 3, 1872. *Pres.* Rt. Rev. B. J. McQuaid; *1st Vice Pres.* Chas. Fitzsimons; *2d,* Geo. Carling; *Treas.* Richard Curran; *Rec. Sec.* John C. O'Brian; *Cor. Sec.* Chas. P. Barry. Annual meeting and election of Directors in April. The object of the Association is the improvement of the members in literary, musical, æsthetic, gymnastic and social exercises. Rooms open day and evening. Number of members, 300.

Zerubbabel Lodge, 53, I. O. B. B.—Organized 1864. *Pres.* Max Brickner; *Vice Pres.* Joseph Cauffman; *Sec.* Max Lowenthal; *Treas.* Joseph Beir. Meets Andrews corner North Water. Meetings every Sunday. Officers chosen in January and July.

BUILDING AND LOAN ASSOCIATIONS.

Central Building Aid and Loan Association.—Incorporated 1871. Capital 1,100 Shares at \$125 per share. *Pres.* C. P. Gillard; *Vice Pres.* L. F. Wilder; *Treas.* Theo. S. Paine; *Sec.* William H. Mills. Meets every Friday evening, at room 135 Powers' bldgs. Semi-annual meetings in Feb. and Sept.

East Rochester B. L. Association.—Organized 1872. Capital \$113,000. *Pres.* W. W. Parsells; *Vice Pres.* George C. Maurer; *Treas.* David Rosenberg; *Rec. Sec.* S. B. Williams; *Fin. Sec.* A. C. Allen; *Trustees,* B. S. Van Ingen, Jos. B. Fuller, James Wagstaff, G. J. Kingsbury, E. Baldwin, Cornelius Schulik. Meets every Thursday evening at No. 96 Powers. bldgs. Annual meeting first Thursday in August.

Eighth Ward Building, Aid and Loan Association.—Organized 1873. Capital \$125,000, divided into 1,000 shares, at \$125 each, paid in installments of 25 cents per week. *Pres.* F. C. Whittlesey; *Vice Pres.* Bernard O. Kane; *Sec.* F. W. Avery; *Treas.* John Foley. Meetings held Tuesday evening. Annual meeting first Tuesday in October.

Flour City Saving and Loan Association.—Organized 1871. Capital \$125,000. *Pres.* David H. Westbury; *Vice Pres.* Owen O'Neil; *Sec.* F. W. Avery; *Treas.* D. H. Westbury. Meetings held every Wednesday evening, at Stetzenmeyer's Hall, 171 Plymouth avenue. Annual meeting third Wednesday in December.

Flower City Co-operative Building Lot Association.—Organized 1872. Capital \$65,000. Comprises 79 acres, located west side of Lake avenue. *Pres.* L. Garson; *Vice Pres.* S. Hays; *Treas.* W. W. Gilbert; *Fin. Sec.* Chas. S. Cook; *Rec. Sec.* Daniel Straus. Semi-annual meetings last Wednesdays in May and November.

Frankfort Mutual Aid and Loan Association.—Organized 1873. Capital subscribed \$133,750. *Pres.* Patrick Moran; *Vice Pres.* Wm. O'Connor; *Treas.* Cornelius McDonald; *Sec.* M. L. Burke; *Atty.* D. C. Feely. Meeting every Tuesday evening, at No. 2 Lake avenue.

Fourteenth Ward Co-Operative Building Lot Association.—Organized 1871. Incorporated Sept. 8, 1871. Capital \$150,000. 705 lots, comprises 110 acres, located corner Goodman and Bay streets. *Pres.* Geo. P. Davis; *Vice Pres.* Oliver Hagen; *Treas.* William Doehna; *Fin. Sec.* J. R. Strauchen;

Rec. Sec. L. E. Dake; *Trustees,* Wm. H. Dake, Alex. Button, J. W. Freund, Seymour King, John Strauchen. Meetings held the first Wednesday evening in every month, 102 North street. Annual meeting first Wednesday in July.

Glenwood Mutual Homestead Association.—Organized 1870. Property comprises about 50 acres, located on Rowe street. *Pres.* Chas. S. Baker; *Vice Pres.* Thos. Dransfield; *Treas.* J. B. Sweeting; *Rec. Sec.* Nathaniel Gillard; *Fin. Sec.* John W. Taylor. Meets first Tuesday evening of every month at No. 116 Powers' bldgs.

Independent Building Lot Association.—Organized 1872. *Pres.* Jacob Zoller; *Vice Pres.* A. E. McLain; *Treas.* Geo. Fleckenstein; *Sec.* John Kubel. Meets Friday evenings, at Leonard's Hall, Jay street. Annual meeting first Friday in August. Capital \$35,000. Property comprises 52½ acres.

Jay st. Building Aid and Loan Association.—Organized 1871. Capital \$125,000. *Pres.* George F. Phillips; *Vice Pres.* Geo. Tuety; *Sec.* James M. Niven; *Treas.* Michael Brayer; *Atty.* John A. McGorray. Meets every Thursday evening, at Leonard's Hall, Jay street. Annual meeting last Thursday in June.

Jay Street and Pool Farm Building Lot Association.—Organized '72. Capital \$48,000. Property located on Jay street, comprises 367 lots. *Pres.* and *Treas.* Wm. B. Geddes; *Vice Pres.* Caspar Fromm; *Fin. Sec.* Alfred Marsh; *Rec. Sec.* N. F. Berina. Meetings held at Leonard's Hall, Monday evenings. Annual meeting first Monday in August.

Lake Avenue Park Building Lot Association.—Organized 1872. *Pres.* A. H. Cushman; *Vice Pres.* A. C. Walker; *Rec. Sec.* A. V. Smith; *Fin. Sec.* and *Treas.* J. M. Harrison. Meets first Tuesday evening in every month, over 67 State street.

Maplewood and Lake Av. Co-Operative Bldg. Lot Association.—Org. '72. Capital \$80,000; property comprises 38 acres, located on Lake avenue, north of Maple Grove. Meets every Monday evening, 135 Powers' block. *Pres.* Geo. Frauenberger; *Vice Pres.* Thomas J. Neville; *Treas.* Abraham Stern; *Fin. Sec.* Theo. S. Paine; *Rec. Sec.* Charles S. Cook. Semi-annual meetings on the second Monday in May and November.

Monroe Co-Operative Building Lot Association.—Organized 1872. Amt. paid for land \$36,400; property comprises 37 acres, divided into 179 lots, between Rowe street and Erie canal. *Pres.* Thomas E. Hiltz; *V. Pres.* Dr. J. F. Oaks; *Rec. Sec.* H. J. Bowden; *Fin. Sec.* P. J. Geraghty; *Treas.* Chas. A. Vickery; *Directors,* W. Martin Jones, Chas. A. Vickery, E. S. Ettenheimer, John Craighead; *Attorney,* J. H. Jeffres. Meetings held at 135 Powers' buildings, Tuesday evenings.

Mt. Hope and South Avenue Co-Operative Building Lot Association. Organized 1872. Capital \$32,000. Property comprises 30-45-100 acres, located opposite County's institutions, South av. and Toll Gate on Mt. Hope avenue. *Pres.* John Stewart; *Vice Pres.* Thos. Dove; *Treas.* John McDowell; *Fin. Sec.* H. A. Langslow; *Rec. Sec.* Charles S. Cook. Meetings held at room 35, Powers' buildings, every Thursday evening. Semi-annual meetings first Thursday in April and October.

Mutual Loan Association.—Organized 1872. Capital \$125,000. *Pres.* Ambrose Cram; *Vice Pres.* Wm. A. Wilson; *Sec.* James M. Niven; *Treas.* Wm. F. Parry; *Atty.* George Truesdale. Meetings held every Monday evening at Jefferson House, Brown street. Annual meeting last Monday in February.

Ontario Street Savings and Aid Association.—Incorporated May 15th, 1872. Rooms Ontario street. *Pres.* Louis C. Cook; *Vice Pres.* George F. Smith; *Sec.* C. M. Meyer; *Treas.* John Penny. Stated meeting Wednesday evenings. Annual meeting first Wednesday in May.

Rochester Co-Operative Building Lot Association.—Organized 1869. Property comprises 48½ acres on North St. Paul street. *Pres.* Wm. L. Harris; *Rec. Sec.* Ed. B. May; *Fin. Sec.* Henry A. Langslow.

Rochester Flour City Savings and Aid Association.—Organized Sept. 14th, 1871. *Pres.* David J. Sadden; *Vice Pres.* W. T. Evans; *Sec.* John A. P. Walter; *Treas.* Geo. J. Oaks. Meets every Thursday evening.

Rochester German Sharpshooter Co-Operative Bldg. Lot Ass'n.—Organized 1872. Capital \$5,850. Property comprises 9¾ acres, located corner N. Clinton street and Ridge road. *Pres.* Sebastian Auer; *Sec.* Otto F. Werner; *Treas.* Albert Schoen. Meetings held last Tuesday of each month at No. 67 Front street. Annual meeting last Tuesday in December.

Rochester Saving Aid and Loan Association.—Organized 1870. Capital \$125,000. *Pres.* George Frauenberger; *Vice Pres.* Wm. Wagner; *Treas.* John C. Koesterer; *Fin. Sec.* Charles Meng jr.; *Rec. Sec.* M. V. Wolf. Meetings held every Tuesday at Schlitzer's Hall. Annual meeting first Tuesday in April.

Rochester Shooting Park Association.—Organized 1874. Capital \$10,000. Property located corner North Clinton street and Ridge road, Irondequoit. No. of acres 5¼. *Officers:* *Pres.* Frank Fritzsche; *Treas.* Charles Engler. Meetings held every Wednesday evening at corner North Water and Andrews streets.

Strasbourg Building Association.—Organized 1873. Capital \$7,000. Property divided into 35 lots and located in Ward 15. *Pres.* Arthur A. Smith; *Vice Pres.* Lewis Curtis; *Sec.* John Spengler; *Treas.* Henry Hetzel; *Atty.* C. S. Baker. Meeting held every Tuesday evening at corner Kent and Erie streets. Annual meeting last Tuesday in July.

Teutonia Aid and Savings Society.—*Pres.* V. Dengler; *Vice Pres.* M. Marx; *Sec.* August Drees; *Treas.* V. Fleckenstein.

Twelfth Ward Saving and Loan Association.—Organized 1872. Capital \$131,250. *Pres.* V. F. Whitmore; *Vice Pres.* David Abeles; *Fin. Sec.* A. J. Reibling; *Rec. Sec.* Alfred Shone; *Treas.* Jacob Sauer. Meetings held at Florack Hall, Grand street, every Wednesday evening. Annual meeting on the second Wednesday in February.

Washington Aid and Loan Association.—Organized 1871. *Pres.* J. Schutte; *Sec.* S. Guggenheimer; *Treas.* L. A. Schlitzer. Capital \$25,000. Meet Thursday's at Schlitzer's Hall. Annual meeting first Thursday in March.

West Avenue Building Lot Ass'n.—Organized '72. Cap. \$25,000. Property comprises 43 acres, located on Thurston road, Ward 15. *Pres.* Malcolm Fletcher; *Vice Pres.* Hugh Annett; *Rec. Sec.* James F. Casey; *Fin. Sec.* A. S. Bostwick; *Treas.* H. K. Van Tyne; *Atty.* J. A. McGorray; *Trustees,* Wm. Bingham, Robert Bingham, Robert Patterson, Michael Duffy, Robert Morgan. Meetings held every Monday evening at corner West avenue and Prospect. Annual meeting third Monday in January.

MASONIC.

Valley Lodge, No. 109.—*W. M.*, H. J. Durgin; *Sec.* C. C. Gifford. Stated communications every Monday evening, in Masonic Temple, 14 Exchange street.

Yonondio Lodge, No. 163.—*W. M.*, Thos. L. Turner; *Sec.* J. T. Southard. Stated communications Tuesday evenings, in Masonic Temple, 14 Exchange street.

Genesee Falls Lodge, No. 507.—*W. M.*, W. Liddell; *Sec.* J. L. Townsend. Stated communications every Wednesday evening, in Masonic Temple, Exchange street.

Rochester Lodge, No. 660.—*W. M.*, E. B. Chapin; *Sec.* B. Frank Enos. Stated meetings every Monday evening, in Daily Union buildings, 82 West Main street.

Germania Lodge, No. —*W. M.*, J. George Baetzel; *Sec.* John Neun. Meets every Wednesday evening, at 82 West Main street.

Hamilton Chapter, No. 62.—ROYAL ARCH MASONS.—*H. P.*, J. W. Merriam, jr.; *Sec.* John Alexander. Meets every Thursday evening, in Masonic Temple, Exchange street.

Ionic Chapter, No. 210.—*R. D.*, ROYAL ARCH MASONS.—*H. P.*, E. A. Loder; *Sec.* Owen Williams. Stated meetings every Friday evening, at 82 West Main street.

Doric Council, No. 19.—ROYAL AND SELECT MASTERS.—*T. I. M.*, Thos. Seed; *Rec.* J. Alexander. Stated assemblies alternate Wednesday evenings, in Masonic Temple, Exchange street.

Monroe Commandery, No. 12.—*E. C.*, W. Lincoln Sage; *Rec.* W. J. McKelvey. Stated conclaves every Friday evening, at Masonic Temple, Exchange street.

Cyrene Commandery, No. 39.—*E. C.*, A. J. Hatch; *Rec.* C. M. St. John. Stated conclaves every Tuesday evening, in Daily Union buildings, 82 West Main street.

Rochester Grand Lodge of Perfection.—*T. P.*, W. H. Whiting; *Sec.* John Alexander. Meets Monday evenings.

Rochester German Lodge Perfection.—Organized June 17th, 1873. *T. P. G. M.*, August M. Koeth. Meets every Tuesday evening at 14 State street.

Rochester Council P. of J.—*M. E.*, Courtland Avery; *Sec.* Owen Williams. Meets semi-monthly—Mondays, at 14 State street.

Rochester Chapter Rose Croix.—*M. W. and E. M.*, Rev. Asa Saxe; *M. E. K.*, *Sec.* John Alexander. Meets monthly—Mondays, at 14 State street.

Genesee Temple, No. 2.—ARABIC ORDER NOBLES OF THE MYSTIC SHRINE.—*G. P.*, Wm. Shelp; *Scribe*, Wm. Davis. Meets over 14 and 16 State street, every Wednesday.

Rochester Gr. Consistory.—*Com'd-in-Chief*, Otis Cole; *Sec.* Owen Williams. Meets monthly—Mondays at 14 State street.

Excelsior Conclave, No. 1, of N.Y. State, European Knighthood.—Meets in Consistory Hall, Saturday evenings.

Eusebius Conclave, No. 9, Red Cross Knights of Rome and Constantine.—*Sov.* W. H. Whiting; *Rec.* Owen Williams. Meets in Consistory Hall, 14 State street.

Western New York Masonic Relief Association.—Organized 1871. *Pres.* Wm. Roades; *Vice President*, J. G. Maurer; *Treas.* S. M. Benjamin; *Sec.* C. C. Gifford.

I. O. O. F.

Genesee Lodge No. 3.—Meets Friday evenings at Odd Fellows' Hall, 53 East Main street.

Teoronto Lodge No. 8.—Meets at Odd Fellows' Hall, 53 East Main street, Monday evenings. Teoronto Lodge Library and Reading Room, open every week day evening.

Rochester City Lodge No. 66.—Meets Tuesday evenings at Odd Fellows' Hall, 53 East Main street.

Humboldt Lodge, No. 138.—Meets Wednesday evening at Odd Fellows' Hall, 53 East Main street.

Orient Lodge No. 273.—Meets Monday evenings, at Odd Fellows' Temple, West Main street.

Floral Lodge No. 281.—Meets Wednesday evenings at No. 44 State street.

Koerner Lodge No. 288.—Meets Tuesday evenings, Keeler block, 54 E. Main street.

HENRY C. WISNER,

THE CELEBRATED Sole Agency "MOSELLE WARE"—No. 33 STATE STREET.

John G. Klinck Lodge No. 378.—Meets Tuesday evenings at No. 44 State street.

Temple Lodge No. 412.—Meets Tuesday evenings at Odd Fellows' Temple, West Main street.

Mt. Hope Encampment No. 2.—Meets at Odd Fellows' Hall, 53 East Main street, the 1st and 3d Thursday each month.

Glide Encampment No. 75.—Meets 1st and 3d Monday evenings of each month at No. 44 State street.

King Solomon Encampment No. 82.—Meets at Odd Fellows' Temple, West Main street, 1st and 3d Thursday evenings of each month.

Monroe Degree Lodge No. 12.—Meets at Odd Fellows' Hall, the 2d Thursday of each month.

Rochester Degree Lodge No. 36.—Meets at Odd Fellows' Temple, the 4th Thursday of each month.

Monroe Rebekah Lodge No. 1.—Meets at Odd Fellows' Hall, the 4th Thursday of each month.

Grace Rebekah Degree Lodge No. 54.—Meets at Odd Fellows' Temple, every 2d Thursday evening.

Mutual Aid Society.—Meets at Odd Fellows' Hall, the 2d Tuesday of each month.

Odd Fellows' Protective Union for Widows and Orphans.—Meets at Odd Fellows' Temple, every 1st and 3d Friday evening of each month.

HARUGARI.

Brudertrue Lodge No. 95.—Organized 1862. Meets at hall East Main corner Stone street, every other Wednesday evening.

Saxonia Lodge No. 270.—Organized 1872. Meets every other Monday evening.

Schiller Lodge No. 74.—Organized 1859. Meets every Friday evening.

Herta Lodge No. 23.—Organized 1862. Meets every Tuesday evening.

Walliroth Lodge No. 313.—Organized 1873. Meets first and third Thursday in each month.

KNIGHTS OF PYTHIAS.

Aurora Grata Lodge No. 39.—Meets every other Friday evening at Metropolitan block, East Main corner South St. Paul.

Bleucher Lodge No. 93.—Meets Monday evenings, at Metropolitan

block, East Main corner South St. Paul.

Genesee Lodge No. 94.—Meets Tuesday evenings at Masonic Temple, 14 Exchange street.

TEMPERANCE SOCIETIES.

Rochester Women's Temperance Society.—Organized January, 1876. *Pres.* Mrs. M. L. Farrar; *Sec.* Miss R. B. Long. Meets every other Monday afternoon at the Dining Rooms, No. 89 State street.

Women's Christian Temperance Union.—Organized November, 1875. *Pres.* Miss R. B. Long; *Vice Pres.* Mrs. D. M. Anthony; *Sec.* Mrs. Mary Hen-

kle; *Treas.* Miss Elizabeth McKay; *Supt.* Mrs. R. M. Olin. Meets second Monday of each month. Dining rooms at 8 East Main street.

St. Mary's Temperance Cadets.—Organized March 17, 1873. *Pres.* Patrick Kearney; *Vice Pres.* Wm. Kavanah; *Treas.* Chas. Quinn; *Sec.* Fred. Madden. Meets first Sunday of each month.

I. O. G. T.

Calypso Degree Temple No. 36.—Instituted February 6th, 1867. Meets at Good Templars' Hall.

Excelsior Lodge No. 79.—Instituted August, 1866. *W. C. T.*, E. M. White; *Sec.* W. C. Woodward. Meets every Monday evening at Good Templars' Hall, East Main street corner Stone.

Monroe County Lodge.—*C. C. T.* W., Martin Jones; *C. S.*, S. D. Richardson; *C. V. T.*, Mrs. Sperry. Meets quarterly. Officers elected annually.

Washington Lodge No. 311.—Instituted June, 1867. *J. D. W.*, Martin Jones; *W. C. T.*, William T. Logan; *W. V. T.*, Miss Dopler. Meets every Thursday evening, at 44 State street.

ROCHESTER POST OFFICE.

Established in 1812.

POST OFFICE IN THE ARCADE.

Postmaster.—DANIEL T. HUNT.

Assistant.—W. S. Whittlesey.

Chief Clerk.—Calvin Wait.

Money Order Clerks.—W. G. Mitchell, W. F. Peck,

Stamp Delivery Clerk.—Jacob G. Maurer.

Local Agents.—Eli Weed, Nicholas Hadley.

Clerks.—Byron D. Wilson, William Walker, Geo. F. Loder, Edward Pond, John McKelvey, Louis Krause, Charles H. Davis, S. M. Luckey, C. F. Weissinger, Herbert Huson, C. H. Billings, John Wright, Jr.

Superintendent of Carriers.—G. A. Begy.

Carriers.—William H. James, John Van Male, J. C. Chase, W. A. Shepherd, Wm. H. Jenkinson, John Buchmiller, Wm. Pelling, Clarence B. Strong, E. H. Warren, W. H. Dana, T. A. Evans Wm. Qualtrough, F. E. Scrantom, A. F. Bingemer, F. A. Hills, Fred. H. Hebard, J. H. Moore, Edward Heller, R. B. Dixon, R. Charles Reynell, W. S. Bradt, B. E. Moran, John H. Ruby.

The office is open from 7½ A. M. to 7 P. M., throughout the year. On Sundays, from 11½ A. M. to 12½ P. M., city time. **MAILS CLOSE BY RAILROAD TIME.** All Sunday mails close at 4.30 P. M.

CLOSING OF MAILS.

The mail arrangements given below are subject to but few changes during the year.

Postal Car (east).....	6.30	A. M.
Canandaigua and Elmira Agent.....	6.30	"
Northern Central R. P. O.....	6.30	"
Lake Ontario Shore Agent.....	6.30	"
Canandaigua, Brighton and Charlotte.....	6.30	"
Valley R. R. (way).....	8.10	"
Rochester and Dansville Agent.....	8.10	"
Niagara Falls Postal Car.....	9.25	"
Buffalo and Batavia.....	9.25	"
Albany and Syracuse.....	9.05	"
Fast Line West.....	12.15	P. M.
Fast Line East.....	2.15	"
Auburn R. R. Agent.....	2.15	"
Brighton.....	2.15	"
All Stage Mails.....	2.15	"
Erie R. R. Postal Car and Charlotte.....	3.00	"
Brockport, Spencerport, Albion and Medina.....	3.00	"
Avon and Buffalo Agent.....	3.30	"
Scottsville, West Henrietta, North Rush, Dansville, Lima, Gene- seo, Mt. Morris and Avon.....	3.30	"
New York, Albany, Albany & Boston Postal Car.....	4.30	"
Philadelphia, Baltimore and Washington.....	4.30	"
Detroit, Michigan Central Agent.....	4.30	"
Lockport, Suspension Bridge, Detroit and Milwaukee Agent.....	8.00	"
Postal Car (west).....	8.00	"
New York, Albany and Syracuse.....	8.00	"
Seneca Falls, Waterloo, Auburn and Geneva.....	8.00	"

STAGE MAILS.

West Webster, Penfield, East Penfield, Henrietta, East Rush, Brighton, Greece, West and North Greece, Hanford's Landing, Clifton, Gates and Chili—close at 2 P. M., and arrive at 10.30 A. M.

CARRIERS' FREE DELIVERY.

Mail matter is delivered daily by carriers, between the hours of 7.30 A. M. and 6 P. M.; in the business portions of the city five times; in the intermediate portions, three times, and in the outer portions, once. No delivery by carriers on Sunday, but letters can be called for at the Post Office from 11.45 A. M. to 12.45 P. M.

RECEIVING BOXES.

Iron boxes for the reception of letters, *prepaid by stamps, according to law*, have been placed on most of the public buildings, hotels, and at the corners of the principal streets.

HENRY C. WISNER,

*WHITE CHINA DINING and TEA SETS,
No. 33 STATE STREET.*

Letters are collected from these boxes daily, except Sunday, between 6 A. M. and 6 P. M.; in the business portions of the city, five times; in the intermediate portions, twice, and in outer portions once.

Letters to be registered must be taken to the Post Office.

The streets of Rochester have been declared post routes by the Postmaster-General, to the exclusion of all unauthorized letter carriers.

VALUABLE LETTERS

Should invariably be taken to the Post Office and registered. The registry fee to all parts of the United States is 10 cents; Canada, Great Britain and the German States, 10 cents.

"Special Request"—stamped envelopes: when ordered in quantities of 500 and upward, the Department will, if desired, print on the upper left hand corner, without additional charge, the name and Post Office address of parties with request to return if unclaimed within a given time. Stamped envelopes spoiled in directing will be redeemed at their postal value.

MONEY ORDERS.

RATES OF COMMISSION CHARGED FOR MONEY ORDERS.

On Orders not exceeding \$15.....	10 cents.
Over \$15 and not exceeding \$30.....	15 "
" \$30 " " \$40.....	20 "
" \$40 " " \$50.....	25 "

INTERNATIONAL MONEY ORDERS.

International Money Orders issued at this office on Post Offices in all parts of Great Britain and Ireland, the German States and Switzerland.

RATES OF COMMISSION.

On Orders not exceeding \$10.....	25 cents.
Over \$10, and not exceeding \$20.....	50 "
" \$20, " " \$30.....	75 "
" \$30, " " \$40.....	\$1.00
" \$40, " " \$50.....	\$1.25

List of Money Order Offices may be seen at the Post Office.

The Post Office Department having provided perfectly safe means for the transmission of small sums of money by mail, the public are advised never to enclose money in an ordinary letter, but in all cases to remit by money order or registered letter.

RATES OF POSTAGE.

FIRST CLASS.

On letters, sealed packages, mail matter, wholly or partly in writing (except book manuscripts and corrected proof-sheets passing between authors and publishers, and except local or "drop" letters); on all printed matter so marked as to convey any other or further information than is conveyed by the original print (except the correction of typographical errors); on all matter not otherwise chargeable with letter postage, but which is so wrapped or secured that it cannot be conveniently examined by postmasters without destroying the wrapper or envelope; and on all packages of matter not in itself chargeable with letter postage, but in which is inclosed or concealed any letter or other thing chargeable with letter postage—3 cents for each half ounce or fraction thereof—weight of packages limited to four pounds.

On local or "drop" letters, at offices where free delivery by carriers is established—2 cents for each half ounce or fraction thereof—weight of packages limited to four pounds.

THIRD CLASS.

[NOTE.—Packages of mailable matter of this class must be prepaid by stamps, and must not exceed the weight prescribed by law (which is four pounds). Packages exceeding the prescribed weight are unmailable.]

All matter of the third class must be fully prepaid, viz.:

On pamphlets, occasional publications, transient newspapers, magazines and periodicals; hand-bills, posters, sheet-music, unsealed circulars, prospectuses, book manuscripts and proof-sheets, printed cards, maps, lithographs, prints, chromo-lithographs and engravings, seeds, cuttings, bulbs, roots and scions, books, flexible patterns, samples of ores, metals, minerals and merchandise, sample cards, phonographic paper, letter envelopes, postal envelopes and wrappers, unprinted cards, plain and ornamental paper, photographs, and all other articles for which other rates of postage are not prescribed in this table, and

which are not by law excluded from the mails—1 cent for each ounce or fraction thereof—weight of packages limited to *four pounds*.

Unsealed circulars, newspapers (whether transient or addressed to regular subscribers)—excepting *weekly* papers, which may be delivered to subscribers on prepayment of regular rates (2 cents per pound), and on periodicals not exceeding two ounces in weight, when any of the same are deposited in a letter carrier office for delivery by the office or its carriers—1 cent each.

Periodicals exceeding two ounces in weight, when deposited in a letter carrier office for delivery by the office or its carriers—2 cents each.

The following articles are EXCLUDED FROM THE MAILS: Liquids, Poisons, Glass, Explosive Materials, Books, Pamphlets, Pictures and other publications of an obscene or indecent character; all letters upon the envelopes of which, and postal cards upon which, scurrilous epithets are written or printed or engraved, or disloyal devices printed or engraved; and all articles which from their form or nature are liable to destroy, deface or injure the contents of mail bags or the person of any one engaged in the postal service.

POSTAL CARDS.

Postal cards are sold at 1 cent each.

They are to be regarded by postmasters the same as sealed letters, and not as printed matter, except that in no case will unclaimed cards be returned to the writer.

They are subject to the following rules:

After they are once delivered they cannot be re-mailed at less than letter rates of postage.

They can be forwarded from one office to another on the same terms as letters, viz: if they have not been delivered.

They must not have anything pasted, gummed, tied, or attached in any way to them. They must contain no writing or printing on the face or stamp side but the address

They must not bear any abusive, scurrilous or obscene matter.

They must not be redeemed by postmasters under any circumstances whatever. (sec. 398, Reg. 1873.)

They are not returnable to the writer, except by a new postage at letter rates.

Postal cards may be sent to Newfoundland, Switzerland and Germany, by the payment of additional postage of one cent on each card—to be prepaid by stamps. To Canada without further charge than the original stamp on the card.

POST OFFICES AND POST MASTERS IN MONROE COUNTY.

** Denotes Money Order Offices.*

Post Office.	Town.	Post Office.	Town.
Adams' Basin, Benj. T. Cady	Ogden	Mumford, J. McQueen	Wheatland
Barnard's Crossing, G. C. Lutes	Greece	North Chili, Marius O. Benjamine	Chili
Brighton, Ezra Rosebrough	Brighton	North Greece, W. T. Filer	Greece
*Brockport, Mrs. M. E. Baker	Sweden	North Hamlin, H. Hovey	Hamlin
Bushnell's Basin, James F. Lawrence	Perinton	North Parma, Chas. Efner	Parma
Charlotte, John M. Allen	Greece	North Rush, Henry B. Hart	Rush
Chili, John N. Wood	Chili	Ogden, Geo. G. True	Ogden
Churchville, T. W. Harford	Riga	Parma, Sylvester P. Tripp	Parma
Clarkson, Adams Moore	Clarkson	Parma Centre, W. McKinney, jr.	Parma
Clifton, Eleazer E. Howard	Chili	Penfield, Isaac Bronson	Penfield
Coldwater, Edwin B. Avery	Gates	Pittsford, Noyes L. Parsons	Pittsford
East Kendall (Orleans Co.), Andrew Clark	Kendall	Riga, Niles H. Outhout	Riga
East Penfield, R. W. Chase	Penfield	*Rochester, D. T. Hunt	Rochester
Egypt, Cullen Loud	Perinton	Rush, Benjamin L. Kinsey	Rush
*Fairport, M. R. Wilcox	Perinton	*Scottsville	Wheatland
Gates, Miles C. Tuttle	Gates	South Greece, John J. Servis	Greece
Greece, Peter Marrian	Greece	*Spencerport, Miss S. F. Lincoln	
Hamlin, Marcellus S. Crabb	Hamlin	Union Hill	Ogden
Henrietta, Thos. O. Jones	Henrietta	Webster, Jerome Jones	Webster
Honeoye Falls, R. Ostrander	Mendon	Webster, Safford F. Mason	Webster
Mendon, Smith Porter	Mendon	West Brighton, C. Meitzler	Brighton
Mendon Centre, A. D. Gazely	Mendon	West Greece, Henry Pulsis	Greece
Mt. Read, Jas. Fleming	Greece	W. Henrietta, M. Williams	Henrietta
		West Rush, John B. Bristol	Rush
		West Webster, C. Goetzmann	Webster

HENRY C. WISNER,

**REAL AND FRENCH BRONZES,
No. 33 STATE STREET.**

PENAL ORDINANCES OF THE CITY OF ROCHESTER,

CHAPTER I.

RELATING TO NUISANCES.

Passed November 11th, 1862.

The Common Council of the City of Rochester do ordain as follows :

SECTION 1. No person shall make, aid, countenance, or assist in making any **noise, disturbance**, or improper diversion in any of the streets, public squares, lanes or alleys, in the city of Rochester, nor shall any assemblage or crowd of persons collect in such streets, public squares, lanes or alleys, or on any of the bridges, to the annoyance or disturbance of any of the citizens or others, under a penalty of TEN DOLLARS for each offence.

No person shall sound any **gong** in the street, or in any alley, upon any sidewalk, or upon any piazza, balcony steps or platform, adjoining any sidewalk or street in the city of Rochester, under a penalty of TEN DOLLARS for each offence.

No tenant or occupant of any dwelling shall suffer or permit any **gong** to be sounded upon any street, alley or sidewalk, or upon any piazza, balcony, stoop, step or platform, adjoining any street or sidewalk in said city, under a penalty of TEN DOLLARS for each offence.

§ 2. No person shall **drive or ride**, or cause or suffer to be rode or driven, any horse, mare, gelding or other animal, in or through any public street, lane or alley of said city, at a speed exceeding six miles an hour, under a penalty of TEN DOLLARS for each offence.

§ 3. No person or persons shall **ride or drive**, or cause to be rode or driven, any horse, mare, gelding or other animal, upon or over any of the bridges within said city, except Main and Buffalo street bridge ; or over the cross-walk at any corner of a street, lane or alley, faster than a walk, under a penalty of FIVE DOLLARS for each offence.

§ 4. No person shall leave any horse, mare, gelding or other animal standing in any public street or alley, within said city, without being well secured, **tied or fastened**, under a penalty of FIVE DOLLARS for each offence.

§ 5. No person shall throw or deposit any straw, shavings, lime, ashes, refuse coal, scraps, slops, **dirt or rubbish** of any description, or the contents of any bed, into or upon any street, park, lane or alley in the said city, under a penalty of TWO DOLLARS for each offence.

§ 6. No person shall deposit, or cause to be deposited, any dead animal, fish, or putrid meat, entrails, shells of oysters or clams, decayed fruit or vegetables, or any other filthy or **offensive substance**, in or upon any **public street**, lane, park or alley, or on the surface of the ground in any lot, or in any canal, or any basin attached thereto, or in the Genesee river except as hereinafter provided, or in any mill-race, or on any bank thereof in said city, or suffer or permit any stagnant or filthy water, or putrid or unwholesome meats, decayed fruits or vegetables, or other filthy or offensive substance, to remain on his or her lot, or in his or her house, or other building or cellar, or in or upon any boat in any canal, or in the Genesee river, within the limits of this city, under a penalty of TWENTY-FIVE DOLLARS for each offence, and the expense and charge which the said corporation shall incur in removing or abating such nuisance.

The police Justice, or any Alderman, Superintendent of Streets, or any person authorized by them, or either of them, or any policeman, may at any time enter into or upon any house, cellar, boat, lot or other place, and remove or abate such **nuisance** in such manner as shall be judged best. And every person obstructing or hindering such removal or abatement shall forfeit and pay a penalty of TWENTY-FIVE DOLLARS for each offence.

§ 7. No person shall fly a **kite** within the said city under a penalty of TWO DOLLARS for each offence.

§ 8. No person shall, under a penalty of TWENTY-FIVE DOLLARS for each offence, sell, or keep, or expose for sale, any gunpowder, or India or China, or other fire crackers, rockets, or other preparations from **gunpowder**, without **license** therefor from the common council. And the Mayor of said city, or any Alderman, or the City Superintendent, is hereby authorized to enter upon the premises where the same are kept, and to seize or destroy or otherwise dispose of the same.

§ 9. No person shall fire or set off any gunpowder, cracker, squib or rocket, or **firework**, or fire any pistol, gun or cannon, or throw any fire ball, or make any bon-fire, or aid or abet therein, in any part of the said city, under a penalty

of FIVE DOLLARS for each offence. But this section may be suspended in any particular and as to any person, in the discretion of the Mayor.

§ 10. No person shall cast or throw any **hide or skin**, tanned or not tanned, out of any door or window of any building, above the first story, fronting on any street, or cause any such untanned hide to be suspended from, or laid on any post or elsewhere, in any street of such city, under a penalty of TWO DOLLARS for each offence.

§ 11. No person shall **bathe or swim** in any canal, basin, mill-race or river, within the limits of said city, between the hours of six in the morning and eight in the evening, nor at any time between the upper dam and Clarissa street bridge, or in the Erie canal between Meigs street bridge and the House of Refuge lot, under a penalty of TWO DOLLARS for each offence.

§ 12. No person shall keep a **nine-pin or bowling alley**, or billiard table, within said city, without a license therefor from the common council, under a penalty of TEN DOLLARS for each and every day the same shall be so kept.

§ 13. No person keeping an alley commonly called a **nine-pin alley, bowling alley or a billiard table**, within the city, shall permit any game to be played thereon after ten o'clock in the evening, or before eight o'clock in the morning; nor shall any such person suffer or permit any minor, or apprentice to play at said alley or table at any time whatever, under a penalty of FIVE DOLLARS for each offence.

§ 14. Any person who shall keep a **disorderly house**, or a gaming house, or a room or rooms within this city for either or both of these purposes, shall, upon conviction therefor, pay a penalty of not less than FIFTY DOLLARS.

Any person who shall have or keep a house, building or place in the city in which any e. o. table, keno table, faro bank, shuffle board, bagatelle, playing cards, or any instrument, device or thing employed for **gambling**, shall, by or with the consent or permission of such person, his agents or servants, be kept or used, whereon or with which money shall in any manner be played for, shall be subject to a fine of not less than FIFTY DOLLARS.

Any person who shall play for liquor, beer, cider, or other article, or permit the same to be played for, as above stated, shall be subject to a fine of not less than FIVE nor more than FIFTY DOLLARS.

Any owner or keeper, or any person within such disorderly or gambling house, room or rooms, building or place, who shall refuse to permit the Mayor, any Alderman, the Police Justice, Chief of Police, or any policeman to enter the same, or shall **obstruct or resist** the aforesaid officers (or persons summoned by them to assist) in entering such place, or in the **destruction of any instruments or devices** employed in gambling in such places, shall be subject to a fine of not less than TEN nor more than ONE HUNDRED DOLLARS.

§ 15. No person shall cut, **injure, deface or tarnish**, any public building, bridge, street sign, or any property belonging to the corporation; nor any well, pump, fence, tree, awning, useful or ornamental improvement, or public work in said city; nor break any window or window glass in any private or public building, or place of worship; nor aid, abet, or assist therein, under a penalty of TEN DOLLARS for each offence.

§ 16. No boat **bell** shall be rung, nor shall any **signal horn**, trumpet, or other instrument, be blown or played for a signal within said city on Sunday, nor shall any bell connected with or used for any railroad depot, be rung within said city on Sunday, under a penalty of FIVE DOLLARS for each offence.

§ 17. No person shall **post any bill or card** or advertisement on any building or fence in said city, without leave from the owner or occupant, nor upon any public bridge, under a penalty of FIVE DOLLARS for each offence.

No person shall carry, or procure to be carried, any sign, bill, card or advertisement for the purpose of advertising any business, profession, trade, place of amusement, or occupation, through or upon any of the streets or sidewalks of said city, under a penalty of FIVE DOLLARS for each offence.

§ 18. No person shall **solicit alms** within said city, without the written permission of the Mayor, nor after thirty days from the date of said permission, or the granting of the same, which written permission shall be presented and shown at the time of soliciting, under a penalty of TWO DOLLARS for the first offence, and FIVE DOLLARS for every subsequent offence.

§ 19. No runner, stage driver or other person, shall **solicit passengers** travelers, or other persons, in any of the public streets, railroad depots, or public places, or on any wharf, or on board of any boat or stage, within said city, for any railroad car, boat, stage or carriage, or for any public inn or tavern, under a penalty of FIVE DOLLARS for each offence.

§ 20. No owner or possessor of any swine, horses, sheep, goats, cows, or other **cattle**, shall suffer any such animal or animals to run or to be at large in any of the public streets, lanes, alleys, or parks within said city, under the penalty of ONE DOLLAR for each animal so running or being at large.

§ 21. No owner or possessor of any **goose** or **geese**, **ducks**, or other fowls, shall suffer any such fowl to run or to be at large in any of the public streets, lanes, alleys, or squares within said city, under a penalty of TWENTY-FIVE CENTS for each fowl, &c., so running or being at large.

§ 22. No **dog** shall be permitted to go abroad in any of the streets, squares, lanes, alleys or public places in this city, without being led and securely confined by a chain or string, or properly muzzled, under a penalty of TEN DOLLARS for each offence, to be recovered against the owner or possessor of such dog, or the person who harbored such dog within two days previous to the time of such dog being found so going abroad.

§ 23. No person shall **hinder** or molest any person or persons who may be engaged in lawfully seizing, shooting or **killing any dog** going abroad as aforesaid, or in removing the carcass thereof, under the penalty of TEN DOLLARS.

§ 24. No person or company of persons shall exhibit or perform for gain or profit, any **theatrical or circus** representations or exhibitions, or any paintings, animal or animals, or other natural or artificial curiosity, or any puppet show, wire or rope dance, or any other idle show, acts or feats which common showmen, mountebanks or jugglers usually practice or perform, or any concert, musical entertainments, exhibition or dances, or series of lectures for private emolument or gain, without having obtained a **license** for the same from the common council of said city; and no owner or occupant of any house, outhouse, yard or other place, shall furnish or allow the same to be used for the accommodation of such exhibition or performance, unless such license be obtained as aforesaid, under a penalty of FIFTY DOLLARS for each offence.

§ 25. The Mayor or other officers for the time being exercising the duties of the office of Mayor, may, whenever an application cannot in the first instance be made to the common council, grant **licenses** for public shows and exhibitions, on the payment into the treasury of such sums as the Mayor or said officer shall direct; such license to be valid until the next ensuing meeting of the common council.

§ 26. No person shall construct or cause to be constructed within the said city, any **vault** to be used for the purpose of a **privy**, without special permission from the board of health, Mayor, or Health Physician, under a penalty of FIFTY DOLLARS for each offence.

§ 27. Every resident owner of every inhabited lot in said city, and the occupant of every such lot, when the owner thereof is a non-resident, shall provide and keep upon such lot a convenient **privy**, with a vault at least four feet deep, under a penalty of FIVE DOLLARS for every twenty-four hours any violation of this ordinance shall be continued.

§ 28. All owners and keepers of **hotels, taverns**, boarding houses, factories, arcades, warehouses and establishments where more than ten persons are habitually gathered or employed, within the said city, shall cause to be constructed on their respective premises, one or more strong wooden boxes, slides or drawers, of suitable dimensions, provided with a convenient handle at each end, and with moveable lids, which may be fitted thereto perfectly tight; and shall cause such boxes to be placed under the seats of their respective privies, as a substitute for vaults now in use; and shall cause such boxes to be carried away and emptied by licensed scavengers, into places to be designated by the Mayor or board of health, and washed out perfectly clean, and again replaced at least once in each week, from the first day of May to the first day of October in each year, or oftener, as the board of health shall direct, under a penalty of FIFTY DOLLARS for each offence.

§ 29. No person shall, under the penalty of FIFTY DOLLARS for each offence, empty or deposit the contents of any tub or receptacle out of any privy, vault or cess pool into any street, alley, canal or public square, or into the river, except at places designated therefor by the Mayor or board of health.

§ 30. No person shall build or cause to be built, a **privy** on or near the **bank of any canal**, or on or near the bank of any basin or slip, within said city, in such manner as that the same shall communicate with said canal, basin or slip; and all owners and occupants of privies already built in such manner, shall not use such privies except with boxes, slides or drawers, as described in the twenty-eighth section of this ordinance, under a penalty of FIFTY DOLLARS for each offence.

Nothing herein contained shall apply in any manner to any privy, the contents of which are carried into any sewer of ample dimensions, and washed out by a suitable supply of water.

§ 31. It shall be the duty of the **City Superintendent**, or such other person as may be specially authorized for that purpose by the board of health (and such Superintendent or person so authorized shall have power) to enter into and upon, and **examine** any lot, yard, building, cellar, alley, basin, slip, sink, drain, vault or privy, or any other place within the limits of the said city of Rochester; and if the same shall be found to be foul, incumbered with rubbish, damp, sunken or ill-constructed, or to contain any filth or other offensive substance or nuisance, to direct the removal of all such nuisance, filth, other offensive substance, or the cleansing or repairing of any drain, vault or privy, upon any such lot of ground or premises, by the owner or agent of the owner, lessor, lessee, or occupant of the same, within twenty-four hours after such directions from such Superintendents or other person. Any person who shall refuse or neglect to comply with such directions, after such notice as aforesaid, shall forfeit and pay a penalty of **TWENTY-FIVE DOLLARS** for each offense.

§ 32. No person shall place or post, or cause or permit to be placed or posted, in any street or on any bridge, in said city, any **handbill or advertisement** giving notice that any person has, or professes to have skill in the treatment or curing of any disorders, **disease**, or giving notice of the sale or exposure to sale of any nostrum or medicine, under the penalty of **TEN DOLLARS** for each offense.

§ 33. The Mayor may from time to time license such and so many persons as he shall deem proper, who shall be the **scavengers** of said city, whose licenses shall expire on the first day of July next, after the same shall be granted.

Such scavengers shall execute a bond to the city of Rochester in the penalty of two hundred and fifty dollars for the faithful performance of their duty and under the regulations prescribed by the board of health.

From and after the first day of July, 1876, the contents of any privy vault, box, drawer, or cess pool, shall not be removed except in air and water-tight receptacles, and in the manner and by such apparatus as shall be prescribed by the board of health of the city of Rochester, under a penalty of **TWENTY-FIVE DOLLARS** for each offense.

§ 34. Every execution issued upon a judgment recovered for a **violation** of any and all of the preceding sections of the **ordinance**, shall command the amount to be made of the property of the defendant, if any such can be found, and if not, then to commit the defendant to the Monroe county penitentiary for the period of not less than **TEN** nor more than **THIRTY DAYS**.

§ 35. Any person who shall be guilty of keeping or maintaining, or be an inmate of, or in any way connected with, or any way contribute to the support of any disorderly house or **house of ill-fame**, or place for the practice of fornication, or knowingly own or be interested as proprietor or landlord of any such house, shall, on conviction for the same, be liable to be fined in any sum not exceeding **ONE HUNDRED DOLLARS**, and in default of payment of the penalty imposed, shall be imprisoned in the Monroe county penitentiary, or county jail, for any period not exceeding **ONE HUNDRED AND THIRTY DAYS**.

§ 36. Any female who shall be convicted of being an inmate of any house of ill-fame, or place for the practice of fornication, or shall be found loitering or strolling about the streets of the city, by day or night, without any regular, lawful business, or who shall be convicted of being a prostitute, shall be subject to a penalty in a sum of money of not less than **TEN** nor more than **FIFTY DOLLARS**, and in default of payment or recovery of such penalty imposed, shall be subject to imprisonment in the Monroe county penitentiary for a term not exceeding **THREE MONTHS**.

§ 37. The Mayor, Police Justice, Chief of Police, any alderman or policeman or persons summoned by them, or by any of them, to aid them, may enter any disorderly house, **house of ill-fame**, house of prostitution or assignation, or **gambling house** or room, and arrest, with or without a warrant, any suspicious persons found therein, and destroy any instruments or devices employed in gaming in such places; and if admission be refused, may enter by force, by breaking the doors or otherwise.

§ 38. Any person who shall, within the city, appear in a state of nudity, or in a dress not belonging to his or her sex, or in an **indecent** or lewd dress, or make an indecent exposure of his or her person, or shall sell, or offer to sell, any indecent or lewd book, picture or other thing, or shall exhibit or perform any indecent or immoral play, or other representation, shall be subject to a fine of not less than **FIFTEEN DOLLARS**, and in default of the payment of the

penalty or fine imposed, shall be subject to such term of imprisonment in the Monroe county penitentiary, not exceeding **THREE MONTHS**, as the magistrate shall deem proper.

§ 39. Any person who shall be drunk, or shall be in a state of **intoxication**, in any highway, street, alley or public place in the city, or in any private house or place, to the annoyance of any person or citizens, shall be liable to a fine not exceeding **TEN DOLLARS**, and in default of the payment of the fine or penalty imposed, shall be subject to imprisonment in the penitentiary not less than **TEN DAYS** nor more than **THREE MONTHS**.

§ 40. No person or persons, without the permission of the owner, shall molest, **drive away** or take from any of the public streets of the city of Rochester any **horse, mare**, or gelding belonging to another person; and any person or persons who shall so molest, drive away, take or use any horse, mare or gelding, shall, upon conviction, be sentenced to the Monroe county penitentiary for a period of not less than **THIRTY DAYS**.

§ 41. No person shall carry on, within the city of Rochester, any business or **manufactory** of such a character, or in such a manner, as shall produce or cause such a dense smoke, or such loud and disturbing noises as to be a nuisance; nor shall any person in the process of any **manufactory** or business, or in any manner cause to be set afloat in the air, or scattered and deposited upon any houses or lands within the city, cinders or soot so as to be a nuisance; and no person shall carry on any **manufactory** or business in said city, of such character, or in such a manner as shall cause or produce disturbing noises in any of the streets of the city. Every person who shall violate or offend against any provision of this section, shall forfeit and pay a penalty of **FIFTY DOLLARS**, and the further penalty of **FIFTY DOLLARS** for every day that such offense shall continue after notice from any city officer, to the offender to discontinue the same; but every **manufactory** or business already established, and now actually in operation or carried on, shall be excepted from the operation of this act.

§ 42. Every execution issued upon a judgment recovered for a violation of this ordinance, or any provision thereof, except as herein otherwise provided, shall command the amount to be made of the property of the defendant, if any such can be found, and if not, then to commit the defendant to the Monroe county penitentiary for a period not exceeding **TWENTY DAYS**.

CHAPTER II.

FIRES AND THE FIRE DEPARTMENT.

Passed November 14th, 1866.

The Common Council of the City of Rochester do ordain and determine as follows:

SECTION 1. The fire department shall be **organized** by the common council, and shall consist of one Chief Engineer, two or more Assistant Engineers, not more than four, one Fire Marshal, all of whom shall be appointed by the common council in the manner prescribed by the charter of the said city; and such number of steam fire engine companies, hook and ladder companies, hose companies, and sack and bucket companies, as the common council shall determine.

§ 2. The committee of the common council on fire department shall have the power, and it shall be **their duty** to appoint the engineers, drivers, foremen and hosemen of the several steam fire engine companies, the foremen, tillermen, drivers and hook and ladder men of the hook and ladder companies; to determine the number of men to be appointed to each of such companies, but the rate or compensation for their services shall be fixed by the common council.

§ 3. The committee on fire department shall prepare **proper rules** for the government of the fire department, and of each officer and member thereof; shall cause said rules to be posted in each engine and carriage house and in the hose depot, and shall furnish each officer and member of the department with a copy of said rules; and the committee shall have the power to discharge any member of the department (officers appointed by the common council excepted), for incompetency, neglect of duty, or for any violation of this ordinance, or of the rules or regulations provided for in this section.

§ 4. It shall be the duty of the Chief Engineer, whenever a fire shall occur in the city, to repair immediately to such fire, and to so use the fire apparatus and direct the efforts and labor of the firemen, as to extinguish the fire with the least possible damage; and he shall have the entire control and direction of the fire department at all fires occurring in the city, until such fires shall be extinguished or the department dismissed by his order.

A. R. PRITCHARD & LIKLY,

Trunks and Bags, Wholesale and Retail, No. 78 State Street.

§ 5. The **Chief Engineer** shall have charge of all the public cisterns, reservoirs, of the water pipes laid from the Erie canal and the upper mill race to furnish water for fires, and shall report to the committee on fire department any damage which may be sustained by any such reservoirs or water pipes. He shall, under direction of the committee on fire department, have charge of all buildings, apparatus, tools and other property belonging to the department; shall see that all the property is maintained in good condition, and that the fire apparatus is kept in repair, and ready for immediate duty. The committee on fire department shall furnish such supplies as may be necessary for the use of the department, and shall see that all supplies and material purchased or furnished by the committee are properly and economically used. The Assistant Engineers shall attend all fires in the city, and report to the Chief Engineer for duty; they shall obey the orders of the Chief Engineer, and remain at the fire until dismissed by him. The Assistant Engineer arriving first at any fire shall, in the absence of the Chief Engineer, and until his arrival, act as Chief, with all the powers and duties of that officer.

§ 6. All officers and members of the fire department shall be distinguished at fires by such appropriate equipage or **badge** as may be designated or approved by the committee on fire department.

§ 7. Upon the occurrence of any fire, it shall be the **duty** of the **policeman** on duty to cause the city hall bell to be rung, and a sufficient and reliable alarm to be given as rapidly as possible, and it shall be the duty of the **messenger** of the common council and the night watchman in the city hall to ring the alarm bell in cases of actual fire, for a period of not less than fifteen minutes. The bells of such churches as may be designated by the committee on fire department shall also be rung at least fifteen minutes, unless the alarm shall sooner be ascertained to be false.

§ 8. No person other than a city officer shall remove any cover from or do any damage to any public **reservoir or water pipe**, under the penalty of **FIVE DOLLARS** for each offence, besides damages which may ensue.

§ 9. No person shall take any water from any public reservoir, or shall **tap any water pipe** leading to such reservoir, except by permission of the common council, under the penalty of **TWENTY-FIVE DOLLARS** for each offence.

§ 10. All persons who may be present at any fire shall obey the orders of the Mayor or alderman and the officers of the fire department, in the extinguishment of the fire and the removal of property. Any person who shall neglect or refuse to obey such orders shall forfeit and pay the sum of five dollars for each offence.

§ 11. Any person or persons who shall enter any place where steam engines, hose or other fire apparatus shall be kept, with intent to injure the same, or who shall **injure any such engine, hose** or other fire apparatus, or shall remove any portion thereof, or otherwise mutilate or disable the same, or who shall do any damage to any engine house or other place where fire apparatus is kept or stored, or to any articles or fixtures, furniture or ornament in or about any such house or place, or who shall remove from any engine or carriage house, any engine, hose carriage, or other fire apparatus, without permission from the Chief Engineer, or an Assistant Engineer, shall forfeit and pay a penalty of **FIFTY DOLLARS**.

§ 12. No person shall use any lighted **candle, lamp** or torch, in any stable or other place or building where hay, straw or other combustible materials shall be kept or deposited, unless such candle, lamp or torch shall be properly secured in a lantern or other cover; nor shall any person enter or be in any such place with any lighted cigar or pipe, under a penalty of **FIVE DOLLARS** for each offence.

§ 13. No unslacked **lime** shall be deposited nearer than twenty feet to any building situated within the district defined in section one of "An ordinance relating to the erection and removal of buildings," nor shall any wooden spittoon, or **spittoon** of any kind filled with sawdust, be used in any room or building of said city; nor shall any ashes be put, deposited or kept in any vessel or receptacle made wholly or in part of wood. Any person offending against any of the provisions of this section shall forfeit and pay a penalty of **FIVE DOLLARS**, and the further penalty of **THREE DOLLARS** for every period of twenty-four hours that such offence shall be continued, and it shall be lawful for the Fire Marshal or Chief Engineer, or any alderman, to cause any such lime or ashes to be removed to a place of safety at the expense of the owner thereof, or the person depositing the same, to be collected by an action brought in the name of the city of Rochester before any court of competent jurisdiction, by the City Attorney.

§ 14. No person shall burn or cause to be burnt, or aid or assist in burning any hay, straw, chips, shavings, or other **combustible material**, in any street or alley within the district mentioned in section thirteen, without having first obtained permission to do so from the Mayor, Fire Marshal or Chief Engineer; nor shall any person make or cause to be made, any fire in any yard or premises within the said district, except it be within a building, without first having obtained permission as aforesaid. Any person offending against either of the provisions of this section shall forfeit and pay a penalty of **TEN DOLLARS** for each offence.

§ 15. Every carpenter, joiner, or other mechanic, or persons having a shop where chips, **shavings**, sawdust, or other combustible material may be produced or contained, shall clear and remove such material out of his shop or building and the yard belonging thereto, at least three times in each week; and no lighted **candle**, lamp or torch, shall be carried or used in the workshop of any carpenter, joiner, cabinet maker, wheel-wright, or other shop where wood shavings are produced or contained, or in any planing mill, shingle or heading manufactory, unless the same shall be safely placed in a lantern, or be otherwise securely covered and guarded against the communication of fire. Any persons offending against the provisions of this section, or either of them, shall forfeit and pay a penalty of **TWO DOLLARS** for each offence.

§ 16. No carpenter, joiner, or other person, shall throw or deposit any **shavings**, chips, or other combustible material in any street, lane or alley, or at any time permit any such combustible material to be taken to or thrown or scattered in any street or alley, under a penalty of **TWO DOLLARS** for each offence.

§ 17. No **chimney** or flue shall be burned out except between sunrise and three o'clock in the afternoon, nor at any time unless the adjoining roof or roofs shall be wet or covered with snow, under a penalty of **THREE DOLLARS**.

§ 18. No person shall make or cause to be made, or aid, countenance or assist in making or spreading a **false alarm** of fire, knowing the same to be false, under a penalty of **TWENTY-FIVE DOLLARS** for each offence.

§ 19. No person shall at any time enter any store-house, cellar, vault, or other building or place used for the storage of **petroleum**, rock or earth oil, or any of its products, with any artificial light, either candle, lamp or torch, or shall light a match, or smoke or use or have a lighted cigar or pipe in any such building or place so used for the storage of any such oil or of its products. Any person who shall offend against any of the provisions of this section shall forfeit and pay a penalty of **FIFTY DOLLARS** for each offence.

§ 20. Every execution issued upon a judgment for the violation of any of the provisions of this ordinance shall command the amount to be made of the property of the defendant, if any such can be found, and if not, then to commit the defendant to the Monroe county penitentiary for the period of **TWENTY DAYS**.

§ 21. All moneys collected under the 8th, 9th, 10th, 11th, 12th, 13th, 14th, 15th, 16th, 17th, 18th, and 19th sections of this ordinance, shall be paid by the officer collecting the same to the "treasurer of the fire department of the city of Rochester," as incorporated by an act of the legislature of the State of New York, and shall become a part of the fund of the said corporation for the aid and relief of sick, disabled or indigent firemen and their families.

§ 22. The committee on fire department may, whenever they deem it advisable, and as soon as practicable after the occurrence of any fire within the city, investigate and ascertain the cause thereof, the amount of property destroyed or injury done, and the amount of insurance thereon, by the oaths of witnesses to be summoned before the said committee and duly sworn by the chairman of said committee or by the Mayor. The deposition of said witnesses shall be reduced to writing, and shall be signed by the witnesses and attested by the persons administering such oath, and shall be preserved among the records of the city.

CHAPTER III.

HACKNEY COACHES AND CARRIAGES.

Passed June 10th, 1868.

The Common Council of City of Rochester do ordain as follows; extract—

SECTION 6. Hackney coaches, cabs, or carriages, **waiting for employment** shall at all times stand, Sundays excepted, on the south side of W. Main street from Irving place to Fitzhugh street, with the horses' heads towards the east, and on the west side of Irving place from W. Main street to the south gate of

A. R. PRITCHARD & LIKLY,

*Gloves, Canes, Etc., a Large Stock,
No. 78 STATE STREET.*

Court House lawn; and on the east side of Fitzhugh street from W. Main street to said south gate, with the horses' heads towards the north; and on Front street from Mumford street to the N. Y. Central Railroad depot, with the horses' heads towards the south; on the east side of Exchange, opposite the Genesee Valley depot; and on the south side of Main street from the west bank of the Genesee river to the east bank thereof, with the horses' heads towards the east; or at such other place or places as the Mayor, under the direction of the common council, may designate, and not elsewhere, under the penalty of FIVE DOLLARS for each offense, to be sued for and recovered from the owner or driver thereof, severally and respectively.

§ 8. The prices or rates of fare to be taken or paid to the owner or drivers of hackney coaches, cabs or carriages, shall be as follows, to wit:

1st. For conveying a passenger within the limits herein described as territory No. 1; and which is designated on the map as territory included within the red lines thereon, FIFTY CENTS.

2d. For conveying a passenger from any point within the blue lines or territory herein described as No. 2, to any point outside of the limits of territory No. 1; and within the limits herein described as territory No. 2, and which is designated on the map as territory included within the blue lines, and between the red and blue thereon, SEVENTY-FIVE CENTS.

3d. For conveying a passenger from any point within the limits of the city to any point outside the limits of territory No. 2, and within the limits herein described as territory No. 3, and which is designated on the map as territory included within the city lines, and between the blue and city lines thereon, ONE DOLLAR.

4th. For each additional passenger, TWENTY-FIVE CENTS.

5th. Half-fare shall be allowed for returning to place of starting, provided there is a detention of not longer than fifteen minutes; when over that, full fare.

6th. For conveying a pleasure party to Mt. Hope and return, THREE DOLLARS—one hour being allowed at the grounds.

7th. For the use of a hackney coach, cab or carriage by the hour, to the extent of the capacity of the vehicle, ONE DOLLAR and FIFTY CENTS, and the same proportion for fractional parts of an hour.

8th. For attending a funeral with passengers, including charges for necessary detention and returning with passengers from house, THREE DOLLARS.

9th. For children between eight and twelve years of age, half price only to be charged, and for children under eight years of age, no charge is to be made.

10th. A sum exceeding ten dollars shall not be demanded for the use of any hackney coach, cab or carriage in carrying persons to and from the polls on election day.

11th. In case of a dispute or disagreement between the driver of any hackney coach, cab or carriage, and the hirer or occupant thereof, when demanded, said driver shall drive to the nearest policeman, who shall decide the matter, and no charge shall be made for the extra drive or ride.

Territory No. 1, for which fifty cents is to be charged: extends on N. St. Paul street to Gorham; on N. Clinton st. to Ward; on North st. to Hudson; on Scio to Tappan; on E. Main st. to University av.; on East av. to Union; on Monroe av. to Union; on Broadway to Alexander; on South av. to Alexander; on Mt. Hope av. to Alexander; on Exchange st. to Glasgow; on Plymouth av. to Glasgow; on Caledonia av. to Glasgow; on Reynolds st. to Hunter; on West av. to Reynolds; on Brown st. to Maple; on Magne st. to Grape; and on State st. to Lyell.

Territory No. 2, for which seventy-five cents is to be charged, lies outside of Territory No. 1, and extends on N. St. Paul st. to Lowell; on Clinton st. to Lowell; on North st. to Woodbury; on Scio st. to Lewis; on E. Main st. to Prince; on University av. to Prince; on East av. to Meigs; on Monroe av. to Meigs; on Broadway to Meigs; on South av. to Gregory; on Mt. Hope av. to Clarissa; on Exchange to Clarissa; on Plymouth av. to Bartlett; on Frances st. to Bartlett; on Genesee st. to Champlain; on West av. to Brown; on Brown st. to West av.; on Orange st. to Orchard; on Lyell st. to Orchard; and on Lake av. to Jones av.

Territory No. 3 embraces all of the city outside of territory No. 2.

§ 9. No owner or driver of any hackney coach, cab or carriage, in the city of Rochester, shall ask, demand, or receive any larger sum than he or they may be entitled to receive as aforesaid, under the penalty of TEN DOLLARS for every such offense, to be sued for and recovered from the owner or owners, or the driver of any such coaches, cabs or carriages, severally and respectively; and no such owner or driver shall demand, or receive from any such person or passenger, any extra compensation, or any sum whatever, for carrying and

transporting with such person or passenger, in or upon such hackney coach, cab or carriage, any ordinary luggage belonging to any such person or passenger, to or from any of the points, or distances above mentioned.

§ 10. The **number** of the license of every hackney coach, cab or carriage shall be painted in legible characters on the outside thereof, or on the lamps, and a printed copy of the map describing the territory, and of the different rates of fare to be charged, together with section eight, of this ordinance, shall be framed and hung up in some conspicuous place in the inside of such coach, cab or carriage, under a penalty of **TEN DOLLARS** for each offense, to be sued for and recovered from the owner or driver of such hackney coach, cab or carriage, severally and respectively.

Every driver of a hackney coach, cab or carriage, licensed as hereinbefore provided, shall, on each and every occasion, when his carriage shall be hired, deliver to the hirer thereof a **card**, with the name of the owner, the driver, and the number of the hack thereon, under a penalty of **FIVE DOLLARS** for each offense, to be sued for and recovered, in the manner herein provided.

§ 12. No owner or driver of any hackney coach, cab or carriage, while on the stand heretofore designated, or whilst waiting for employment at any place other than the house or stable of the owner thereof, between the hours of sunrise and ten o'clock in the evening, shall **refuse and neglect to convey any person** or persons to any place or places within the limits of the city, upon being applied to for that purpose, and upon being tendered the fare for the same, under a penalty of **FIVE DOLLARS** for every such refusal or neglect, to be sued for and recovered of the owner or driver of any such hackney coach, cab or carriage, severally and respectively.

CHAPTER XXXIV.

PROTECTION OF THE FIRE ALARM TELEGRAPH.

Passed February 3d, 1869.

The Common Council of the City of Rochester do ordain as follows :

SECTION 1. Any person who shall make or cause to be made or have in his possession any **key**, impression or duplicate of any signal box of the fire alarm telegraph in said city, without the express permission or authority of the committee on fire department of said city, shall forfeit and pay a penalty of **TEN DOLLARS** for each offense.

§ 2. No person shall give or cause to be given a **false alarm** with intent to deceive, or to pull the slide of any station or signal box, except in case of fire in said city, or to tamper, meddle or in any way interfere with said signal boxes or any part thereof, or to cut, break, injure, deface or remove any of said boxes, or any part or portion thereof, or any wires or supports thereof, connected with any part of said fire alarm telegraph, or to make any connection or communication therewith, so as to interrupt or interfere with the proper working of the same, or with intent to injure, break or destroy any machinery or fixtures connected therewith, except the owner, agent or occupant of any house or building, or other private property, on which such telegraph or any part thereof may be suspended or otherwise; provided such owner, agent or occupant give notice of the same to the fire department committee of the common council. Any person violating any of the provisions of this section shall forfeit and pay a penalty of **ONE HUNDRED AND FIFTY DOLLARS**.

§ 3. Every execution issued upon a judgment recovered for a **violation** of any of the provisions of section 1 of this ordinance shall command the amount to be made of the property of the defendant, if any such can be found, and if not then to commit the defendant to the Monroe county penitentiary for a period of **TEN DAYS**; and for a violation of any of the provisions of section 2 of said ordinance shall command the amount to be made of the property of the defendant, if any such can be found, and if not, then to commit the defendant to the Monroe county penitentiary for a period not exceeding **NINETY DAYS**.

CHAPTER XXXV.

FIRES AND THE FIRE DEPARTMENT.

Passed March 8d, 1869.

The Common Council of the City of Rochester do ordain as follows :

SECTION 1. The Fire Marshal and Chief Engineer of the city of Rochester, under the direction of the fire department committee of the common council,

A. R. PRITCHARD & LIKLY, TRAVELERS' GOODS, ALL KINDS
No. 78 STATE STREET.

shall furnish to the Mayor, each member of the common council, press reporters and insurance agents of the said city, a suitable **badge** by which they may be designated.

§ 2. Every person acting as a member of the fire department, while on duty attending fires, shall wear such **badge** on some conspicuous place on his person, so that he may be known and distinguished as such.

§ 3. No person shall wear a **badge** corresponding to those worn by the members of the fire department of said city, at any fire therein, except the Mayor, members of the common council, press reporters and insurance agents.

§ 4. No person shall enter any dwelling, store or building that may be on fire or adjacent thereto, during the continuance thereof; nor remove, assist, or attempt to remove any personal property therein, without the permission of the Fire Marshal or Chief Engineer of the fire department of said city, **without** having on a **badge** recognized by the Fire Marshal, except owners of property therein or their agents, the police commissioners, police officers, the Mayor, members of the common council, press reporters and insurance agents. Nor shall any person, during the continuance of any fire in said city, in any manner **hinder, delay** or obstruct the members of the fire department, police officers, or other officers of said city in suppressing such fire or the removal of property liable to be consumed thereby.

§ 5. A **receipt** shall be given for each badge delivered by the Fire Marshal, and all persons holding such badges are prohibited from selling, lending or giving them away; and said badges are to be returned to the Fire Marshal when demanded by him, or when they cease to be entitled to them, by expiration of their term of office or otherwise.

§ 6. Every person offending against any of the provisions of sections 2, 3, 4 and 5 of this ordinance, shall, upon conviction thereof, forfeit and pay a penalty of **TWENTY-FIVE DOLLARS** for each offense. Every execution issued upon a judgment for the violation of any of the provisions of this ordinance shall command the amount to be made of the property of the defendant, if any can be found, and if not, then it shall be lawful to commit the defendant to the Monroe county penitentiary for the period of **TEN DAYS**.

DIRECTORIES FOR SALE.

New York State Directory, - - - -	\$6.00
New England Directory, - - - -	6.00
Ohio State Directory, - - - -	6.00
Pennsylvania State Directory, - - - -	5.00
Illinois State Directory, - - - -	5.00
Canada Directory, - - - -	10.00
Havana and Island of Cuba Directory, - -	5.00

And all other State and City Directories for sale at publishers' prices. Directories loaned at reasonable rates.

DREW, ALLIS & CO.,

114 Powers' Buildings.

HENRY C. WISNER, THE CELEBRATED (Sole Agency) "MONELLE WARE"--No. 33 STATE STREET.

STATISTICS OF CITIES.

Arranged in order of Population, U. S. Census of 1870.

CITIES.	TOTAL POPULATION.	BORN IN							
		UNITED STATES	FOR-IGN BORN.	BRIT-ISH AM.	ENG-LAND.	IRE-LAND.	FRANCE	GER-MANY.	SWIT-ZER-LAND.
1. New York.....	942,292	523,198	419,094	4,419	24,442	201,999	8,265	151,216	2,178
2. Philadelphia.....	674,022	490,398	183,624	1,488	22,034	96,698	2,479	50,746	1,791
3. Brooklyn.....	396,099	251,381	144,718	2,506	18,843	73,985	1,894	36,771	667
4. St. Louis.....	310,864	198,615	112,249	2,008	5,367	32,239	2,788	59,040	2,902
5. Chicago.....	298,977	154,420	144,557	9,648	10,027	39,998	1,418	52,318	1,226
6. Baltimore.....	287,354	210,870	56,484	301	2,142	15,223	437	35,276	169
7. Boston.....	250,526	162,540	87,986	13,818	5,977	56,900	615	5,606	201
8. Cincinnati.....	216,239	136,627	79,612	1,193	3,526	18,624	2,093	49,448	995
9. New Orleans.....	191,418	142,943	48,475	399	2,920	14,693	8,845	15,239	668
10. San Francisco.....	149,473	75,754	73,719	2,363	5,172	25,864	3,547	13,602	775
11. Buffalo.....	117,714	71,477	46,237	4,174	3,563	11,264	2,232	22,249	612
12. Washington.....	109,199	95,442	13,757	239	1,235	6,948	193	4,133	146
13. Newark.....	105,050	69,175	35,884	303	4,041	12,481	710	15,873	613
14. Louisville.....	100,753	75,085	25,668	321	932	7,626	866	14,380	560
15. Cleveland.....	92,829	54,014	38,815	2,634	4,533	9,964	339	15,856	704
16. Pittsburgh.....	80,078	58,254	27,822	291	2,838	13,119	348	8,708	332
17. Jersey City.....	82,546	50,711	31,835	557	4,008	17,665	276	7,151	303
18. Detroit.....	79,577	44,196	35,381	7,724	3,284	6,970	760	12,647	462
19. Milwaukee.....	71,440	37,667	33,773	799	1,395	3,784	189	22,599	346
20. Albany.....	69,422	47,215	22,207	849	1,572	13,276	150	5,168	86
21. Providence.....	63,904	51,727	17,177	1,050	2,427	12,085	72	592	34
22. Rochester.....	62,586	41,202	21,164	2,658	2,530	6,073	475	7,730	440
23. Allegheny.....	53,180	37,972	15,308	106	1,112	4,034	619	7,665	547
24. Richmond.....	51,038	47,260	3,778	42	289	1,239	144	1,621	19
25. New Haven.....	50,840	36,432	14,358	344	1,089	9,901	133	2,423	48
26. Charleston.....	48,956	44,064	4,892	33	238	2,180	97	1,836	24
27. Indianapolis.....	48,244	37,587	10,657	305	698	3,321	227	5,286	210
28. Troy.....	46,465	30,246	16,219	1,699	1,576	10,877	88	1,174	34
29. Syracuse.....	43,051	29,061	13,990	1,181	1,345	5,172	276	5,062	175
30. Worcester.....	41,105	29,159	11,946	1,963	895	8,889	29	325	6
31. Lowell.....	40,928	26,493	14,435	3,039	1,697	9,103	38	34	2
32. Memphis.....	40,226	33,446	6,780	232	522	2,987	207	1,773	162
33. Cambridge.....	39,634	27,579	12,055	2,587	1,044	7,180	100	482	25
34. Hartford.....	37,180	26,363	10,817	396	789	7,438	92	1,458	27
35. Scranton.....	35,092	19,205	15,887	125	1,445	6,491	64	3,056	97
36. Reading.....	33,930	30,059	3,871	32	305	547	77	2,648	72
37. Patterson.....	33,579	20,711	12,868	128	3,347	5,124	237	1,429	170
38. Kansas City.....	32,260	24,581	7,679	824	709	2,869	111	1,884	160
39. Mobile.....	32,034	27,795	4,239	55	388	2,000	312	843	82
40. Toledo.....	31,584	20,485	11,099	1,019	694	3,032	206	5,341	375
41. Portland.....	31,413	24,401	7,012	2,051	558	3,900	23	82	2
42. Columbus.....	31,274	23,663	7,611	194	505	1,845	238	3,982	194
43. Wilmington.....	30,841	25,689	5,152	49	615	8,508	64	695	31
44. Dayton.....	30,473	23,050	7,423	133	394	1,328	242	4,992	116
45. Lawrence.....	28,921	16,204	12,717	1,564	2,456	7,457	4	467	4
46. Utica.....	28,804	18,955	9,849	263	1,352	3,496	287	2,822	174
47. Charlestown.....	28,323	21,399	6,924	1,129	488	4,903	29	216	8
48. Savannah.....	28,235	24,564	3,671	63	252	2,197	101	800	22
49. Lynn.....	28,233	23,298	4,935	1,229	330	3,232	5	17	1
50. Fall River.....	26,766	15,288	11,478	1,326	4,043	5,572	3	37	2

STREET NUMBERS

FOR SALE AT

DIRECTORY OFFICE, - 114 Powers' Buildings.

White Metal Figures, Height, 1½ inches. Silver Close Plated Figures, Height, 2 inches.
 Nickel Plated " " 2 " Enamelled Tin, Gold " " 2 "
 Electro-Silver Plated Figures, " " " *Prices, 10c. to 50c. per Figure.*

—ALSO,—

Engraved Silver Door Plates and Numbers.

OF SUPERIOR QUALITY AND WORKMANSHIP.

DREW, ALLIS & CO.

A. R. PRITCHARD & LIKLY, SOLID RED CEDAR TRUNKS, No. 78 STATE STREET.

MONROE COUNTY.

Incorporated 1821.

BOARD OF SUPERVISORS. (*Elected Annually.*)

ROCHESTER.

- | | |
|----------------------------|------------------------------|
| WARD 1.—Luther A. Pratt. | WARD 9.—George W. Jacobs. |
| WARD 2.—James Day. | WARD 10.—Daniel Lowery. |
| WARD 3.—Charles F. Pond. | WARD 11.—John Greenwood. |
| WARD 4.—James E. Hayden. | WARD 12.—George D. Shaffer. |
| WARD 5.—Charles Englert. | WARD 13.—Oluf Oswald. |
| WARD 6.—Samuel Rosenblatt. | WARD 14.—William H. Dake. |
| WARD 7.—Charles H. Webb. | WARD 15.—Henry Klinkhammer. |
| WARD 8.—William Wright. | WARD 16.—Henry B. McGonegal. |

TOWNS.

- | | |
|-----------------------------------|--------------------------------|
| BRIGHTON.—Ira Todd. | PARMA.—Rodney P. Odell. |
| CHILI.—Frederick Fellows. | PENFIELD.—Alanson Higbie. |
| CLARKSON.—Washington L. Rockwell. | PERINTON.—George L. G. Seeley. |
| GATES.—Reuben L. Field. | PITTSFORD.—George A. Goss. |
| CREECE.—Peter Larkin. | RIGA.—Henry W. Davis. |
| HAMLIN.—Walter A. Ferris. | RUSH.—George H. Houck. |
| HENRIETTA.—Samuel Beckwith. | SWEDEN.—L. T. Underhill. |
| IRONDEQUOIT.—Henry Walzer. | WEBSTER.—John H. Whitbeck. |
| MENDON.—Homer C. Ely. | WHEATLAND.—Philip Garbut. |
| OGDEN.—William B. Arnold. | |

County Clerk.—John H. Wilson; salary, fees; term, three years; term expires December 31, 1876.

Deputy Clerk.—Jeremiah Cutler. Appointed by the County Clerk.

Assistant Deputy Clerk.—J. Horace McGuire. Appointed by the County Clerk.

Special Deputy Clerks.—Henry D. McNaughton, Benjamin F. Freeman, Peter Burns. Appointed by the County Clerk.

County Treasurer.—Charles P. Achilles; salary, \$4,000; term, three years; term expires October 4, 1876.

District Attorney.—George Raines; salary, \$3,000, fixed by Supervisors. Elected by the people every three years; term expires Dec. 31, 1877.

Assistant District Attorney.—Angus McDonald; appointed by District Attorney. Salary \$800.

Clerk Board Supervisors.—George Breck; salary, \$1,100. Appointed annually by the Supervisors.

Loan Commissioners.—Willard Hodges, Brighton; George Truesdale, Rochester. Appointed by the Governor.

County Sealer of Weights and Measures.—Frederick Buchhecker.

Librarian Law Library.—C. M. Crittenden; salary, \$400, additional from the State \$600. Appointed annually by the Supervisors.

Messenger and Assistant Law Librarian.—David Niven; salary, \$3 per diem during session of board. Appointed annually by the Supervisors.

Janitor Court House.—David Niven; salary \$800.

Watchman Court House.—Patrick McFarland. Salary, \$50 per month.

SHERIFF AND DEPUTIES.

Office at Court House.

Sheriff.—Henry E. Richmond; term, three years; term expires Dec. 31, 1878.

Under Sheriff.—James E. Thompson.

Deputy Sheriff and Jailor.—James K. Burlingame.

City Deputies.—Lewis Miles, Franklin Ritter, Lyman M. Newton, Emory Dake. At Court, Benjamin F. Freeman, Peter Burns.

Deputy Sheriffs.—Pittsford, John H. Osgoodby; Penfield, Nathan S. Perkins, Josiah G. Fish; Rush, Jacob Albertson; Spencerport, Charles A. Webster; Churchville, Wilson Sprague; Brockport, Henry Chappell; Riga, H. Addison Richmond; Gates, Carlisle Barsdale.

CORONERS.

Elected for a term of three years.

Thomas W. Morrison, Rochester, term expires Dec. 31, 1877; John N. Harder, Rochester, term expires Dec. 31, 1876; J. Addison Burrows, Penfield, term expires Dec. 31, 1876; Wm. S. Milliner, Spencerport, term expires Dec. 31, 1877; H. Auchampaugh, Penfield, term expires Dec. 31, 1877.

HENRY C. WISNER, SUPERIOR ENGLISH CARVERS and BEEF SLICERS--No. 33 STATE STREET.

MONROE COUNTY PENITENTIARY.

Inspectors of the Penitentiary.—Patrick Barry, Rochester; Russell C. Bates, Parma; Patrick Malone, Pittsford; Homer C. Ely, Mendon Centre; \$3 per diem for each day.

Superintendent.—Alexander McWhorter; appointed by the Supervisors; salary, \$1,700.

Chaplain.—John E. Baker, salary, \$225. Fixed by the Inspectors.

MONROE COUNTY POOR HOUSE.

Superintendent.—George E. McGonegal, salary, \$2,000; fixed by Supervisors; elected every three years; term expires December 31, 1876.

Warden.—Eugene H. Howard, salary, \$700; fixed by Superintendent. Appointed by the Superintendent.

Physician.—Azal Backus, salary, \$900; Resident physician, John R. Mullen.

Chaplain.—Geo. F. Lindfield, salary, \$200.

County Relief Store.—at City Buildings; Front street, clerk John A. Harold, salary \$400. Fixed by the Superintendent.

INSANE ASYLUM.

Warden.—M. L. Lord, salary, \$1,200. Appointed by the Supervisors.

Physician.—M. L. Lord, salary, \$200.

Chaplain.—Geo. F. Lindfield, salary, \$150.

Trustees.—Henry Churchill, Rochester; J. W. Craig, Churchville; Chas. Wright, Webster; \$3 per diem for each day of service.

JAIL.

Jailor.—James K. Burlingame. Appointed by the Sheriff.

Physician.—T. A. Daly, salary, \$125.

Chaplain.—T. H. Coddling, salary, \$100.

COURTS.

Court House at Rochester.

SUPREME COURT

FOURTH JUDICIAL DEPARTMENT. (General Term).

Includes the Fifth, Seventh and Eighth Judicial Districts.

Presiding Justice.—Joseph Mullin, Watertown.

Associate Justices.—E. Darwin Smith, Rochester; John L. Talcott, Buffalo.

TERMS.

1st Tuesday of January, at Syracuse; 1st Tuesdays of April and October, at Rochester; 2d Tuesday of June, at Buffalo.

SEVENTH JUDICIAL DISTRICT OF NEW YORK.

Includes the Counties of Livingston, Wayne, Seneca, Yates, Ontario, Steuben, Monroe, Cayuga.

JUSTICES.—Terms of office 14 years.

E. Darwin Smith, Rochester; salary, \$6,000; term expires Dec. 1876.

James C. Smith, Canandaigua; salary, \$6,000; term expires Dec. 1887.

Charles C. Dwight, Auburn; salary, \$6,000; term expires Dec. 1877.

David Rumsey, Bath; salary, \$7,200; term expires Dec. 1880.

CIRCUIT COURTS AND COURTS OF OYER AND TERMINER FOR 1876 and 1877.

MONROE COUNTY.—First Monday of January, Smith; first Monday of March, Dwight; second Monday of June, Rumsey; first Monday of October, Smith.

STEBEN COUNTY.—First Monday of January (Bath), Rumsey; second Monday of April (Corning), Smith; second Monday of September (Bath), Rumsey; second Monday of November (Corning), Dwight.

CAYUGA COUNTY.—First Monday of January, Dwight; first Monday of May, Smith; first Monday of October, Rumsey.

ONTARIO COUNTY.—Second Monday of February, Smith; second Monday of May, Dwight; second Monday of December, Rumsey.

WAYNE COUNTY.—Fourth Monday of January, Dwight; fourth Monday of May, Rumsey; fourth Monday of December, Smith.

LIVINGSTON COUNTY.—Third Monday of February, Dwight; first Monday of May, Rumsey; second Monday of November, Smith.

**A. R. PRITCHARD & LIKLY, TRAVELERS' GOODS, All Kinds,
No. 78 STATE STREET.**

YATES COUNTY.—First Monday of June, Dwight; fourth Monday of November, Rumsey.

SENECA COUNTY.—First Monday of March (Waterloo), Smith; fourth Monday of September (Ovid), Dwight.

SPECIAL TERMS FOR TRIAL OF EQUITY CASES FOR 1876 AND 1877.

MONROE COUNTY.—Second Monday of February, Rumsey; second Monday of December, Dwight.

STREUBEN COUNTY.—Third Monday of March (1876, Bath, 1877, Corning), Rumsey.

CAYUGA COUNTY.—Fourth Monday of March, Dwight.

ONTARIO COUNTY.—Third Monday of March, Smith.

WAYNE COUNTY.—Fourth Monday of June, Smith.

LIVINGSTON COUNTY.—Third Monday of June, Smith.

YATES COUNTY.—Fourth Monday of January, Rumsey.

SENECA COUNTY.—First Monday of April (1876, Waterloo, 1877, Ovid), Dwight.

SPECIAL TERMS FOR MOTIONS, TO BE HELD AT ROCHESTER ON THE LAST MONDAY OF EACH MONTH.

January, Smith; February, Rumsey; March, Dwight; April, Smith; May, Dwight; June, Rumsey; July, Smith; August, Dwight; September, Rumsey; October, Smith; November, Dwight; December, Rumsey.

In the Seventh District, contested motions in actions triable in any county may be noticed for the Equity Terms in such county, but such motions will not be heard at any Special Term held at the same time and place with a Circuit, except in actions upon the Calendar for trial at such Circuit, and in which the hearing of the motions is necessary to the disposal of the cause.

COURT OF APPEALS.

Term of office fourteen years. Salary \$7,000.

Chief Judge.—Sanford E. Church, Albion; salary \$500 additional; term expires Dec. 31, 1884.

Associate Judges.—Wm. F. Allen, Albany; term expires Dec. 31, 1878. Chas. A. Rapallo, New York; Charles Andrews, Syracuse; Charles J. Folger, Geneva; terms expire Dec. 31, 1884. Theodore Miller, Hudson; term expires Dec. 31, 1886. Robert Earl, Herkimer; term expires Dec. 31, 1876.

Clerk.—Edwin O. Perrin, Jamaica.

Deputy Clerk.—E. Stanton Perrin.

COUNTY COURT AND COURT OF SESSIONS.

County Judge.—Jerome Fuller, of Brockport; salary, \$4,000, fixed by statute; term six years; term expires Dec. 31, 1877.

Special County Judge.—Pierson B. Hulett; salary, \$1,000, fixed by the Supervisors; term three years; term expires Dec. 31, 1876.

JUSTICES OF SESSIONS.

John Borst, Ogden; Napoleon B. Jones, Wheatland.

TERMS OF COURT.

Fourth Monday of January, with a Petit Jury, Fourth Monday of March, with a Petit Jury; First Monday of May, with a Petit Jury; First Monday of June, without a Jury; Second Monday of September, with a Petit Jury; Second Monday of November, with a Petit Jury.

SURROGATE'S COURT.

Surrogate.—Wm. D. Shuart, salary, \$4,000, fixed by statute; term six years; term expires Dec. 31, 1876.

Sessions Daily. Hours 10 A. M. to 12½ P. M.; 2 to 5 P. M.

HENRY C. WISNER,

*MAJOLICA, KIYOTA AND JAPANESE
CHINA, No. 33 STATE STREET.*

UNITED STATES COURTS.

NORTHERN DISTRICT OF NEW YORK.

CIRCUIT COURT.

Associate Justice S. C. U. S.—Ward Hunt, of Utica, N. Y.
Circuit Judge.—Alex. S. Johnson, of Utica, N. Y.
District Attorney.—Richard Crowley, of Lockport.
Clerk.—Charles Mason, of Utica. *Deputy Clerk.*—William L. Bonney.
U. S. Marshal.—Isaac F. Quinby, office 27 State street.
Deputy Marshal.—Ambrose N. Lane, office 27 State Street.
U. S. Commissioners.—William W. Gilbert, 27 State street; Joseph D. Husbands, 143 Powers' Buildings.

TERMS OF CIRCUIT COURT.

3d Tuesday in June, at Canandaigua; 2d Tuesday in October, at Albany. Adjourned Circuits for civil business only to use District Jury; 3d Tuesday in January, at Albany; 3d Tuesday in March, at Utica.

DISTRICT COURT.

District Judge.—William J. Wallace, of Syracuse.
Clerk.—Winfield Robbins, of Buffalo.
Deputy Clerk.—Joseph L. Herschbeck, Buffalo.
Register in Bankruptcy.—Joseph D. Husbands, Rochester; office, 143 Powers' Buildings.

TERMS OF DISTRICT COURT

District Court.—3d Tuesday in January, at Albany; 3d Tuesday in March, at Utica; 2d Tuesday in May, at Rochester; 3d Tuesday in August, at Buffalo; 3d Tuesday in November, at Auburn.

Bankruptcy Sessions.—Tuesdays and Fridays, at Syracuse.

Admiralty Sessions.—At Syracuse, every Tuesday.

UNITED STATES GOVERNMENT.

1876.

THE EXECUTIVE.

President.—ULYSSES S. GRANT, of Illinois; salary \$50,000; term expires March 4, 1877.

Vice-President.—THOMAS W. FERRY, of Michigan, *ex-officio* as President *pro tempore* of Senate; salary \$10,000; term expires March 4, 1877.

THE CABINET.

Salary, \$10,000.

Secretary of State.—Hamilton Fish, of New York.

Secretary of the Treasury.—Benjamin Helms Bristow, of Kentucky.

Secretary of War.—J. Donald Cameron, of Pennsylvania.

Secretary of the Navy.—George M. Robeson, of New Jersey.

Secretary of the Interior.—Zachariah Chandler, of Michigan.

Postmaster-General.—Marshall Jewell, of Connecticut.

Attorney-General.—Alphonso Taft, of Ohio.

LEGISLATIVE.

Forty-Fourth Congress; commencing March 4, 1875; ending March 4, 1877.

President of the Senate.—Thomas W. Ferry, of Michigan, *pro tempore*.

Senators from New York.—Roscoe Conklin, term expires, 1879; Francis Kernan, term expires, 1881.

Speaker of the House of Representatives.—Michael C. Kerr, of Indiana.

A. R. PRITCHARD & LIKLY,

SOLID RED CEDAR TRUNKS,
No. 78 STATE STREET.

Representatives from New York—numbers refer to Congressional Districts :—

1 Henry B. Metcalfe	12 N. Holmes Odell	23 Scott Lord
2 John G. Schumaker	13 John O. Whitehouse	24 Wm. H. Baker
3 Simeon B. Crittenden	14 Geo. M. Beebe	25 Elias W. Leavenworth
4 Archibald M. Bliss	15 John M. Bagley jr.	26 Clinton D. McDougall
5 Edwin R. Meade	16 Chas. H. Adams	27 Elbridge G. Lapham
6 Samuel S. Cox	17 Martin I. Townsend	28 Thomas C. Platt
7 Smith Ely jr.	18 Andrew Williams	29 Chas. C. B. Walker
8 Elijah Ward	19 Wm. A. Wheeler	*30 John M. Davy
9 Fernando Wood	20 Henry H. Hathorn	31 George G. Hoskins
10 Abram S. Hewitt	21 Samuel F. Miller	32 Lyman K. Bass
11 Benjamin A. Willis	22 Geo. A. Bagley.	33 Nelson I. Norton

*Thirtieth Congressional District comprises the Counties of Monroe and Orleans.

U. S. INTERNAL REVENUE.

TWENTY-EIGHTH COLLECTION DISTRICT OF NEW YORK.

(Includes the Counties of Monroe, Orleans, Livingston, Ontario and Yates.)

Collector.—Francis S. Rew. Office, 7 Powers' Buildings.

Deputy Collectors.—Charles R. Davis and Lewis C. Leist, Rochester; V. V. Bullock, Albion; Geo. A. Newell, Medina; Robert N. McFarren, Penn Yan.

Clerk.—John A. Davis, office hours from 9 A. M., to 3 P. M.

CUSTOM HOUSE.

DISTRICT OF THE GENESEE EXTENDS FROM PULTNEYVILLE TO OAK ORCHARD.

Office 31 *State Street.*

By regulation of the Treasury Department, the Custom House opens at 9 A. M. and closes at 4 P. M., for the transaction of business through the year.

Collector.—David K. Cartter.

Special Deputy.—Chas. W. Wall.

Deputy Collectors.—Jas. Hutchison, Henry B. Wilcox, Chas. A. Clark, at Rochester; Benjamin W. Wilber, at Charlotte.

Inspectors.—J. L. Luckey, Wm. H. Crittenden, at Rochester.

NEW YORK STATE GOVERNMENT.

1876.

EXECUTIVE DEPARTMENT.

Governor.—SAMUEL J. TILDEN.

Lieutenant-Governor.—William Dorsheimer.

Secretary of State.—John Bigelow.

Comptroller.—Lucius Robinson.

Treasurer.—Charles N. Ross.

Attorney-General.—Charles S. Fairchild.

State Engineer.—John D. Van Buren, Jr.

Superintendent Public Instruction.—Neil Gilmour.

Superintendent Bank Department.—DeWitt C. Ellis; term 3 years.

Superintendent Insurance Department.—William Smith; term 3 years.

State Assessors.—John S. Fowler, Auburn; James A. Briggs, Brooklyn; Sterling G. Hadley, Waterloo; term of office 3 years.

Commissioners of Fisheries.—Horatio Seymour, Utica; Robert B. Roosevelt, New York; Edward M. Smith, Rochester. Superintendent, Seth Green, Rochester.

Superintendent Weights and Measures.—John Patterson, Albany.

LEGISLATIVE DEPARTMENT.

Senators—numbers refer to Senatorial Districts :—

1 L. Bradford Prince	8 Francis M. Bixby	15 Webster Wagner
2 John R. Kennaday	9 Wm. H. Robertson	16 Franklin W. Tobey
3 John C. Jacobs	10 Daniel B. St. John	17 Darius A. Moore
4 John Morrissey	11 B. Platt Carpenter	18 James F. Starbuck
5 James W. Booth	12 Thomas Coleman	19 Theodore S. Sayre
6 Caspar A. Baaden	13 Hamilton Harris	20 David P. Loomis
7 James W. Gerard	14 A. Schoonmaker jr.	21 Benjamin Doolittle

HENRY C. WISNER,

CLOCKS--AGENCY FOR ANSONIA CLOCK CO., No. 33 STATE STREET.

22 Dennis McCarthy	26 Stephen H. Hammond	30 Abijah J. Wellman
23 William C. Lamont	27 Geo. B. Bradley	31 Sherman S. Rogers
24 John H. Selkreg	*28 William N. Emerson	32 Commodore P. Vedder
25 Wm. B. Woodin	29 Dan H. Cole	

*Twenty-eighth Senatorial District comprises the County of Monroe.

Assemblymen.—Dist. 1, Willard Hodges; Dist. 2, James S. Graham; Dist. 3, Heman Glass.

Assembly Districts.—Monroe County is divided into three Assembly Districts; Dist. 1.—Brighton, Henrietta, Irondequoit, Mendon, Penfield, Perinton, Pittsford, Rush, Webster, Ward 16 of Rochester.

Dist. 2.—Wards 1, 2, 3, 4, 5, 6, 7, 8, 9, 10, 11, 12, 13, 14 of Rochester.

Dist. 3.—Chili, Clarkson, Gates, Greece, Ogden, Parma, Riga, Sweden, Hamlin, Wheatland, Ward 15 of Rochester.

CANALS.

COMMISSIONERS.

Elected for a term of three years. Salary \$2,000.

Eastern Division.—Adin Thayer, of Hoosic Falls; term expires January 1, 1878.

Middle Division.—Christopher A. Walrath, of Oneida; term expires January 1, 1879.

Western Division.—James Jackson, jr., of Lockport; term expires January 1, 1877.

Canal Auditor.—Geo. W. Schuyler; term expires 1879.

Canal Appraisers.—Vivus W. Smith, Syracuse; term expires 1876. Chas. G. Myers, Ogdensburgh; term expires Jan. 1876.

OFFICERS OF THE WESTERN DIVISION.

Appointed by the Canal Board.

CANAL OFFICE AT WEIGH LOCK, SOUTH ST. PAUL STREET.

Superintendent Section 10 Erie Canal.—Wm. H. Bunn.

Collector.—Henry E. Rochester.

Clerks.—W. W. Cady, H. P. Merrill,

Weighmaster.—Jacob Gerling.

Assistant Weighmasters.—Thomas H. Christy, Frank Leidecker.

Inspector.—Michael Heavey.

Division Engineer.—Wm. H. Searles. Office 153 Powers' Buildings.

Resident Engineer.—Byron M. Hanks. Office 153 Powers' Buildings.

Assistant Engineers.—John Bisgood, W. N. Radenhurst.

Superintendent Genesee Valley Canal.—Wm. A. Kirkpatrick of Cuba.

Amount receipts Erie Canal at Rochester in 1866, \$66,898.06; in 1867, \$59,421.51; in 1868, \$49,553.37; in 1869, \$59,032.29; in 1870, \$33,018.37; in 1871, \$20,463.90; in 1872, \$16,418.12; in 1873, \$19,309.70; in 1874, \$15,307.78; in 1875, \$6,240.92.

NOTARIES PUBLIC.

Appointed by the Governor to protest notes. They have power also to take acknowledgement of any legal instrument to be recorded in Monroe County.

ROCHESTER.

Abeles David
Achilles Chas P.
Adams Edward N.
Adams Jas.
Agne John F.
Allis Hubbard S.
Allyn Lewis
Amsden C. H.
Angevine O. L.
Arnoldt George

Ashley William J.
Babbitt Charles R.
Babcock Henry H.
Baker Chas. S.
Baker Wm. H.
Bancker Jno.
Bardwell John M.
Barton Alvin L.
Bentley Sardinus D.
Blyth Edward E.
Bottum Frank M.

Braman A. S.
Breck George
Brewster Henry C.
Brewster Henry P.
Briggs Marcenus H.
Bush D. W.
Caulkins Wm. R.
Cheney Jas. E. jr.
Clackner A. S.
Clark John jr.
Clarke F. D. W.

Clarke L. Ward
 Cole Otis
 Colvin Wm. M.
 Cooke M. W.
 Corning Wm. jr.
 Crandall P. M.
 Crittenden DeL.
 Crowley W. G.
 Davis Z. L.
 Drake John N.
 Edmonds Wm. E.
 Ellery Frank M.
 Elwood Geo. M.
 Enos B. F.
 Evans J. J.
 Fairchild H. S.
 Fenner E. B.
 Finding F. T.
 Gillette Loren H.
 Graebe Wm.
 Graham James J.
 Green M. H.
 Griffen E. H. C.
 Halsey Abram
 Harder John N.
 Harris Edward
 Hawks Haywood
 Hirshfield Marcus
 Holmes John F.
 Hovey Bleeker L.
 Hoyt Hiram
 Hubbard W. A. jr.
 Humphrey Geo. H.
 Huntington C. W.
 Huntington H. F.
 Husbands J. D.
 Hutchinson F. B.
 Jeffes J. H.
 Jordan Jas. A.
 Kelly Lorenzo
 Keyes Jerome
 Leiter Henry
 Luckey J. L.
 Mabbett A. L.
 Mandeville A.
 Maurer George C.
 McGlachlin H. Frank
 McGorray J. A.
 McGuire J. Horace
 McNaughton Henry D.
 McPherson W. J.
 Mitchell W. G.
 Morgan John S.
 Mosely D. E.
 Mudge W. R.
 Nash Chauncey
 O'Brien John C.
 O'Kelly Thos. P.
 Oliver W. S.
 O'Regan John C.
 Paine Theodore S.
 Parker Wm. J.
 Pond Nathan P.
 Pool Chas. A.
 Raines Eugene
 Rau Joseph
 Redfield Henry S.

Reibling A. J.
 Ritter Franklin
 Roberts G. H.
 Robinson Arthur
 Rochester G. H.
 Ross Lewin Geo. N.
 Sargent H.
 Satterlee E. H.
 Seward W. R.
 Shaffer Wm. H.
 Shepard Wm. H.
 Shepardson E. A.
 Shepherd Jesse
 Sherman W. S.
 Sill Geo. W.
 Smith A. B.
 Smith J. Moreau
 Smith Vincent M.
 Spahn Jacob
 Stern Simon
 Sweet George M.
 Thompson James E.
 Tone B. W.
 Tone T. W.
 Tracy Clark D.
 Truesdale George
 VanIngen Bernard S.
 VanVoorhis Menzo
 Vay Rudolph
 Viele P. B.
 Virgo Sidney D.
 Vredenburgh E. H.
 Ward L. F.
 Waters Wm. A.
 Webb William W.
 Wentworth Delos
 White Richard E.
 Whittlesey Fred. A.
 Wilcox Seymour G.
 Wile Isaac A.
 Wile S.
 Williams Byron C.
 Williams Chas. M.
 Williams G. D.
 Wilson J. W.
 Woodward H. H.
 Wright Chas. S.
 Yale C. E.

BRIGHTON.
 Colwell John A.
 Gorham Chas. H.

CLARKSON.
 Rockwell W. L.

GATES.
 GREECE.
Charlotte P. O.

Davis Darius
 Farnam Patrick jr.
 Hinchey Franklin
 Harkin Peter
 Strickland J.
 Wilbur B. W.

HAMLIN.
 Fishbaugh John

HENRIETTA.
 Martin Robt.
 Phillips M. D.

Wadsworth A. S.
 Williams Marvin
 MENDON.
Honeoye Falls P. O.
 Blood Wm. H.
 Holden Alexander M.
 Park Edwin F.
 Shuart D. G.

OGDEN.
Adams Basin P. O.
 Colby Oscar P.
 Parmele Jas.
 Wheeler Stephen
Spenceport P. O.
 Brigham Chas.
 Goff F. M.

PARMA.
 Berridge Wm.
 Efner Charles
 Efner John V.

PENFIELD.
 Auchampaugh H.
 Chadsey John H.
 Watson J. F.

PERINTON.
Bushnell's Basin P. O.
 Hand J. C.
Fairport P. O.
 Chase W. P.
 Fonda Wm. F.
 Gleason F. B.
 Hulbert Thomas L.
 Wolcott H.

PITTSFORD.
 Gaskin Edward W.
 Malone Patrick
 Steele J. M.
 True Chas H.
 Vosburgh John B.

RIGA.
Churchville P. O.
 Bushnall J. H.
 Pierson E. D.

RUSH.
 Jeffords T. J.
North Rush P. O.
 Hart Henry B.

SWEDEN.
Brookport P. O.
 Beach H. N.
 Conant Francis J.
 Davis Milton H.
 Decker J. D.
 Kingsbury John H.
 Merritt W. S.
 Norton H. P.

WEBSTER.
 McMath Edward A.
 Wolcott C. P.
West Webster P. O.
 Dwinell Henry E.

WHEATLAND.
Mumford P. O.
 McNaughton Donald
Scottsville P. O.
 Ashby W. G.
 Moon Joseph F.

COMMISSIONERS OF DEEDS.

Abeles David
 Achilles H. L.
 Adams E. L.
 Adams E. N.
 Adams Jno. A.
 Adams Walter W.
 Adlington J. A.
 Agne John F.
 Aikenhead William
 Aldridge G. W.
 Alexander James
 Alexander John
 Allen C. M.
 Andrews J. Sherlock
 Andrews W. Y.
 Angevine Edward
 Angevine O. L.
 Angle James L.
 Armstrong Geo.
 Avery Frederick W.
 Babcock H. H.
 Baetzel J. G.
 Baker James F.
 Baker W. H.
 Bancker John
 Bardwell John M.
 Barker Hiram L.
 Barker John
 Barron M.
 Barry C. P.
 Bates Wm. M.
 Bausum Geo. F.
 Beach D. B.
 Beck L. P.
 Begy Geo. A.
 Benedict L. C.
 Bennett J. B.
 Bennett W. M.
 Benton G. A.
 Boardman H. E.
 Boss A.
 Bottum F. M.
 Bowen Jno. J.
 Boyd John F.
 Brewster H. P.
 Briggs Hamlet S.
 Brinker H.
 Brooks T.
 Brown Henry S.
 Brown Wm. R.
 Bruff Wm. W.
 Budd Daniel
 Budlong S. J.
 Buell Walter
 Burgess J. A.
 Burns Peter
 Burton Fredk.
 Cady W. W.
 Caring George
 Caring William
 Caulkins W. R.
 Cheney James E. jr.
 Child J. H.
 Clackner A. S.

Clark John jr.
 Clark Wm. H.
 Cochrane James
 Cole J. E.
 Cole Otis
 Connolly G. W.
 Cooke Martin W.
 Cowles John
 Cowley E. A.
 Crittenden DeL.
 Crouch Geo. W. jr.
 Cumings W. H.
 Cushman Abram H.
 Cutler J.
 Dake L. E.
 Dake W. H.
 Darrow Erastus
 Davis Chas. A.
 Davis Chas. R.
 Davis George P.
 Davis Hiram
 Davison C. C.
 Dean C. F.
 Decker G. C.
 Deuel J. W.
 Dewey D. M.
 Deyo J. M.
 Dickinson A. L.
 Dickinson P. P.
 Doane E. M.
 Drake Jno. N.
 Dransfield Thomas
 Draper George P.
 Drees August
 Dryer Rufus K.
 Dunning J. M.
 Eastman Joseph A.
 Ellis S. A.
 Elwood George M.
 Embry F. W.
 Emerson W. J.
 Emerson W. N.
 Enos B. Frank
 Evans James P.
 Fairman H. M.
 Fanning J. R.
 Farber G. J.
 Farber John P.
 Fee James
 Feely D. C.
 Felix Joseph
 Felsing J. A.
 Fichtner David G.
 Filon M.
 Fiske E. B.
 Fleckenstein Geo.
 Fleckenstein V. jr.
 Flynn Luke
 Foote N. jr.
 Forner Chas. J.
 Fox John T.
 Frank George F.
 Frauenberger G.
 Freeman B. F.

Frost Henry C.
 Fulton Levi S.
 Garlock J. S.
 Geddes Wm. B.
 Gerling Jacob
 Gibson L. S.
 Gillette L. H.
 Gillis Edgar
 Goddard Lewis J.
 Gorton Homer
 Gould R. K.
 Graebe Wm.
 Green Chas. A.
 Griffen E. H. C.
 Hackstaff N. T.
 Haggaman S. W.
 Hahn J. B.
 Hanford H. S.
 Harder J. N.
 Harris B. F.
 Harris George B.
 Harrison Henry
 Harrison J. M.
 Hathaway J. C.
 Healey P.
 Heavey M.
 Herzberger G.
 Hetzel C. F.
 Hills Isaac
 Hobbie C. R.
 Hoffman Joseph
 Hollister S. G.
 Hopwood Thomas H.
 Hovey L. H.
 Hubbell W. .
 Hulett T. W.
 Humphrey George H.
 Hungerford Thos. A.
 Hunt E. W.
 Husband Thos. B.
 Hyde Chas.
 Ireland W. H. H.
 Jackson G. F.
 Janes Wm.
 Jansen A.
 Jarrard R.
 Jayne A. S.
 Jeffords C. A.
 Jones Horace
 Jones R. D.
 Jones W. M.
 Jordan C.
 Jordan Jas. A.
 Kase Nicholas
 Kelly Lorenzo
 Kimball J. W.
 Kimmel A.
 King S.
 Klein John
 Knapp D.
 Lane F. C.
 Lansing R. H.
 Lauer F. C. jr.
 Lawson A.

Lawton A. L.
 Leavenworth Eli
 Lee G. P.
 Leidecker F.
 Leonard J. M.
 Leutchford A.
 Levet W. B.
 Leyden M.
 Linscott Frederick E.
 Loder W. A.
 Loeb's A. H.
 Mandeville Wesley
 Margrander Jacob
 Martin A. H.
 Mathews H. W.
 Mathews J. S.
 Mauder John
 McAlpine B. D.
 McConnell P.
 Mc Donald A.
 McDowell S. V.
 McGonegal H. B.
 McGorray J. A.
 McGuire J. Horace
 McIntyre Patrick
 McKelvey W. J.
 McLean H.
 McNaughton H. D.
 McPherson Wm. J.
 Merriman C. C.
 Messmer George
 Meyer John A.
 Michaels M.
 Miller A. J.
 Milliman R.
 Mitchell J. G.
 Montgomery Thos. C.
 Moore Wm. T.
 Mordoff M. C.
 Morris H. W.
 Morrison Thomas W.
 Morrison W. F.
 Moseley J. B.
 Moser Albert
 Moser A. M.
 Moshier I. V.
 Mudge W. R.
 Naylor J. W.
 Nellis J. H.
 Neville Thomas J.
 Newton L. M.
 Noyes M. W.
 Nutting Geo. H.
 Oatley E. T.
 O'Brien J. C.
 O'Dea M. F.
 O'Kelly Thomas P.
 Oliver William
 O'Regan John C.
 Osborn N. P.
 Otis Harrison G.
 Padley A.
 Palmer John P.
 Parsons Theron E.
 Peck W. F.
 Perry Chauncey
 Phillips S. G.

Pierce H. G.
 Pierce John
 Pierce N. A.
 Pierpont J. E.
 Pond Charles F.
 Pool Charles A.
 Potter C. E.
 Powers D. W.
 Pryor H. H.
 Quin John
 Rau Joseph
 Reibling A. J.
 Relyea L. F.
 Rew Francis S.
 Rhines Geo. W.
 Ripsom George E.
 Ritter F.
 Roberts G. Henry
 Robins S. P.
 Robinson R. D.
 Roe John E.
 Rogers F. D.
 Rogers W. H. H.
 Ross Lewin W. H.
 Rowley M. D.
 Sage W. L.
 Sargent A. H.
 Schermerhorn R. E.
 Schlegel F.
 Schoenberg M.
 Schooley R. H.
 Schutte J.
 Scrantom Edwih
 Scrantom E. H.
 Shaffer Wm. H.
 Shepherd Jesse
 Sheridan Wm. J.
 Shuart W. H.
 Simons J. C.
 Simpson Wm. T.
 Smith George
 Smith Henry F.
 Smith Thomas
 Spahn Jacob
 Stade F.
 Staermer J.
 Stanley J. W.
 Stape John
 Staples W. S.
 Stebbins J. W.
 Stephany John
 Stern Simon
 Sterrit Robert
 Stetzenmeyer F.
 Stevens O. H.
 Stewart F. J.
 St. John C. M.
 St. John W. H.
 Stone J. L.
 Stranahan J. R.
 Sulley Darell D.
 Sullivan H. J.
 Sullivan I.
 Terry S. H.
 Thomas B. F.
 Thomas George W.

Thompson W. M.
 Tippetts W. H.
 Tracy Clark D.
 Tracy J. T.
 Tracy W. H.
 Treadwell George
 Tubbs G. L.
 Tucker H. D.
 Tunell G. W.
 Turner Price T.
 Tuttle G. W.
 Tyler Charles M.
 Upton F. S.
 Van Ingen B.
 Van Voorhis John
 Van Voorhis Quincey
 Vay Rudolph
 Vose Frederick
 Vredenburgh E. H.
 Wagner Wm.
 Wagstaff A.
 Walker F. C.
 Walsh J. D.
 Walter J. A. P.
 Ward Joseph B.
 Ward L. A.
 Warner M. G. jr.
 Warner Wm. G.
 Watters J. E.
 Webb W. W.
 Webster E.
 Wegman J.
 Weider P.
 Weigel F. X.
 Wentworth Delos
 Wheeler A. G.
 White Henry E.
 White T. E.
 Whitley Frank
 Whitley John
 Whitley J. W.
 Whitney W.
 Whittlesey F. C.
 Whittlesey T. W.
 Whittlesey W. S.
 Widman Christian
 Wiedemann F. G.
 Wile Isaac A.
 Wile Julius M.
 Williams B. C.
 Williams C.
 Williams C. M.
 Wilson Geo. W.
 Wilson J. H.
 Wilson P. J.
 Wolf Abram E.
 Wolz Wm.
 Wood Daniel
 Wood W. R.
 Wooden L. M.
 Woodruff S. R.
 Woodward H. H.
 Woodward R.
 Woodworth C. C.
 Yanney David
 Yerkes W. H.

MILITARY.

Commander-in-Chief.....THE GOVERNOR *ex officio* (SAMUEL J. TILDEN.)

STAFF.

Adjutant General.—Major General Franklin Townsend.
Inspector General.—Brevet Major General John B. Woodward.
Commissary General of Ordnance.—Brigadier General Kilburn Knox.
Engineer-in-Chief.—Brigadier General Edgar M. Cullen.
Judge Advocate General.—Brigadier General Charles Hughes.
Surgeon General.—Brigadier General Austin Flint, Jr.
Quartermaster General.—Brigadier General Stewart S. Ellsworth.
Paymaster General.—Brigadier General Hermann Uhl.
Commissary General of Subsistence.—Brigadier General Charles H. Smyth.
Aides-de-Camp.—Colonels Charles Tracey, Latham C. Strong, James B. Pearsall, Thomas Stokes, Clifford A. H. Bartlett, William T. Pelton.

SEVENTH DIVISION N. Y. NATIONAL GUARD.

HEADQUARTERS AT ROCHESTER.

Seventh Division District comprises the Counties of Chemung, Schuyler, Steuben, Yates, Ontario, Wayne, Monroe and Livingston.

Commanding.....MAJOR GENERAL HENRY BRINKER.

STAFF.

Assistant Adjutant General and Chief of Staff.—Colonel Frederick Cook.
Inspector.—Colonel E. Bloss Parsons.
Chief of Artillery.—Colonel Joseph Erbelding.
Engineer.—Colonel William Graebe.
Judge Advocate.—Colonel George Raines.
Surgeon.—Colonel Jonas Jones.
Inspector of Rifle Practice.—Lieutenant-Colonel J. Renwick Campbell.
Ordnance Officer.—Lieutenant-Colonel Nathaniel Thompson.
Quartermaster.—Lieutenant-Colonel Robert E. Sherlock.
Commissary of Subsistence.—Lieutenant-Colonel Charles P. Bromley.
Aides-de-Camp.—Major George Fleckenstein, Major George W. Aldridge, Captain Henry N. Allen.

TWENTY-FIFTH BRIGADE.

HEADQUARTERS AT ROCHESTER.

Brigade District includes the Counties of Monroe, Wayne, Livingston, Ontario and Yates.

Commanding.....BRIGADIER GENERAL WILLIAM H. BRIGGS.

STAFF.

Assistant Adjutant General and Chief of Staff.—Lieut.-Col. Rufus K. Dryer.
Inspector.—Major George Hyland, Jr.
Engineer.—Major John Clark, Jr.
Judge Advocate.—Major Albert G. Wheeler.
Surgeon.—Major Charles Buckley.
Inspector of Rifle Practice.—Major Frank A. Schoeffel.
Ordnance Officer.—Captain Walter Weldon.
Quartermaster.—Captain William F. Balkam.
Commissary of Subsistence.—Captain Frederick Zimmer.
Aides-de-Camp.—Captain Charles E. Cunningham, Lieutenant Eugene Raines.

FIFTY-FOURTH REGIMENT.

HEADQUARTERS AT ROCHESTER ARSENAL.

Commanding.—Colonel George A. Begy.
Lieutenant-Colonel.—S. S. Eddy.
Major.—John N. Weitzel.

STAFF.

Adjutant.—1st Lieutenant A. H. Bruman.
Quartermaster.—1st Lieutenant Milton H. Smith.
Surgeon.—Major Julius Schmitt.
Assistant Surgeon.—Captain Charles E. McKelvey.
Commissary.—Captain Charles C. Meyer.
Inspector of Rifle Practice.—Captain E. S. Phelps.
Chaplain.—Captain Henry Anstice.
Sergeant-Major.—Fred Wegman.
Quartermaster Sergeant.—A. C. Burrough.
Commissary Sergeant.—William K. Toaz.
Ordnance Sergeant.—H. H. Smith.
Hospital Steward.—George F. Lenihen.
Drum Major.—Peter E. Sheridan.
Band Master.—Jacob Sauer.

COMPANY OFFICERS.

Co. A.— <i>Captain</i> , Michael Englert ; 1st <i>Lieutenant</i> , Frank Fehrenbach ; 2nd <i>Lieutenant</i> , George M. Schwartz.	Co. F.— <i>Captain</i> , Benjamin Ridley ; 1st <i>Lieutenant</i> , Fred. W. Eickart ; 2nd <i>Lieutenant</i> , ————.
Co. B.— <i>Captain</i> , William Wagner ; 1st <i>Lieutenant</i> , Peter Reinhard ; 2nd <i>Lieutenant</i> , Peter Hess.	Co. G.— <i>Captain</i> , Chris. Heilbronn ; 1st <i>Lieutenant</i> , Charles R. Pfeiffer ; 2nd <i>Lieutenant</i> , Henry N. Jacobs.
Co. C.— <i>Captain</i> , ———— ; 1st <i>Lieutenant</i> , Alfred Elwood ; 2nd <i>Lieu-</i> <i>tenant</i> , Louis E. Weed.	Co. H.— <i>Captain</i> , Ed. P. Brownell ; 1st <i>Lieutenant</i> , Henry B. Clark ; 2nd <i>Lieutenant</i> , A. D. McMasters.
Co. D.— <i>Captain</i> , Philip Mohr ; 1st <i>Lieutenant</i> , Peter Weirich ; 2nd <i>Lieu-</i> <i>tenant</i> , George Mohr.	Co. I.— <i>Captain</i> , Joseph Hesslinger ; 1st <i>Lieutenant</i> , William G. Junker ; 2nd <i>Lieutenant</i> , D. Crowley.
Co. E.— <i>Captain</i> , H. B. Henderson ; 1st <i>Lieutenant</i> , Edward Witherspoon ; 2nd <i>Lieutenant</i> , Edward F. Babbage.	Co. K.— <i>Captain</i> , Daniel O'Neil ; 1st <i>Lieutenant</i> , D. Kavanagh ; 2nd <i>Lieu-</i> <i>tenant</i> , ————.

BATTALION OF ARTILLERY.

25th Brigade.

ARMORY AT ARSENAL.

<i>Commanding.</i> —Col. Joseph Erbelding. <i>Adjutant.</i> —Lieut. John A. P. Walter. <i>Quartermaster.</i> —Lieut. Frederic Mil- ler, Jr. <i>Surgeon.</i> —Major George T. Benford. <i>Commissary.</i> —Lieut. Jno. Standenmeir Battery A.— <i>Captain</i> , E. J. Kelly ;	1st <i>Lieutenants</i> , John Brown, John W. Maser ; 2nd <i>Lieutenants</i> , E. D. Thomas, Milton Noyes. Battery B.— <i>Captain</i> , William Stein- hauser ; 1st <i>Lieutenant</i> , Robert Stirley ; 2nd <i>Lieutenants</i> , Peter Smith, Jacob Aebersold.
--	--

SEPARATE TROOP CAVALRY.

25th Brigade.

ARMORY AT ARSENAL.

Captain.—(Bt. Lieut. Col.) Frederick Miller ; 1st *Lieutenant*—John Rauber ;
2nd *Lieutenant*—John Hohenstein ; 3rd *Lieutenant*—John F. Boyd.

INDEPENDENT ORGANIZATIONS.

OLD THIRTEENTH.

ARMORY, MAIN ST. CORNER STONE.

Captain—F. A. Schoeffel.
First Lieutenant—William S. Foster.
Second Lieutenant.—Wm. Brownell.
Color Sergeant.—John Bollenbeck.
First Sergeant.—John Cawthra.
Second Sergeant.—Adolph Rodenbeck.
Third Sergeant.—J. H. Crampton.
Fourth Sergeant.—Henry Beilby.

MEAGHER ZOUAVES.

ARMORY, MAIN ST. CORNER STONE.

Captain.—Frank R. Ward.
1st Lieutenant.—Michael Quinlan.
2nd Lieutenant.—William Purcell.
1st Sergeant.—Thomas Devereaux.
2nd Sergeant.—John McAnalley.
3rd Sergeant.—Thomas Cunningham.
4th Sergeant.—George Collins.
Color Sergeant.—A. J. McFarland.

HENRY C. WISNER,

DECORATED CHINA, SILVER SETS,
 No. 78 STATE STREET.

ROCHESTER GAS LIGHT COMPANY,

Organized in 1848.

Capital Stock, - - \$700,000.

OFFICE AND WORKS:

Cor. MUMFORD ST. and GENESEE RIVER,

DIRECTORS.

LEVI A. WARD, Prest., THOS. C. MONTGOMERY, ISAAC HILLS,
JOSEPH FIELD, PATRICK BARRY, LOUIS CHAPIN,
DON A. WATSON, GILMAN H. PERKINS, GEO. ELLWANGER.

EXECUTIVE COMMITTEE.

LOUIS CHAPIN, Chairman, DON A. WATSON,
LEVI A. WARD, PATRICK BARRY.

HENRY T. ROGERS, Secretary and Treasurer.

TO CONSUMERS.

The following explanations will enable any person to understand the process of ascertaining the Registry of the Gas Meter, and by making observations every day, or at short intervals, to satisfy himself that the meter registers with uniform accuracy the amount of gas that passes through it. The following diagrams show the "Indexes" seen on the front of every meter.

EXPLANATION OF INDEX.

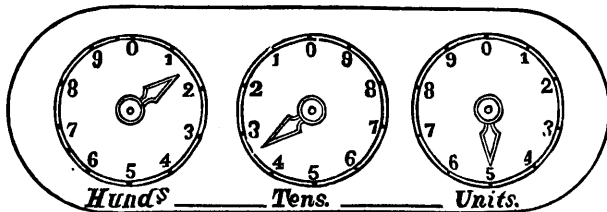

The figure or division on the different faces of the index indicates as follows, viz: On the Right Hand Face, *Hundreds*, as 100, 200, 300 cubic feet, &c.; on the Middle Face, *Thousands*, as 1,000, 2,000, 3,000 cubic feet, &c.; on the Left Hand Face, *Tens of Thousands*, as 10,000, 20,000, &c., and in this way multiplying by 10 for every additional face.

TO TELL THE STATE OF THE METER.—Look at the *left hand* face of the Index, and set down the figure of *least* value next the hand, which on the diagram is 1. Next look at the *middle* face, and as before set down the figure of the *least* value next the hand, which on the diagram is 3. Next upon the *right hand* face, take the same relative figure, which is 5, and you have the figures 1, 3, 5, to which last figure add two ciphers to represent hundreds, and the sum, 13,500, is shown to be the present state of the meter. If a previous observation has been taken, subtract the state of the meter at *that* time from the *present* state, and you have the amount consumed in the interval.

 In case of the failure of the gas from any cause, immediate notice of the fact should be left at the Company's Office.

CITIZENS' GAS COMPANY.

—◆◆◆—
INCORPORATED IN 1872.

CAPITAL, - - - \$500,000

—◆◆◆—
DIRECTORS.

GEORGE J. WHITNEY,
ROSWELL HART,
GEORGE E. MUMFORD,
MORTIMER F. REYNOLDS,
JAMES BRACKETT.

OFFICERS.

PRESIDENT, - - - - - GEORGE J. WHITNEY
SECRETARY AND TREASURER, - - - WILLIAM H. WARD
SUPERINTENDENT, - - - - - CLEMENT A. WHITE

THIS COMPANY supplies all Gas Consumers on the East Side
of the Genesee River exclusively.

—◆◆◆—
GENERAL OFFICE,

15 North St. Paul Street,
GAS WORKS AT VINCENT PLACE BRIDGE.

COKE AND TAR FOR SALE.

All payments for Gas or Coke, applications for change, complaints for irregularities, &c., should be made at the General Office, No. 15 NORTH ST. PAUL STREET.

TRADERS' NATIONAL BANK,

OF ROCHESTER, N. Y.

37 West Main St., cor. Exchange,

(UP STAIRS.)

Capital, - - - \$250,000
Surplus and Profits, 200,000

Incorporated as a State Bank, 1859;

Re-organized as a National Bank, 1865.

OFFICERS.

SIMON L. BREWSTER, - - - *President.*
GEO. C. BUELL, - - - *Vice-President.*
HENRY C. BREWSTER, - - - *Cashier.*

DIRECTORS.

SIMON L. BREWSTER, CLINTON ROGERS,
GEORGE C. BUELL, HENRY BREWSTER,
HENRY S. POTTER, SIDNEY B. ROBY,
BYRON D. McALPINE, HENRY C. BREWSTER,
MELANCTON LEWIS, OF VICTOR.

CITY BANK

OF ROCHESTER.

34 State Street, - Rochester, N. Y.,

Successor to the

FIRST NATIONAL BANK OF ROCHESTER,

Which was organized in 1864, succeeding the OLD ROCHESTER CITY BANK, incorporated 1836.

CAPITAL, - - \$200,000.

THOMAS LEIGHTON, - - - President.

CHAS. E. UPTON, - - - Cashier.

Assistant Cashier—W. S. SHERMAN.

Discount Clerk—WILLIAM J. ASHLEY.

Bookkeeper—HENRY BARNARD.

*Assistant Bookkeepers—F. C. FENN, L. S.
HOYT, JR.*

Assistant Teller—THOMAS HAWKS, JR.

Clerk—C. F. TORRANCE.

DIRECTORS.

THOMAS LEIGHTON,
EZRA M. PARSONS,
J. B. PERKINS,

J. E. PIERPONT,
M. R. LEIGHTON,
WM. CHURCHILL,

W. J. ASHLEY,
W. S. SHERMAN,
C. E. UPTON.

DO A GENERAL BANKING BUSINESS.

Collections Made in All Parts of the United
States, at Low Rates.

N. Y. Correspondent—CENTRAL NATIONAL BANK.

ROCHESTER SAVINGS BANK,

Cor. West Main and Fitzhugh Streets, Rochester, N. Y.

(Incorporated April 21, 1831.)



OPEN DAILY (Sundays and legal holidays excepted) from 10 A. M. to 3 P. M.,
and on the last day of each month from 7 to 8 P. M.

OFFICERS.

ELIJAH F. SMITH,	- - -	President.	EUGENE A. SHEPARDSON,	Paying Cashier.
ISAAC HILLS,	- - -	First Vice-President.	THOMAS H. HUSBAND,	- Receiving Cashier.
WILLIAM H. CHENEY,	- - -	Second Vice-President.	HENRY S. HANFORD,	Bond and Mort. Clerk.
EDWARD R. HAMMATT,	- - -	Sec'y and Treasurer.	LLEWELLYN H. VAN ZANDT,	Book-Keeper.
ISAAC HILLS,	- - -	Attorney.	GEORGE EASTMAN,	1st Assist't Book-Keeper.
EDWARD HARRIS,	- - -	Counsel.	EDWARD J. RAYMOND,	ad " "
			EDWARD L. RAYMOND,	- - Clerk.

TRUSTEES.

ELIJAH F. SMITH,
WILLIAM H. CHENEY,
ISAAC HILLS,
ROSWELL HART,
MORTIMER F. REYNOLDS,

JAMES BRACKETT,
ADDISON GARDINER,
NHEMIAH B. NORTHROP,
CHARLES F. SMITH,
GEORGE J. WHITNEY,

EDWARD HARRIS,
HOBART F. ATKINSON,
GEORGE E. MUMFORD,
CHARLES C. MORSE,
GILMAN H. PERKINS.

MONROE COUNTY SAVINGS BANK,

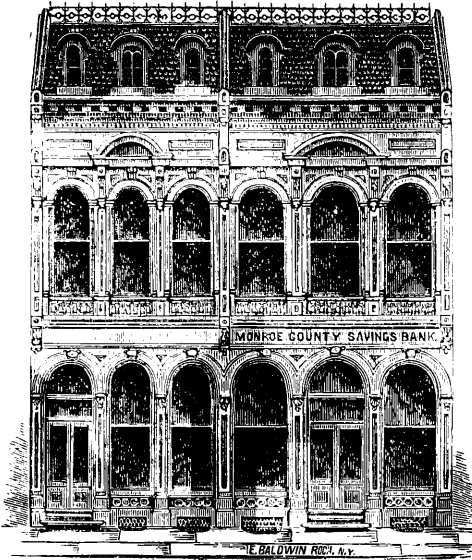

INCORPORATED 1850.

No. 31 State Street, Rochester, N. Y.

OFFICERS.

President,	- - - - -	GEORGE G. CLARKSON.
Vice-Presidents,	- - - - -	LOUIS CHAPIN, CHAS. J. HAYDEN.
Secretary and Treasurer,	- - - - -	JONATHAN E. PIERPONT.
Attorney,	- - - - -	JAMES L. ANGLE.

TRUSTEES.

NEHEMIAH OSBURN,	LOUIS CHAPIN,	AMBROSE CRAM,
WILLIAM N. SAGE,	CHARLES H. WILLIAMS,	JAMES L. ANGLE,
ALVAH STRONG,	WILLIAM CHURCHILL,	WILLIAM ALLING,
MARTIN BRIGGS,	JOSEPH CURTIS,	EZRA M. PARSONS,
LEWIS SELYE,	CHARLES F. HAYDEN,	CYRUS F. PAINE,
AMON BRONSON,	BENJAMIN M. BAKER,	OSCAR CRAIG,
GEORGE ELLWANGER,	GEORGE G. CLARKSON,	JAMES E. BOOTH.

MECHANICS' SAVINGS BANK,

OF ROCHESTER, N. Y.

EXCHANGE STREET, building formerly occupied by Commercial Bank.

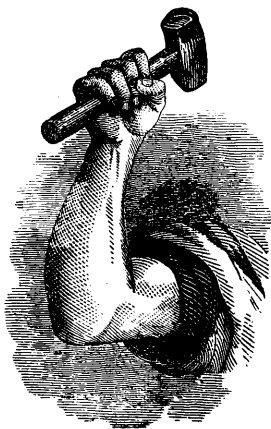

OFFICERS.

PRESIDENT,	- - - - -	PATRICK BARRY.
VICE-PRESIDENTS,	SAM'L WILDER, HAMLET D. SCRANTOM.	
SECRETARY AND TREASURER,	- - - - -	JOHN H. ROCHESTER.
ATTORNEY,	- - - - -	FRED. A. WHITTLESEY.

TRUSTEES.

FRED'K A. WHITTLESEY,	PATRICK BARRY,	ABRAM S. MANN,
HAMLET D. SCRANTOM,	GEORGE G. COOPER,	CHAUNCEY B. WOODWORTH,
SAMUEL WILDER,	JAMES M. WHITNEY,	SAMUEL SLOAN,
EDWARD M. SMITH,	OLIVER ALLEN,	JOHN J. BAUSCH.
JONATHAN H. CHILD,		

This Bank is open for business during the usual Bank Hours, 10 A. M. to 3 P. M.

Interest on Deposits will be allowed at the rate of SIX PER CENT. per annum on all sums not exceeding \$5,000.

to be computed from the first day of the calendar month on or succeeding the date of deposit, to the first day of the calendar month in which it is withdrawn.

Deposits of ONE DOLLAR and upwards will be received.

EAST SIDE SAVINGS BANK

OF ROCHESTER, N. Y.

OFFICERS.

PRESIDENT,

HENRY S. HEBARD.

VICE-PRESIDENTS,

MICHAEL FILON,

HECTOR McLEAN.

SECRETARY AND TREASURER,

P. BRYAN VIELE.

ATTORNEY,

JOHN M. DAVY.

TRUSTEES.

ISAAC F. QUINBY,
HENRY S. HEBARD,
HIRAM DAVIS,
MICHAEL FILON,
WM. N. EMERSON,
HECTOR McLEAN,
EDMUND OCUMPAUGH,
JAMES VICK,
TRUMAN A. NEWTON,



J. MOREAU SMITH,
WM. A. HUBBARD,
ARAUNAH MOSELEY,
ABNER GREEN,
ERASTUS DARROW,
HENRY LAMPERT,
LOUIS ERNST,
LUCIUS S. MAY.

This Bank having secured desirable rooms in the WASHINGTON HALL BLOCK, corner of Main and Clinton Streets, has opened under the most favorable circumstances, and has already a very liberal deposit.

It is the intention of its Managers to accommodate business men as well as those who wish to lay up their small gains, and to this end they promise their untiring efforts.

Bank Hours from 10 A. M. to 3 P. M., and from 7 to 9 Saturday evenings.

Interest on Deposits will be computed at 6 per cent. from the date of deposit to the date of withdrawal; but no interest will be allowed on any sum on deposit less than thirty days.

Money Loaned on Bond and Mortgage and Approved Collaterals.

THE
DIRECTORY OFFICE,

(ESTABLISHED IN 1869.)

114 POWERS' BUILDINGS,

ROCHESTER, N. Y.

BRANCH OFFICE: }
452 Main Street, Worcester, Mass. }

ROCHESTER DIRECTORY,
Price, \$3.

NEWTON DIRECTORY,
Price, \$1.50.

WORCESTER DIRECTORY.
Price, \$2.

*Besides the Publications issued from this office
are kept on hand*

DIRECTORIES OF THE PRINCIPAL CITIES

IN THE UNITED STATES,

For Sale at Publishers' Prices.

Persons who do not wish to be at the expense of buying Directories, will be furnished with Lists of Business Men in any trade or profession in any state, at reasonable rates.

☞Circulars Printed, enclosed and Mailed.

CANVASSING

Done for Committees, Corporations and others, accurately and at short notice.

D., A. & Co. having been engaged for sixteen years in business of this nature, have facilities and experience for doing well whatever work is entrusted to them.

DREW, ALLIS & CO.,

Publishers and Statisticians,

CHARLES C. DREW, }
GARDNER S. ALLIS, }

114 Powers' Buildings.

THE
SAFE DEPOSIT COMPANY
OF ROCHESTER.

MONROE COUNTY SAVINGS BANK BUILDING,
31 State Street.

Incorporated by Act of Legislature, March 30th, 1868.

—————
 CAPITAL, - - - - - \$100,000
 Additional Liability of Stockholders, - - - - - \$100,000
 —————

DIRECTORS.

WILLIAM N. SAGE,	EZRA M. PARSONS,
WILLIAM CHURCHILL,	H. D. SCRANTOM,
S. L. BREWSTER,	B. M. BAKER,
GEORGE G. CLARKSON,	J. E. PIERPONT,
C. E. UPTON,	GEO. ELLWANGER,
C. J. HAYDEN,	JOSEPH CURTIS,
LOUIS CHAPIN,	J. MOREAU SMITH,
A. McVEAN,	CHAS. P. BOSWELL.
WILLIAM J. ASHLEY.	

WILLIAM N. SAGE,	President.
J. E. PIERPONT,	Vice-President.
WILLIAM J. ASHLEY,	Secretary.

This Company will store and INSURE absolutely against fire and robbery, at a trifling expense,

Government & other Bonds, Stocks & Securities,
AND SILVER PLATE,
—IN THEIR—

LARGE STEEL-LINED VAULT,

In a fire-proof building, guarded day and night. Storage for Valuable Papers, Silver Ware, Jewelry, Clothing, Furniture, and valuable property of any description.
The Company have also provided inside of the Vaults, SMALL SAFES, which are offered for rent at low rates.

NON-LIABILITY OF BANKS.

The Banks disclaim all responsibility for any Cash Boxes or Securities left with them for safe keeping.

With this Company, the depositor pays for and obtains a reliable security.

One Dollar will Insure the Safety of a \$1,000 Bond for One Year.

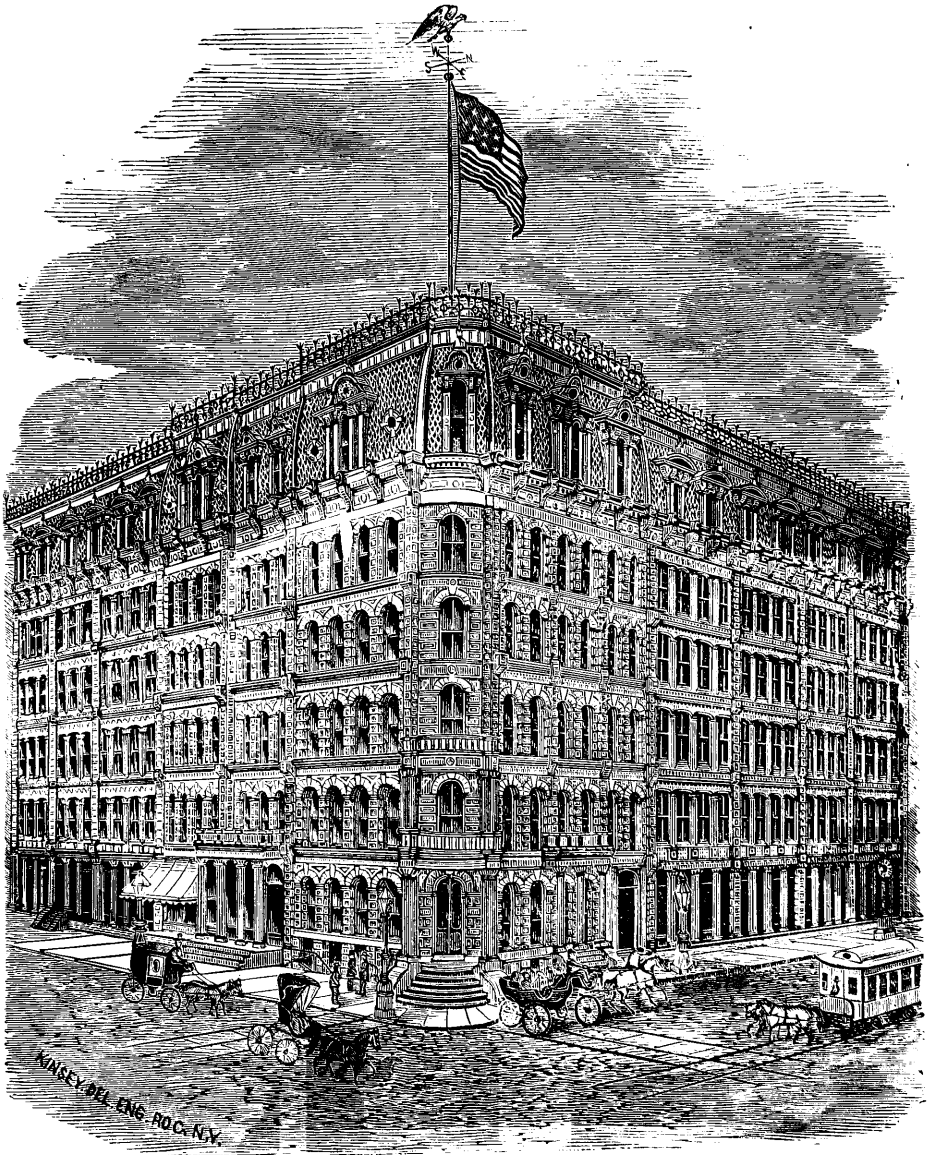

WINSEY DEL. ENG. ROC. N.Y.

POWERS' COMMERCIAL FIRE-PROOF BUILDING.

D. W. POWERS'
BANKING HOUSE.

ESTABLISHED IN 1850

WEST MAIN STREET, CORNER STATE.

Deals in Government Securities, State Stocks, City and County Bonds, &c., &c.
Also Proprietor of a BEAUTIFUL ART GALLERY, Nos. 161, 163, 165, 168,
170 and 172 Powers' Buildings, Fifth Floor. Open Daily, from 9 A. M. to 5 P. M.

ERICKSON, JENNINGS & MUMFORD,

(Union Bank,)

BANKERS,

DEALERS IN

Government Securities and Commercial Paper.

No. 25 STATE STREET, - ROCHESTER, N. Y.

AARON ERICKSON.

GEO. E. JENNINGS.

GEO. E. MUMFORD.

STETTMEYER, TONE & CO.,

BANKERS,

No. 8 State Street, - - - Rochester, N. Y.

DEALERS IN

GOVERNMENT SECURITIES,

Negotiate Loans, Discount Commercial Paper, etc.

Gold, Silver, Uncurrent Money, &c., &c. Exchange on and Passage Tickets to and from all parts of Europe. Interest paid on Special Deposits.

PARTICULAR ATTENTION PAID TO COLLECTIONS. We respectfully solicit your patronage.

AGENTS FOR ALL THE PRINCIPAL STEAMSHIP LINES.

BANK OF ROCHESTER,

No. 41 State Street,

CHAS. H. CHAPIN, - - - President.

J. MOREAU SMITH, - - - Vice-President.

GEO. M. SWEET, - - - Cashier.

DIRECTORS

WILLIAM KIDD,
CHAS. J. HAYDEN,
J. MOREAU SMITH,
DE L. CRITTENDEN,

CHAS. H. CHAPIN,
GEORGE M. SWEET,
CHAS. C. MORSE,

CHAS. F. SMITH,
H. F. ATKINSON,
GEO. H. THOMPSON,
H. C. ROBERTS.

Particular Attention Paid to Collections.

ÆTNA

INSURANCE COMPANY, - HARTFORD, CONN.

Paid Up Cash Capital,	-	-	\$3,000,000
Assets, Jan. 1, 1876,	-	-	Over \$6,850,000

PHŒNIX

INSURANCE COMPANY, - HARTFORD, CONN.

Paid Up Cash Capital,	-	-	\$600,000
Assets, Jan. 1, 1876,	-	-	Over \$1,900,000

SPRINGFIELD

FIRE AND MARINE INSURANCE COMPANY.

Paid Up Cash Capital,	-	-	\$700,000
Assets, Jan. 1, 1876,	-	-	Over \$1,390,000

HOWARD

INSURANCE COMPANY, - - - NEW YORK.

Paid Up Cash Capital,	-	-	\$500,000
Assets, Jan. 1, 1876,	-	-	Over \$815,000

THE EQUITABLE

Life Assurance Society of the United States.

NEW YORK LIFE

INSURANCE AND TRUST COMPANY.

L. A. & L. F. WARD,

Nos. 2 and 4 EXCHANGE PLACE.

GENERAL INSURANCE AGENCY,

—OF—

DANL. W. BUSH,

No. 8 Exchange Place, Rochester, N. Y.

Queen Insurance Co., of London,

Cash Assets, over \$12,000,000

Guardian Assurance Co., of London,

Cash Assets, over \$15,000,000

Commercial Union Assurance Co., of London,

Cash Assets, over \$13,000,000

Hamburg-Bremen, of Germany,

Cash Assets, over \$3,000,000

Germania Fire Ins. Co., of New York,

Cash Assets, - \$2,000,000

Providence Washington Ins. Co., of R. I.,

Cash Assets, - \$800,000

Atlantic Fire Ins. Co., of New York,

Cash Assets, - \$500,000

DAN'L W. BUSH, Agent,

No. 8 EXCHANGE PLACE, - - - ROCHESTER, N. Y.

New York and Pennsylvania Department.

BRITISH AMERICA

ASSURANCE COMPANY, - TORONTO, ONTARIO.

INCORPORATED 1838.

Gold Assets, May 1st, 1876, - - - Over \$1,000,000

BANGOR

INSURANCE COMPANY, - - - BANGOR, ME.

Paid Up Cash Capital, - - - - - \$200,000

Assets, May 1st, 1876, - - - - - Over \$350,000

ALLIANCE

INSURANCE COMPANY, - - - BOSTON, MASS.

Paid Up Cash Capital, - - - - - \$200,000

Assets, May 1st, 1876, - - - - - Over \$325,000

FOR AGENCIES,

APPLY TO

C. L. STOWELL, Manager for New York and Pennsylvania.

No. 132 Powers' Building, Rochester, N. Y.

GEORGE SAVARY, Special Agent for New York,

C. F. KNAPP, Special Agent for Pennsylvania,

HENRY E. BALL, Fire Inspector.

THE STRONGEST AGENCY IN WESTERN NEW YORK.

ROWLEY & HAYES,
 INDEPENDENT
NON-BOARD FIRE INS. AGENCY

No. 8 State Street, Rochester, N. Y.

REPRESENTING ONLY FIRST-CLASS COMPANIES.

Over One Hundred Million Dollars Capital.

BEFORE RENEWING YOUR POLICIES, OR PLACING NEW RISKS, you will certainly find it for your interest to call on us.

AGENCY OF THE

Mutual Life Insurance Company, of New York,

The only Life Insurance Company whose policies become self-sustaining or double in value.

POLICY No. 1398.	PERMIUM, \$102.	STATEMENT.	ORDINARY LIFE.	AMOUNT, \$5,000.
	Additions Purchased by Annual Cash Returns,		\$5,790 38	
	Thirty-one Premiums paid, \$102 each,		3,162 00	
	Excess of Additions over Premiums paid,		<u>\$2,628 38</u>	
Present value of Policy and Additions as a Death Claim,			\$10,790 38	
\$102 Invested Annually for 31 years, at 6 per cent. Compound Interest, would yield			9,168 76	
In favor of investment in Mutual Life Ins. Co., of New York,			<u>\$1,621 62</u>	

C. T. AMSDEN.

F. J. AMSDEN.

C. T. AMSDEN & SON,
INSURANCE,

Office under Powers' Banking House,

Corner West Main and State Streets.

WAKEMAN Y. ANDREWS, Surveyor.

Agents for CUNARD LINE OF STEAMERS.

F. J. AMSDEN,

BANKER,

UNDER POWERS' BANKING HOUSE,

Government Securities, Gold,

DRAFTS ON ALL PARTS OF EUROPE.

WATERTOWN FIRE INSURANCE CO.,

OF WATERTOWN, N. Y.

Cash Capital,
\$200,000.00.



Assets, over
\$694,075.63.

Rates reasonable, risks absolutely safer, and Company much stronger than companies doing a general business. Insures nothing more hazardous than PRIVATE RESIDENCES, BARNs, and their contents. Insures against loss or damage by FIRE and LIGHTNING.

We also do a general business of FIRE AND LIFE INSURANCE in good reliable Companies. Please call and get our terms.

WELCH & FIRMAN, Agents,
No. 12 Smith's Block, Rochester, N. Y.

New Jersey Mutual Life Insurance Co.

OF NEWARK, N. J.

ASSETS, Jan. 1st, 1876, over - \$2,000,000.

Insures on all the popular plans of the day. Its Decennial Endowment Policies are largely in demand, giving as they do, a 7 to 9 per cent. Compound Interest Investment.

For further information, inquire of

A. J. GORDON,

Manager for Western New York,

Branch Office, 18 West Main Street, - Rochester, N. Y.

-OR-

H. W. BALDWIN, Superintendent,

Drexel Building, Wall Street, - - - NEW YORK CITY.

BROOKLYN

LIFE INSURANCE COMPANY,

OF NEW YORK.

Assets, - - - - - \$2,500,000

Surplus, Jan. 1, 1876, - 279,000

Cash Surrender Value endorsed on every Participating Policy.

Agents for Monroe and adjoining Counties wanted,
who can make very favorable terms.

A. I. HULETT, - - - - **General Agent,**
Office, 45 Powers' Block, Rochester, N. Y.

THE COMMERCIAL AGENCY,
John McKillop & Co.,

No. 6 State Street, - ROCHESTER, N. Y.

ASSOCIATE OF

McKILLOP & SPRAGUE CO., N. Y.

Established January, 1842.

Associate and Branch Offices in all the Principal Cities. Claims Collected throughout the United States, Canada and Europe.

H. G. ARNOLD,

Patentee and Manufacturer of the

Crescent Sash Lock,

ALSO, DEALER IN

REAL ESTATE,

Harvard Street, cor. Rowley, - Rochester, N. Y.

W. R. CAULKINS.

C. C. GOVE.

W. R. CAULKINS & CO.,

32 East Main St., Rochester, N. Y.

AUCTION AND COMMISSION HOUSE,

We have filed bonds with the State Controller of \$10,000,
that we will do justice to Consignors.

OUR INSURANCE POLICIES COVER ALL GOODS LEFT ON CONSIGNMENT.

TEMPLE OF FANCY,

No. 110 State Street.

M. L. HUGHES,

DEALER IN

CHILDREN'S CARRIAGES, TOYS,

FANCY GOODS, NOTIONS, GLASS WARE, ETC.

Willow and Rattan Ware and Baskets of All Kinds.

TEN PER CENT. FARM MORTGAGES.

McPHAIL & JONES,

Foreign and American Financial Agents,

Principal Office, 39 Reynolds' Arcade,

ROCHESTER, N. Y.

Investments of Foreign and American Capital made in all parts of the United States.

E. McPHAIL.

W. MARTIN JONES, Attorney at Law.

H. H. McPHAIL.

P. S. WILSON,

General Insurance Agency,

EUROPEAN STEAMSHIP TICKETS FOR SALE,

—VIA. THE—

National Line,

No. 1 Reynolds' Arcade, - - Rochester, N. Y.

MONEY

ADVANCED ON

DIAMONDS, WATCHES, AND ALL KINDS OF PERSONAL PROPERTY,

At Lowest Rates.

Only Licensed Pawnbroker having Burglar and Fire-Proof Safe.

GOLD and SILVER WATCHES for Sale Cheap.

WHEELER'S LOAN OFFICE,

Nos. 6, 6 1-2 and 8 MASONIC BLOCK,
COR. EXCHANGE AND WEST MAIN STS., }

ROCHESTER, N. Y.

N. A. PIERCE,

REAL ESTATE

AND INSURANCE BROKER.

A FULL LIST OF

Houses, Lots and Country Property

No. 41 ARCADE,

B. C. WILLIAMS, Attorney.

ROCHESTER, N. Y.

Titles examined, and Suits conducted in any Court.

McLEAN & JOHNSON, GENERAL FIRE INSURANCE,

Nos. 26 and 27 Arcade Hall, Rochester, N. Y.,

(HEAD OF NORTH STAIRS.)

Imperial and Northern Insurance Companies, - - - -	\$23,000,000
Manhattan Fire Insurance Company, New York, - - - -	800,000
Orient Fire Insurance Company, Hartford, - - - -	767,000
Merchants' Fire Insurance Company, Providence, - - - -	433,000

REAL ESTATE BROKERS,

No. 33 Arcade, West Gallery, Rochester, N. Y.

For Sale, Purchase, and Exchange on Commission,

REAL ESTATE OF ALL KINDS,

SPECIAL ATTENTION GIVEN TO

Renting, Collection of Rents and Care of Property.

First-Class Mortgages Bought.

GEO. DEVENPORT.

GEO. W. TUTTLE.

\$10,000 Assurance for \$60 Premium.

The only Life Insurance Company in the world that GRADES Sound or Insurable Risks according to the INSURABLE CHARACTER of each, as in Fire Insurance, is the

American Popular Life Ins. Co.,

ORGANIZED 1866.

Paid Up Capital, - - - -	\$300,000
Total Assets to every \$100 of Liabilities, - - - -	\$163

**GEORGE BRECK, General Agent, 22 Exchange St. (over Bank of Monroe),
ROCHESTER, N. Y.**

\$5,000 Assurance for \$35 Premium! to Best Grade Risks.

J. B. WARD.

CURTIS CLARK.

WARD & CLARK, General Insurance.

Represent Prominent Non-Board Companies.

Careful and Prompt Attention to Business Promised. Losses Settled
at this Agency.

31 Powers' Block, First Floor, Over Store 72 West Main Street.

REIBLING & OLCOTT,

(A. J. REIBLING & CO.)

GENERAL INSURANCE.

Nearly \$40,000,000 Capital Represented.

OFFICE, 62 EAST MAIN STREET,

OPPOSITE OSBURN HOUSE,

ROCHESTER, N. Y.

Continental Life Insurance Company,

OF NEW YORK.

W. H. MONTGOMERY,

New York State Manager,

Office, 13 Powers' Block, - ROCHESTER, N. Y.

W. F. HOLMES & CO.'S

(JOHN F. HOLMES.)

GENERAL INSURANCE AGENCY,

OFFICE, Over 33 West Main Street,

No. 2 Second Floor, Old Masonic Hall Block, Rochester, N. Y.

*One of the Strongest Agencies in the State.*Travelers should procure **ACCIDENT TICKETS** before commencing a journey—
\$3,000 FOR 25 CENTS A DAY.

☞ Losses equitably adjusted and promptly paid at our office.

W. F. HOLMES & CO., Agents.

C. M. TYLER,

CENTRAL FIRE

INSURANCE OFFICE

No. 40 East Main Street, cor. Water Street,

ROCHESTER, N. Y.

 Insurance at Reasonable Rates. All Losses Honorably and Promptly Paid.

J. H. PUTNAM.

W. J. GRAVES.

PUTNAM & GRAVES, ARCHITECTS, ROCHESTER, N. Y.

95 Powers' Block, - - - Third Floor.

1876.

ESTABLISHED IN

1828.

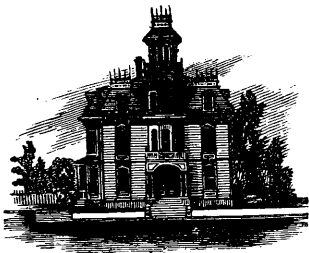

ISAAC LOOMIS,
Practical Architect,
—AND—
SUPERINTENDENT OF BUILDINGS,
Office, No. 44 Smith's Block,
ROCHESTER, N. Y.

Plans and Specifications of Buildings made to order.

Reference, over forty years experience.

C. KNEBEL, ARCHITECT

Nos. 64 and 65 Reynolds' Arcade,

ROCHESTER, N. Y.

GEORGE W. THOMAS, ATTORNEY AT LAW, 109 Powers' Block (Third Floor), Rochester, N. Y.

I shall make a specialty of **Mercantile Collecting**, charging for the same as follows:

For Simple Collection by Letter, - - - - - 10 Per Cent.
Other Collections, - - - - - 15 to 25 Per Cent.

☞ Claims placed in my hands will receive prompt attention.

REFERENCES { Hon. JEROME FULLER, Monroe Co. Judge.
Hon. J. M. DAVY, Ex-District Attorney.

JOSEPH D. HUSBANDS,
COUNSELLOR AT LAW,
NOTARY PUBLIC,

Register in Bankruptcy and U. S. Commissioner, U. S. Master and Examiner
in Chancery, in both District and Circuit Courts.

No. 143 Powers' Buildings [Fourth Floor],

ROCHESTER, N. Y.

J. H. JEFFRES,

C. S. BAKER,

ATTORNEYS AT LAW,

Nos. 116 and 118 POWERS' BUILDINGS,

(Third Floor, South Hall),

ROCHESTER, N. Y.

EDWARD WEBSTER,

Attorney and Counsellor at Law,

Commissioner for the State of California,

No. 82, POWERS' BUILDINGS, ROCHESTER, N. Y.

Third Floor, Front Room, near Main Stairway.

D. C. HYDE,

ATTORNEY AT LAW,

91 and 93 POWERS' BUILDINGS,

Third Floor, East Hall,

- ROCHESTER, N. Y.

EZRA R. ANDREWS,

LAW BLANK PUBLISHER,

BOOK AND JOB PRINTER,

Dealer in Blank Books and Stationery,

No. 1 AQUEDUCT STREET,

ROCHESTER, N. Y.

Established 1849.

E. R. ANDREWS

HAS THE MOST COMPLETE

BOOK AND JOB PRINTING OFFICE

· IN THIS PART OF THE STATE.

—◆◆◆—
ALL CLASSES OF

PRINTING

DONE ACCURATELY AND ECONOMICALLY.

—◆◆◆—
A LARGE BINDERY ATTACHED.

—◆◆◆—
Blank & Record Books

ON HAND AND MADE TO ORDER.

—◆◆◆—
No. 1 AQUEDUCT STREET,

ROCHESTER, N. Y.

☞ *Agent for the Type Writer.*

J. EDW. LINE,

DENTIST,

No. 50, West End of Smith's Block, } - ROCHESTER, N. Y.
 Directly Opp. Moore & Cole's, }

OFFICE HOURS: 8 A. M. to 5 P. M.

The EYE and EAR.

DR. W. P. FOWLER,
OCULIST AND AURIST,

No. 27 North Fitzhugh Street,

ROCHESTER, N. Y.

Attends exclusively to the Medical and Surgical treatment of Diseases of the EYE and EAR. Hours, 9 to 12 A. M., and from 1 to 4 P. M.

WILLIAM L. INGRAHAM,

MANUFACTURER OF

KEDZIE WATER FILTERS,

No. 77 Exchange St., Rochester, N. Y.

These Filters PURIFY WATER for Drinking Cooking, and Mechanical purposes, rendering all soft water PERFECTLY PURE and CLEAR as Crystal.

Filters and Coolers combined, for Shops, Counting Rooms and Offices. Also, Refrigerators, Ice Boxes, Coolers, &c.

FILTERS RE-PACKED.



E. F. WILSON.

P. H. SMITH

WILSON & SMITH,

DENTISTS,

No. 196 Powers' Block, Fifth Floor,

ROCHESTER, N. Y.

We pay particular attention to the New and Permanent way of **FILLING AND SAVING THE TEETH.** Look to the six year old Molars of your children; they need early attention.

☞ DR. WILSON has returned for a permanent residence in the City.

EZRA B. BOOTH.

HENRY G. BOOTH.

E. B. BOOTH & SON,

DEALERS IN

Silver Ware, Watches, Jewelry, Clocks,

WATCHMAKERS' AND JEWELERS' MATERIALS, TOOLS, &c.,

No. 5 STATE STREET, - Rochester, N. Y.

Agents for the celebrated "Borel & Courvoisier Watches," and Lazarus & Morris' Perfected Spectacles. Silver Spoons made to order. Repairing neatly done.

LOUIS WALLDORF,

DEALER IN

WATCHES, JEWELRY,

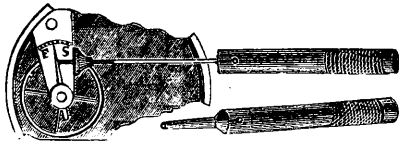

Silver and Silver Plated Ware,

SPECTACLES, &c.

We pay personal attention to our Repairing.

Also patentee and manufacturer of Walldorf's Patent

Combined WATCH REGULATOR AND KEY; en-

abling one to wind and also to regulate their watch with perfect safety. Call and see one.

54 E. MAIN STREET, cor. S. ST. PAUL, - ROCHESTER, N. Y.

W. MERK,

DEALER IN

GERMAN AND ENGLISH

Books, Periodicals, Papers,

STATIONERY, PICTURES, POCKET BOOKS, ALBUMS, &c.

No. 5 NORTH CLINTON STREET,

Washington Hall Block,

ROCHESTER, N. Y.

ESTABLISHED 1860.

GOLD AND SILVER PLATING

Over 14 State St., Gould Building.
ROCHESTER, N. Y.

TABLE WARE

OF EVERY DESCRIPTION,

Plated or Re-plated.

PLATING on all KINDS OF METAL
J. M. MORRIS.

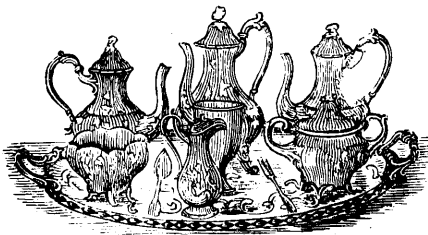

Manufacturers, Jewelers, Private Families and Hotel Proprietors are respectfully invited to give us a call.

HENRY ROSENBERG.

DAVID ROSENBERG.

H. & D. ROSENBERG,

IMPORTERS, JOBBERS AND DEALERS IN

Diamonds, Watches, Jewelry AND Silver Ware,

WATCH TOOLS, MATERIALS, &c.

Sole Agents for Chas. E. Jacot's Watches,

No. 11 STATE STREET,

POWERS' FIRE-PROOF BUILDINGS, }
Sign of Illuminated Clock, } - - Rochester, N. Y.

E. S. ETTENHEIMER & CO.,

Importers, Jobbers and Dealers in

Watches, Diamonds, Jewelry AND Silver Ware,

No. 2 STATE STREET,

At the Old Burr Stand,

Rochester, N. Y.

CLOSED ON SATURDAYS UNTIL EVENING.

BAUSCH & DRANSFIELD,

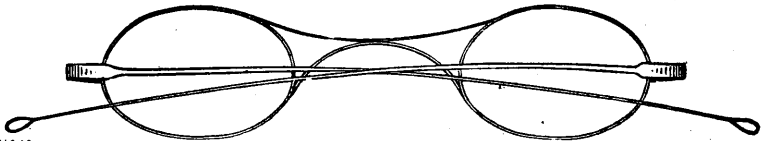

Mathematical, Philosophical, Telegraph

AND ALL KINDS OF

OPTICAL INSTRUMENTS,

In Finest Qualities and at Catalogue Prices,

No. 20 ARCADE, opp. Post Office, - - ROCHESTER, N. Y.

M. WACKERMAN,

MANUFACTURER OF

Gents' Wigs and Toupees,

ALSO,

LADIES' AND THEATRICAL WORK,

90 STATE STREET, Up Stairs, - - ROCHESTER, N. Y.

All Orders Promptly Attended to.

CROSMAN
BRO'S
FLORISTS
 AND
SEEDSMEN,

Monroe Avenue,

Catalogues furnished free on application.
 Street Cars within seven minutes walk of our office.

Rochester, N. Y.

JOHN HAY,

DEALER IN

Fine Watches and Jewelry,

SILVER AND PLATED WARE,

All of which we are now selling at very low prices.

FINE CHRONOMETERS—KEY AND STEM WINDING.

Watches and Jewelry Repaired.

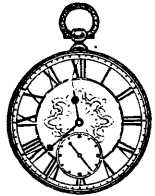

53 West Main Street, opposite Powers' Block,

ROCHESTER, N. Y.

SUNDERLIN & M'ALLASTER,

IMPORTERS,

WHOLESALE AND RETAIL DEALERS IN

FINE WATCHES,

DIAMONDS,

Jewelry, Silver Ware, French Clocks and Bronzes,

HOTEL GOODS, PLATED WARE, &c.,

18 State Street, Cor. Exchange Place, **Rochester, N. Y.**

11
11
11
11
11



88 & 89 ARCADE.

PETER RICE,
Manufacturer of

SHOW CASES,
Plain and Ornamental,
EITHER WOOD OR METAL.

Show Cases of any Description,
MADE TO ORDER,
At Prices unknown in the City.

Wood Cases - \$2.50 Per Foot. | Metal Cases - \$4.75 Per foot.
No. 89 South St. Paul Street, ROCHESTER, N. Y.



MERRIAM & COMPANY,

WHOLESALE AND RETAIL

Booksellers & Stationers,

40 WEST MAIN STREET,

HENRY H. MERRIAM,
CHARLES E. MORRIS,
HOMER MERRIAM (Springfield, Mass.) }

Rochester, N. Y.

1846.

1876.

ERASTUS DARROW,

WHOLESALE AND RETAIL

BOOKSELLER,

STATIONER AND PUBLISHER,



Office of Moore's Rural New Yorker and Agricultural Books,



Osburn House Block, 67 E. Main Street,

ROCHESTER, N. Y.

Send for Darrow's List of Publications.

ALWAYS AT THE LOWEST PRICES.

W. A. WILLIAMSON.

HORACE A. HIGBIE.

WILLIAMSON & HIGBIE,

BOOKSELLERS, STATIONERS

—AND—

LAW BLANK PUBLISHERS.

Circulating Library. General News Depot.

ALL KINDS OF LAWYERS' GOODS, AT WHOLESALE OR RETAIL,

62 West Main Street, Powers' Buildings,

ORDERS FOR JOB PRINTING RECEIVED.

ROCHESTER, N. Y.

THOMAS GIVENS,

Chromo, Map and Show Card

MOUNTING ESTABLISHMENT,

114 FRONT STREET,

ROCHESTER, N. Y.

SPECIMENS FURNISHED FREE OF CHARGE.

JOHN C. MOORE,
BOOK BINDER,

—AND—

BLANK BOOK MANUFACTURER,

No. 27 Smith's Arcade,

West Main, cor. Exchange Street, entrance between 61 and 63,

ROCHESTER, N. Y.

With TWO RULING MACHINES, we are prepared to furnish work with dispatch and neatness.

STEELE & AVERY,
BOOKSELLERS AND STATIONERS,

and Manufacturers of

CROQUET,

SOLE AGENTS FOR THE CELEBRATED

PHILADELPHIA LAWN MOWER.

Nos. 44 and 46 State Street, - ROCHESTER, N. Y.

THE MOST COMPLETE ESTABLISHMENT IN THE STATE.

O. D. GROSVENOR,

No. 75 State Street, ROCHESTER, N. Y.

WHOLESALE AND RETAIL DEALER IN

Religious and Sunday School Books,

AND AGENT OF THE

AMERICAN BIBLE AND TRACT SOCIETIES,

And Office of the Illustrated Christian Weekly.

SUNDAY SCHOOL PAPERS ALWAYS ON HAND.

SIGMUND SAX,

Successor to F. W. KUHNERT,

BOOK BINDER,

CASE MAKER,

Also make a specialty of

Chromo Mounting.

MAPS MOUNTED AND VARNISHED IN THE BEST MANNER,

No. 51 Front St., - ROCHESTER, N. Y.

WILLIAM CREED.

FRED. W. AVERY.

CREED & AVERY,

29 WEST MAIN STREET,

BOOK BINDERS,

PAPER RULERS

AND

Blank Book Makers.

Over J. H. Hill's Hardware Store.

Pamphlet Work a Specialty.

GEO. D. RAMSDELL

PHOTO ENGRAVING

DESIGNING

WOOD ENGRAVING

142 POWERS' B. ROCH. N.Y.

RELIEF PLATES for Newspaper, Book and Catalogue Illustrations Engraved, in hard Type Metal, by a new Photographic Process. Prints, Pen Drawings, Pencil Sketches and Photographs available.

These Plates are an excellent substitute for Wood-cuts. Their average cost is much less, and they are preferable in other important respects. They can be printed perfectly on any ordinary press.

Also, WOOD AND SEAL ENGRAVING.

For further information call on or address as above.

MRS. M. B. LOGAN,

Manufacturer of

LADIES' FASHIONABLE

HAIR WORK

In all its branches.

Particular Attention paid to Parties residing out of the City.

Preserver of

NATURAL FLOWERS.

FLORAL WREATHS, MASONIC EMBLEMS, CROSSES, ETC.,

Preserved in their *Natural Beauty* by a new process.

No. 52½ NORTH ST. PAUL STREET,

On the Line of the North St. Paul Street Horse Cars,

ROCHESTER, N. Y.

ROCHESTER BEOBACHTER

(OBSERVER.)

23 West Main Street.

ADOLPH NOLTE, Proprietor.

Daily Beobachter, \$7.80 Per Year. Weekly Beobachter, \$2.50 Per Year.

**BOOK, JOB AND ORNAMENTAL PRINTING,
IN GERMAN AND ENGLISH.**

ELECTROTYPING
IN ALL ITS BRANCHES.
FOUNDRY
OVER COR. EXCHANGE PLACE & FRONT ST.
ROCHESTER, N.Y.
JAMES LENNOX PROP.
ESTABLISHED 1857.

ROCHESTER PAPER COMPANY,

MANUFACTURERS OF

Printing and Book Paper.

LOWER FALLS.

Take Lake Avenue Street Cars to Champion Street.

Rochester, N. Y.

A. M. HASTINGS, President.

JAMES CALLAHAN,

The Only Licensed

CITY BILL POSTER,

Controls all Dead Walls and Bill Boards in City.

OFFICE:—No. 8 Corinthian Hall Building,

(Box in Arcade Hall),

ROCHESTER, N. Y.

RESIDENCE 51 Troup Street, Corner Ford.

A. A. LE CLEAR,
PHOTOGRAPHER

80 and 82 STATE STREET,

Great care taken with Children and Copies. ROCHESTER, N. Y.

GODFREY & CO.,
Sunbeam Picture Gallery,

Over 81 East Main Street, Rochester, N. Y.

ENTRANCE,

First Stairs East of the New York Store.

BENJ. P. CROSSMAN,
PHOTOGRAPHER,

No. 120 State Street,

ROCHESTER, N. Y.

A. E. DUMBLE & CO.,
PHOTOGRAPHERS,

Nos. 44 and 46 State Street,

ROCHESTER, N. Y.

P. B. BRADLEY,

MANUFACTURER OF

PICTURE FRAMES AND MOULDINGS,

And the Best Carved Rustic Frames in Market.

DEALER IN PHOTOGRAPHIC MATERIALS.

French Glass, Albums, Stereoscopes and Views, Velvet Passepartouts, Velvet, Walnut and Gold Inlaid Frames, Oval and Square, at Wholesale and Retail.

118 FRONT STREET, - - ROCHESTER, N. Y.

Near New York Central R. R. Depot.

H. P. RUNDEL,

Rochester Art Gallery,

57 WEST MAIN STREET,

Wholesale and Retail Dealer in

ENGRAVINGS,

Chromos, Paintings, Lithographs, Stereoscopes and Views,

ALSO ALL KINDS OF

PICTURE FRAMES, BRACKETS, SHELLS, &c.

D. M. DEWEY,

ART GALLERY,

Dealer in

Works of Art, Engravings, Chromos, Paintings, Sculptures, &c.

• WEDDING AND BIRTHDAY GIFTS.

Inventor and Manufacturer of

COLORED FRUIT PLATES,

And Publisher of Horticultural Books and Nurserymen's Requisites.

(AT THE OLD STAND),

No. 8 and 10 ARCADE, - - ROCHESTER, N. Y.

SANDERSON'S

Fine Art Gallery,

PICTURE FRAME AND BRACKET FACTORY,

Wholesale and Retail.

24 Exchange Street, - - near Clinton Hotel,

ROCHESTER, N. Y.

BOSTWICK & HEINDL,

Plain and Ornamental

JOB PRINTERS,

No. 2 EAST MAIN STREET,

Directly Opposite Front Street,

ROCHESTER, N. Y.

JOHN W. MARTIN & BRO.,

DEALERS IN

Pianos, Organs and Melodeons,

SOLE AGENTS OF

Chickering and Sons'

PIANOS,

For Western New York.

*Have stood the test over
50 years.*

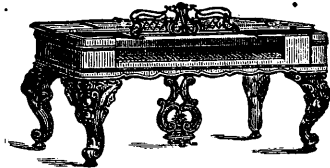

Instruments Rented

—AND—

RENT APPLIED

If purchased, or sold on
monthly payments.

59 STATE STREET.

ROCHESTER, N. Y.

FIFTY - FOURTH REGIMENT BAND.

MUSIC FURNISHED FOR

*Balls, Concerts,
PICNICS, PARADES, &c.*

Band Numbers 30 Pieces, Brass and Reed.
STRING BAND

For BALLS, PARTIES, &c. Any number required
furnished. For terms or other information, address

Jacob Sauer, Leader, Aqueduct St., or A. W. Brigham, Sec'y & Treas., 36 East Main.

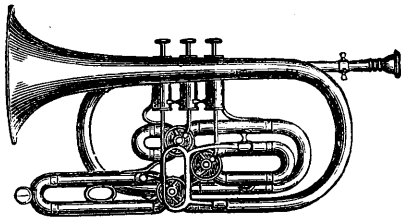

JAS. W. GILLIS,

MANUFACTURER OF

PICTURE FRAMES, LOOKING GLASSES,

And Black Walnut Brackets,

NO. 8 ALLEN STREET, - ROCHESTER, N. Y.

WALNUT FRAMES A SPECIALTY.

GIBBONS & STONE,
Manufacturers of
PIANO FORTES,

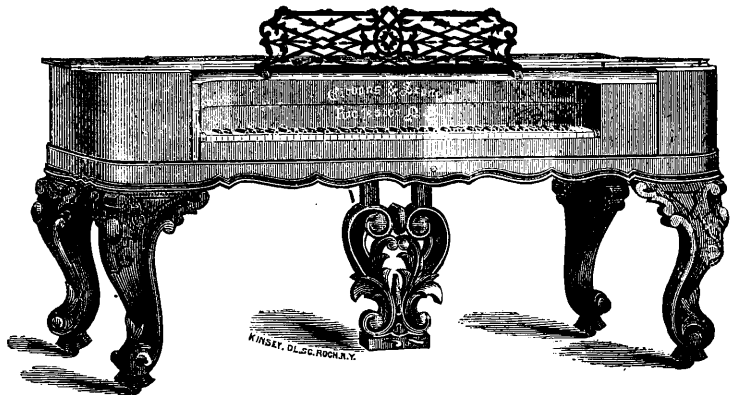

AND DEALERS IN

Cabinet Organs, Sheet Music and General Musical Merchandise.

WAREROOMS, No. 86 STATE STREET,

Manufactory, Nos. 4 and 6 Hill Street, - - ROCHESTER, N. Y.

Second-hand Piano Fortes for Sale or to Rent.

EAST SIDE MUSIC STORE,
109 East Main Street.

J. CRAIGHEAD

Has the Best Stock and Lowest Prices for Everything in the
shape of Music.

PIANOS AND ORGANS

For Sale and to Rent on Installments, very low.

Music and Musical Instruments of all kinds,
and the LOWEST PRICES in the City.

JAMES LOCKHART,

Manufacturer and Jobber of

ALL KINDS OF PICTURE FRAMES,

SQUARE FRAMES A SPECIALTY.

OFFICE AND FACTORY:

Over 121 State Street, - ROCHESTER, N. Y.

Strictest Attention paid to Orders by Mail.

GENESEE FALLS NURSERIES.

H. B. HOOKER & CO.

Office and Grounds, 255 North St. Paul Street.

One and one-half miles from the Court House.

North St. Paul Street Omnibus, from the Osburn House, passes these Grounds hourly.

ROCHESTER, N. Y.

WILLIAM KING & SON, FLOWER GARDEN,

123 Mt. Hope Avenue,

Cor. Sanford Street, - - - ROCHESTER, N. Y.

A CHOICE COLLECTION OF

ORNAMENTAL SHRUBS, VINES, ROSES, HERBACEOUS PLANTS, BULBS, DAHLIAS,

Green-house and Bedding Plants, Hanging Baskets, Vases, &c.

 CUT FLOWERS and FLORAL DESIGNS furnished at short notice.

 Take Mt. Hope Street Cars from West Main Street; stop at first Greenhouse, near Clarissa Street Bridge.

J. DE SAINT-ANGE,

GENERAL AGENT FOR THE

FRENCH NURSERIES,

AND SEED GROWERS.

We can supply direct from France any choice variety of Ornamental or Fruit Trees,
Vegetable or Flower Seeds.

THE ONLY FRENCH AGENCY IN THE UNITED STATES,

Representing the largest and most renowned houses of Europe.

All orders may be addressed direct to me, POST OFFICE BOX 207, or at residence,

No. 67 FULTON AVENUE, ROCHESTER, N. Y.

CHASE BROTHERS, NURSERYMEN AND SEEDSMEN,

No. 1 EAST PARK,

Near 86 East Avenue,

ROCHESTER, - - - NEW YORK.

East Avenue Omnibus passes Office half-hourly.

JOHN CHARLTON,
FLOREST,

UNIVERSITY AVENUE, - - - EAST ROCHESTER.

CUT FLOWERS AND FLORAL DESIGNS

To Order, at Lowest Possible Rates.

Small Fruit Plants, Flowering Shrubs, Roses, Grape Vines,

GREEN-HOUSE PLANTS, &c., &c.

DEALERS SUPPLIED.

H. & J. K. BECKWITH,

A CHOICE ASSORTMENT OF

STANDARD PEAR TREES,

For Fall of 1876 and Spring of 1877.

STANDARD PEARS A SPECIALTY.

Nursery, One-fourth Mile South of Brighton Village,

BETWEEN MONROE AND EAST AVENUES.

JOHN B. KELLER,
FLOREST,

Opposite Mt. Hope Cemetery Gate, - - And South Ave., near Oakland St.,

ROCHESTER, N. Y.

SHRUBS, ROSES, TREES AND PLANTS,

Of all Descriptions.

FINE CUT FLOWERS AND BOUQUETS,

Wreaths, Crosses, Anchors, and all Kinds of Floral Designs.

FIRST-CLASS WORK AT LOWEST PRICES.

J. W. THOMPSON & CO.,

MANUFACTURERS OF

FRUIT AND FLOWER PLATES,

OVER 142 EAST MAIN STREET, (PALMER'S BLOCK,)

ROCHESTER, N. Y.

We are prepared to manufacture FIRST CLASS PLATES for Nurserymen, twenty per cent. less than any other establishment in town, and fully equal, if not superior in quality. What we ask, is an examination of our work, as it is all made under our personal supervision.

ESTABLISHED IN 1834.

ALLING & CORY,

WHOLESALE DEALERS IN

Writing, Wrapping and Printing

PAPERS!

Printers' and Binders'

GOODS AND MACHINERY,

Ruled Papers, Envelopes,

PRINTING INKS, AND ROLLER COMPOSITION,

CARD, STRAW AND JUNK BOARDS,

GLAZED AND FANCY PAPERS.

Special Sizes and Qualities Made to Order.

10 and 12 Exchange Street,

ROCHESTER, N. Y.

WILLIAM ALLING.

DAVID CORY.

FIRST-CLASS PRINTING in BLACK or COLORS.

EVENING

Express Printing Company,

21, 23 & 25 WEST MAIN STREET,
ROCHESTER, N. Y.

JOB PRINTING,

Designing and Wood Engraving

OF ALL DESCRIPTIONS,

SHOW PRINTING, Etc.

Neatly Executed in the most Superb and Expeditious Manner.

BOOKS, PAMPHLETS, CATALOGUES, CIRCULARS,
CARDS, WAY-BILLS, WEDDING AND BALL
INVITATIONS, LABELS, PROGRAMMES,
DODGERS, POSTERS, DRIVING PARK
BILLS, SIGN CARDS, ETC., ETC.

A complete stock of Cuts of all sizes, representing every department of mercantile and manufacturing enterprise, which are at the service of our patrons.

—OUR—

Designing and Engraving

DEPARTMENTS

Are fully equipped for furnishing Designs and Engraving of every description of work, at prices that defy competition.



EVENING EXPRESS,

(PUBLISHED BY)

THE EVENING EXPRESS PRINTING COMPANY,

EVERY EVENING—SUNDAYS EXCEPTED.

Office—21, 23, 25 West Main Street, Rochester, N. Y.

TERMS OF SUBSCRIPTION:

DAILY EVENING EXPRESS, PER ANNUM,	-	-	\$9 00
TRI-WEEKLY EXPRESS, PER ANNUM,	.	-	4 00
WEEKLY EXPRESS, PER ANNUM,	-	-	1.50

The best Advertising Mediums in Western New York.

THE EVENING EXPRESS is the only independent, out-spoken Paper in Rochester. It belongs to no "ring." It is the official paper of the city, and has the largest circulation of any Daily Paper published outside of New York city. The Weekly Edition alone is larger than that of any other two papers published in Rochester.

STATIONERY and WRAPPING PAPERS.

GEO. L. STRATTON & CO.,

DEALERS IN

Staple and Fancy

STATIONERY,

BLANK BOOKS

—AND—

WRAPPING PAPERS

Of Every Description.

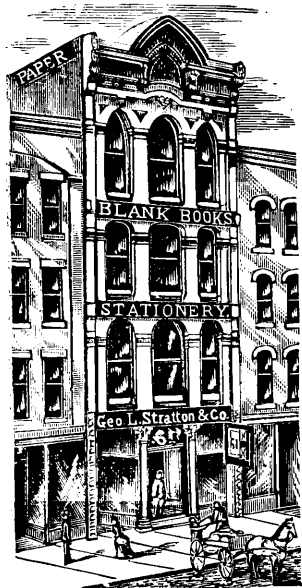

No. 61 State Street,
ROCHESTER, N. Y.

Paper Stock Warehouse,

Nos. 10, 12, 14 and 16 South Aqueduct Street,

REAR OF F. TULLY'S STOVE STORE.

N. B.--The Highest Cash Price paid for RAGS, OLD ROPE, OLD BOOKS, &c., &c.

UNION AND ADVERTISER COMPANY

(Late CURTIS, MOREY & CO.)

PUBLISHERS OF

Daily Union and Advertiser and Weekly Republican.

RATES OF ADVERTISING.

For square of 10 lines or less.

1 day, \$ 75	3 weeks, \$ 5 00	7 months, \$28 00
2 " 1 25	1 month, 6 00	8 " 31 00
3 " 1 75	2 " 10 00	9 " 34 00
4 " 2 25	3 " 14 00	10 " 36 00
5 " 2 75	4 " 18 00	11 " 38 00
1 week, 3 00	5 " 22 00	12 " 40 00
2 " 4 00	6 " 25 00	

MARRIAGES and DEATHS, 50 Cents.

Above rates are for advertisements without change. Advertisements with changes require special contract. Special Notices 50 per cent. in addition to above rates. Local Notices 20 cents per line each publication.

NO LOCAL NOTICE LESS THAN ONE DOLLAR.

Daily Paper, per annum,	\$9 00
Semi-Weekly, per annum,	3 00
Weekly, per annum,	1 50

BOOK AND JOB PRINTING

Of every Description, Neatly Executed,

In MODERN STYLE and at the MOST REASONABLE PRICES.

Union Buildings, West Main Street,

Opposite Court House,

ROCHESTER, N. Y.

JOSEPH CURTIS, Pres't.

LORENZO KELLY, Sec'y.

TRUSTEES:

JOSEPH CURTIS,

JOHN E. MOREY,

WM. PURCELL.

GEO. G. COOPER,

LORENZO KELLY.

Democrat and Chronicle,

No. 3 West Main Street,

ROCHESTER, N. Y.

DAILY. SEMI-WEEKLY. WEEKLY.

T H E

BOOK AND JOB DEPARTMENT

Connected with this Establishment is

Complete in Every Detail.



 *All Work Guaranteed at the most Reasonable
Prices and with Dispatch.*

C. W. WOODWARD'S FINE ART DEPOT

126 STATE STREET,

Since 1862 has been the headquarters for Rochester and vicinity for everything new and attractive pertaining to Pictures, and their belongings. Always ahead and leading the market with new patterns of FRAMES, of OUR OWN DESIGN, which find plenty of imitators, we feel warranted in saying ours are the best style of

PICTURE FRAMES

Both the Gold Portrait and Landscape,

—◆—
ALSO, THE CHOICE

VENEERED FRAMES,

FOR ENGRAVINGS.

—◆—
We are publishing

STEREOSCOPIC VIEWS

From 4,000 different Negatives, and have a line unequalled in the number of subjects and in quality of finish.

Of PICTURES, we are able to show every new thing almost as soon as published, in

**Chromos, Engravings,
Photographs, Lithographs,
Panel Flowers and Statuary.**

LOOKING GLASSES, WALNUT BRACKETS, BOOK-SHELVES, EASELS,
MATCH-SAFES, CLOCK-SHELVES, STEREO-VIEW HOLDERS,
FOOT-RESTS, FLOWER-STANDS,

and everything in Walnut Goods.

WHOLESALE AND RETAIL TRADE SUPPLIED.

Prices Reduced to Meet the Times.

GIVE US A CALL.

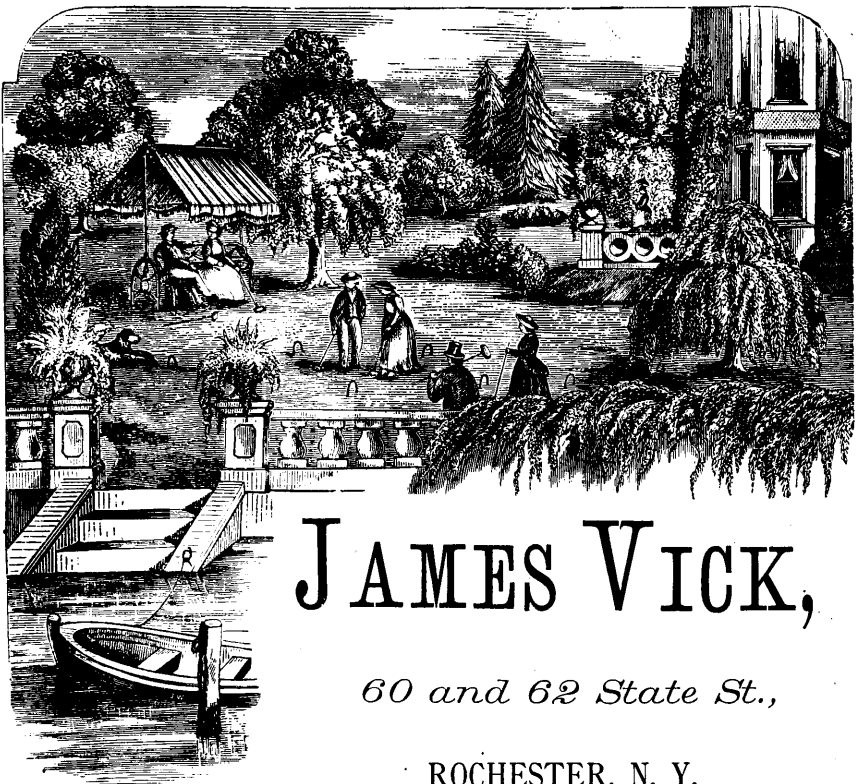

JAMES VICK,

60 and 62 State St.,

ROCHESTER, N. Y.

Flower Seeds,

LAWN TENTS, VASES,

LAWN MOWERS, &c.,

Wholesale and Retail.

BRIGGS & BROTHER,

Importers, Growers and Wholesale Dealers in

GARDEN, FIELD AND FLOWER SEEDS,

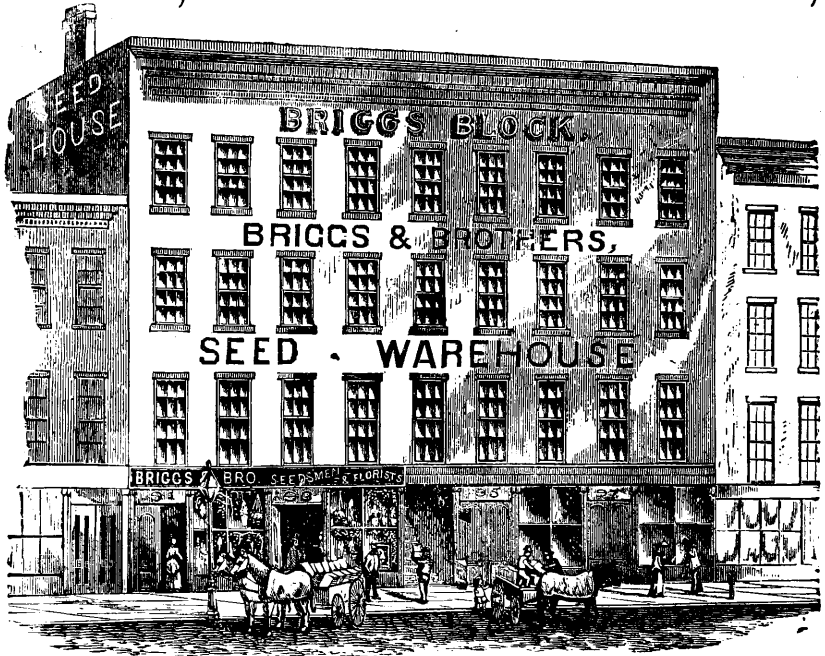

—AND—

FLOWERING BULBS,

91 and 93 State Street, - Rochester, N. Y.

184 & 186 Washington St., Chicago, Ill.

Our very complete Catalogue of Fall Bulbs will be ready for distribution and mailing about the middle of August. It will contain a full and general assortment and description of all Bulbs suitable and desirable for fall planting, and will also contain an assortment of such varieties of Flower and Vegetable Seeds as are adapted for fall sowing. BULB CATALOGUES GRATIS ON APPLICATION.

Our re-arranged and much improved general Flower, Vegetable and Summer-Flowering Bulb Catalogue for 1877, will be ready by 1st December. Read advertisement of same when published.

[ESTABLISHED 1845.]

BRIGGS & BRO., Rochester, N. Y.



184 and 186 Washington Street, Chicago, Ill.

NEW DEPARTMENT.

ELECTROTYPING!

The undersigned have added to their other business ELECTROTYPING.

Work will be done promptly and in first-class style.

CALL AT SEED STORE,

91 & 93 State Street, - Rochester, N. Y.

BRIGGS & BROTHER.

ROCHESTER BOX MANUFACTORY.



J. B. STEVENS & SON,

MANUFACTURERS OF ALL KINDS OF

WOOD PACKING BOXES,

—ALSO,—

GRAPE, PEACH and OTHER FRUIT

BOXES AND CRATES,

*FANCY BLACK WALNUT BOXES, FOR PERFUMERS,
SEEDSMEN AND OTHERS.*



We have lately added to our already very complete outfit of Wood-working Machinery a newly invented

PATENT DOVE-TAILING MACHINE,

which adds very greatly to the rapidity of making boxes, and to their strength, durability, and neatness of finish.

FACTORY, FOOT OF CENTRE STREET,

ROCHESTER, N. Y.

W. W. PARSELLS,
MERCHANT TAILOR,

(Successor to W. R. STACE,)

No. 12 WEST MAIN STREET,
ROCHESTER, N. Y.

W. D. MCGUIRE & CO.,
MERCHANT TAILORS

—AND—

Importers of Fine Woolens for Men's Wear,
Elwood Block, cor. W. Main and State Streets, Up Stairs,
ROCHESTER, N. Y.

WM. D. MCGUIRE.

R. E. WINTERSTEIN.

JAMES F. MCCAULEY,
MERCHANT TAILOR,

—AND—

Importer of Fine Woolens,
35 State Street, - - Rochester, N. Y.

JOHN H. MILLER,
MERCHANT TAILOR

No. 6 Exchange Place,

Corinthian Hall Building, - - - ROCHESTER, N. Y.

**BORNEMAN BRO'S,
MERCHANT TAILORS,**

No. 8 NORTH CLINTON STREET,

Phoenix Club Building,

ROCHESTER, N. Y.

FULL LINE OF ENGLISH AND FRENCH WOOLEN GOODS.

**GEORGE N. STORMS,
MERCHANT TAILOR,**

—AND—

FINE CLOTHIER,

No. 10 West Main Street, - Rochester, N. Y.

**JAMES KENNEDY,
MERCHANT TAILOR,**

No. 8 Mumford Street,

ROCHESTER, N. Y.

O. W. MOORE.

A. G. MCNERNEY.

**MOORE & MCNERNEY,
MERCHANT TAILORS,**

No. 60 East Main Street,

Opposite Osburn House.

ROCHESTER, N. Y.

WILLIAM COX,
MERCHANT TAILOR,

And DIRECT IMPORTER of

FINE WOOLENS,

17 and 19 Front Street, - Rochester, N. Y.

WHEELER & WILSON,

LATEST IMPROVED

Sewing Machines,

20 Main Street Bridge,

ROCHESTER, N. Y.

S. W. DIBBLE & DUTTON, Agents.

AGENTS FOR

MADAME DEMOREST'S CELEBRATED DRESS PATTERNS.



HATTER
AND
FURRIER,

58 State Street,
ROCHESTER, N. Y.

Sole Agent for the Celebrated

"DUNLAP" SILK HAT.

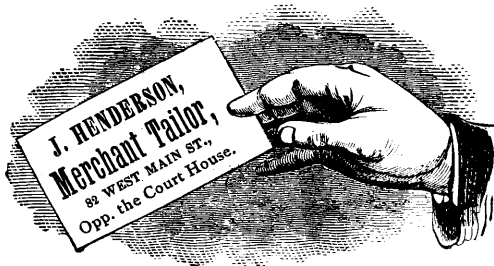

J. MORTON & CO.,
IMPORTERS AND MERCHANT TAILORS,

AND WHOLESALE AND RETAIL DEALERS IN

Men's and Boys' Ready-Made Clothing,

11 Main Street Bridge, - - Rochester, N. Y.
(NEW NUMBER 21.)

McRODEN & CO.,
Custom and Ready-Made
CLOTHING HOUSE,

A SPLENDID ASSORTMENT OF

CLOTHS, CASSIMERES AND VESTINGS,

12 Main Street Bridge, - Rochester, N. Y.

JACOB NUNNOLD,
MERCHANT TAILOR,

AND DEALER IN

READY-MADE CLOTHING,

CLOTHS, CASSIMERES, VESTINGS, TRIMMINGS, ETC.,

No. 1 Front Street, Rochester, N. Y.

L. A. PRATT, BOOTS, SHOES,

· AND RUBBERS,

54 State Street,

ROCHESTER, N. Y.

 *The Only Store in the City
that sells E. C. BURT'S New
York made Boots and Shoes.*

The BEST made in the U. S.

L. P. BECK & BRO., BOOT, SHOE AND RUBBER EMPORIUM,

No. 87 East Main Street, - Rochester, N. Y.

CUSTOM WORK MADE TO ORDER.

L. P. BECK.

E. B. BECK.

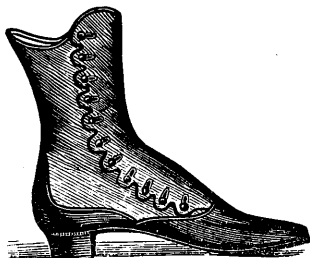

E. BROWNELL, Foreman.

E. D. WEBSTER, Wholesale and Retail Dealer in Boots, Shoes and Rubbers, 117 East Main Street,

Opp. Whitcomb House. ROCHESTER, N. Y.

CUSTOM WORK MADE TO ORDER ON SHORT NOTICE.

JOHN ODENBACH, HATTER AND FURRIER,

DEALER IN

LADIES' FINE FURS AND ROBES,

No. 49 State Street, - - Rochester, N. Y.

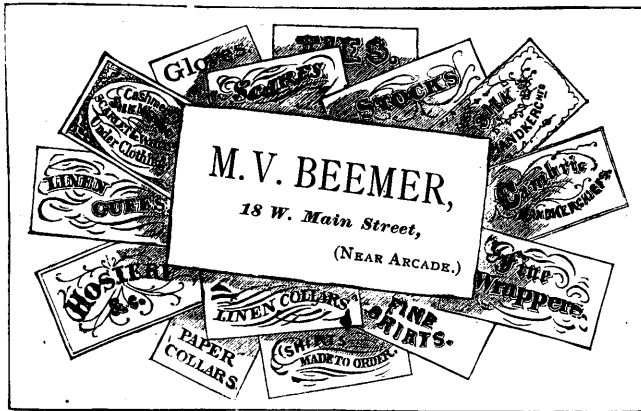

Importer of fine Neck-Wear, Under-Wear and Hosiery.

KENYON & HUNT,
IMPORTERS, MANUFACTURERS AND JOBBERS OF
HATS, CAPS, FURS,
100 and 102 STATE STREET, Cor. Mumford,
ROCHESTER, N. Y.

Ladies' Fine Furs a Specialty.

R. S. KENYON.

D. T. HUNT.

ODENBACH & SHALE,
PRACTICAL
HATTERS AND FURRIERS,

No. 7 State Street, Powers' Block,

JACOB ODENBACH, }
JOSEPH G. SHALE, }

ROCHESTER, N. Y.

LADIES' FINE FURS.

JOHN W. TAYLOR,
PHOTOGRAPHER,

Over 83 and 85 Main Street, - Crystal Palace Block,

ROCHESTER, N. Y.

Pictures in Water Colors and India Ink, and Enlarged to all Sizes.

D. H. WESTBURY,

(Successor to L. S. CHAPIN),

MANUFACTURER OF

MEN'S, BOYS' AND YOUTHS'

BOOTS AND SHOES,

—ALSO,—

WOMEN'S AND MISSES' CALF PEGGED SHOES,

Over 79 Water Street, - ROCHESTER, N. Y.

RICHARD BUCKLEY,
Silk and Cassimere Hats

MADE TO ORDER AND REMODELED,

Over 60 East Main, cor. South St. Paul Street,

(OPPOSITE OSBURN HOUSE,)

ROCHESTER, N. Y.

HATS BLOCKED WHILE WAITING.

ADAM SCHMITT,

(Late of the 140th N. Y. Regiment,)

MANUFACTURER AND DEALER IN

BOOTS AND SHOES,

162 State, corner Centre Streets, Rochester, N. Y.

Custom Work made to Order. Repairing neatly done. The attention of young men is directed to our FINE BOOTS.

HENRY GARSON.

MOSES H. GARSON.

H. GARSON & SON,

Manufacturers, Wholesale and Retail Dealers in

MEN'S AND BOYS' CLOTHING,

IMPORTERS OF

Cloths and Cassimeres,

75 East Main Street,
Next Door to Sibley's,

- - - ROCHESTER, N. Y.

BOONE,

"THE" TAILOR,

Late with G. N. STORMS,

NOW LOCATED AT

20 WEST MAIN STREET,

Over Laine & Paine's.

T. R. BOONE.

M. SHANNON,

MERCHANT TAILOR,

No. 8 East Main Street,

Room 3.

Rochester, N. Y.

E. STEINFELD,

POPULAR ONE PRICE

CLOTHIER,

—AND—

MERCHANT TAILOR,

Men's Boys', Youths' and Children's Clothing of Superior
Make and Quality.

No. 8 Main Street Bridge, - Rochester, N. Y.
(NEW NUMBER 15.)

ZELLWEGER BRO'S, .

Over No. 117 West Main Street, . . . Odd Fellows' Temple,
ROCHESTER, N. Y.

Stamping and Embroidery,

SILKS, BRAIDS, COTTONS, CHENILLE, ETC.,
CONSTANTLY ON HAND.

Stamping done on all kind of Goods with Neatness and Dispatch.

JOHN KUHLMAN,

COSTUMES

—LET FOR—

Masquerade Balls, Parties, &c.,

A large variety of "Square Outs," for Centennial Receptions and Old Folks' Concerts.

Residence, 3 Oregon Street, near Atwater Street,

Orders may be left at 92 Arcade.

ROCHESTER, N. Y.

ROCHESTER KNITTING WORKS.

LOWENTHAL & ETTENHEIMER,

Manufacturers,

No. 10 Mumford Street, . . . Rochester, N. Y.

LADIES' CROCHET AND KNIT JACKETS,

Machine-Knit Mittens, Socks, Leggings, Fancy Hosiery, &c.

DEALERS IN WOOL YARNS.

Economical Job Printing Office.

KEELER & WINFIELD,

STEAM

JOB PRINTERS,

Bill Heads, Letter Heads, Envelopes,

Corner Mill Street and Exchange Place, . . . ROCHESTER, N. Y.

John D. A. Mensing.

Anton Rahn.

Frank A. Stecher.

COPIES.
 Certificates of Stock &
 DIPLOMAS
 Bill & Sales Receipts
 CHECKS.
 Orders of Machinery, Buildings, etc.
 furnished on the Spot.

LITHOGRAPHIC & CHROMA CO.
 OF ROCHESTER, N.Y.
 MENSING, RAHN & STECHER.

Engravers
 AND
Printers.

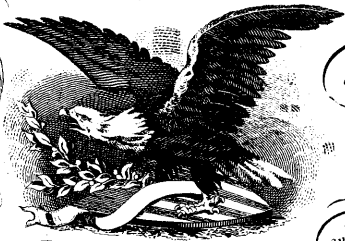

CHROMOS
 SHOW CARDS
 Labels.

Lithographic

PORTRAITS
 MUSIC TITLES
 Maps.

STEAM PRESS

Business Cards
 Notes

PRINTING

Circulars
 Drafts

No. 7 Market Street.

Rochester, N.Y.

Corner Mill Street.

J. FAHY & CO.,

Importers and Wholesale and Retail Dealers in

**RIBBONS, SILK, MILLINERY,
Fancy Dry Goods,****NOTIONS, ZEPHYR WORSTEDS, ETC.,****Retail, 64 STATE STREET,**

WHOLESALE, { Nos. 2 and 4 MARKET STREET,
27, 29 and 31 MILL STREET, cor. MARKET, Rochester, N. Y.
NEW YORK, 522 BROADWAY.

A. MOCK,

WHOLESALE AND RETAIL

MILLINERY,

AND FANCY GOODS,

No. 52 STATE STREET, - Rochester, N. Y.

SHATZ, LOWENTHAL & LEITER,

Successors to S. ROSENBLATT & Co.,

Fancy & Millinery Goods,

ZEPHYR WORSTEDS, HOSIERY and SMALL WARES,

40 & 42 State Street,
11 & 13 Mill Street,*Rochester, N. Y.***BURKE, FITZ SIMONS, HONE & CO.,**

IMPORTERS, JOBBERS AND RETAILERS OF

DRY GOODS AND FANCY GOODS,

CLOTHS, CASSIMERES, TAILORS' TRIMMINGS,

Nos. 53 55 and 57 E. Main St., and Nos. 1, 3, 5, 7 and 9 North
St. Paul Street,**ROCHESTER, N. Y.**

HICHBORN & CO.,
NEW
DRY GOODS STORE,

No. 13 Main Street Bridge.

STOCK ALL NEW ! NO OLD GOODS !

Goods purchased at a great sacrifice to the manufacturers and importers,
from the CHOICEST NOVELTY to the MOST STYLISH GOODS.

FINE BLACK SILKS.

J. H. STUART.

REMOVAL.

MRS. J. B. HANNA

Has removed to the more eligible location, 44 STATE STREET (Up Stairs, over
STEELE & AVERY'S BOOK STORE), where she will devote her time
exclusively to

MILLINERY,

and will keep a full assortment of all goods usual in that line of business.

MRS. J. B. HANNA, 44 State Street.

N. B.—Stamping for Braiding and Embroidery in all the newest designs.

THE FAMILY FAVORITE.

BUY THE

“Weed” Sewing Machine.

T. S. MAXWELL, Manager,

18 East Main Street, Rochester, N. Y.

Ocuppaugh's New Building. With J. P. SHAW.

MRS. W. H. COFFIN,

DRESS AND CLOAK MAKER,

Over 22 Main Street Bridge,

No. 2 First Floor.

ROCHESTER, N. Y.

CUTTING AND FITTING A SPECIALTY.

McDOWELL & CO.,

DEALERS IN

LADIES' FURNISHING AND FANCY GOODS,

**Infants' Complete Outfits, Dress Trimmings,
LACES, EMBROIDERIES,**

**Worsted, Corsets, Gloves, Hosiery, Fine Yarns and General Small Wares,
53 STATE STREET, OPP. MARKET STREET,**

Store formerly occupied by the Wheeler & Wilson S. M. Co.

ROCHESTER, N. Y.

H. M. MOSELEY & WIGHTMAN,

LADIES', MISSES' AND CHILDREN'S

Cloaks, Suits, Underwear,

AND

FURNISHING GOODS,

7 Main Street Bridge, Rochester, N. Y.

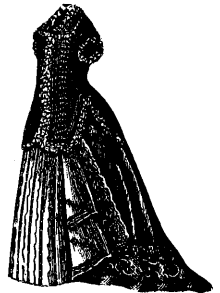

MILLINERY AND FANCY GOODS.

THE LATEST NOVELTIES IN

Hats, Bonnets, Flowers and Ribbons.

ALSO,

**HOSIERY, GLOVES, HOOP SKIRTS, GOLD AND JET JEWELRY,
HAIR GOODS, &c.**

E. A. PENNY,

Successor to PENNY & WARD,

111 East Main Street, - - - ROCHESTER, N. Y.

MRS. J. H. CASEY,

LACE REPAIRER,

POINT APPLIQUE,

And all other kinds of FINE LACES, repaired and done up in the Best Manner.

ALSO, LACE CURTAINS.

19 Kent Street, - - - Rochester, N. Y.

LEWIS STERN,
 (ESTABLISHED 1864),
 HATS, CAPS,
 STRAW GOODS,

At Wholesale Only,

No. 73 Mill Street, - Rochester, N. Y.

Harvest and Palm Leaf Hats a Specialty.

FASHIONS SAVINGS.—By using the “**Domestic**” Paper Fashions, the most stylish and perfect-fitting costumes can be produced, at a large saving in MONEY to those who choose to make, or superintend the making of, their own garments. With the highest talent and the best facilities in all departments, and the best ideas of the most skillful modistes, both at home and abroad, we are enabled to attain results far above the reach of the average dress-maker. Our styles are always the latest and best.

Sold by **MRS. JAMES HENDERSON, 52 State Street.**

THE NEW, LIGHT RUNNING

“**DOMESTIC,**”

Is Simple, Durable, Easily
 Operated and Managed,
 Always Ready for Use,
 and not liable to get
 out of order.

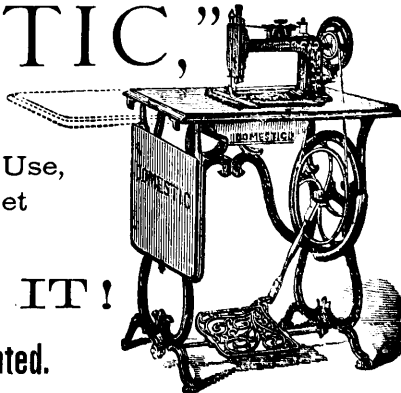

TRY IT, BUY IT!

Every Machine Fully Warranted.

Sold by **Mrs. James Henderson, 52 State Street,**
 ROCHESTER, N. Y.

IMPORTERS.

SIBLEY, LINDSAY & CURR,

Jobbers and Retailers of

DRY GOODS,

Manufacturers of

LADIES' UNDERCLOTHING,

Suits, Garments, &c., &c.

69, 71 and 73 East Main St.,

(MARBLE BLOCK,)

ROCHESTER, N. Y.

SINGER IMPROVED

New Family and Manufacturing

SEWING MACHINES.

These Machines are too well known to need comment.

Silk, Twist, Linen and Cotton Thread, Oil, Needles, Etc.

MACHINE STITCHING AND EMBROIDERY OF ALL KINDS.

GENERAL AGENCY,

43 STATE STREET,

ROCHESTER, N. Y.

JONES & SUGRU, Agents.

—◆—
All-kinds of Sewing Machines Repaired, with Promptness and Dispatch, and at Reasonable Rates.

—◆—
We are also General Depot for

BUTTERICK'S
CELEBRATED FASHION PATTERNS,
FOR LADIES' AND CHILDREN'S DRESS.

GENESEE COFFEE AND SPICE MILLS.

—◆—
 C. T. MOORE,
 TEAS, COFFEES AND SPICES,

14 Front Street, Rochester, N. Y.

Mustard, Baking Powder, Starch, Cream Tartar, Sweet Oil, Castor Oil, &c.

BREWSTER, GORDON & CO.,

Wholesale Grocers

No. 80 EAST MAIN STREET,

Rochester, N. Y.

—◆—
 Goods sold strictly in conformity with New York Prices

J. H. BREWSTER.

D. M. GORDON.

E. FRANK BREWSTER.

CHAS. F. SMITH.

GILMAN H. PERKINS.

HARVEY W. BROWN

SMITH, PERKINS & CO.,

(ESTABLISHED 1826.)

Wholesale Grocers,

Nos. 14, 16 and 18 EXCHANGE ST.,

TEAS A SPECIALTY.

Rochester, N. Y.

H. AUSTIN BREWSTER.

P. V. CRITTENDEN

H. AUSTIN BREWSTER & CO.,

WHOLESALE DEALERS IN

GROCERIES & PROVISIONS

CLOVER AND TIMOTHY SEED,

No. 6 South St. Paul Street,

- - - Rochester, N. Y.

No goods bought or sold by runners, thereby saving a large expense. We buy our goods for cash and at bottom prices, and will sell the new crop of Coffees, Teas, Sugars and all kinds of prime groceries for less than the same quantity and quality can be bought elsewhere in this city or New York.

Established in 1844.

ROCHESTER CITY
STEAM
COFFEE & SPICE MILLS,

B. B. VAN ZANDT,

The Oldest Manufacturer and Dealer in

Genuine Ground Spices

IN WESTERN NEW YORK,

All the latest Improvements in Machinery for
Roasting and Grinding

C O F F E E S .

JOBBER IN

Teas, Spices, Cream Tartar and Mustard.

FLAVORING EXTRACTS.

a specialty.

All Goods Warranted as Represented.

No. 112 State St.,

ROCHESTER, N. Y.

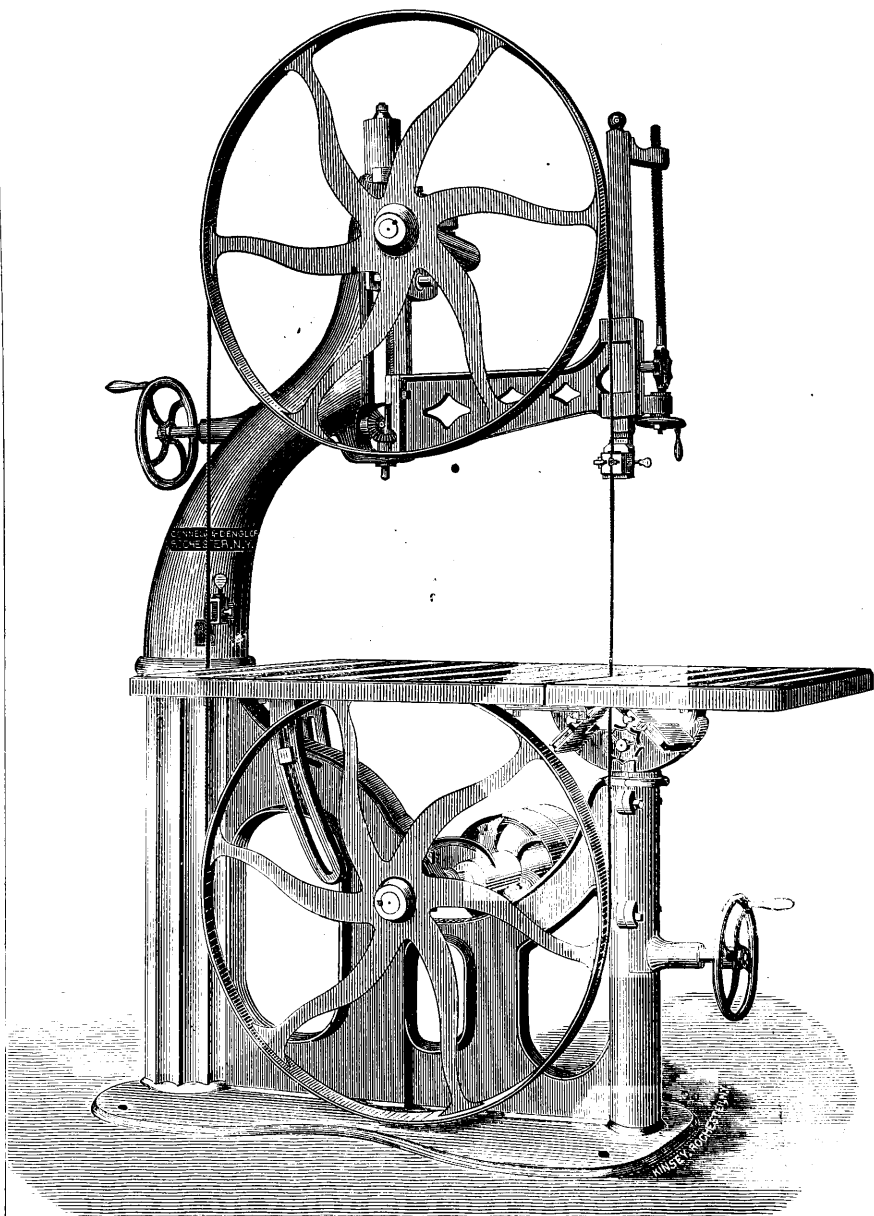

CONNELL & DENGLER,

Manufacturers of Improved

Wood Working Machinery,

*Planers and Matchers, Band Saws, Solid Plate and
Segment Re-Saws, Scroll Saws, &c.,*

Corner Mill and Furnace Streets, - ROCHESTER, N. Y.

ESTABLISHED 1853.

**H. BREWSTER & CO.,
WHOLESALE GROCERS**

AND COMMISSION MERCHANTS,

*Also, Dealers in Provisions, Clover and Timothy Seed. Goods Sold
at New York Jobbing Prices.*

No. 72 East Main Street, - Rochester, N. Y.

HENRY BREWSTER.

STEPHEN REMINGTON.

JAMES M'TAGGART.

J. DEVOS,



PORK PACKER,

Wholesale and Retail Dealer in

Salt, Smoked & Fresh Meat,

EXTRA REFINED LARD, &c.,

No. 44 FRONT STREET,

ROCHESTER, N. Y.

ESTABLISHED 1844.

**GEO. C. BUELL & CO.,
Wholesale Grocers,**

Nos. 36 & 38 Exchange St., Rochester, N. Y.

N. B.—Goods at New York Jobbers' Prices.

R. D. HALL & CO.,

Sole Agent for

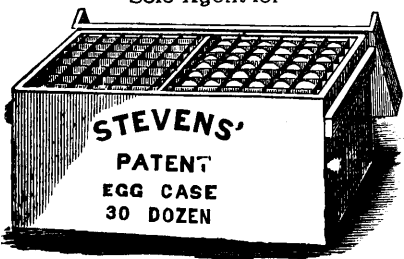

COMMISSION MERCHANTS
DEALERS IN

Foreign and Domestic Fruits,

—AND—
ALL KINDS OF PRODUCE.

Cash for all kinds of Country Produce.

175 & 177 East Main Street,

Sibley Block.

ROCHESTER, N. Y.

MOSELEY & MOTLEY,

Manufacturers and Wholesale and Retail Dealers in

CHOICE GRADES OF

FLOUR,

FLOUR CITY MILLS,

Near Brown Street, - ROCHESTER, N. Y.

J. B. MOSELEY.

GEO. MOTLEY.

D. LOEBS,

WHOLESALE AND RETAIL

FLOUR STORE,

14 and 16 Allen Street, near State Street,

And 105 HUDSON STREET.

The Celebrated and always reliable CANADA HAXALL FLOUR, Choice Family Flour, Corn Meal, Oat Meal, Corn, Oats, Feed, etc., constantly on hand.

Orders Delivered in any part of the City Free of Charge.

CHARLES B. HILL,

(Successor to C. J. HILL & SON,)

MILLER,

SOUTH WATER STREET, - ROCHESTER, N. Y.

The "C. J. HILL" Flour.

GEO. F. MERZ,

Manufacturer, Wholesale and Retail Dealer in

CHOICE GRADES OF

FLOUR, CORN MEAL, FEED,

BUCKWHEAT, RYE and GRAHAM FLOUR, &c.

PEOPLE'S CUSTOM MILL,

Brown's Race, near Factory Street, Rochester, N. Y.

JOHN G. ZWEIGLE,

Manufacturer, and Wholesale and Retail Dealer in

SMOKED SAUSAGES,

BACON, SMOKED BEEF, HAMS, &c.

45 Front Street, - - Rochester, N. Y.

☞ Orders from out of town promptly attended to. ☛

ROCHESTER SOAP WORKS.

McINTOSH, AIKENHEAD & CO.,

MANUFACTURERS OF

Plain and Fancy Soaps,

CANDLES AND TALLOW,

No. 55 Front Street, - Rochester, N. Y.

CASPAR WEHLE,

STEAM SAUSAGE MANUFACTURER,

Front, Corner of Mumford Street.

Sausages Supplied in any quantities, at Wholesale and Retail.

Also, a **FIRST-CLASS SALOON,**

Furnished with Pure Liquors, Wines, Brandies and Cigars, Beer, Cider and other
SUMMER DRINKS.

FRONT STREET, CORNER MUMFORD, ROCHESTER, N. Y.

J. McCLUSKY,

DEALER IN

Fresh, Salt and Smoked Meats

130 West Main Street,

ROCHESTER, N. Y.



☞ All kinds of Game, Poultry and Vegetables in their season.

GEORGE HAWLEY,

(Successor to T. A. CLARK & Co.)

GROCER,

Dealer in

Teas, Coffees, Spices,

And all kinds of

STAPLE and FANCY GROCERIES.

102 West Avenue, cor. King Street, - - Rochester, N. Y.

WAYTE'S MARKET,

104 West Main Street, Rochester, N. Y.

ALL KINDS OF

GAME, POULTRY,

FISH AND VEGETABLES,

IN THEIR SEASON.

D. E. WAYTE, Prop'r.

PEART & BOORMAN,

Dealer in all kinds of

FRESH AND SALT MEATS.

—ALSO,—

FISH,

Oysters & Poultry.



No. 64 West Avenue, - ROCHESTER, N. Y.

W. N. CLARK,

DEALER IN

FINE GROCERIES, FRUITS,

And Grocers' Sundries,

No. 120 West Main St.,

ROCHESTER, N. Y.

ABRAHAM TEALL,

DEALER IN CHOICE

Fresh, Salt and Smoked Meats,

OYSTERS,



Fish, Poultry,

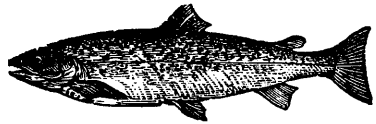

&c, &c.

Vegetables Fresh Every Morning.

79 CALEDONIA AVENUE, ROCHESTER, N. Y.

Rochester City Vinegar Works.

HENRY GOETZMANN,

MANUFACTURER OF

PURE CIDER VINEGAR,

Also Proprietor of the 12th Ward Ice Company,

GOOD PURE ICE SUPPLIED IN ANY QUANTITY.

No. 19 Pinnacle Avenue, - ROCHESTER, N. Y.

All orders will be promptly attended to.

COTTRELL & STEVENSON,

G R O C E R S,

NEW GOODS! NEW FIRM!

THIRD WARD TRADE SOLICITED.

13 Spring Street, cor. Fitzhugh, - ROCHESTER, N. Y.

P A I N E & M I L L S,

G R O C E R S,

AT THE WELL KNOWN STAND,

49 N. Clinton Street, cor. Andrews, - Rochester, N. Y.



DEALER IN

FRESH and SALT
MEATS,

77

EAST AVENUE,
Rochester, - N. Y.

Established 1842.

S. SEAMAN,
GROCCER,

Has returned to the Old Stand,

No. 116 East Main Street, corner South Clinton,
ROCHESTER, N. Y.

Our Goods are all NEW and FRESH.

JOHN STAPE,

Wholesale and Retail Dealer in

FOREIGN AND DOMESTIC

WINES, LIQUORS and CIGARS,

And General Agent for Western New York for the following brands of

KENTUCKY WHISKIES.

*GOLD SPRING,
H. S. BOYD,
CLEAR CREEK,
CRYSTAL SPRING,
W. W. DUNCAN,*

*BLUE GRASS,
MILLER RYE,
NELSON RYE,
LILLIE DALE,*

*GLEN SPRING,
NELSON BOURBON,
LONGFELLOW,
GLEN DALE,
OLD CROW.*

104 East Avenue, - - Rochester, N. Y.

WILLIAM TRAUOGTT,

DEALER IN

GROCERIES, PROVISIONS,

And all kinds of

WINES, LIQUORS, ALE AND BEER,



Also, all Brands of **TOBACCO, CIGARS AND SNUFF.**

No. 35 Scio Street, Haag Block.

GEORGE W. PERCY, GROCER,

40 Allen Street, - Rochester, N. Y.

W. K. DAGGS, MEATS, POULTRY

—AND—
VEGETABLES IN THEIR SEASON.

Removed to Old Stand,

No. 329 State Street, - Rochester, N. Y.

BASTABLE & McDONALD, Cash Grocery House,

42 Allen St., cor. Kent,

ROCHESTER, N. Y.

HENRY BAKER.

GEO. BAKER.

BAKER BROS.,

DEALERS IN

Fresh, Salt & Smoked Meats,

LARD, SAUSAGE, &c.

GAME AND VEGETABLES IN THEIR SEASON,

FRANKFORT MARKET,

No. 258 State Street, - - Rochester, N. Y.

J. C. McKENZIE & CO.,

SHOEING FORGE,

No. 1 Allen Street, corner State,
ROCHESTER, N. Y.

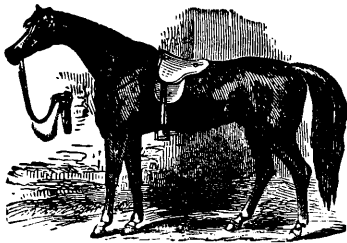

Horses Shod on the most Approved Principles of Veterinary Science.

J. C. McKENZIE, Veterinary Surgeon.

WM. H. DWYER.

A. DANFORD & SON, TURNING AND SAWING.

JOBGING DONE TO ORDER.

DEALERS IN

KINDLING WOOD, WOOD BY THE CORD

Good Wood, Full Measure and Satisfaction Guaranteed. Delivered Free.

Foot N. Water, adjoining Genesee Falls, - Rochester, N. Y.

FACTORY DEPOT,

GAFF, FLEISCHMANN & CO.,

MANUFACTURERS OF

Compressed Yeast.

Original Introducers and Manufacturers in the United States.

FACTORIES:

Greenpoint, L. I., Riverside, Ohio, Cincinnati, Ohio.

156 East Main St. and 4 East Ave., ROCHESTER, N. Y.



HENRY EAST,

Wholesale and Retail
Dealer in

FRESH AND SALT

MEATS,

POULTRY, &c.

Front St., cor. Exchange Place,

ROCHESTER, N. Y.

BRIGHTON NURSERIES,

T. B. YALE & CO., Proprietors.

NURSERIES, ONE AND A HALF MILES EAST OF THE CITY.

EAST AVENUE.

All Passenger Trains each way on the Auburn division of the N. Y. Central Railroad, stop 30 rods North of the Office.

POST OFFICE ADDRESS, ROCHESTER, N. Y.

J. B. NORRIS & SON, NURSERYMEN.

Nursery Stock of all kinds, at Wholesale and Retail, Delivered at Brighton Station, Free of Charge.

NURSERY GROUNDS, ONE MILE EAST OF CITY LINE, EAST AVENUE,

Thirty Rods from Brighton Station.

POST OFFICE ADDRESS, BRIGHTON, N. Y.

FLOUR CITY ICE.

H. T. KING,

OFFICE:

No. 21 Ward Street, Rochester, N. Y.



Orders Received at J. W. McKindley's Hardware Store,
25 WEST MAIN STREET.

 The subscriber is prepared to furnish all who may want good Ice at reasonable rates
Orders will receive Prompt Attention.

HOLY SEPULCHRE MARBLE WORKS.

NICHOLAS STOCK,

MANUFACTURER OF

Monuments, Headstones, Etc.

Yard opposite Holy Sepulchre Cemetery Entrance.

 LAKE AVENUE, NEAR CITY LINE. 

ROCHESTER, N. Y.



JOHN CULHANE,
WHOLESALE CONFECTIONER,
 AND DEALER IN
CIGARS,
 Sicily and Calabria Licorice, Chewing Gum,
 FIRE WORKS, &c.
 No. 144 West Main Street, - - ROCHESTER, N. Y.

JAMES H. MCGUIRE,
 WHOLESALE AND RETAIL
CONFECTIONER,
 No. 60 WEST MAIN STREET,
 Powers' Block, ROCHESTER, N. Y.

WM. H. SOURS,
 (Successor to A. FAVREAU,)
CONFECTIONERY
 Ladies' Ice Cream and Oyster Rooms.
 Fine WINES, BRANDIES and CIGARS.
 101 East Main Street, Rochester, N. Y.
 Parties supplied with ICE CREAM, JELLIES, etc. Orders
 at Wholesale promptly filled.

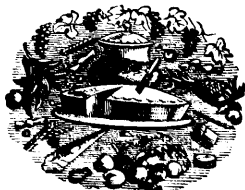

ISAAC TEALL,
CATERER,
 38 North Fitzhugh St., Rochester, N. Y.
Restaurant & Ice Cream Parlors.

I would respectfully announce to the public and my friends, that I have refitted my Parlors equal to any in Western New York, and I have also added to my facilities pertaining to Restauration, so that it will not interfere with my large Party Business. I will cook Warm Meals to order at all hours. A Specialty of FRENCH COFFEE, TEA and CHOCOLATE. Open Evenings for the accommodation of guests returning from Entertainments.
 Yours, respectfully,
ISAAC TEALL.

**PARTIES and WEDDINGS Supplied. ICE CREAM at Wholesale, for
 Hotels, Restaurants, &c., at Cheap Rates.**

J. V. N. SCHERMERHORN,
 DEALER IN
GROCERIES, PROVISIONS,



Fine Teas, Canned Fruits,
 Oysters, Sardines, &c.
 All kinds of *Fruits* in their Season.
FLOUR, FEED, &c.
 Country Produce Bought and
 Sold.
64 NORTH AVE.,
 Cor. University Ave.,
 ROCHESTER, N. Y.

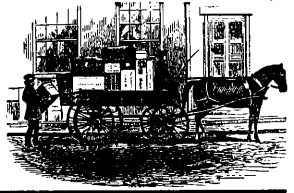

JOSIAH NEWMAN,

(Successor to SCHERMERHORN & Co.),

RECTIFIER,

And Wholesale Dealer in

FOREIGN AND DOMESTIC LIQUORS,

Also, Proprietor and Manufacturer of

Dr. Mavor's Stomach Bitters,

112 Front Street, - ROCHESTER, N. Y.

JOSEPH SAYER,

Importer and Wholesale Dealer in

WINES, BRANDIES, GIN,

OLD BOURBON and MONONGAHELA WHISKY.

Manufacturer of

Double Rectified Whisky and Spirits and Copper Distilled Rye Whisky.

132 West Main St., (Near Corner Sophia St.) **ROCHESTER, N. Y.**

E. B. PARSONS,

MALTSTER,

MALTHOUSE, Cor. Brown and Warehouse Streets,

(Opposite Whitney's Elevator.)

Office, 3 Smith Block, - - **ROCHESTER, N. Y.**

FRED. GOETZMANN, Rectifier and Distiller,

WHOLESALE DEALER IN

IMPORTED WINES AND LIQUORS,

No. 9 Atwater Street,

Near Falls Field.

ROCHESTER, N. Y.

O'NEIL & DEMPSEY,

(Successors to E. J. O'NEIL),

IMPORTERS AND WHOLESALE DEALERS IN

Foreign & Domestic Liquors,

RECTIFIERS OF CIDER.

Rectified Cider and Pure Cider Vinegar.

No. 342 STATE STREET,

E. J. O'NEIL,
JOHN DEMPSEY. }

ROCHESTER, N. Y.

Incorporated 1874.

Capital, \$100,000.

ROCHESTER BREWING CO.,

Manufacturers of Celebrated

STOCK LAGER,

UNSURPASSED BY ANY IN THE MARKET.

Brewery, Cliff Street, near Lake Avenue.

GUSTAVE MANNEL, Prest. Wm. N. OOTOUT, Treas. FRANK A. RUST, Sec'y. FRED. HODECKER, Supt

TRY OUR GOODS.

The Best and Most Extensively Recommended

Wines and Liquors,

Sold at the LOWEST Market Figures.

Respectfully, &c., **GUSTAVE ROSENTHAL,**

107 North, near Atwater Street, Rochester, N. Y.

EMIL REISKY.

HENRY SPIES.

REISKY & SPIES,
LAGER BIER BREWERS,

No. 111 North St. Paul Street, Rochester, N. Y.

—ALSO,—

A FIRST-CLASS SALOON AND BOWLING ALLEY.

KLEIN & HOFHEINZ,
BOTTLERS
of all kinds of

Ale, Porter AND Lager,

FOR HOTEL AND FAMILY USE.

Depot: No. 6 Exchange Place.

*Agents for the Lenk Wine Company's }
Lake Erie Islands Wines.*

Rochester, N. Y.

JAMES O. HOWARD,

IMPORTER AND WHOLESALE DEALER IN

Foreign & Domestic Wines,

LIQUORS AND CIGARS,

No. 114 State Street, - - - Rochester, N. Y.

Agent for Hope Gin and Gibson's XXXX Whisky.

FRED. J. MILLER,
Bottled Lager, Ale, Porter

—AND—

CHAMPAGNE CIDER,

Basement, Cor. North and Main Streets, Rochester, N. Y.



PRIVATE FAMILIES SUPPLIED.

GARIN & MEAGHER,

MANUFACTURERS OF

FINE CIGARS,

AND DEALERS IN

Smoking and Chewing Tobacco,

SNUFF, PIPES, POUCHES, &c.

No. 147 East Main Street, - ROCHESTER, N. Y.

Manufacturers of the "ORANGE BLOSSOM" CIGAR.

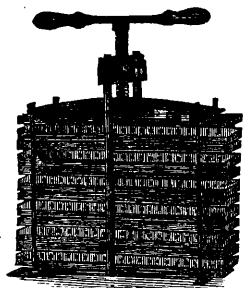

JACOB SAUER,

(BUTTS' BUILDING),

Aqueduct Street, - ROCHESTER, N. Y.

Manufacturer of Spanish Cedar and White-wood

CIGAR BOXES,

With all the Modern Improvements in Machinery.

Tuck Cutters, Labels, Edgings, Stencil Plates, Box Tacks,
Cigar Knives, Spanish Ribbons, &c., of Superior
Quality, constantly on hand.

Agent for the Celebrated German CIGAR MOULDS, Presses and Straps.

BLAKENEY & CO.,

Manufacturers of and Dealers in

CIGAR BOXES,

Edgings, Cigar Knives, Labels, Tuck Cutters, Spanish Ribbons,

STENCIL PLATES,

AMERICAN and GERMAN CIGAR MOULDS,

Office and Factory, 3 Aqueduct Street,

ROCHESTER, N. Y.

AUGUSTUS C. BLOXSOM,

"CRITERION"

TOBACCO AND CIGAR STORE,

AND DEALER IN

Smoking and Chewing Tobacco,

PIPES, POUCHES, &c.

319 STATE STREET, - ROCHESTER, N. Y.



W. S. KIMBALL.

J. C. HART.

WM. S. KIMBALL & CO.,

Manufacturers of the

“Peerless” AND “Vanity Fair”

TOBACCO.

Office and Factory : 53, 55 and 57 South St. Paul St., Rochester, N. Y.

M. J. DAMON,

MANUFACTURER OF

Choice Brands of Cigars,

ALSO, OF THE CELEBRATED

M. J. D. Brand,

No. 3 Eagle Street, Rochester, N. Y.

ESTABLISHED }
1860.

C. & G. GUCKER,

MANUFACTURERS OF

CUT TOBACCO and FINE CIGARS,

AND DEALERS IN

Leaf Tobacco,

Snuff and Plug Tobacco.

Salesrooms, Office and Factory:

MILL, corner Factory Street,
ROCHESTER, N. Y.



COURTNEY & HENRY,

Manufacturers of all Brands of

DOMESTIC CIGARS,

341 STATE STREET,

ROCHESTER, N. Y.



R. & T. WHALEN,
 MANUFACTURERS OF
TOBACCO AND CIGARS,
 AND DEALERS IN
SNUFF, PIPES & LEAF TOBACCO,

No. 182 State Street, - ROCHESTER, N. Y.

ESTABLISHED, 1838.

S. F. HESS,

Manufacturer and Wholesale Dealer in

Tobacco, Snuff and Cigars,

Office, No. 7 Exchange Street,

MANUFACTORY,
 Nos. 21, 23 and 25 West Main Street, } ROCHESTER, N. Y.

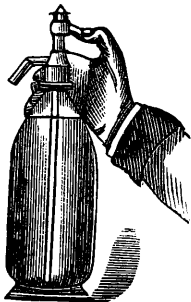

H. H. SCHNARR & BRO.,
MINERAL SPRING WATERS,

114 North Clinton St., Rochester, N. Y.

Sellers, Vichy (Grande Grille), Kissengen (Rakoczy), Carbonic Acid Water,

And all other MINERAL SPRING WATERS, in
SYPHONS, GLASS AND JUGS.

We are sole agents in Rochester for the celebrated

"DEEP ROCK" SPRING WATER OF OSWEGO.

IRA A. LOVEJOY,

MANUFACTURER OF

PURE CANDY,

12 Main Street Bridge, Rochester, N. Y.

NO COLORING OR OTHER OBJECTIONABLE MATTER USED.

Only the Highest Priced Material used.

SPECIALTIES.—Butter Creams, Fruit Cream, Ice Cream Candy, Grenoble Cream, Molasses Cream, and many others.

WHITCOMB HOUSE,

WHITCOMB & CROUCH, Propr's.

No. 110 East Main Street, - - - Rochester, N. Y.

CHAPMAN HOUSE,

40 to 46 South St. Paul Street, - - - Rochester, N. Y.

GEO. H. CLUTE, Proprietor.

Nearly opposite the Opera House, and a few rods South of the Osburn House.

OSBURN HOUSE,

East Main Street,

Corner North St. Paul.

D. H. BROMLEY, }
C. P. BROMLEY. }

BROMLEY & CO.

BRUCE'S HEMLOCK WATER BATHS:

Bathing and Hairdressing Rooms,

—ALSO,—



CITY STEAM LAUNDRY.

☛ GOODS RETURNED PROMPTLY. ☚

No. 5 Exchange Street, - - - Rochester, N. Y.

HOFFMAN & MAYER, UNDERTAKERS

AND DEALERS IN

Coffins, Caskets, Robes,

And all kinds of

FUNERAL FURNISHING GOODS.



No. 10 Allen Street, - Rochester, N. Y.

J. MAYER, residence 30 King Street.

Branch Store, managed by HOFFMAN, MAYER & STREB, 37 ANDREWS STREET.

FÖEHNER & MAIER, UNDERTAKERS,

AND DEALERS IN

Coffins, Caskets, Robes,

And all kinds of

UNDERTAKERS' FURNISHING GOODS.

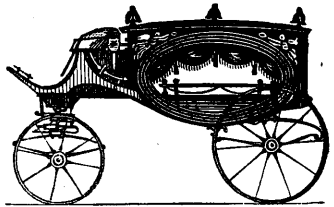

HEARSEs and HACKS Furnished at all times when Desired.

4 North Clinton Street, Rochester, N. Y.

AUGUSTUS C. BLOXSOM, CRITERION

Shaving and Hair Dressing Parlor, GENTS' FURNISHING GOODS.

No. 319 State Street, Rochester, N. Y.

(GILLETT BLOCK.)



COOLIDGE SCHOOL OF DESIGN
—AND—
Parlor Studio of Painting and Drawing.
WASHINGTON HALL BLOCK.

Extra facilities offered parties desirous of perfecting themselves in the Arts.
No person should think of traveling abroad without being able to sketch from nature.
Visitors are cordially received. Calling hours from 10 to 12 a. m. and from 3 to 4 p. m.
Portraits, Scenery and Caricatures to order, satisfaction guaranteed. **C. M. COOLIDGE,**
(¹ Kash.)

COOLIDGE BROTHERS, DRUGGISTS,

124 East Main Street.

ROCHESTER, N. Y.

All Goods First Quality. Prices Reasonable.

CALL AND SEE US.

SARAH A. HIBBARD, M. D.,

DEALER IN

Pure Drugs and Toilet Articles,



PHILADELPHIA PHARMACY.

Ladies' Drug Store,

East Avenue, near Alexander Street,

Established 1870.

ROCHESTER, N. Y.

Dr. Hibbard's Office Hours: 10 to 11 A. M.; 3 to 5 P. M.

HENRY AMAN,

DRUGGIST,

—AND—

DEALER IN FANCY GOODS,

No. 139 East Main Street, - Rochester, N. Y.

PALACE DRUG STORE.

F. X. WEIGEL,

Druggist and Apothecary,

KEEPS A COMPLETE STOCK OF

Drugs, Medicines, Perfumery, Toilet Articles, Trusses,

ALL KINDS OF PATENT MEDICINES, ETC.

Physician's Prescriptions Prepared Day and Night.

No. 57 NORTH CLINTON STREET, ROCHESTER, N. Y.

Commissioner of Deeds, Conveyancer, &c.

A. HAMBLETON,

(Successor to RICE & HAMBLETON),

Druggist and Pharmacist,

No. 111 Plymouth Avenue,

Corner Tremont Street.

ROCHESTER, N. Y.

Prescriptions Carefully Prepared at all hours of the day or night.

SOUTH AVENUE DRUG STORE.

FRANK L. HEWITT,

(Successor to HENRY EATON.)

DRUGGIST, APOTHECARY AND NEWSDEALER,

44 South Avenue, Rochester, N. Y.

Drugs, Fancy Goods, Toilet Articles, Wines and Liquors for Medicinal purposes. All the current, trustworthy PATENT MEDICINES constantly on hand.

Physicians' Prescriptions Carefully Compounded at all hours.

RESIDENCE SAME NUMBER.



ESTABLISHED 1845.

J. P. IRISH,

Successor to S. KERSHAW,
DEALER IN

DRUGS, MEDICINES and CHEMICALS.

FANCY and TOILET ARTICLES,

SPONGES, BRUSHES, PERFUMERY, CHOICE CIGARS, &c.

255 State St., corner Brown St.,

ROCHESTER, N. Y.

Physicians' Prescriptions carefully compounded and orders answered with care and dispatch.



\$500 IN GOLD!

AFTER YOU HAVE TAKEN ONE BOTTLE OF

Dr. Taft's White Pine Syrup,

For Coughs, Colds, Asthma, Croup or Consumption, or a bottle of

TAFT'S SURE RELIEF

For Neuralgia, Headache, Colic, Cholera Morbus, Diarrhoea, or any pain you may have. Or one Box of

BROWN'S DOMESTIC SALVE

For the worst case of Piles, Fever Sore, Broken Breast, Milk Leg, &c., you will say that they are worth FIVE HUNDRED DOLLARS IN GOLD.

TAFT BROTHERS, Physicians and Druggists,

Store and Office, 146 West Main Street.

C. E. STEVENS,

62 West Avenue, Rochester, N. Y.

DEALER IN

Drugs, Medicines and Chemicals,

FANCY AND TOILET ARTICLES,

Sponges, Brushes, Perfumery, &c.

Prescriptions carefully Compounded with accuracy and dispatch by competent persons, at all hours of the day and night.

Union Ice Company,

OFFICE, 136 STATE STREET.

(GRAY'S GROCERY STORE.)

Hotels, Saloons, Families, Butchers, Fishermen,
Offices, &c., Supplied as low as any
Company in the City.



ORDERS RECEIVED BY MAIL PROMPTLY ATTENDED TO.

P. HORTON.

Residence and Ice House, Rowe Street, near Erie Canal and Driving Park.

German Crystal Ice Co.

JOHN FOOS, Prop'r.

Delivers the Best



PURE WHITE ICE.

OUR OFFICE IS ONLY AT

126 LYELL STREET,

Where all Orders must be addressed.

C. H. FINCH,

DEALER IN

PURE ICE.

Families, Markets and Saloons Supplied
at the Lowest Possible
Rates.



OFFICE, 134 STATE STREET,

RESIDENCE, Rowe Street, near Erie Canal, near the Rochester Driving Park,

ROCHESTER, N. Y.

T. M. JOSLIN,

Milk and Cream Dairy,

156 State Street, Rochester, N. Y.

Pure Milk, Sweet Cream, Ice Cream, Buttermilk, Cottage Cheese, &c.

FAMILIES, HOTELS, RESTAURANTS, PIC-NICS, FESTIVALS, SOCIALS, ETC..

SUPPLIED ON REASONABLE TERMS.

CITY DELIVERY FREE.

SPRING FOUNTAIN LAKE



WILLIAM EMERSON,

322 North St. Paul Street,

Has taken re-possession of this estate, and will furnish this celebrated "Pure White Ice," after December 1st, 1876.

Proprietor of the

ROCHESTER BATTING MILL.

No. 153 North Water Street, - - - ROCHESTER, N. Y.

BECKER'S

N. Y. C. & Erie Ticket & Baggage Express,

IN AND TO

All Parts of Rochester.

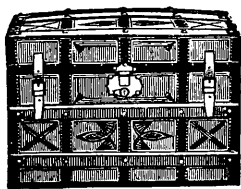

CHECK STAND:

New York Central Depot,



GENERAL TICKET OFFICE:

51 West Main, cor. Exchange St., Street Car Waiting Room,

Tickets for sale to any point on all Railroads, at the same price as at the Depot. Agent for Wagner's Sleeping and Drawing-room Cars. Baggage Checked from this office, or from residence. The only Company in the city who can check direct to destination.

ORDER SLATES AT

Osburn House Drug Store; Whitcomb House; National Hotel and Chapman House; Farmers' Hotel; Klem's Fruit Store, cor. Franklin and Main Streets.

Orders should be left 3 Hours in Advance of Train Time.

SUNDAY OFFICES.—Check Stand, N. Y. C. Depot; Whitcomb House and National Hotel.

FLOUR CITY SPICE MILLS.

ESTABLISHED IN 1844.

M. N. VAN ZANDT & CO.,

JOBBER IN

Teas, Coffees and Spices,

AT NEW YORK PRICES.

TEAS A SPECIALTY.

MANUFACTURERS OF THE

“Flour City” Baking Powder.

No. 11 WEST MAIN STREET,

M. N. VAN ZANDT, }
I. F. FORCE. }

ROCHESTER, N. Y.

ESTABLISHED 1844.

FLECKENSTEIN BROS., STEAM BAKERY,

Manufacturers of the Celebrated

Patent “Eureka Bread,”

UNSURPASSED FOR HEALTH OR DELICACY.

Also Manufacturers of all kinds of

CRACKERS AND BISCUITS.

Sole Makers of Holmes' Patent Ginger Snaps, Lemon
Snaps, Jumbles, &c.

Corner Brown and Maple Streets,

ROCHESTER, N. Y.

V. FLECKENSTEIN, JR.

GEO. FLECKENSTEIN.

JOSEPH FLECKENSTEIN.

ONE PRICE. - SALES FOR CASH.

MOORE & COLE,

WHOLESALE AND RETAIL



GROGERS AND PRODUCE DEALERS,

A Large Line of

FOREIGN FRUITS, CANNED GOODS, &c.

Choice Teas and Pure Coffees Specialties.

No. 72 West Main Street, formerly Buffalo St.,

ROCHESTER, N. Y.

Powers' Commercial Buildings.

DUNLEVY & DELAVAU,

DEALERS IN

FINE GROCERIES

OF ALL KINDS.

Specialty of Sugars, Teas, Coffees, and Spices.

CHOICE

Family Flour.



Please give us a call before purchasing elsewhere, at

No. 28 Allen Street, corner Sophia,

JOHN DUNLEVY,
JOSEPH S. DELAVAU.

ROCHESTER, N. Y.

H. F. HEMINGWAY & CO.,

PACKERS OF

Baltimore Oysters

—AND—

CANNED GOODS,

WHOLESALE DEALERS IN

FOREIGN FRUITS and CONFECTIONERY

123 State Street, Rochester, N. Y.

H. F. HEMINGWAY & Co., New York City. H. F. HEMINGWAY & Co., Albany, N. Y.
 H. F. HEMINGWAY & Co., Baltimore, Md. H. F. HEMINGWAY & Co., Syracuse, N. Y.
 H. F. HEMINGWAY & Co., Fair Haven, Conn. H. F. HEMINGWAY & Co., Norfolk, Va.
 H. F. HEMINGWAY & Co., Crisfield, Md.

J. MOGRIDGE,

DEALER IN



ALES, WINES, LIQUORS AND CIGARS,

Flour, Graham Flour, Oat Meal and Corn Meal,

Also, A FIRST-CLASS MEAT MARKET,

23 & 25 Spring Street, and 36 Plymouth Ave.,

ROCHESTER, N. Y.

CHARLES L. SMITH,

BUILDER OF



Shells, Barges, Gigs and Pleasure Boats,

Of every Description. Also, SCULLS and OARS.

MT. HOPE AVENUE,

On the River Bank, opp. No. 53 Mt. Hope Av. ROCHESTER, N. Y.

WEST AVENUE POTTERY.

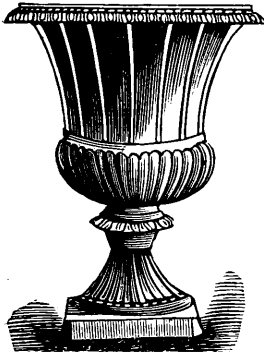

J. M. HAMMER,

MANUFACTURER OF

Machine and Hand-Made

FLOWER POTS,

For Nurserymen, Florists and Amateurs.

Hanging Baskets, Vases, Etc.

—ALSO,—

MANUFACTURER OF EARTHEN WARE,

151 West Avenue, Rochester, N. Y.

Rochester Croquet Manuf'y

HOWES & BEEBÈ,

Manufacturers of

CROQUET

AND OTHER GAMES,

111 1/2 North Water Street,

ROCHESTER, N. Y.

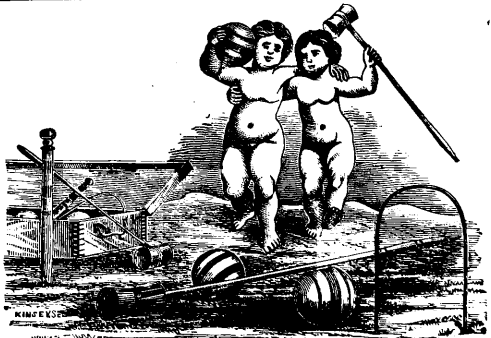

MRS. G. W. GALLIGER,

MANUFACTURER OF

NEWEL POSTS, HAND RAILS, BALUSTERS, ETC.,

Carved Machine Mouldings

House and Cabinet Mouldings,

CABINET MAKERS' TURNED STUFFS,

All Kinds of Turning Performed to Order.

Also Sawing with Upright and Buzz Saws.

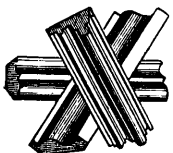

No. 3 Aqueduct Street,

ROCHESTER, N. Y.

Catalogues.

Price Lists.



VACUUM OIL COMPANY'S
 BOOK AND JOB
PRINTING OFFICE
 Over 6 and 8 State Street,
 (Opp. Powers' Block,) **Rochester, N. Y.**



Law Work.

Office Work.

DESIGNED AND PRINTED BY
WHYBREW & HACKES
Managers.

Lockhart & Leadley,
 ARTISTIC
Designing and Engraving
On Wood,
 24 East Main Street, Rochester, N. Y.

WATCHES. DIAMONDS. JEWELRY.

C. F. WOLTERS,

MANUFACTURING JEWELER,

AND DEALER IN

Clocks, Silver and Plated Ware,

No. 30 WEST MAIN STREET,

Entrance Reynolds' Arcade.

Rochester, N. Y.

3d Ward Boot Manufactory.

SPAULDING & MARTIN,

Manufacturers of Fine

BOOTS AND SHOES,

TO MEASURE.

Being Practical Workmen, and using only Good Stock,
we Guarantee Satisfaction. Repairing done
Neatly.

No. 114 PLYMOUTH AVENUE,

ROCHESTER, N. Y.

F. TULLEY,

STOVES, FURNACES, RANGES,

PLUMBING,

Hot Air Pipes, Registers, Ventilators, House Furnish-
ing Goods,

FOUNTAINS AND VASES,

REPAIRING.

63, 65 & 67 Exchange Street, - Rochester, N. Y.

D. W. WRIGHT.

W. R. PETERS.

W. R. CRAIG.

D. W. WRIGHT & CO.,

WHOLESALE MANUFACTURERS OF

Men's, Boys', Ladies', Misses' Youths' and Children's

FINE SHOES,

73 N. Water St., Rochester, N. Y.

ELIAS HOWE, {
1846.

THE

{ IMPROVED
1874.

NEW IMPROVED FAMILY

Elias Howe Machines.

"These Machines have stood the test of years, and now with the LATE IMPROVEMENTS, LIGHT RUNNING and EASE OF MOTION are unequalled by any on the market."

THE HOWE MACHINE COMPANY,

C. S. TODD,
Manager.

69 STATE STREET,
ROCHESTER, N. Y.

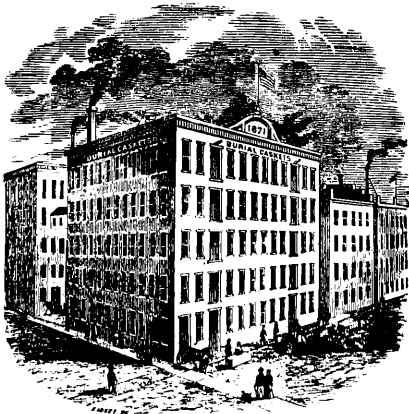

Maxwell, Newman, McManis & CO.,

MANUFACTURERS OF

SUPERIOR

Burial Cases,

OFFICE,

No. 22 South St. Paul Street.

FACTORY,

Nos. 22, 24 and 26 Minerva Street,

ROCHESTER, N. Y.

FAIRPORT NURSERIES.

J. Y. PARCE, Proprietor,

PROPAGATOR OF

General Nursery Stock,

Fruit and Ornamental Trees, Vines, Shrubs, Roses, &c.

Grounds and Office, opposite New York Central Railroad Depot.

"ROGERS" AND OTHER CHOICE GRAPES A SPECIALTY.

Also, offers for sale a very desirable plot of BUILDING LOTS, near the Depot—fully improved.

Twelve Passenger Trains stop at our door daily.

FAIRPORT, Monroe County N. Y.

S. C. VAN HOESEN,

MANUFACTURER OF

Sash, Blinds and Doors,

House Mouldings and Brackets,

No. 15 Warehouse Street,

ROCHESTER, N. Y.

Having resumed business, and feeling thankful for favors in the past, I respectfully solicit a share of your patronage in the future. It will be my pleasure to suit in quality and price. Orders will receive prompt attention.

RESIDENCE, 140 FRANK STREET,

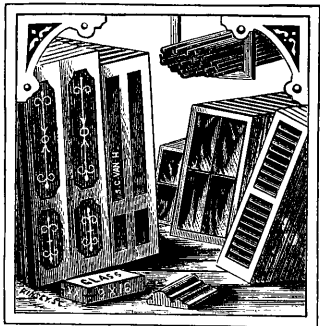

WEST END POULTRY YARD.

J. W. VAN VECHTEN,

Importer and Breeder in

Prize Fowls, BRIGGS' PLACE.

We have the choicest Fowls ever grown in Western New York, including White, Buff and Partridge Cochins, Light Bramas and B. B. Bantams, of all the first-class strains in the country. Eggs for Breeding purposes for sale on reasonable terms.

Orders may be left at my Rooms, 35 State Street.

J. W. VAN VECHTEN & CO.,
Silk Hat Manufacturers,
35 State Street,

Room No. 18.

ROCHESTER, N. Y.

J. W. VAN VECHTEN,

T. C. FLETCHER.

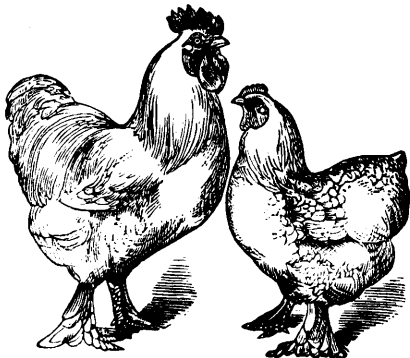

The Old and Responsible.

D. LEARY'S STEAM DYEING

AND
Cleansing Establishment,

200 YARDS NORTH OF N. Y. C. R. R. DEPOT, MILL STREET, COR. PLATT.

Ladies' and Gentlemen's Garments Cleaned or Colored without ripping, and pressed nicely. Also, Feathers and Kid Gloves Cleaned or Colored. Special attention paid to doing up LACE CURTAINS and Coloring Velvets.

Goods Dyed Black every Tuesday, Thursday and Friday.

Packages called for and Delivered to any part of the City. Goods returned in One Week. Goods Received and Returned by Express. Bills Collected by Express Company.

I have no Agents, as customers can do their business with me cheaper than through an Agent.

Address,

D. LEARY,

Mill Street, corner Platt Street, Rochester, N. Y.

GEORGE BECK,

Having quit doing business at No. 4 MILL STREET, Rochester, would request that all orders for Wines or Brandies, or other business matters, be directed to him

AT CHARLOTTE, N. Y.

DEALS IN

Pure Wines and Brandies,

OF HIS OWN MANUFACTURE,

And also all other Liquors usually Sold,

And he claims to sell

PURER and FINER BRANDY

Than any other Liquor Merchant in Rochester.

HE KNOWS WHAT HE SPEAKS OF,

For he has had his Brandy analyzed, and also that imported by the Liquor Merchants. At all events, HE WILL BACK UP what he asserts.

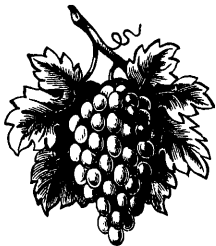

F. C. LAUER & CO.,

Manufacturers and Dealers in a Superior Quality of

QUICK LIME AND BUILDING STONE.

Special Attention Given to the Shipping of Lime.

Office, No. 35 Powers' Block, - Rochester, N. Y.

Lime Kiln on Buffalo Road, near Central Railroad. Quarries on North Ave., near Clifford Street, and on Clifton Street, near Genesee.

Order Slates for Lime at KINGSLEY & Co.'s, 112 East Main Street, and at HAMILTON & MATTHEWS, 21 West Main Street.

J. W. GARBUTT,

MANUFACTURER OF

Water Lime & Land Plaster,

Scottsville, Monroe County, N. Y.

MILLS AT GARBUTTSVILLE, MUMFORD AND SCOTTSVILLE.

CITY DEPOT, Stone Warehouse, Childs' Slip,

Rear of 85 Exchange Street, near Court St.. - ROCHESTER, N. Y.

STREET NUMBERS

FOR SALE AT

DIRECTORY OFFICE, - 114 Powers' Buildings.

White Metal Figures,	Height 1½ inches.	Silver Close Plated Figures,	Height 2 inches.
Nickel Plated "	" 2 "	Enameled Tin, Gold "	" 2 "
Electro-Silver Plated Figures,	" 2 "	Prices, 10c. to 50c. Per Figure.	

—ALSO,—

Engraved Silver Door Plates and Numbers,

OF SUPERIOR QUALITY AND WORKMANSHIP.

DREW, ALLIS & CO.

EXCELSIOR FILE WORKS

GEO. F. STOTT,

MANUFACTURER OF

FILES AND RASPS

15, 17, 19, 21, & 23 River Street, cor. N. Water Street,

East End of Railroad Bridge.

ROCHESTER, N. Y.

Files RE-CUT and warranted to wear equal to new. We pay Freight one way on Old Files, but not Express. Send for Price List. Address Packages to

GEO. F. SCOTT, Rochester, N. Y.

CHARLES H. TURVER, CONTRACTOR and PRACTICAL BUILDER

39 S. Ford Street, West end of Spring Street,
ROCHESTER, N. Y.

Estimates given and Contracts taken for all kinds and Styles
of Buildings.



The Higher Branches of Carpenter and Joiner Work done in
the most Substantial and Workmanlike Manner.

CISTERNS KEPT ON HAND AND MADE TO ORDER.

Mason Work,

In all its branches, promptly executed on short notice. LIME
AND MORTAR KEPT ON HAND.

House Painting.

I am prepared to take orders for House Painting, and can
furnish superior materials for doing satisfactory work.

All work done under my own supervision, and warranted per-
fect. Job work of all kinds promptly attended to.

PROF. JOHN REYNOLDS,

The Celebrated

English Mesmerist and Magnetist,

Who has for 21 years made Nervous Diseases a Specialty, cures the following
diseases by

MAGNETIC TREATMENT,

Paralysis, Rheumatism, Neuralgia, Sciatica, Deafness, Amor-
ousis, Female Difficulties, and all other Nervous
Diseases.

The following Medical Gents say that he possesses the strongest magnetic power
ever witnessed:

LOCKPORT, N. Y.

A. J. EVANS, M. D.
R. DAVIDSON, M. D.

A. WALTER TRYON, M. D.
C. N. PALMER, M. D.

D. T. BISHOP, M. D.
S. T. CLARK, M. D.

ROCHESTER, N. Y.

R. LAWDER, M. D. H. LEWIS, M. D. G. W. PEER, M. D. D. M. SHIPMAN, M. D.

Rooms, 40½ Fitzhugh Street,

Howe's Block, Room No. 2.

ROCHESTER, N. Y.

FRED. TURPIN,

Manufacturer and Dealer in

PIER AND MANTEL MIRRORS,

—AND—

LOOKING GLASSES,

OF EVERY DESCRIPTION,

French, German and American Plates, Fine and Cheap Frames of every description, Picture Glass, Window Cornices, Velvet Goods, Mats, Passepartouts, Picture Cord, Nails, Screw Eyes, and all goods connected with our trade.

110 Front Street, - ROCHESTER, N. Y.

WHITE BROTHERS, FLORISTS,

GREENHOUSES,
THURSTON STREET.

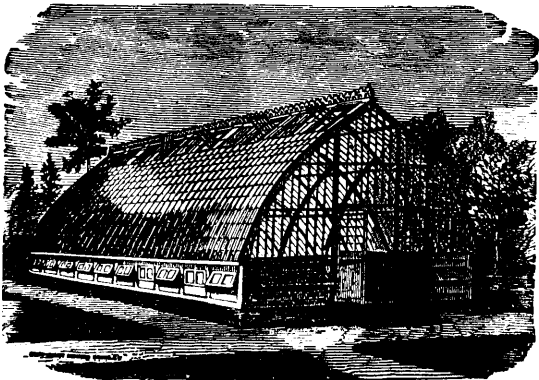

ONE MILE WEST AND SOUTH OF
ST. MARY'S HOSPITAL.

CUT FLOWERS A SPECIALTY

Bouquets, Wreaths and Crosses. Bedding Plants in Great Variety, and at Lowest Prices. Plants at Wholesale.

P. O. Address, WHITE BROTHERS, No. 21 South Clinton Street, ROCHESTER, N. Y.

WORLD'S PRIZE MEDALS.

London, 1862.

Paris, 1867.

Vienna, 1873.

Gold Medal, United States; Decoration Grand Gold Cross of Honor, Vienna, 1873; Gold Medal of Progress, 1873, awarded

F. S. PEASE'S IMPROVED OILS

As THE BEST IN THE WORLD for

Railroads, Steamers, Machinery and Burning.

Engine, Signal, Cylinder, Lard and Compound Coach Oils,

Endorsed by experience and test of years, and the highest authority of the United States and Europe.

PEASE'S PREMIUM PETROLEUMS AND HEAD-LIGHT OILS,

Extra High Fire Test.

DARK AND NATURAL OILS

F. S. PEASE, Manufacturer of Oils,

65 and 67 Main Street,
82, 84 and 86 Washington Street,

BUFFALO, N. Y.

ASK YOUR GROCER FOR

Best Chemical

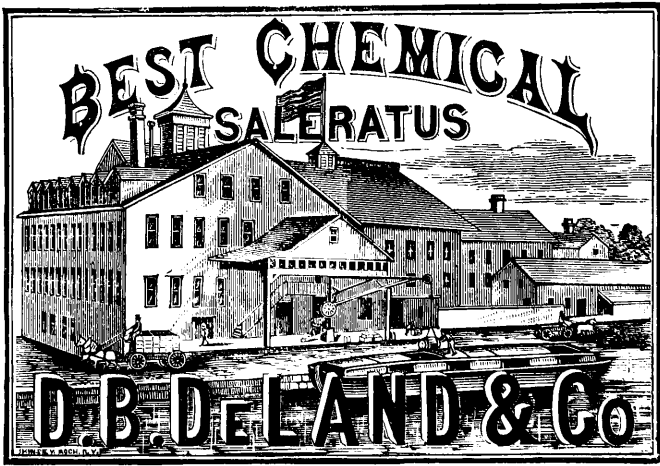

SALERATUS.

It is **CHEMICALLY PURE.** It is **UNIFORM** and **ALWAYS RELIABLE.**
You save money by using it instead of other Brands of
Saleratus, Soda and Baking Powder.

Made by **DE LAND & CO.,**
FAIRPORT, N. Y.

S. A. NEWMAN,

MANUFACTURER OF

“PURE GOLD”

BAKING POWDER,

—AND—

NEWMAN'S

Cream of Tartar.

WHOLESALE DEALER IN

MUSTARDS, PURE SPICES, SALERATUS, SODA, Etc.

Address at FAIRPORT, N. Y.

Mr. J. NEWMAN (Office with S. A. Newman), Manufacturer of
FINE PERFUMERY.

ESTABLISHED 1853.

H. THOMPSON,

MANUFACTURER OF

STAPLE SOAPS,

270 to 278 Perry Street,

—AND—

233 to 241 Chicago Street,

BUFFALO, N. Y.

BOOTH, RIESTER & CO.,



29 Pearl Street, Buffalo, N. Y.

Specimens Sent on Application.

ERDLE & OLIVER,

(Successors to the EMPIRE GRAIN DECORTICATOR COMPANY),

MANUFACTURER OF THE IMPROVED

UNITED STATES BRAN DUSTER,
Hutching's Gradation Grain Separator,

Bran Duster Brushes, and Wire Zinc Screens, &c., furnished at the
Lowest Cash Prices.

Manufactory and Office, Mill St., cor. Brown, - Rochester, N. Y.

P A T E N T

FOUR-SIDED MOULDING MACHINES,

EIGHT DIFFERENT STYLES
AND SIZES. Also,

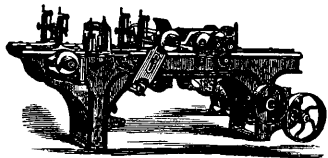

Moulding Cutters,

of every style, manufactured by

H. A. LEE,

EXCHANGE, Cor. Union Street, - WORCESTER, MASS.

C. H. UPTON,

REAL ESTATE OFFICE,

REMOVED from 61 Powers' Block, to

22 SMITH'S BLOCK, ROCHESTER, N. Y.

HOUSES, FARMS, BUILDINGS, LOTS, ETC.,

For Sale or Exchange on Reasonable Terms.

McMAHON & HAGAMAN,
 (Successors to J. RAPALJE'S Genesee Seed Store),
 Wholesale and Retail Dealers in

All Kinds of SEED,

AND

**Agricultural Implements,
 SUPER-PHOSPHATE, &c.,
 LIGHT BUGGIES, FARM AND MARKET
 WAGONS.**

159 West Main Street, Rochester, N. Y.

M. J. McMAHON.

F. O. HAGAMAN.

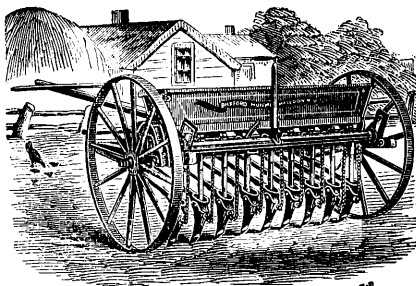

JOSEPH DAWES,

MANUFACTURER OF

ARTIFICIAL LIMBS,

170 West Avenue, Rochester, N. Y.

With an experience of fifteen years in the manufactory of the late Dr. BLY, we can guarantee a limb which shall give perfect satisfaction.

REPAIRS OF ARTIFICIAL LIMBS OF ANY MAKE.

W. SUMMERHAYS, Agt.,

MASON, BUILDER AND CONTRACTOR.

All kinds of **JOB WORK** in **MASONRY.**

FIRE MASONRY AND SEWERS A SPECIALTY.

Residence, 56 West Alexander Street.

J. N. SPINNING,

(Successor to J. HAWKSWORTH),

CUSTOM TAILOR,

128 West Main St., Rochester, N. Y.

CUTS AND MAKES GENTS' AND BOYS' CLOTHING.

Clothing Cleaned and Repaired.

D. KRAFT.

CHAS. SIEBERT.

KRAFT & SIEBERT,
CONTRACTORS,
 Carpenters and Builders,

Are prepared to Contract for BUILDINGS of all classes. JOBBING Attended to Promptly.

Shop, Ringelstein Alley, off 154 North Clinton Street,
 ROCHESTER, N. Y.

SHAW'S BRITANNIA METAL PIPE,
 —AND—
Patent Britannia Metal,
ROLLED INTO SHEETS.

*Acknowledged to be the BEST WATER PIPE known. Free from Lead Poison. Equal to Silver Pipe for purity.
 For Prices, &c., apply to*

E. L. THOMAS, Agent,
 93 South St. Paul Street, Rochester, N. Y.

R. & W. WILLIAMSON,
Carpenters and Builders,

TANKS and CISTERNS Made to Order.

Rear of 8 Allen St.,

R. WILLIAMSON, Residence, 6 Smith St.
 W. WILLIAMSON, Residence, 74 Walnut St.

ROCHESTER, N. Y.

All Orders and Jobbing Promptly Attended to,

Established 1842.

GEO. G. WANZER,

(Late H. C. WANZER & SON),

DENTIST,

Nos. 14, 16 and 18 W. Main Sts., Rochester, N. Y.

WE MANUFACTURE

DENNISON'S

IMPROVED RELIABLE

Patent Shipping Tags

Used by all the principal Express and Transportation Lines.

Dennison's Cheap Metal Eyelet, Manilla, Linen
and Parchment Tags.

DENNISON'S MERCHANDISE TAGS,

*For Dry Goods, Woolens, Clothing, Hardware, Fancy Goods, Jewelry, &c. Gun
Labels, Notarial and Legal Seals, Fancy Tickets, etc., etc.*



FINE and COMMON

PAPER BOXES,

For Jewelers and Druggists.

PINK AND WHITE COTTON. JEWELERS' CARDS.

*Selling Agents for McGill's Patent Paper Fasteners, Phillips' Patent Hook Tags,
Dennison's Strong Sealing Wax, Am. Paper Box Co.'s Drug Boxes,
Dennison's Apothecaries' Papers, Rouged and Plain
Chamois, and Fine Tissue Papers.*

All at Wholesale by Dealers in such articles, and at Wholesale or Retail by

DENNISON & CO.,

19 MILK STREET, BOSTON,
198 BROADWAY, NEW YORK,
632 CHESTNUT ST., PHILADELPHIA,

150 SO. CLARK STREET, CHICAGO,
4TH & VINE STREETS., CINCINNATI,
110 PINE STREET, ST. LOUIS.

M. HENRICUS & SON, BUILDER & CONTRACTOR

Will Furnish Estimates For Any Class of Buildings.

ADDRESS AT RESIDENCE,

No. 2 Hanover, Corner Hope Street, - ROCHESTER, N. Y.

L. D. GRAHAM,

CARPENTER & JOINER,

Bell Hanging, Plumbing, Lock Repairing, Painting,
Whitening, Paper, Hanging, Cleaning of Buildings, and
General Jobbing of all kinds promptly attended to.

Apply by P. O. Card or Personally.

House and Shop, 23 Ontario St., Cor. Tappan St.

DRESSES AND CHILDREN'S CLOTHING,

Made to Order by MRS. GRAHAM. Dress Patterns, Cloaks, &c., cut and sent by Mail everywhere,
and warranted a perfect fit.

In connection with our Business, we have opened a Store for the Sale of

FINE GROCERIES.

We will not be Undersold.

MORRIS LUCREE,

WOOD TURNING AND SAWING,

CARPENTER AND BUILDER,

Ames Street cor. Campbell, - Rochester, N. Y.

Wood Turning of every description, also Scroll and Circular Sawing done with neatness and dispatch.
Octagon and Fluted Balusters, also Newels and Rails constantly on hand or done to order.

Patterns, Models, Roped and Twisted work, Ten Pins and Balls. Indian Clubs, Mouldings, both
Straight and Circular, for Carpenters and Cabinet Makers and Piano Forte Manufacturers; in fact, all
trades supplied in their different branches.

N. B.—All Jobbing attended to at once, and done at reasonable rates.

MILLER & VAN SCHUYVER,

Contractors and Practical Builders,

SHOP, 147 WEST MAIN STREET,

Contracts taken for all kinds of Buildings; Stores fitted up, and Jobbing attended
to promptly. Cisterns kept on hand and made to order. Also builders of the Lyman
Improved Patent Refrigerators, for Meat Markets, Hotels, Saloons and Private Families.
Also, For Sale, the new

Patent Extension Curtain and Lambrequin Cornice Combined;

Adjustable to any sized window; made of Black Walnut, Chestnut, &c. Price from
75 Cents to \$1.50, Curtain Fixtures included. Call and see them.

JOHN B. PIKE,
B U I L D E R,

Carpenter Work in all its Branches.

JOBGING ATTENDED TO WITHOUT DELAY.

Shop, Minerva Place near E. Main Street,
ROCHESTER, N. Y.

LEON H. LEMPERT,

Artist in

FRESCO PAINTING,

TEMPORA AND CAUSTIC WATER-PROOF.

Scenes for Theatres, Halls and Traveling Companies,

No. 9 Howell Street, or Opera House, Rochester, N. Y.

PRIVATE HOUSE FRESCOING A SPECIALTY.

HAYKEN & HENSEL,

Fresco and Decorative Artists,

DESIGNS FOR INTERIOR DECORATION FOR

PRIVATE RESIDENCES, CHURCHES, HALLS, &c., &c.

Furnished on Application.

We also Superintend All Kinds of PLAIN PAINTING, and Guarantee Satisfaction.

Office, 88 and 89 Arcade,

ROCHESTER, N. Y.

D. P. DAVIS,

STREET AND SEWER CONTRACTOR,

Still continues in the business of Contracting.

PUBLIC OR PRIVATE STREET OR SEWER WORK EXECUTED.

73 South St. Paul Street,

Or, 8 Howell Street, - - ROCHESTER, N. Y.

EMPIRE NURSERIES,

G. G. McKINSTER, Proprietor.

Webster Plank Road, 1½ Miles from East Main Street, corner North, within City Limits, Rochester, N. Y.

A Choice Collection of Nursery Stock generally.

J. L. CURTIS, M. D.,

Can be consulted at his Offices as follows :

At his Pharmacy in Batavia, N. Y.,
Wednesdays and Saturdays.

At Powers' Building, No. 183, Rochester, N. Y.,

Mondays and Thursdays, from 7 A. M. to 4 P. M.

At Tift House, Buffalo, N. Y.,
1st and 3d Tuesdays of each month.

DR. BIRMINGHAM will assist DR. CURTIS in Rochester, and can be found at the Office, 183 Powers' Building, every forenoon.

CHAS. F. SCHULER,

Manufacturer of all kinds of

BUNGS, PLUGS AND SPILS,

For Brewers, Distillers, Oil Refiners,
Vinegar and Cider Manufacturers,

No. 131 North Water Street,

ROCHESTER, N. Y.

Orders Promptly Filled

ERNEST HART,

STEAM

Book and Job Printer,

46 Oak Street,

ROCHESTER, N. Y.

NEW

WILLCOX & GIBBS

AUTOMATIC TENSION

Silent Sewing Machine.

WILLCOX & GIBBS SEWING MACHINE CO.,

12 Allen Street,

ROCHESTER, N. Y.

L. P. ROSS,

WHOLESALE DEALER IN

BOOTS AND SHOES,

147 STATE STREET, ROCHESTER, N. Y.

JOHN T. FOX,

JEWELER,

No. 3 State Street, Powers' Fire-proof Buildings,

CORRECT STANDARD CITY TIME

Announced Daily at 12 M. on City Hall Bell,
by Fire Alarm Telegraph from
this Store.

RAILROAD TIME from the Dudley Observatory
received daily by Telegraph at 12 M.

C. E. FURMAN,

Merchant Tailor

—AND—

ONE PRICE CLOTHIER,

Cor. West Main and Front Streets,

ROCHESTER, N. Y.

ALLEN & WEGMAN,

Successors to F. P. ALLEN & CO.,

MANUFACTURERS OF

Rubber Hand Stamps,

SELF-INKING PRINTING WHEELS, DATING AND CANCELING STAMPS,
FAC SIMILES OF AUTOGRAPHS, ETC.,

FOR BANKS, RAILROAD, EXPRESS AND POST OFFICES. LAWYERS INSURANCE AND REAL ESTATE AGENTS. UNDERWEAR
MANUFACTURERS, BUSINESS PURPOSES GENERALLY, AND FOR PRINTING ON TIN, WOOD, GLASS, LEATHER, ETC.

ENGRAVERS & STEAM JOB PRINTERS.

Latest Styles in Wedding & Visiting Cards, Invitations, Monograms, Etc.

OFFICE AND MANUFACTORY:

Nos. 62 EAST MAIN & 2 SOUTH ST. PAUL STS.,

OPP. OSBURN HOUSE.

ROCHESTER, N. Y.

PATENT
Self-Inking Rotary Hand Stamp.

Entirely New and Perfect in Construction!

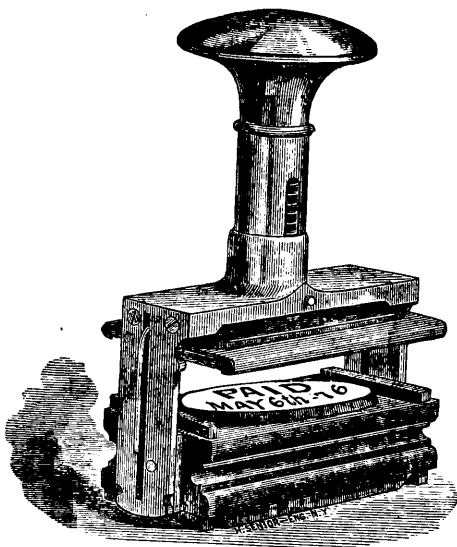

No Pads or Ribbons to annoy or trouble!

The great merit of this Stamp is that it does away with the use of a ribbon, or the cumbersome inking pad.

It has two similar Rubber dies, so arranged that while one is printing the other is being inked by a small pad concealed in the upper part of the Stamp. After an impression is made, the act of lifting the Stamp from the paper gives rise to a rotary motion, which brings the freshly inked type immediately into position for another impression.

The rapidity with which this change is made enables the user to make 60 impressions a minute with ease.

ALLEN & WEGMAN,
No. 62 E. Main Street.

JARVIS LORD & CO.,
 Distillers and Dealers in
LIQUORS,
WINES, &c.
69 Mill Street,
 Cor. Mumford, ROCHESTER, N. Y.

JOHN BAMBER,
 Manufacturer and Dealer in
STOVES,
 Tin, Copper and Sheet Iron Ware.
 Roofing, Gutters, Conductor Pipe and Job
 Work of every description done at
 Lowest Market Prices.
No. 11 Monroe Ave.,
ROCHESTER, N. Y.

W. H. REID,
 Importer and Grower of
Choice Seeds, Bulbs, Etc.,
 No. 166 State Street, - Rochester, N. Y.

FRED. D. ALLING,
 Manufacturer of
Superior Writing Inks,
 19 & 21 Mill Street,
 ROCHESTER, N. Y.

ALFRED WRIGHT,
PERFUMER,
 149 and 151 State Street,
 Opp. Waverley House,
 Rochester, N. Y.

LEAT & WEITZEL,
 FASHIONABLE
BOOT & SHOE MAKERS,
 127 Main Street, cor. Clinton, Rochester, N. Y.

Subscription Book Department.
D. APPLETON & CO.,
 549 and 551 Broadway,
NEW YORK.
 "THE ART JOURNAL,"
 "PICTURESQUE EUROPE,"
 Etc., Etc.
C. GLOVER, Agent,
 42 State Street, ROCHESTER, N. Y.

EUROPEAN
 Serial Subscription Book Office.
 THE ORIGINAL
 "Europe Illustrated,"
 Its Picturesque Scenes and places of note. Publish-
 ed by the London and New York Printing and
 Publishing Company, at 30 Cents per part,
 each part containing two beautiful
 Steel Plate Engravings.
 Also, Gustave Dore's Bible; Dore's Dantes Inferno;
 Purgatory and Paradise; Don Quixote; Illus-
 trated Shakspeare; Illustrated London;
 Travels all 'round the World; En-
 cyclopaedias, and all the best
 Serial Publications direct
 from Europe.
E. B. MAY, General Agent.
 45 East Main Street, Rochester, N. Y.

WALTER B. DUFFY & CO.,

Distillers and Rectifiers of

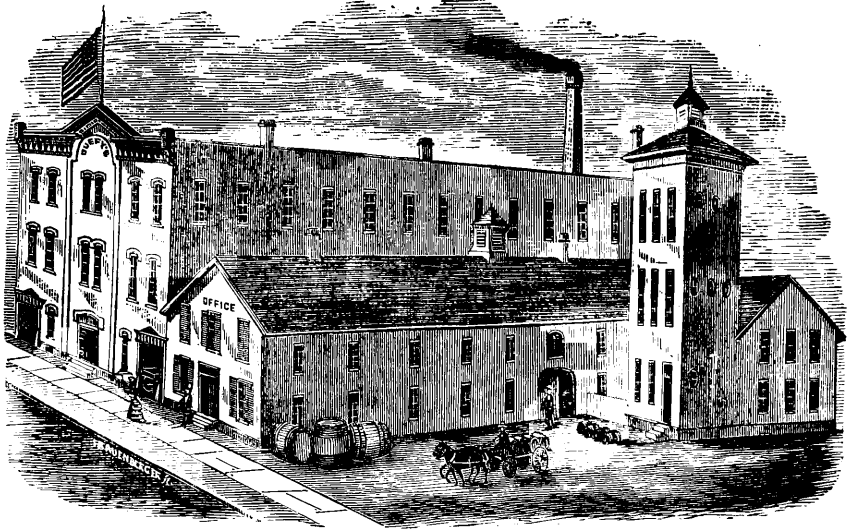

ALCOHOL, FRENCH SPIRITS,

MALT,
WHEAT,
RYE and
BOURBON

WHISKIES,

Also, Importers of

WINES AND LIQUORS,

And Manufacturers of

CIDER AND VINEGAR.

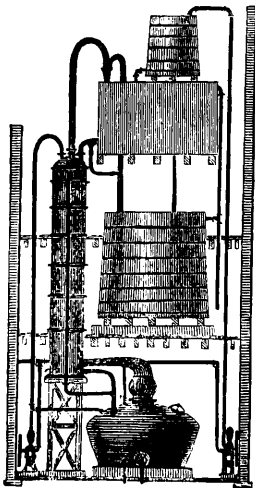

Nos. 8, 10 and 12 White Street, Rochester, N. Y.

☞ A new Brick Building, 50 x 132 feet, was erected during the year 1875, for the exclusive manufacture of CIDER and VINEGAR. State Street Horse Cars pass within a few feet of our Building.

GEORGE C MAURER, GENERAL MERCHANT,

WHOLESALE AND RETAIL DEALER IN

GROCERIES, WEST INDIA GOODS, PRODUCE, PAINTS, OILS,

Turpentine, Varnishes, Ropes, Twines, Carpet Warp, Single Cotton Yarn,
Seine Twine, Gilling Thread, Tar, Pitch, Rosin, Oakum,

SPORTING AND BLASTING POWDER,

Shot, Safety Fuse, &c. All kinds of Grass Seed, Clover, Timothy, Red Top,
and Canada Peas,

CANARY AND HEMP SEEDS.

EUROPEAN BANK AGENT.

Drafts on all cities in Europe. Collections made in any part of Europe.

Particular attention paid to the collection and settlement of inherited property.

EUROPEAN EXPRESS AGENT.

Merchandise and Money forwarded to any part of Europe.

EUROPEAN PASSAGE AGENT

For the Hamburg, North German, Lloyd's, Guion and Inman line of Steamers.

NOTARY PUBLIC.

SPECIAL ATTENTION given to making POWERS OF ATTORNEY for use in the GERMAN STATES, and to the collection of Claims through Powers of Attorney.

78 EAST MAIN STREET,

Rochester, N. Y



HOP BITTERS CO.

HOP BITTERS

For all Diseases of the

Stomach, Liver, Kidneys,
Urinary Organs, &c.

MANUFACTORY,

No. 50 MILL STREET,

ROCHESTER, N. Y.

A. T. SOULE, Pres't.

WILSON SOULE, Sec'y.

F. SCHWIKERT,

MANUFACTURER OF

Billiard, Bagatelle and Pigeon Hole Tables.

SMALL PRIVATE TABLES MADE TO ORDER.

Large Tables Cut Down and made into Bevel New Style to any size required, and made as good as new. Billiard Balls Re-turned and colored.

Ten-Pins and Balls Re-turned in first-class style. Also, all kinds of FINE WOOD AND IVORY TURNING.

I also furnish all kinds of BILLIARD MATERIALS, Best Rubber; or DELANCY'S PATENT STEEL SPRING CUSHIONS applied to Old Tables, at the Lowest Rates.

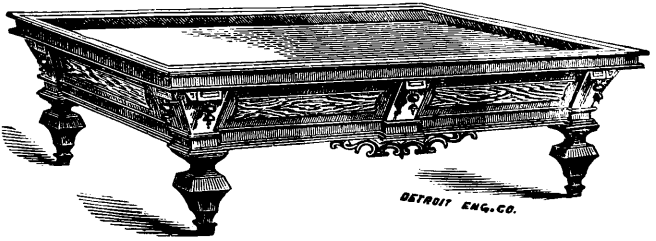

DETROIT ENG. CO.

ORDERS PROMPTLY ATTENDED TO.

Manufactory, 12 South Water St., Hall's Ag. W'ks.,
Billiard Rooms over 4 Mill St., Rear of Post Office.

Residence, 10 Buchan Park,
ROCHESTER, N. Y.

P. GERRES,

RETAILER OF CHOICE

ROCHESTER LAGER

ALES AND CIGARS,

No. 76 North St. Paul St.,

(OPPOSITE FALLS FIELD.)

ROCHESTER, N. Y.

ROGERS & CONVERSE, CARPET DEALERS,

14 Exchange Street,

LAFAYETTE ROGERS, }
CHAS. T. CONVERSE, }

ROCHESTER, N. Y.

COLUMBIA MUSTARD MILLS.

R. D. VAN DE CARR,

Manufacturer of all Grades of

English,
French and
American

DRY

MUSTARDS

31 Exchange St.,

ROCHESTER, N. Y.



ROCHESTER NEW PATENT

STEAM CARPET CLEANING WORKS,

No. 162 South St. Paul Street,

(BETWEEN MARSHALL AND GRIFFITH STS.)

Having secured Letters Patent for this city, for the best Machine for cleaning Carpets of every grade and fabric for Dwellings, Churches and Public Buildings, without injury to the finest fabric, and thoroughly frees the Carpets from dust, vermin and moths, beating and brushing them uniformly. Old Carpets made to look nearly like new. Carpets called for and returned without regard to weather. CARTAGE FREE.

Carpets put down at 4 and 5 cents per yard.
Orders left at my Office or by mail, promptly attended to.

PRICES FOR BEATING AND BRUSHING.

Ingrain, Three-ply and Cocoa	Brussels, - - -	6 cts. per Yd.
Matting, - - - 5 cts. per Yd.	All other kinds, - - -	8 " "

PETER LEINEN, Proprietor,
16 Years with HOWE & ROGERS.

N. L. PALMER.

F. D. PALMER.

N. L. PALMER & SON,
DEALERS IN
COAL and WOOD,

Baled Hay, Feed, &c.,
No. 83 Allen Street (Allen St. Bridge), Rochester, N. Y.

Orders through the Post Office Promptly Filled.

KNAPP & FISHER,
FALLS FIELD WOOD YARD

CORD WOOD, STOVE WOOD, HARD and SOFT KINDLINGS.

Yards: { *North St. Paul Street,*
23, 25 and 27 Pinnacle Ave., } - - - Rochester, N. Y.

SIX BARRELS OF KINDLING WOOD FOR ONE DOLLAR.

Wood delivered to any part of the city without extra charge. Orders sent through Post Office, C. O. D. will receive prompt attention.

GEO. J. KNAPP.

OTTO FISHER.

JOSEPH DOYLE,

CONTRACTOR AND BUILDER OF

YACHTS



AND ALL KINDS OF

Hunting and Pleasure Boats.

A SPECIALTY OF SAIL BOATS.

Particular Attention taken for Speed and Safety combined. REPAIRING done with neatness and dispatch.

CHARLOTTE, Monroe County, N. Y.

THOS. ELLWOOD.

F. C. ARMSTRONG.

ELLWOOD & ARMSTRONG,

PROPRIETORS OF THE NEW

Excelsior Flouring Mill,

Rear of 7 West Main Street,

Known as the ROBINSON BUILDING, will manufacture

FLOUR AND FEED OF ALL GRADES.

Custom Grinding to Order.

E. P. SNELL & CO.,

DEALERS IN

HARD **COAL** SOFT

No. 48 HUDSON STREET, ROCHESTER, N. Y.

Orders by Mail, or received at the Down-Town Office, 15 West Main Street,
will receive Prompt Attention.

L. C. LANGHE,

DEALER IN

SCRANTON AND PITTSTON
COAL.

Office, 154 East Main Street, corner East Avenue,

Yard and Office, No. 56 Hudson Street,
ROCHESTER, N. Y.

W. S. BAILEY,

DEALER IN ALL KINDS OF

ANTHRACITE COAL,

—ALSO,—

WOOD, HAY, STRAW AND OATS.

Yard and Office, Alexander Street Bridge, cor. Erie Canal.

To residents in this vicinity the Yard will be of great convenience.

POLLEY & CROFT,

DEALERS IN

PITTSTON AND WILKESBARRE COAL.

Office, No. 3 North Clinton Street,

Washington Hall Block,

ROCHESTER, N. Y.

Yard and Office, North Union Street, near the N. Y. Central Railroad.

WM. CUTTING, Veterinary Surgeon,

Cor. of North and E. Main Sts.,

ROCHESTER, N. Y.

Calls attended to at all hours of day or night.

Medicines constantly on hand for sale.

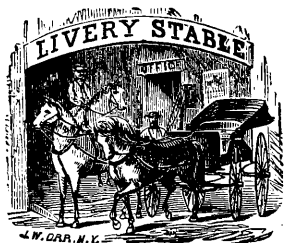
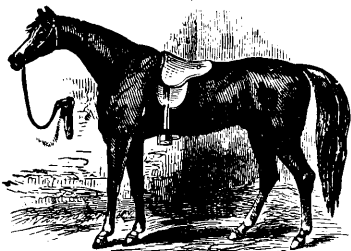

I. N. WRIGHT, *Livery, Sale and Boarding* **STABLE,**

17 Division Street,

Rear of the Osburn House, **ROCHESTER, N. Y.**

HORSES, BUGGIES AND HARNESSES ALL FIRST-CLASS.

*We have every Convenience for the Care
of Boarding Horses.*

I. N. WRIGHT, Proprietor.

M. GREENNAGEL'S Livery and Boarding Stables,

No. 6 Lancaster Street, near East Main,

ROCHESTER, N. Y.

Horses and Carriages furnished at short notice.
Stylish Open and Close Coaches for
Weddings, Parties, Funerals, &c.

Orders for **HACKING** Promptly
Attended to.

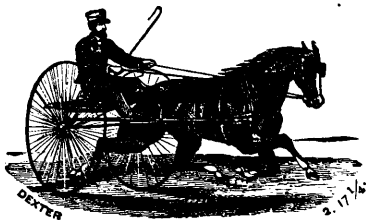

GOODWIN & MASON,

Manufacturers and Dealers in

CARRIAGES,

SULKIES, SLEIGHS, &C.,

Wood's Building, North Fitzhugh Street,

NEXT NORTH OF NATIONAL HOTEL,

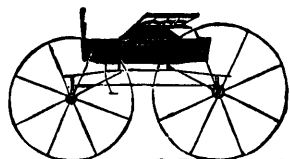

V. C. GOODWIN, }
J. CALVIN MASON. }

ROCHESTER, N. Y.

NORTH STREET CARRIAGE FACTORY.

DANIEL HYSNER,

COACH TRIMMER,

NORTH STREET CARRIAGE FACTORY.

Chatham cor. Franklin, and 17 North Street, Rochester, N. Y.

All Work Executed Promptly and Satisfactorily.

JOHN. RENAUD,

COACH PAINTER,

The finest branches of

Carriage Painting.

Refers to some of the best residents of Rochester.

NORTH ST. CARRIAGE FACTORY.

17 North Street, and Franklin Street.



JACKSON BAGLEY,

Carriage Maker.

All Classes of CARRIAGE WOOD WORK.

REPAIRING IN THE NEATEST MANNER.

17 North Avenue, - ROCHESTER, N. Y.

MICHAEL DWYER,

CARRIAGE AND WAGON MAKER,

26 VIENNA ST., ROCHESTER, N. Y.,

MANUFACTURES

Merchants' and Grocers' DELIVERY WAGONS.

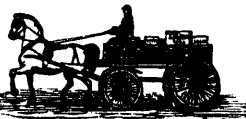

All kinds of Wagons, Buggies, Sleighs and Cutters made and repaired to order. Orders neatly and faithfully attended to, in repairing or making new, good, skillful work. Also, does a general business of

BLACKSMITH JOBBING.

GEORGE HAHN,
TRANSFER AND RAILROAD FREIGHT DELIVERER,
 Merchandise, Safes and Household Goods
 MOVED WITH GREAT CARE,
 No. 13 Andrews Street, - Rochester, N. Y.

All orders for the transfer or delivery of Freight to and from any part of the City left at Office, 13 ANDREWS STREET, near NORTH ST. PAUL STREET, and at the NEW YORK CENTRAL FREIGHT OFFICE, of J. B. HAHN'S 52 SOUTH ST. PAUL STREET, will receive Prompt Attention.

J. S. STONE & SONS'
 GENERAL
Merchants' Package and Baggage Delivery.

ORDERS LEFT AT

Sibley, Lindsay & Curr's, 73 East Main Street; Witherspoon's Grocery, 106 West Main Street; C. F. Paine & Co., Druggists, 20 West Main Street; Tower & Herrick's Bookstore, 6 Exchange Street; Amsden's Dry Goods Store, 36 State Street,

WILL RECEIVE PROMPT ATTENTION.



PACKAGES OR BAGGAGE TO ANY PART OF THE CITY FOR 25 CENTS.

Residence, 32 Atkinson Street, Barn, Greenwood Avenue, Rochester, N. Y.

THE OLD AND RELIABLE
BAGGAGE EXPRESS,
 Of PRATT & WEED,

May Always be Found on the Outside of the Depot, Rochester, N. Y.

PRINCIPAL OFFICE, 92 MILL STREET.

OFFICES TO LEAVE ORDERS FOR BAGGAGE.—Millman's, cor. Main and North sts.; S. Seaman's, cor. Main and Clinton; Whitcomb House, Main st.; Erie R. R. Ticket Office, 4 State st.; G. W. Ticket Office, 95 Waverley Block; Canada Southern R. R., 100 Railroad av.; L. S. Ticket Office, 88 Mill st.; Wood's Hotel, N. Fitzhugh st.

Please Hold checks on N. Y. C. R. R. until you get to either end of the Depot, where you will find PRATT & WEED'S Agents, who are always ready to wait on you. **PRATT & WEED.**

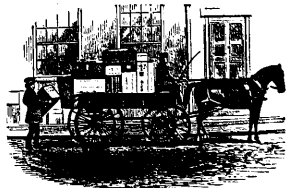

WM. H. HAHLE,
COACH PAINTER
 —AND—
CARRIAGE MAKER.

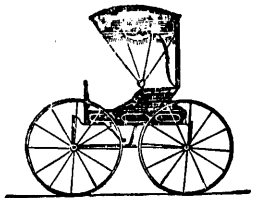

All descriptions of Light and Heavy Carriages built at this Establishment. We make a Specialty of Express Wagons.

Shop, No. 109 Pinnacle Avenue,
 ROCHESTER, N. Y.

F. A. LEE,
TRANSFER AND GENERAL FREIGHT DELIVERER.

Special Attention given to the moving of

Safes, Heavy Machinery and Household Furniture.

Goods delivered from the several Railroads, promptly on arrival. Orders left or addressed to Erie Office.

No. 4 STATE STREET or to 58 PLATT STREET,
Will receive Prompt Attention.

JAMES MELVIN,
HORSE SHOEING

And **BLACKSMITH JOBBING.**

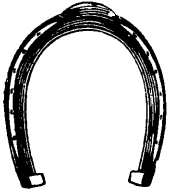

Mr. MELVIN has resumed business at his Old Stand,

No. 4 South Washington Street,

Where he will give his personal attention to **HORSE SHOEING,** and guarantees the satisfaction of other years.

EDWARD TOBIN,
COACH IRONING,

AND ALL KINDS OF

CARRIAGE WORK,

4 Ely Street, near S. St. Paul,

ROCHESTER, N. Y.

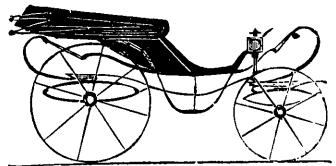

A. V. SMITH & CO.,

Manufacturers and Dealers in

FINE

HARNESS, CARRIAGES,
TRUNKS and SATCHELS,

65 and 67 State Street,

A. V. SMITH.

ROCHESTER, N. Y.

C. H. GIFFORD.

FRANK X. MASSETH, CARRIAGE STABLE,

15 North Fitzhugh St., Rochester, N. Y.

New Building, Erected 1876.

Stylish Open and Close Carriages,
Beautiful Clarence Coaches,
New and Elegant Landaus,

For WEDDINGS, PARTIES, FUNERALS, &c.

Several New Buggies Added for 1875-6

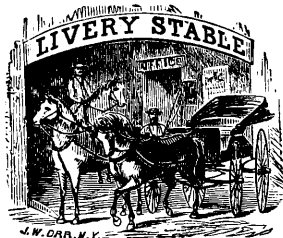
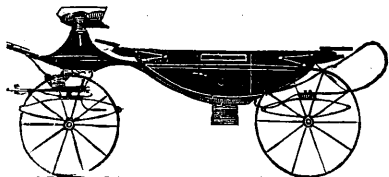

OPEN OR CLOSED

CARRYALLS

Supplied for Pleasure Parties.

Office Open Night and Day.

J. H. McDONOUGH,

MANUFACTURER OF

Carriages and Sleighs.

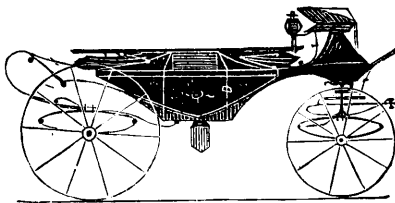

FACTORY AND OFFICE :

North Water, Corner Mortimer Street,
ROCHESTER, N. Y.

I am manufacturing all the different styles of PUBLIC OR PRIVATE CARRIAGES now in use. I am manufacturing **CHAMBERLIN'S PATENT SIDE SPAR BUGGY**, the best improvement ever made in side springs. Also, Light Road Wagons and Trotting Vehicles.

S. B. ROBY & CO.,

Wholesale Dealers in

SADDLERY and COACH

HARDWARE

IRON, STEEL, &C.,

No. 80 State St., and 41, 43 & 47 Mill St.,

S. B. ROBY. }
H. W. CARY. }

ROCHESTER, N. Y.

WM. CORRIS & CO.,

Sole Manufacturers of Corris' Patent

CARRIAGE WHEELS

(WM. CORRIS' PATENT, JAN. 6TH, 1874.)

Bent Felloes, Shafts, Poles, &c.,

TOP BOWS, TURNED SPOKES, HUBS.

Elizabeth Street, corner West Main Street,

ROCHESTER, N. Y.

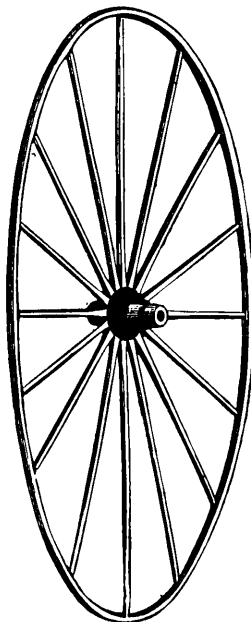
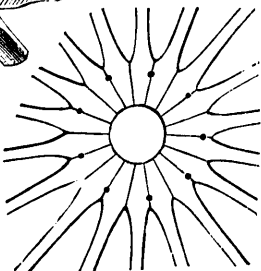
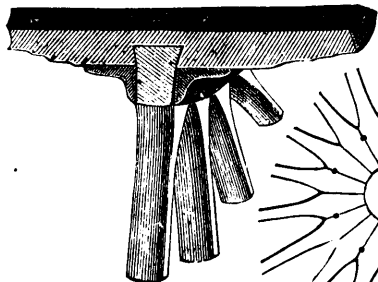

JOHN H. FRICK, LIVERY, BOARDING and HACK STABLE

HACKS
FOR
Wedding Parties.

BUGGIES
AND
SLEIGHS,
AT REASONABLE PRICES.

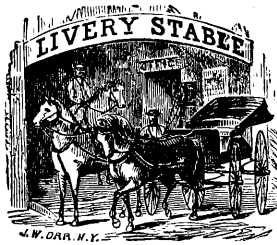

CARRYALLS
FOR
PIC-NICS
AND
PRIVATE PARTIES.

Orders Always Promptly
Attended to.

Nos. 47 and 49 S. St. Paul Street, Rochester, N. Y.

CHARLES V. JEFFREYS, Sexton & Undertaker, No. 125 STATE STREET,

Residence, 46 JAY STREET, north end of KENT STREET,
ROCHESTER, N. Y.

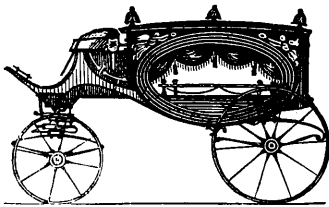

Keeps constantly on hand a large supply of Rose-wood, Black Walnut, and cheap Coffins and Caskets, Shrouds of all kinds, Coffin Plates, and everything to make his establishment complete. Hearses and Carriages furnished.

Agent for THE STEIN CASKET.
Office open at all hours, day and night.

ROCHESTER AXLE COMPANY,

Manufacturers of all kinds of

CARRIAGE AXLES,

Office and Factory,
Removed to 154 North Water St.,

(NEAR RAILROAD),
ROCHESTER, N. Y.

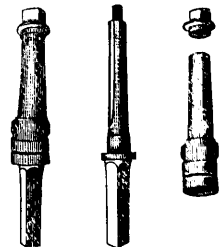

J. H. SPERRY, - Proprietor.

Empire Moulding Works,

AND

Picture Frame Manufactory

Picture Frames, Cornices
and Room

MOULDINGS.

GEO. H. NEWELL, Prop'r,

39 CORHAM ST.,

Rochester, N. Y.

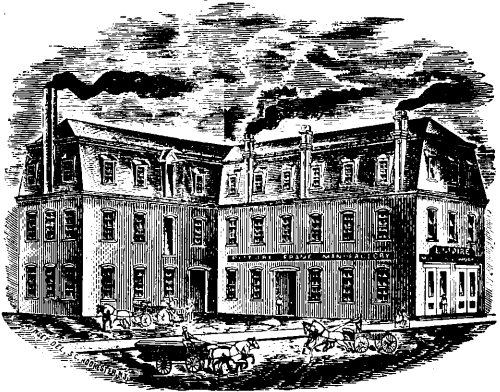

EAST SIDE HARNESS STORE

G. B. PAGE & SON,

98 E. Main St.

FINE HARNESS

A SPECIALTY.

RIDING SADDLES, &c.

Collars at Wholesale.

TRUNKS AND BAGS,

*Horse Furnishing Goods,
Lap Robes, Boots, &c.*

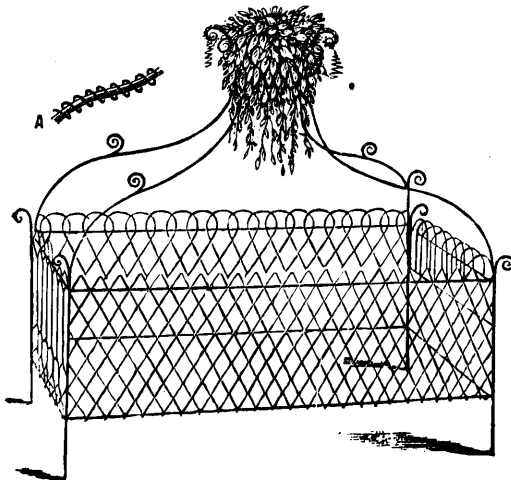
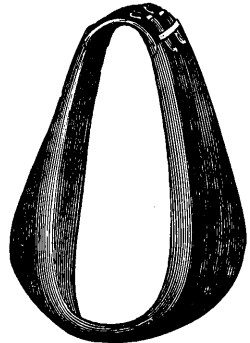
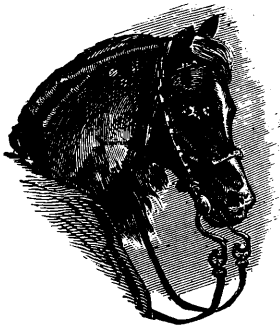

EXCELSIOR WIRE WORKS.

J. HADDLETON,

MANUFACTURER OF

Every Description of

WIRE GOODS,

FOR CEMETERY PURPOSES.

Chairs and Settees,

89 STATE ST.,

UP STAIRS. Rochester, N. Y.

Jas. Cunningham & Son,

Established 1838.

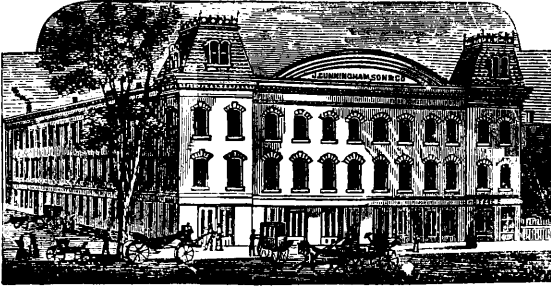

MANUFACTURERS OF

Clarences, Landaus, Family Carriages,

— AND —

Light Work of all Descriptions.

Hearses a Specialty.

No. 3 Canal Street, - Rochester, N. Y.

All Modern Styles Carriages Constantly on hand, or Made to Order on shortest possible notice.

ALL WORK WARRANTED.

Prices as low as any in the United States.

REPOSITORIES.

ROCHESTER, N. Y.

LOCKPORT, N. Y.

CHICAGO, ILL.

MEMPHIS, TENN.

NASHVILLE, TENN.

LOUISVILLE, KY.

NEW ORLEANS, LA.

TOPEKA, KANSAS.

DENVER, COL.

SAN FRANCISCO, CAL.

JOHN SOUTHALL.

CHAS. S. COOK.

SOUTHALL & COOK,
FURNISHING
UNDERTAKERS,
116 Front Street,
ROCHESTER, N. Y.

OPEN DAY AND NIGHT.



WHOLESALE DEALERS IN

UNDERTAKERS' TRIMMINGS,

AND MANUFACTURERS OF

Robes, Head-Linings, &c.

—♦♦♦—
BERRY BROTHERS,

MANUFACTURERS OF

VARNISHES,

DETROIT, MICH.

Rochester Office, 116 Front Street,

Represented by SOUTHALL & COOK.

HUNN, SPENCER & CO.,

Manufacturers of and Wholesale and Retail Dealers in

FURNITURE

CORNICES, MIRRORS,

Lambrequins, Curtains, &c.

ALSO,

Spring Beds, Mattresses,

BOLSTERS AND PILLOWS.

OFFICE and WAREROOMS:

Nos. 74 and 76 State Street, and

33, 35, 37, 39, 41, 43 and 47 Mill Street,

Factory, Jay Street,

ROCHESTER, N. Y.

CHAS. J. HAYDEN & CO.,

Manufacturers, Wholesale and Retail Dealers in

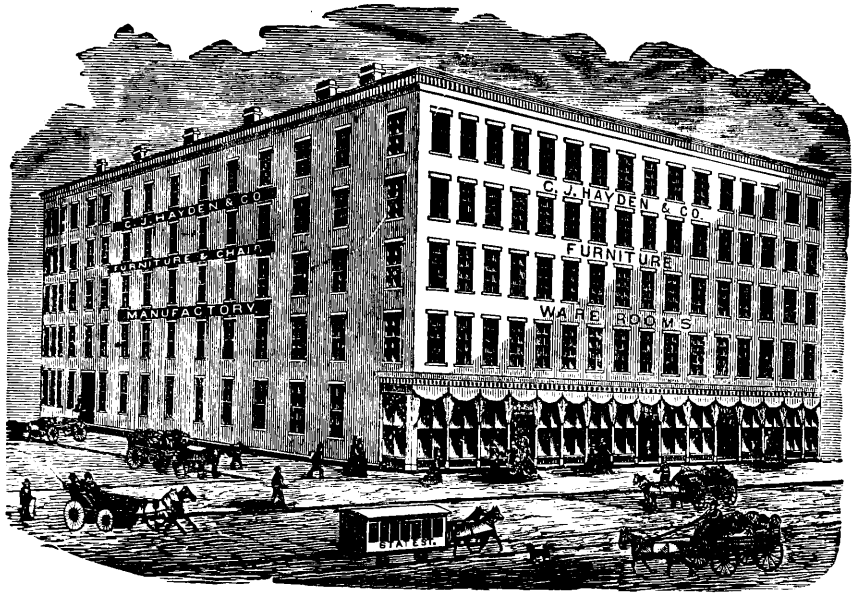

Chairs, Cabinet Ware AND Bedsteads.

Orders from the Trade Solicited and Promptly Attended to.

WHOLESALE WAREROOMS AND OFFICE,

180, 182, 184 and 186 State Street,

Near New York Central Railroad Depot,

ROCHESTER, N. Y.

DUNHAM & CO.,

MANUFACTURERS OF

Black Walnut Cane Seat

CHAIRS,

ALL GRADES.

Wholesale Dealers are invited to call at our new location,

No. 117 N. Water Street, near Andrews St. Bridge, Rochester, N. Y.

Co-Operative Foundry Comp'y,

MANUFACTURERS OF THE CELEBRATED

"CROWN JEWEL,"

AND A COMPLETE LINE OF
STOVES, HOLLOW-WARE,

Caldron Kettles, Vases, Fountains, Etc.

N. BRAYER, President. E. W. PECK, Sec'y and Treas.

8 to 14 HILL STREET, Rochester, N. Y.

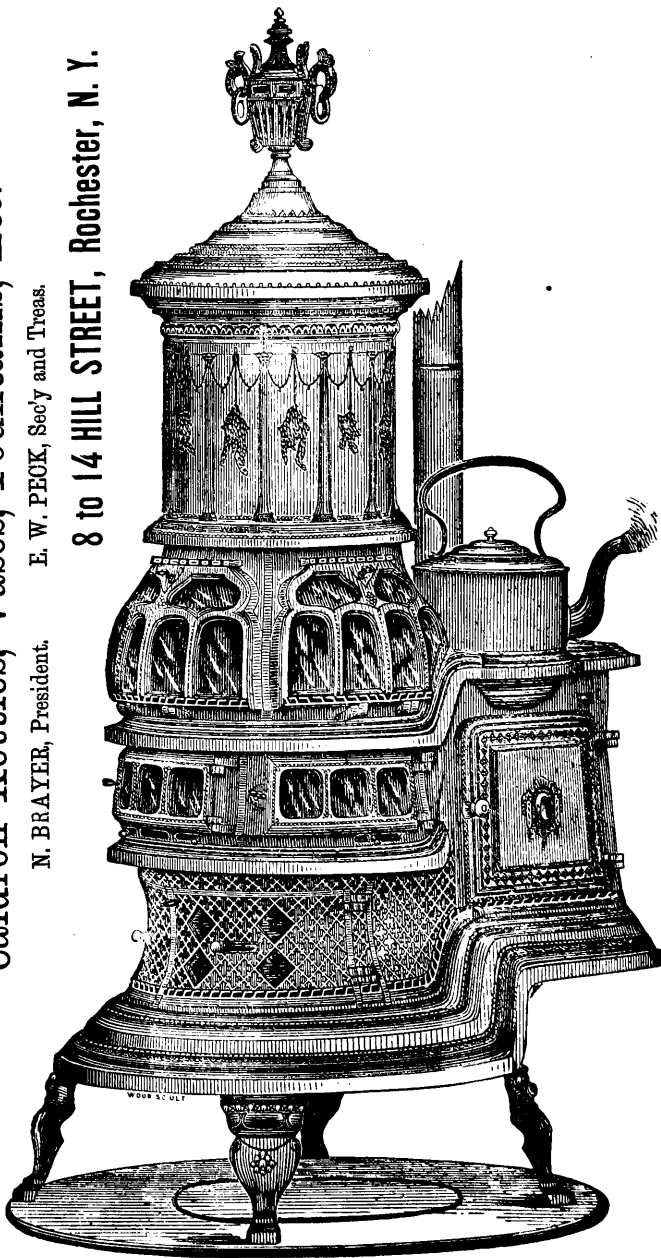

Sill Stove Company,

Manufacturers of the Celebrated

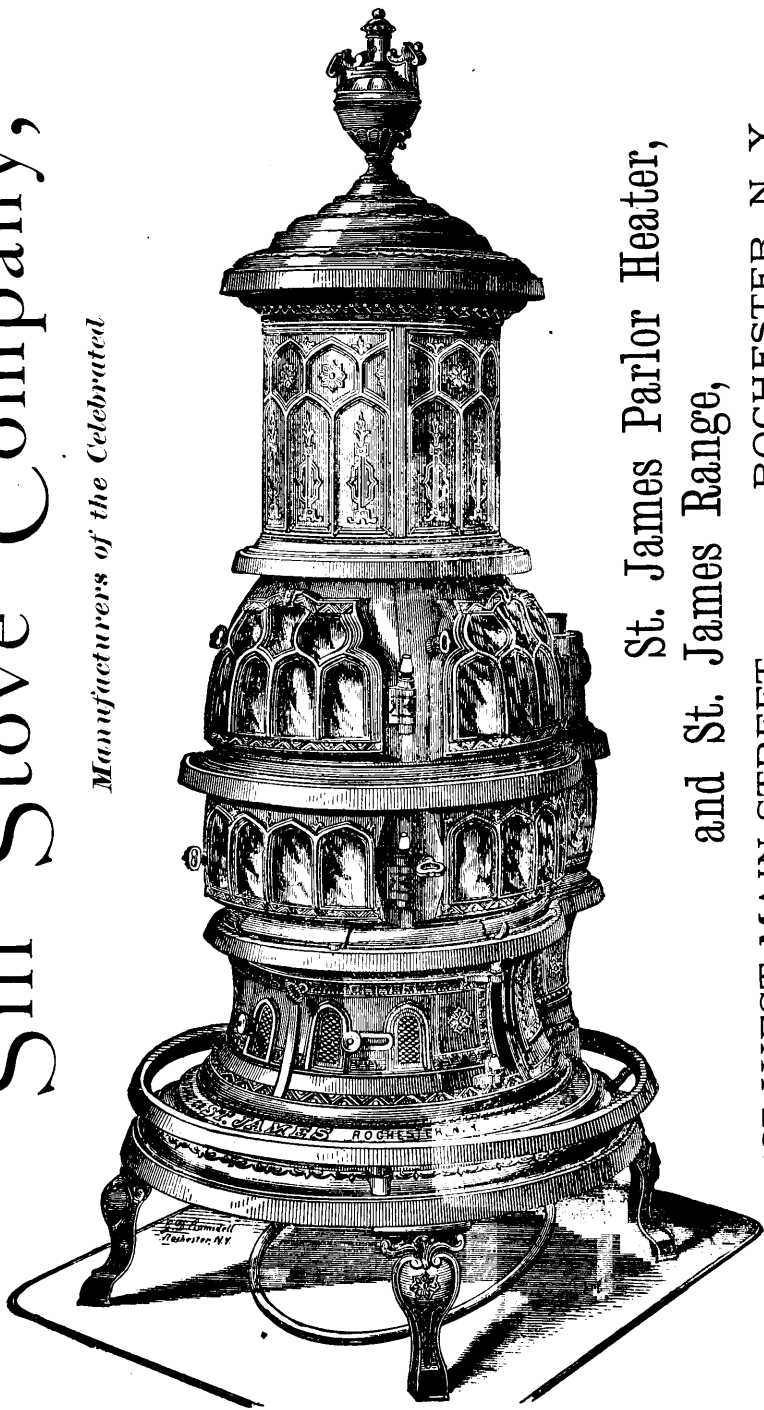

St. James Parlor Heater,
and St. James Range,
187 WEST MAIN STREET, - ROCHESTER, N. Y.

THE DOUBLE TURRETED Monitor Hygiene Furnace,

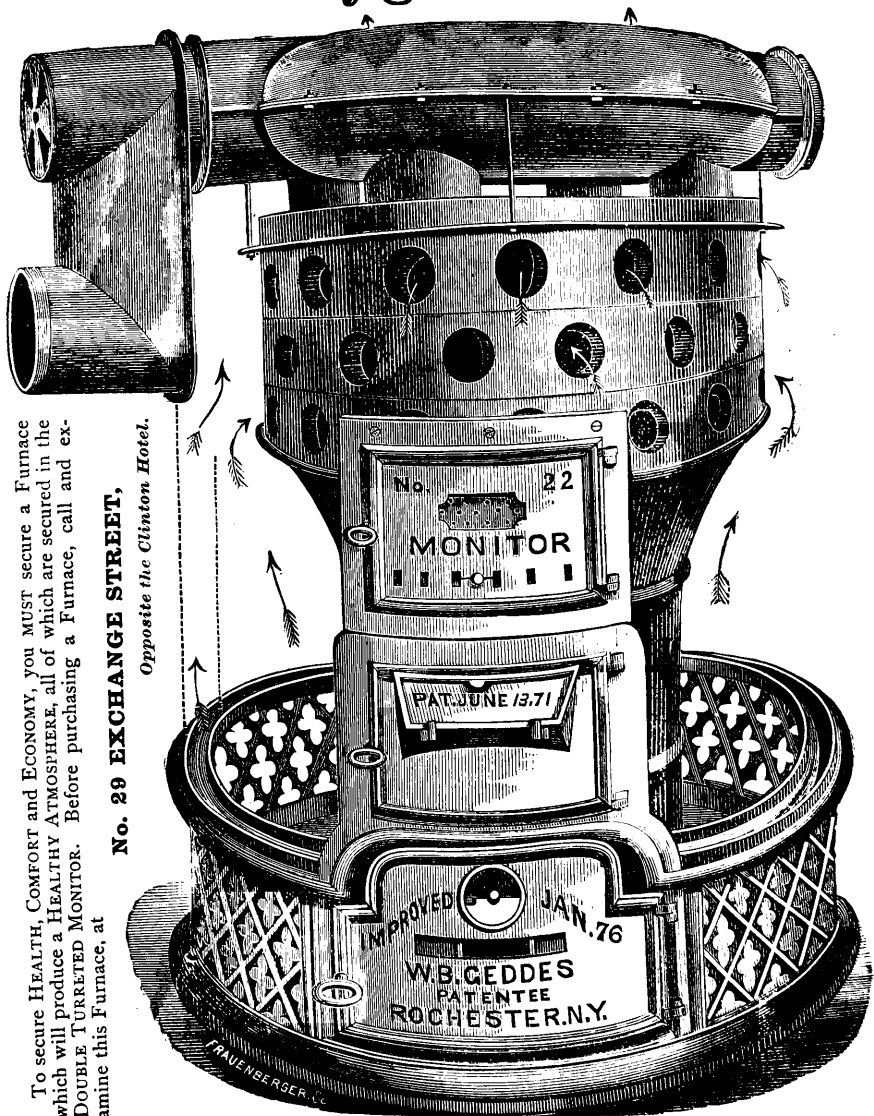

To secure HEALTH, COMFORT and ECONOMY, you MUST secure a Furnace which will produce a HEALTHY ATMOSPHERE, all of which are secured in the DOUBLE TURRETED MONITOR. Before purchasing a Furnace, call and examine this Furnace, at

No. 29 EXCHANGE STREET,

Opposite the Clinton Hotel.

W. B. GEDDES,

Sole Manufacturer and Patentee,

No. 56 Magne Street, - - - Rochester, N. Y.
Headquarters and Salesroom, 29 Exchange Street,



GOMMENGINGER & CO.,

MANUFACTURERS OF

NEW IMPROVED

EUREKA

Hot Air Furnaces,

IRON ROOFING,

—AND—

GALVANIZED CORNICES

REGISTERS, VENTILATORS,

AND WORKERS IN

TIN, COPPER AND IRON,

Plumbing, & Plumbers' Goods,

48 Exchange St.,

ROCHESTER, N. Y.

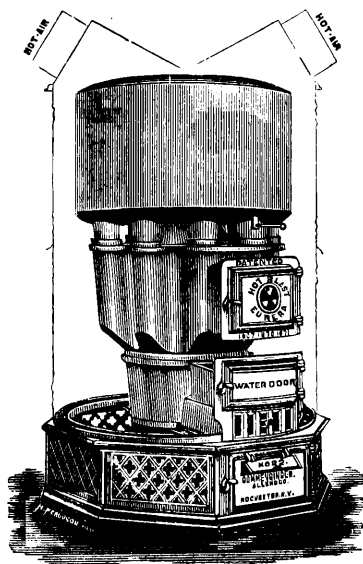

HOWE & CO.'S Rochester Scale Works,

MANUFACTURERS OF

U. S. STANDARD SCALES,

ALL KINDS OF

Counter,

Coal and

Portable,

Stock

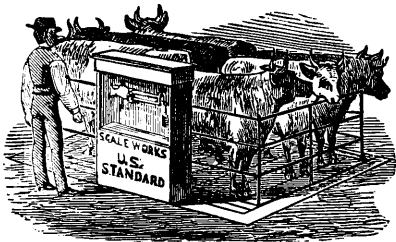

Hay,

Scales.

Office and Works, 3 Andrews St., - ROCHESTER, N. Y.,

Cor. Genesee River.

PARTICULAR ATTENTION PAID TO REPAIRS.

H. J. HOWE.

A. LEGGETT.

E. S. PHELPS & CO.,

Wholesale and Retail Dealers in

RIFLES, GUNS, PISTOLS,

Gun Materials, Ammunition,

FISHING TACKLE,

&c., &c.

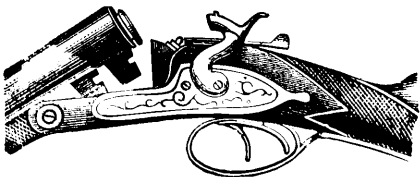

Sporting and Blasting Powder and Fuse.

WRINGERS REPAIRED.

4 E. MAIN ST..

- ROCHESTER, N. Y.

HOUSE FURNISHING GOODS.

Clothes Wringers,
Washing Machines,
Tubs, Pails,
Coal Hods,
Porcelain Kettles,
Fluting Irons,
Griddle Lifters,
Flour Sieves,
Clothes Bars,
Frying Pans,
Pots, Kettles and Spiders,

Stoves,
Tin Ware,
Kedzie Water Filters,
Knives and Forks,
Scissors,
Flat Irons,
Plated Castors,
Clocks,
Albata Spoons,
Silver Plated Spoons,
German Silver Spoons,

Crockery,
Tea Cups and Saucers,
Chopping Bowls,
Chopping Knives,
Copper and Tin Boilers,
Copper and Tin Kettles,
Chairs,
Tables,
Bedsteads,
Brackets for Clock Shelves
Spades.

CLOTHES WRINGERS AND FURNITURE REPAIRED.

Ask for Anything You Wish, and it will be Furnished.

In addition to the above, a large variety of goods for sale upon the Installment plan of ONE DOLLAR PER WEEK and upwards, as it may suit the convenience of the purchasers. Write your orders on a postal card, which costs only one cent, and it will bring the agent to your door with samples from which you can select. All goods warranted of the best quality and cheap as the cheapest.

Address,

NOVELTY SUPPLY COMPANY,

No. 16 Madison Street, Rochester, N. Y.

J. H. YORK,

NEAT AND CHEAP

CITY SCAVENGER

RESIDENCE,

No. 22 Gregory Street,

ALL ORDERS LEFT AT

MILLMAN'S SALOON, COR. OF NORTH AND EAST MAIN STREETS,

Will be attended to with neatness and dispatch, and at most

REASONABLE TERMS.

BARTH & ZEISLEIN,

MANUFACTURERS OF

FINE FURNITURE,

Barber and Dental Chairs,

69, 71 & 73 NORTH ST. PAUL STREET,

ROCHESTER, N. Y.

A. VETTER.

G. BOCK.

A. VETTER & CO.,

MANUFACTURERS OF

FINE FURNITURE

—AND—

General Cabinet Makers,

MAKE A SPECIALTY OF THE BETTER
CLASS OF WORK.

Shop, 149 North Water Street,

Corner River Street,

ROCHESTER, N. Y.

STEIN SHOW CASE WORKS.

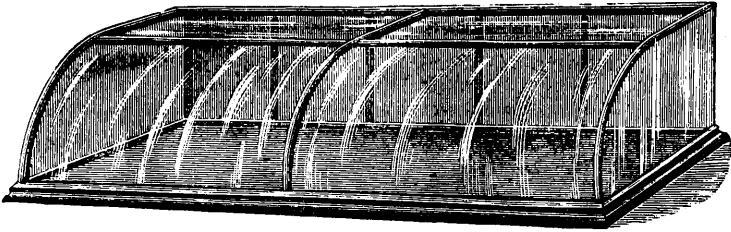

WOOD and METAL **SHOW CASES,**

AND

THE STEIN PATENT AQUARIUM.

The Celebrated Pat. Sliding Doors used on all Metal Cases.

JEWELERS' TRAYS Constantly ON HAND.

Cor. COURT and EXCHANGE STREETS, Rochester, N. Y.

GEO. W. ARCHER,

(Successor to R. W. Archer & Bro.),

Manufacturer of

Dental and Barber

CHAIRS,

DENTAL FURNITURE,

SURGEON CHAIRS,

Piano Stools,

&c., &c.

Send for Descriptive Price List, to

5, 7 and 9

NORTH WATER STREET,

Rochester, N. Y.

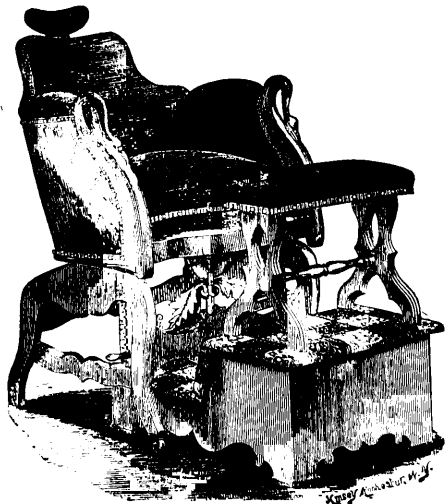

ARCHER'S PATENT.

Adjustable Barber's Chair, No. 2.

SCHANTZ, MINGES, SHALE & CO.,

MANUFACTURERS

OFFICE AND WAREROOMS,

Nos. 15, 17, & 19 North Water Street,



MANUFACTORY,
131, 133, 135, 137, 139 & 141 North Water Street,
ROCHESTER, N. Y.

And Wholesale and Retail Dealers in

FURNITURE.

E. VEYHL.

F. BARTHOLOMEW.

UPHOLSTERING.



R. E. SHERLOCK.

SAMUEL SLOAN.

SHERLOCK & SLOAN, GAS AND STEAM FITTING, AND PLUMBING,

No. 25 Exchange Street, Rochester, N. Y.

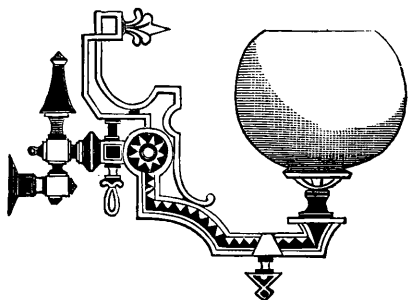

ON SALE,

GAS Fixtures.

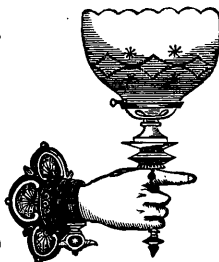

Patent Reflectors, for Windows, Churches and Public Halls,

Wrought Iron Pipe, Gas and Steam Fittings, Steam Pumps, Steam Gauges,
Water Gauges, Globe Valves, Angle Valves. In short, a full and large
assortment of all Goods used in the Trade, at Lowest Prices.

E. T. MILLER, PRACTICAL DECORATOR,

AND MANUFACTURER OF

WINDOW SHADES,

WHOLESALE AND RETAIL DEALER IN

French and American

PAPER HANGINGS,

HOUSE, SIGN and FRESCO PAINTING,

No. 9 West Main Street, - Rochester, N. Y.

MICHELSEN & RUCKDESCHEL,

Manufacturers and Wholesale Dealers in

CABINET WARE, BEDSTEADS, &c.

MANUFACTORY,

Hydraulic Buildings, foot of Mill Street,

PAUL MICHELSEN.

ROCHESTER, N. Y.

F. RUCKDESCHEL.

Chamberlain & Mordoff,

WHOLESALE AND RETAIL DEALERS IN

SAGINAW PINE,

HEMLOCK, SHINGLES, LATH; PICKETS, ETC.

OFFICE, Corner State and Platt Streets,

Planing and Sawing Done to Order.

ROCHESTER, N. Y.

JAMES PAYNE,

MANUFACTURER OF

MOULDINGS,

PICTURE FRAMES, &c.

Manufactory, Over A. Roda's Carving Shop,

Entrance on River Street,

ROCHESTER, N. Y.

ORNAMENTAL PLASTER WORKS.

CHARLES G. BROTSCH,

DEALER IN

Statuary, Center Pieces & Plaster Moulds,

OF EVERY DESCRIPTION.

All kinds of Plain and Ornamental Plastering, Kalsomining, Whitening
and Tinting done in a Superior Manner.



No. 9 Andrews Street,

- ROCHESTER, N. Y.

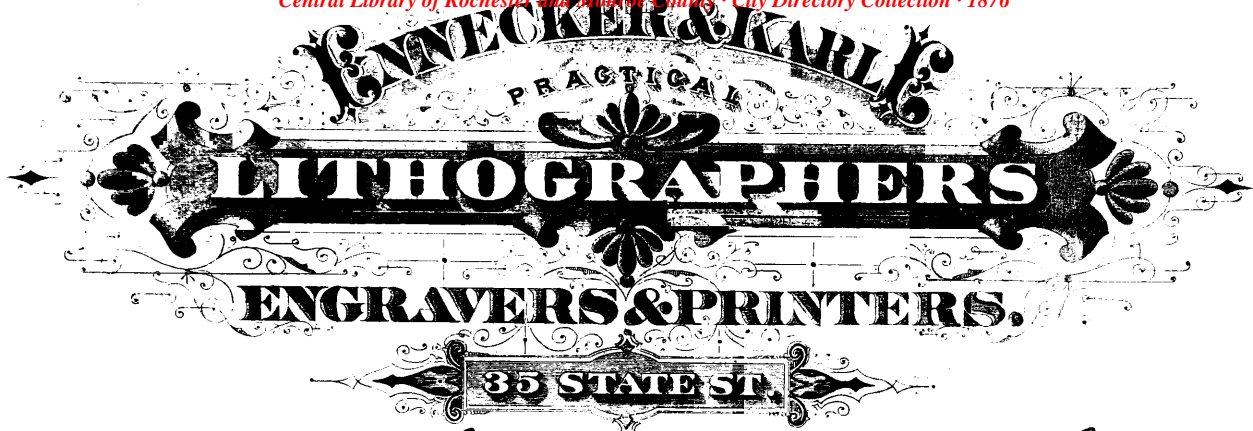
PENNECK & KARLE
 PRACTICAL
LITHOGRAPHERS
ENGRAVERS & PRINTERS.
35 STATE ST.

In order to meet the requirements of the general
 trade we have issued a new schedule of Reduced
Prices for all Lithographic work. — will furnish
 upon application samples of any style desired in
 Bill-Setting, Note-Heads, Checks, Drafts, Wrappers & other Labels
 Autograph Circulars, Business Cards, Invitations &c &c
 Rochester 1876. *Penneck & Karle*

C. H. MORSE,
STENCIL CUTTER,

MANUFACTURER AND DEALER IN

Stencil Materials, Baggage Checks,

STEEL DIES, RIBBON STAMPS, SEAL PRESSES, &c., &c.

EXCELSIOR LINEN MARKER,

The best thing out for Marking Clothing, Linen, Cards, Books, &c.

AGENTS WANTED.

69 STATE STREET, - - ROCHESTER, N. Y.

J. S. BEACH,

STEAM, GAS AND WATER FITTING,

J. S. BEACH'S PATENT

HYDRAULIC ELEVATOR.

Gas and Steam Fittings, Steam Pumps, Wrought-Iron
Pipe, Gauges, Valves, &c. Full assortment of
nice Goods at Lowest Prices.

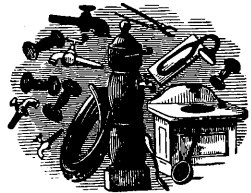

No. 17 Mill Street, - Rochester, N. Y.

GENESEE PAINT AND COLOR WORKS.



OIL MILL AND SASH FACTORY.

WOODBURY, MORSE & CO.,

(Successors to M. F. REYNOLDS & Co.)

Window, Sheet and Plate Glass, Painters'
and Artists' Materials,

Nos. 5 and 7 West Main Street, - - - Rochester, N. Y.

J. C. BARNARD,

WHOLESALE DEALER IN

PAINTS, OILS, VARNISHES,

Glass, Putty, Brushes, &c. Also,

ARTISTS' AND WAX FLOWER MATERIALS,

Nos. 23 and 25 FRONT STREET, - ROCHESTER, Y. Y.

C. W. TROTTER.

GEO. STONE.

TROTTER & STONE,
DEALERS IN
FURNACES, RANGES,
Tinware, Etc.,

Particular Attention Given to Putting in Furnaces,

No. 29 Exchange Street, - Rochester, N. Y.

WATERS'
Improved Tree Pruner



Is indispensable for pruning from the tallest Fruit, Street or Lawn Trees, to the smallest Shrub or Berry Plant, which more than ten thousand that have used the same can testify to.

AGENTS WANTED.

E. S. LEE & CO., - Proprietors,
19 Warehouse St., Rochester, N. Y.

83 EXCHANGE 83
STREET.

JAMES CAMPBELL,

(Successor to PERCY & CAMPBELL,
77 STATE STREET),

DEALER IN

STOVES,
RANGES,
FURNACES,
REFRIGERATORS,
ICE BOXES,
AND
HOUSEHOLD GOODS.

Agent for

BLODGETT & SWEET'S

PORTABLE OVEN,

PAYNE'S

Portable and Stationary Engines.

WESTCOTT & HOUSTON,

DEALERS IN

Stoves, Furnaces, Ranges.

PARTICULAR ATTENTION PAID TO HEAVY SHEET IRON WORK.

WALSH, WESTCOTT & CO.,

Practical Plumbers AND Gas Fitters,

No. 196 STATE STREET,

ALL WORK WARRANTED.

ROCHESTER, N. Y.

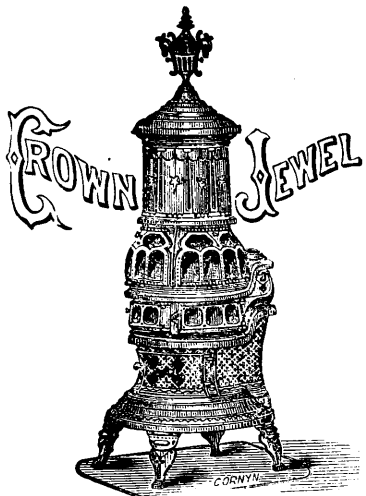

STOVES,
Of Every Price and Description,

—AT—
HINMAN'S,

16 S. St. Paul Street, - Rochester, N. Y.

Will Exchange for any Stoves. Makes a Specialty of Second-Hand Stoves; and sells on the Installment Plan.

CHAS. F. SCHLEGEL,

DEALER IN

Stoves, Tinware

—AND—

HOUSE FURNISHING GOODS.

Also, makes a Specialty of

TIN ROOFING,

Gutters, Etc.

Tin, Copper and Sheet Iron Work.

No. 92 St. Joseph Street,

Near Kelly Street. ROCHESTER, N. Y.

B. DEIGERT,

DEALER IN

STOVES and TINWARE,

97 St. Joseph Street, Rochester, N. Y.

Special Attention paid to Tin Roofing, Gutters and Conductor Pipe.

ALL WORK WARRANTED.

ESTABLISHED 1878.

H. R. KENNEDY,

(Successor to Hoxie & Kennedy),

PRACTICAL TINNER,

AND DEALER IN

Stoves, Tin, Copper and Sheet Iron Ware, Nails, Pumps, Lead Pipe, Sinks, Hollow Ware, House Furnishing Goods, Agricultural Implements, &c.

Agent for the Celebrated ALDEN PATENT HORSE HOES and CULTIVATORS.

Cash Paid for Rags, Old Copper, and All Kinds of Metals.

ROOFING, JOBBING, GUTTERS, AND HOUSE WORK
A SPECIALTY.

No. 100 South Avenue, - - Rochester, N. Y.

HOWE & ROGERS,

Importers and Dealers in

CARPETS, OIL CLOTHS,

MATTING, MATS, &c., &c.

Best Selected Stock in the State.

37 STATE STREET,

J. H. HOWE,
C. ROGERS.

ROCHESTER, N. Y.

J. O'DONOUGHUE & CO.,

Manufacturers of all kinds of

MATTRESSES

BEDDING AND COUCHES,

And General Dealers in

Furniture, Carpets, Table and Floor Oil Cloths,

LIVE GEESE FEATHERS, &c.

J. O'DONOUGHUE,
THOS. B. McKENNA. }

42 East Main Street, ROCHESTER, N. Y.

CHAS. HARLFINGER,

UPHOLSTERER,

129 North Clinton Street, - Rochester, N. Y.

ALL KINDS OF

FURNITURE

MADE TO ORDER and REPAIRED in the best workmanlike manner. MATTRESSES REPAIRED and new ones MADE TO ORDER. Also,

The Latest Styles of LAMBREQUINS Made to Order.

DANIEL SCANLIN'S

CASH

CROCKERY STORE,

68 West Main St., Powers' Block,

Is the Headquarters for

CROCKERY, CHINA AND GLASSWARE,

Kerosene Lamps, Chandeliers, etc.

ALBERT SCHIFFNER,
Upholsterer and Decorator,

50 EAST MAIN STREET,

Keeps constantly on hand

FINE FURNITURE,

Make a specialty of

Lambrequins, Window Decorations, Draperies, etc.

UPHOLSTERY WORK REPAIRED IN THE BEST MANNER.

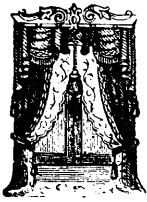

JOHN B. WEGMAN & CO.,

Manufacturers and Dealers in

FURNITURE

Mattresses, Beds, &c.,

44 EAST MAIN STREET, - ROCHESTER, N. Y.

A. G. IRVING,

FURNITURE REPAIRER,

Old Furniture Repaired and Refinished.

(Work done at the house where practicable.)

ALSO

PRACTICAL CARVER,

Fancy and Bracket Carving.

Corner East Main and North Water Streets,
Over Hulbert's Shoe Store, - ROCHESTER, N. Y.

Orders by Mail solicited and promptly attended to.

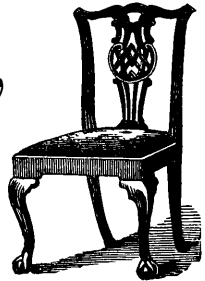

G. S. BURLEY.

I. H. DEWEY.

BURLEY & DEWEY,

Manufacturers, Wholesale and Retail Dealers in

FURNITURE OF ALL KINDS.

88 State Street and 51 Mill Street.



UPHOLSTERED GOODS A SPECIALTY.

HAMILTON & MATHEWS,

WHOLESALE DEALERS IN

HARDWARE AND CUTLERY,

FILES, BELTING, MECHANICS' TOOLS,

TIN PLATE, TINNERS' STOCK, METALS, &c.

21 and 23 WEST MAIN STREET.

Will REMOVE January 1st, 1877, to our New Store, No. 27 Exchange Street.

LOUIS ERNST,

DEALER IN

Mechanics' Tools, Builders' Hardware,

Moulders', Machinists' and ADDIS' Carving Tools,

AGRICULTURAL IMPLEMENTS, &c.

Democrat Building, D. R. Barton's Old Stand, No. 3 W. Main Street,
ROCHESTER, N. Y.

F. SEIFRIED & CO.,

DEALERS IN

BUILDERS' GOODS, HARDWARE

Belting, Lace Leather, Etc.,

Table and Pocket Cutlery, Mechanics' Tools, Agricultural Implements,

13 WEST MAIN STREET,

F. SEIFRIED, }
C. W. KENNING, }

Rochester, N. Y.

J. S. DISBROW,

MANUFACTURER OF ALL KINDS OF

WOOD

PACKING BOXES

SHOE CASES, FRUIT CRATES, &c., &c.

A specialty made of Patent Dove-tailed work, in Soft or Hard Wood, for Seed, Baking Powder or other fancy boxes.

UNEQUALLED FACILITIES. CENTRAL LOCATION. LOW PRICES.

Factory, No. 3 Aqueduct Street, Rochester, N. Y.

ESTABLISHED 1838.

WM. BURKE & CO.,

Wholesale and Retail Dealers in

IRON, STEEL,

**Nails, Spike, Builders', Coach and General Hardware,
Jewell & Son's Leather Belting.**

12 West Main Street, Rochester, N. Y.

WM. BURKE.

NEWELL A. STONE.

WM. B. BURKE.

SWIFT & GORDINIER,

DEALERS IN

Builders' Hardware, Iron,

MECHANICS' TOOLS,

AGRICULTURAL IMPLEMENTS.

LEWIS SWIFT, }
E. D. GORDINIER. }

335 State Street, Rochester, N. Y.

—♦—
Hoop and Band Iron a Specialty.

POLLOCK, WEAVER & CO.,

WHOLESALE HARDWARE

Agricultural Tools, Belting, &c.,

METALS, TINNERS' STOCK AND TRIMMINGS.

J. B. POLLOCK, }
C. F. WEAVER, }

ROCHESTER, N. Y.

{ R. M. WEAVER,
JOHN W. GOSS.

H. A. KINGSLEY.

H. H. HOWARD.

H. JACKSON.

H. A. KINGSLEY & CO.,

Dealers in

HARDWARE

Farming and Agricultural Implements, Builders' and Contractors' Hardware, Fluting Machines, Table and Pocket Cutlery,
Boston Copper Weather Vanes.

112 East Main Street, Whitcomb House Block, - Rochester, N. Y.

Agents for CHAMPION FEED CUTTER.

J. G. WAGNER,
CONTRACTOR,
FOR BUILDINGS,

All kinds of **CARPENTER** and **MASON WORK DONE PROMPTLY.**

Refers to the Carpenter Work of Powers' Buildings and First Baptist Church.

Shop, No. 14 St. Joseph Street,

Residence, 53 Atwater Street,

ROCHESTER, N. Y.

FRANK MILES,
CONTRACTOR AND BUILDER.
Carpenter Work of Every Description.

—→
STORE FITTING AT SHORT NOTICE.
←—

Shop, Minerva Alley,

Rochester, N. Y.

Address, 197 POWERS' BUILDINGS.

GEO. W. ALDRIDGE,
Carpenter and Builder,

OFFICE, No. 51 POWERS' BUILDING,

SHOP, No. 97 EXCHANGE STREET,

ROCHESTER, N. Y.

Contracts taken for building Stores, Churches, School Houses,
Dwellings, &c., in Rochester, N. Y.

J. STEPHANY,
CONTRACTOR AND BUILDER,

All descriptions of Buildings erected at short notice.

STORE AND HOUSE JOBBING.

Shop, Holland, near Nassau St.

Residence, 54 Nassau Street.

ROCHESTER, N. Y.

JOHN W. McELHINNY,
BUILDER AND CONTRACTOR,

OFFICE AT RESIDENCE,

47 Chestnut Street, Rochester, N. Y.

ADAM FREIDRICH,
MASON AND BUILDER,

Every description of MASON WORK done with Promptness
and Dispatch, on Reasonable Terms. Also,

BRICKLAYING, PLASTERING, TUCKING, &c.

No. 27 Baden Street, Rochester, N. Y.

STALLMAN BROS.,
CONTRACTORS,

AND JOBBERS OF ALL KINDS OF

MASON WORK.

Jobbing and Repairing Promptly Attended to.

HENRY STALLMAN,
251 North St. Paul Sreet.

FRED. P. STALLMAN,
78 Cady Street.

F. J. MAUDER,
CARPENTER AND BUILDER
AND
CONTRACTOR.

ESTIMATES FURNISHED PROMPTLY.

Residence, Oakman Street,

Cor. Galusha Street, - - ROCHESTER, N. Y.

**WILLIAM H. MARSON,
CARPENTER AND CONTRACTOR,**

Jobbing promptly attended to.

CISTERNS BUILT TO ORDER.

No. 5 SPRING ST. Corner of PINE STREET,
ROCHESTER, N. Y.

GEO. L. MAXON,

MASON AND CONTRACTOR.

ALL DESCRIPTIONS OF

Mason Work done at short Notice,

JOBGING A SPECIALTY.

Address at Residence, No. 10 Tremont place, off 45 Tremont Street,
ROCHESTER, N. Y.

**WM. SAUNDERS,
CARPENTER & BUILDER,**

Rear 34 N. Washington Street and Scott Alley,

ROCHESTER, N. Y.

Stores Fitted and Repaired on Short Notice.

**WILLIAM TANNER,
Practical Joiner and Builder,**

Rear 196 West Main St., ROCHESTER, N. Y.

ALL ORDERS AND JOBBING WORK PROMPTLY ATTENDED TO. CISTERNS MADE TO ORDER.

Residence, No. 56 Atkinson St.

H. D. PARKER,
BUILDER, CARPENTER & CONTRACTOR.

STORE FITTING AND JOBBING.

Shop, No. 55 Griffith Street,

ADDRESS ALL ORDERS TO

No. 63 Broadway, ROCHESTER, N. Y.

J. B. WARE,
BUILDER AND CONTRACTOR.

Contracts for the entire completion of Buildings, such as

STORES, CHURCHES, DWELLINGS, ETC.

Shop, 40 Fulton Avenue (formerly Varnum St.) opposite Bloss,

ROCHESTER, N. Y.

Fancy Front Doors.

Cisterns Made to Order.

WILLIAM RICHARDS,
CONTRACTOR AND BUILDER.

Stair Building and Hand Railing

Will receive particular attention.

Repairing and Jobbing promptly attended to, and neatly executed, at Reasonable Rates. Address at Residence,

Myrtle, near Lyell Street, Rochester, N. Y.

Orders may be left at J. C. Miller & Son's, 39 Powers' Buildings.

Blinds.

Painting.

THOMAS SALTER,

PRACTICAL

JOINER AND BUILDER,

148 PLYMOUTH AVE., ROCHESTER, N. Y.

Jobbing Promptly attended to, and Cisterns made to order.

P. & W. WAGNER,
AGENTS,
BUILDERS AND CONTRACTORS,
59 Asylum Street,
ROCHESTER, N. Y.

Estimates given on Contracts at short notice. STAIR BUILDING in all its branches.
 CISTERNS made to Order. JOBBING promptly attended to.

GEORGE H. THOMPSON & CO.
RAILROAD
CONTRACTORS AND BUILDERS.
 BUILDINGS OF EVERY DESCRIPTION
 Estimated upon and Contracts taken.
 Railroad and Road Grading and Masonry Done.
OFFICE, EAST MAIN STREET,
 Corner North, - - - ROCHESTER, N. Y.

H. H. HOWARD,
BUILDER AND CONTRACTOR,
Office, 112 EAST MAIN STREET,
 (WITH H. A. KINGSLEY & Co.)
 ROCHESTER, N. Y.

JOHN LUTHER,
Builder and Contractor,
REAR 54 NORTH STREET,
ROCHESTER, N. Y.

Estimates Given on Contracts at Short Notice.

OFFICE, with Geo. H. Thompson & Co., North corner East Main Street.

G. W. & C. T. CROUCH, STEAM SAW MILL,

And Manufacturers of all kinds of

Lumber, Shingles and Lath.

*Also, Lumber Sawed to Order. All kinds of DRY LUMBER and
HARD AND SOFT WOOD.*

SOUTH ST. PAUL ST., cor. Griffith, Junction Erie Canal and Feeder.

CRAIG & CROUCHS,

Wholesale and Retail Dealers in all kinds of

Pine, Hemlock, Hard Wood Lumber,

LATH, SHINGLES, FLOORING, CEILING, FENCE POSTS & PICKETS.

All kinds of PLANING and RE-SAWING done to order, at our NEW PLANING
MILL, located in Yard.

Yard and Mills, cor. South St. Paul and Griffith Streets.

HENRY H. CRAIG,
G. W. & C. T. CROUCH, }

Rochester, N. Y.

H. H. EDGERTON,

DEALER IN ALL KINDS OF

PINE AND HEMLOCK LUMBER

SHINGLES, LATH AND FENCE POSTS,

PLANING AND SAWING DONE TO ORDER.

Yard and Office, No. 207 South St. PAUL STREET, near Canal Bridge.

ROCHESTER, N. Y.

HENRY OBERLIES, Carpenter, Builder and Contractor,

CISTERNS MADE TO ORDER.

Store Fitting and Jobbing.

Shop, Grand Street, corner Bond, Rochester, N. Y.

HAHN, WEIS & CO.,
 MANUFACTURERS OF
BRICK AND TILE

Office, No. 52 South St. Paul Street,
Manufactory, Monroe Ave., beyond City Line,
 ROCHESTER, N. Y.

HOLLOWAY & NORMINGTON,
 DEALERS IN
Medina, Albion and Ohio Sand Stone,
 PLATFORM, FLAGGING, STEPS,

Door and Window Caps and Sills, and all kinds of CUT STONE. Particular attention
 given to Construction and Repairs of Sidewalks.

STONE YARD, West of West Main Street Bridge,

ISAAC HOLLOWAY.

ROCHESTER, N. Y.

MARK NORMINGTON.

ROCHESTER
Brick and Tile Manufacturing Co.

A LARGE QUANTITY OF

BUILDING BRICK and DRAIN TILE

Kept Constantly on Hand.

Office, 51 Powers' Buildings, Rochester, N. Y.

ROCHESTER
ADAMANTINE BRICK CO.,
 No. 5 MASONIC BLOCK,

Works, Genesee Street, near Rapids, - **ROCHESTER, N. Y.**

L. C. WOODRUFF, President.

GEO. E. FISHER, Treasurer.

BENNETT & BARRY,

WHOLESALE AND RETAIL DEALERS IN

PINE AND HEMLOCK LUMBER,

DRESSED AND UNDRESSED.

PLANING and SAWING done to Order. LATH, SHINGLES, POSTS, PICKETS, &c.

OFFICE and YARD:

Corner Lake Avenue and Champion Street,

ALBERT BENNETT, }
J. H. BARRY. }

ROCHESTER, N. Y.

HORCHELER & MILES,

MANUFACTURERS OF

SASH, DOORS, BLINDS, MOULDINGS,

And GLAZED WINDOWS.

☛ PINE KINDLING. ☚

BUTTS' BUILDING (known as the Beehive), AQUEDUCT STREET.

ROCHESTER, N. Y.

O'CONNOR & DEVEREAUX,

MANUFACTURERS OF

SASH, DOORS, BLINDS,

Mouldings, Window Frames, Door Frames and Casings,
Fancy Front and Store Doors.

☛ ORDERS by Mail Promptly Filled. ESTIMATES Furnished on Application. ☚

FOOT OF NORTH WATER STREET,

JOHN J. O'CONNOR, }
N. B. DEVEREAUX. }

ROCHESTER, N. Y.

EHRSTEIN BROS.,

Manufacturers and Dealers in

CUT STONE,

All kinds of Sandstone, Limestone, Albion, Medina and Brown Stone
for Building Purposes, constantly on hand, or cut to order.

CEMETERY WORK OF ALL DESCRIPTIONS.

☛ We give our personal supervision to all work. ☚

YARD AND OFFICE: OAK STREET, CORNER SMITH,

ROCHESTER, N. Y.

DOMINICK MURA, CONTRACTOR & BUILDER

SOLICITS ALL KINDS OF

House Building, Repairing, &c.

ALL CONTRACTS AND ORDERS FOR JOBBING PROMPTLY ATTENDED TO.
23 Gorham Street, Rochester, N. Y.

JOHN MAUDER, Builder, Contractor

AND DEALER IN

REAL ESTATE,

271 North Clinton Street, - - ROCHESTER, N. Y.

EDWARD DeJONGE.

ABRAHAM MARSIELJE.

DeJONGE & MARSIELJE,

Masons & Builders,

All kinds of STONE WORK, BRICK WORK, PLASTERING, CORNICES
and FINISHING, done to Order, and in a Thorough Manner.

34 BUCHAN PARK,

Or. 227 St. Joseph Street, - - ROCHESTER, N. Y.

GEORGE HALL, CONTRACTOR,

Carpenter and Builder,

Shop, Joiner cor. Kelly Street, - ROCHESTER, N. Y.

Contracts for the Building of Churches, Public Buildings, Stores, Dwellings, Etc.

THE *Dodge & Boyd*

GENERAL ENGRAVING AND LITHOGRAPHING ESTABLISHMENT

DESIGNING

12 MAIN STREET BRIDGE. ROCHESTER, N.Y.

WEDDING, RECEPTION
 AND
 PARTY INVITATIONS,
 CALLING CARDS,

Bank Drafts,
 Notes,
 Checks,
 Letter Heads,
 Bill Heads,
 Cards,
 Show Cards,



Monograms,
 Labels,
 Bonds,
 Portraits,
 Chromos,
 Maps,
 Seal Presses.

STENCIL PLATES.

Copper Plate Engraving a Specialty.

C. SIEBERT,
Carpenter & Builder

Will Estimate on Contracts in any part of the City.

105 Pinnacle Avenue, - Rochester, N. Y.

C. W. CASE,

CONTRACTOR, JOINER & BUILDER

Shop, 35 South Goodman Street,

Near Monroe Avenue.

ROCHESTER, N. Y.

AUGUST PAPPERT,

Contractor for all kinds of

MASON WORK,

110 Pinnacle Ave., - Rochester, N. Y.

PHILIP BLOCK,

Mason and Contractor

All kinds of Building Contracts executed in the Best Manner.

Address at Residence, - 111 South Avenue,

—OR—

52 SOUTH ST. PAUL STREET, - ROCHESTER, N. Y.

JACOB KARP & SONS, SLATE ROOFERS,

ROCHESTER, N. Y.

Slate Roofing Done Neatly on Short Notice and at Reasonable Terms.

SLATE FURNISHED, IF DESIRED, AT THE LOWEST MARKET PRICES.

Jobs Executed at any Distance.

Persons desiring their services will address them at

No. 26 and 39 RAUBER ST., Rochester, N. Y.

FELT, CEMENT, GRAVEL

—AND—

COMPOSITION ROOFING,

Executed on the Most Improved Principles.

Also, JOHN'S PATENT ASBESTOS ROOFING.

Old Roofs of every description Repaired with Improved Elastic Cement, and Warranted Tight.

Roofing Cement for Sale in any Quantity.

Iron Ore and Elastic Paint for Roofs.

References in all parts of the City. Country Orders Executed.

FRANK M. HOGLE, Practical Roofer,

39 Tyler Street, near Scio Street, Rochester, N. Y.

ROOFING.

ROBINSON'S

Three-ply Felt, Cement and Gravel Roofing,

ALSO,

AN A No. 1 CEMENT PAINT,

For Iron and Tin Roofs.

Office, 48 Exchange Street, - - ROCHESTER, N. Y.

JOHN G. HEATH,

PRACTICAL

MOVER OF BUILDINGS,

186 North St. Paul Street,

ROCHESTER, N. Y.

J. W. ARCHER,
CARPENTER and JOINER,
CISTERN BUILDER,
And manufacturer of all kinds of
TANKS AND IRON BOUND TUBS.

A full assortment kept constantly on hand and for Sale.

Shop 114 N. Water Street, near Andrew St. Bridge, Rochester, N. Y.

All kinds of **JOBING** promptly attended to with neatness and dispatch, and
on the **LOWEST POSSIBLE TERMS.**

G. E. SHERRY,
MANUFACTURER OF
ARTESIAN WELLS,
AND PATENTEE OF
WELL TOOLS.

Good Pure Water Guaranteed in any Locality or Soil.

Address, G. E. SHERRY,

No. 17 St. Joseph Street, - Rochester, N. Y.

JOHN B. GLEICHAUF,

MANUFACTURER OF

Well and Cistern Pumps.

CISTERN PUMPS AT WHOLESALE.

Manufactory, North Avenue, near Bay Street,

Warerooms, 37 Sanford Street, Rochester, N. Y.



Cisterns and Wells Cleaned, and Pumps Repaired at short notice.

R. BENNETT,
Steam, Gas & Water Fitter,
And **PRACTICAL PLUMBER,**

No. 8 Mumford Street, - Rochester, N. Y.

A LARGE STOCK OF GAS FIXTURES CONSTANTLY ON HAND.

ESTABLISHED, 1843.

FRANK VAN DOORN,

Has the best facilities for furnishing

SIGNS,

BANNERS, SABBATH SCHOOL SHIELDS,

RAISED LETTERS, GLASS SIGNS.

No. 74 Arcade, East Gallery, - - - Rochester, N. Y.

WORK SHIPPED EVERYWHERE.

A. ERNISSE & SON,

HOUSE PAINTERS,

CONTRACT FOR THE

Painting and Renovating of all Classes of Buildings.

OFFICE.

No. 88 Powers' Buildings, - - - Rochester, N. Y.

Shop, No. 237 East Main Street.

GEORGE ARNOLD,

SIGN,

Ornamental and Carriage Painter,

No. 109 STATE STREET,

ROCHESTER, N. Y.

E. A. BISHOP,

PRACTICAL

HOUSE AND SIGN

PAINTER AND GRAINER,

12 STONE STREET,

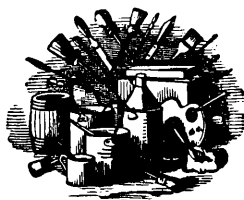



Whitening, Wall Tinting and Decorating.

ROCHESTER, N. Y.

H. LETTINGTON,
 MANUFACTURER OF
PAPER BOXES,

PLAIN AND FANCY, OF EVERY DESCRIPTION. ALSO,
 Grape, Druggists', Jewelers' and Merchants' Shelf Boxes, &c.,
 Dealer in Fancy Imported Paper Stock, Embossed, Gilt and Figured Papers of all kinds.
 Pictures and Ornaments, Bronze for Printers, &c.

 **BEST QUALITY OF PASTE FOR SALE.** 

Over 25 Exchange Place, cor. Front, Office, First Floor, ROCHESTER, N. Y.

STEAM PAPER BOX FACTORY.

J. K. BUNT,
 MANUFACTURER OF
PAPER BOXES,
 OF EVERY DESCRIPTION.

Shoe and Dry Goods Dealers' Shelf Boxes.

No. 91 North Water Street. ROCHESTER, N. Y.

H. D. SARGENT & CO.,
 MANUFACTURERS OF
Dress, Cloak and Passementerie Trimmings,
 CORDS, TASSELS, FRINGES, GIMPS, BUTTONS,
 AND ALL KINDS OF
UPHOLSTERY TRIMMINGS,

OFFICE AND FACTORY:

Over 98 East Main Street, - - ROCHESTER, N. Y.

ALBRECHT VOGT,
 MANUFACTURER OF
Gloak, Dress, Upholstery Trimmings
 AND BUTTONS,

No. 44 Exchange Street,

First Block from Swing Bridge, ROCHESTER, N. Y.

JAMES POWERS,

WORKER OF AND DEALER IN

GRANITE

Makes a specialty of GRANITE CUTTING,

MONUMENTS,
 HEAD-STONES,
 COPING,
 FENCES,

and all classes of CEMETERY WORK.

Granite Monuments in Cemeteries Lettered.

General Job Work for Building Purposes.

SHOP, 97 NORTH ST. PAUL STREET,

Opposite Ward Street, immediately on line of North St. Paul Street Cars,

ROCHESTER, N. Y.**NELLS & KERN,***(Successors to M. H. FITZSIMONS,)*

MANUFACTURERS AND DEALERS IN

MARBLE WORK

OF EVERY DESCRIPTION.

MONUMENTS,

Head-stones, &c.,

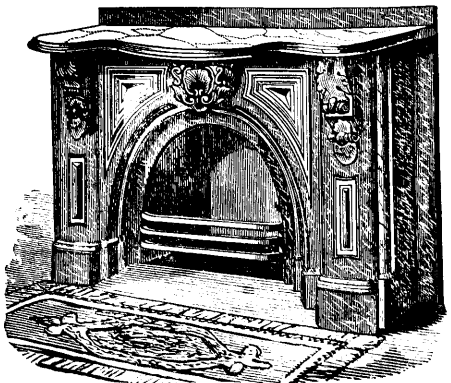
MARBLE MANTELS,Coal Grates, Plumber Slabs,
Furniture Tops, &c.,**No. 166 State Street,****ROCHESTER, N. Y.**

P. A. NELL.

J. J. NELL.

FRITZ KERN.

JAMES A. YOUNG,
MANUFACTURER OF
Ornamental Centre Pieces,
FROM THE VERY LATEST DESIGNS.

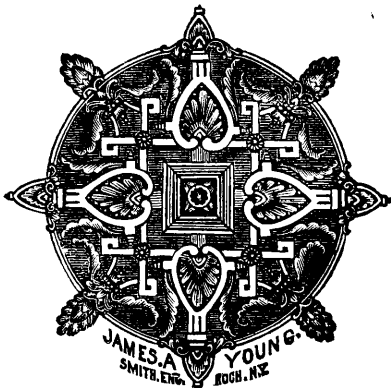

ORNAMENTAL WORK OF ALL KINDS

EXECUTED ACCORDING TO DESIGN.

Manufactory, No. 51 South St. Paul Street,

J. G. Wagner's Block.

ROCHESTER, N. Y.

SAM'L BENNETT & SON,

PROPRIETORS OF

GLEN HOUSE,

AT LOWER FALLS,

—AND—

Wharfingers, Foot of Buell's Avenue.

EXCURSION STEAMERS,

Running to CHARLOTTE, accommodating pleasure parties, on short notice, and at Reasonable Rates.

We have just finished the new and elegant Pleasure Steamer,

"City of Rochester,"

which will run on excursions to the Thousand Islands, Toronto, or any port on Lake Ontario. This boat, in connection with the Steam Yacht "W. J. Wilcox," enables us to provide for One Thousand People with safety.

Arrangements can be made by SUNDAY SCHOOLS or PIC-NIC PARTIES to charter these boats. EXCURSIONS TO CHARLOTTE DAILY DURING THE SEASON.

Persons wishing Ferry from the East side of the river, to take the boats or otherwise, can apply from the bank opposite Buell's Landing.

PLEASURE BOATS TO LET.

☛ REFRESHMENTS served at the Glen House at all hours.

JAMES FIELD,

40 and 42 Exchange Street, Rochester, N. Y.,

MANUFACTURER OF

TENTS, FLAGS, AWNINGS,

BOSTON

MANILLA ROPE,

COTTON

SEINE TWINE,

All Numbers.

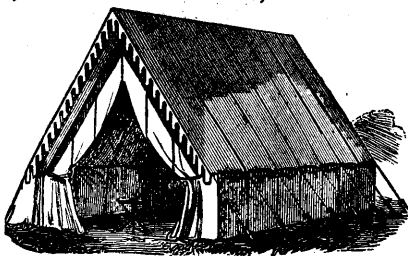
**GILLING TWINE,**

All Numbers.

Broom & Brush**WIRE,****NEEDLES,****KNIVES and
NAILS.****Horse and Wagon Covers, Elevator Belting, and Hammocks.**

Wholesale and Retail Dealers in

**STARK A GRAIN BAGS, Braided Sash Cord, Hemp and Cotton Sash Cord,
Rope, Cordage, Twine, Carpet Warp, Canvas, Duck and Bunting,
Tackle Blocks, Rosin, Tar, Pitch, Oakum, Spun
Cotton, Steam Packing and Waste.**

FISHING TACKLE,

**BREWERS' PITCH, Boat Oars, Row Locks, Canal Whiffletrees and Pike
Poles. Tobacco and Wool Twine.**

TENTS AND FLACS TO RENT.

ROCHESTER BRACKET WORKS,**22 and 24 East Main Street,**

Manufacture and offer at Wholesale and Retail the Largest and Best Assortment of

BLACK WALNUT**Brackets, Picture Frames, Mouldings,****WINDOW CORNICES and FANCY CABINET WARE,**

To be found in WESTERN NEW YORK. Buying all supplies in large quantities and manufacturing in the most systematic manner, we are enabled to sell at PRICES THAT DEFY COMPETITION, the largest stock of

STEREOSCOPIIC VIEWSAnd **STEREOSCOPIES,**

Ever Displayed in Rochester.

A. J. JONES.

JOHN WARING.

J. C. S. SCOTT.

WARING & SCOTT,
 DEALERS IN
COAL AND LUMBER,
 WHOLESALE AND RETAIL,

Every facility for furnishing either, in any quantity.

Commission Merchants and Dealers in Produce.
Nursery Exchange.

Nursery Stock of all kinds Bought and Sold on Commission.

LOCATION,

EAST MAIN STREET,

Corner Goodman, - - ROCHESTER, N. Y.

Situated immediately on the N. Y. C. & H. R. R. R.



DAVID BANTLEON,

WOOD TURNING.

Moulding and Sawing Mill,

MANUFACTORY,

River, cor. North Water Streets, Hydraulic Building, Rochester, N. Y.

Wood Turning of every description; also, Scroll and Circular Sawing done with Neatness and Dispatch.

OCTAGON AND FLUTED BALUSTERS; also, NEWELS AND RAILS

Constantly on hand or made to order.

MOULDINGS,

Straight and Circular, for Carpenters, Cabinet Makers and Piano Forte Manufacturers. In fact, all trades supplied in their different branches.

N. B.—All **JOBING** attended to Promptly and done at Reasonable Rates.

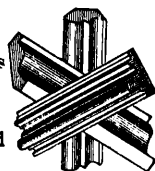

A. PRENTICE, SR.

A. PRENTICE, JR.

ALEXANDER PRENTICE & SON,

MANUFACTURERS,

Wholesale and Retail Dealers in

Pine ^{and} Hemlock Lumber

Shingles, Lath, Fence Pickets, Cedar Posts and Mouldings.

ALL KINDS OF

Planing & Sawing done to order.

PINE AND HEMLOCK BILL LUMBER SAWED TO ORDER.

Office, 158 Lake Avenue, ROCHESTER, N. Y.

THE ROCHESTER FREAR STONE COMPANY.

Down-Town Office, 73 South St. Paul Street,

Factory and Office, Mt. Hope Av., Foot of Hamilton Place, East Bank Genesee River,

MANUFACTURE THE

IMPROVED**Frear Stone,**

According to any Design required,

For Architectural and Cemetery Purposes.

At prices far below those of Fine Cut Stone, which it closely resembles. Thousands of FIRST-CLASS BUILDINGS have been erected, in which

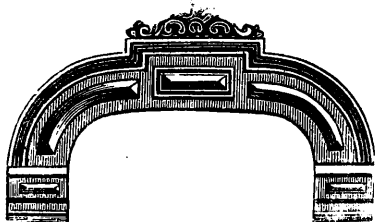
**The Frear Stone has been Used,**

And proved satisfactory to owners.

The Company have recently added to their extensive Works, the manufacture of strictly first-class

CARBONIZED STONE SEWER PIPE,

Made under Patents obtained by GEO. RICHARDSON, by which the connections are securely made. This Pipe will resist the acids or alkalies.

ORDERS SOLICITED.

P. H. CURTIS, Sec'y and Treas.

JOHN A. SMITH,

(SUCCESSOR TO EDWARD A. RIVERS.)

MANUFACTURER OF

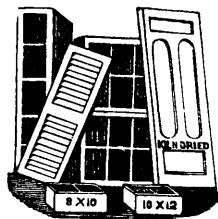

SASH,

DOORS

AND BLINDS.

All Doors Warranted Kiln Dried.

Glazed Windows, Mouldings, Brackets and Finishing Stock

Constantly on Hand and Made to Order.

TURNING IN ALL ITS BRANCHES.

Orders from Builders Solicited. Everything New. Machinery with Latest Improvements.

13 and 15 Warehouse St., Rochester, N. Y.

VROMAN & YOUNG,

BUILDING MOVERS,

WILL TAKE CONTRACTS FOR

Raising or Moving Buildings.

*We guarantee to use great care, and we give the Work
our Personal Supervision.*

Address at G. ROSENTHAL'S, 107 North Avenue, or

H. C. VROMAN,

8 Ontario Street.

H. YOUNG,

95 Weld Street.

WM. B. MORSE & CO.,
LUMBER YARD,

—AND—

STEAM PLANING MILL,
No. 30 West Avenue, corner Trowbridge Street,
ROCHESTER, N. Y.

Have constantly on hand and for sale a complete assortment of SEASONED PINE
and HEMLOCK LUMBER, also DRESSED FLOORING and SIDING,
SHINGLES, LATH, FENCE POSTS, Etc.

LUMBER PLANED AND SAWED TO ORDER.

W. B. MORSE.

S. G. HOLLISTER.

AMON BRONSON.

ESTABLISHED 1832.

AMON BRONSON, JR.

A. BRONSON & SON,
Lumber Merchants,

DEALERS IN

PINE AND HEMLOCK LUMBER,
Shingles, Lath, Fence Posts, Etc.

PLANING AND SAWING DONE TO ORDER AT OUR OWN MILL.

EXCHANGE STREET, FOOT OF TROUP, ROCHESTER, N. Y.

Established 1838.

WM. H. CHENEY'S
Architectural Iron Works

MANUFACTURER OF

BUILDING FRONTS, IRON COLUMNS.

106 South St. Paul Street,

ROCHESTER, N. Y.

CHASE & OTIS,

Wholesale and Retail

LUMBER DEALERS

PLANING AND SAWING DONE TO ORDER.

Court Street, near Exchange,

ROCHESTER, N. Y.

WHITMORE, BRADY & CO.,

Stone Dealers and Street Contractors

LOCKPORT, MEDINA AND ALBION STONE,

CUT STONE OF ALL KINDS,

FLAGGING, PAVING AND BUILDING STONE.

Office and Yard, Cor. Fitzhugh St. and Erie Canal, Rochester, N. Y.

IN CONNECTION WITH

W. W. WHITMORE & CO., Lockport, N. Y., and

WHITMORE, RATHBUN & CO., Buffalo, N. Y.

J. C. CAMERON.

E. B. CHACE.

CAMERON & CHACE,

WHOLESALE AND RETAIL DEALERS IN

SAGINAW LUMBER,

LATHS, SHINGLES,

FENCE POSTS and PICKETS,

Office and Retail Yard, No. 19 Warehouse Street,

Wholesale Yard, OAK STREET, between Smith and Lyell,

ROCHESTER, N. Y.

PLANING AND MATCHING DONE TO ORDER.

D. WHALEN,
 PLAIN AND ORNAMENTAL
PLASTERER,
 No. 16 Stone Street,

Rear Entrance on MINERVA PLACE,

Near East Main Street, - - - ROCHESTER, N. Y.



DEALER IN

FINE, SUPERFINE and DENTISTS'

PLASTER PARIS,

Marble Dust,

Rockaway Sand,

Hydraulic Cement,

—AND—

PLASTERING MATERIALS,

OF ALL KINDS.

TILE FOR SEWER PURPOSES.

Particular Attention Paid to Jobbing.

VITRIFIED, SALT-GLAZED STONEWARE, SEWER and DRAIN PIPE

Of from 3 to 24 Inch Calibre,

WITH ALL THE NECESSARY FITTINGS AND CONNECTIONS.

Manufactured by **OTIS & GORSLINE**, Rochester, N. Y.

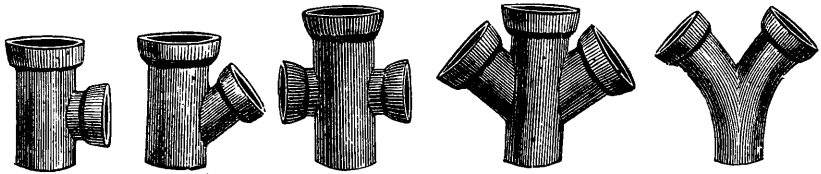

T BRANCH. Y BRANCH. DOUBLE T BRANCH. DOUBLE Y BRANCH. V BRANCH.

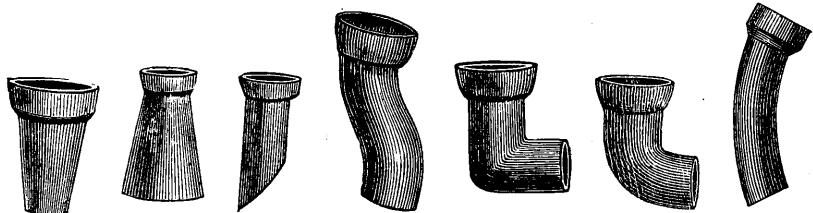

REDUCER. INCREASER. SLANT. OFFSET. ELBOW. 1/4 BEND. CURVE.

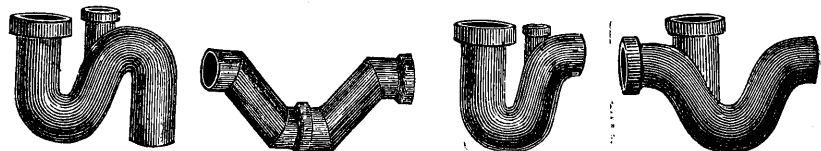

S TRAP. TWO-PIECE TRAP. P TRAP. RUNNING TRAP.

We are manufacturing a pipe that is indestructible from the action of all the elements, impervious to the action of acids, gases and steam, all of which are found in corporation sewers. These pipes are made from a combination of superior clays, which by powerful machinery are rendered uniform throughout—pressed from a steam press, under a pressure of *sixty-three tons* upon each pipe, it is made very compact; and burned in close kilns at a very intense heat, it becomes a thoroughly vitrified and iron-like body. All prominent architects, builders, and all those who have investigated the subject of sewerage, have become convinced that properly burned clay pipe is the only material suitable for underground drainage, and that the sewer and drain pipe manufactured from cement, carbonated stone, and other similar materials, are liable to and do *decay, disintegrate*, and become *worthless*, as has been many times proved by the officials in many cities.

These vitrified pipe are suitable for well tubing; are *better* than stone or *brick*, because cheaper, more durable, and can be made perfectly tight.

☞ We deliver our Pipe within the city limits free of charge, and in good condition.

OTIS & GORSLINE,

Office, 51 Powers' Block, ROCHESTER, N. Y.

Factory, Oak Street, between Smith and Lyell Streets.

ESTABLISHED 1833.

HOLLISTER & CO.,

Successors to

HOLLISTER & CHAMBERLAIN and the late E. H. HOLLISTER,

SAGINAW

LUMBER YARD,

102 Exchange Street,

Manufacturers, Wholesale and Retail Dealers in

LUMBER, SHINGLES,

LATH, CEDAR POSTS,

FENCE PICKETS.

PLANING & RE-SAWING MILLS.

Purchasers will find at all times the largest and most complete
Assortment of

Seasoned Pine and Hemlock Lumber

In the State, west of Albany.

McCONNELL & JONES,

STREET and SEWER

CONTRACTORS

AND MANUFACTURERS OF

ROOFING MATERIALS.

ALSO, DEALERS IN

Water Lime, Quick Lime, Plaster Paris, Vitrified and Cement
Sewer Pipe, Rosendale Cement, Fire Brick, Fire Clay,
Fire Sand, Kaolin, Rockaway Sand, Tile,
White Sea Gravel, Felt,
Cement, Tar, &c.



ALL KINDS OF

STREET AND SEWER JOBBING

DONE ON SHORT NOTICE.

Office and Warerooms, Exchange Street, corner Spring Street.

FACTORY, Corner Meigs Street and Pinnacle Avenue,

ROCHESTER, N. Y.

D. COPELAND, Jr.,

90 South St. Paul Street, Rochester, N. Y.,

MANUFACTURER AND DEALER IN

COPELAND'S CEMENT SEWER PIPE,

GARDEN ROLLERS, WELL TUBING,

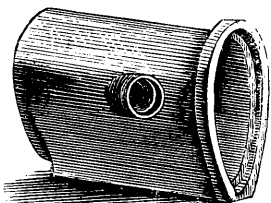

WATER LIME,
LIME,

PLASTER PARIS, DENTISTS' PLASTER,

Portland Cement, Rosendale Cement, Rockaway, Sand, Marble
Dust, Sea Gravel, Fire Brick, Clay, Sand, Kaolin,

—AND—

ALL KINDS OF MASONS' MATERIALS.

HORACE MAY,

Manufacturer of and Dealer in

QUICK LIME,

A SUPERIOR QUALITY OF

FRESH LIME

Constantly on hand at the Lowest Market Rates.

Is prepared to fill Orders for Shipping by the Barrel or Car Load.

Kilns on EAST AVENUE, Brighton.

OFFICE and DEPOT, 90 SOUTH ST. PAUL STREET,

ROCHESTER, N. Y.

STONE YARD.

WHITMORE, RAUBER & VICINUS,

Street and Sewer Contractors,

DEALERS IN

Medina Sand Stone,

NORTH RIVER BLUE STONE,

Platforms, Flagging,

Crosswalk, Curb, Paving

and Building Stone,

Water Lime and Stoneware Sewer Pipe,

DOOR AND WINDOW CAPS AND SILLS,

—AND—

All Kinds of Cut Stone.

CONTRACTING AND JOBBING DONE, AND ALL KINDS OF

Street and Sewer Work.

Particular attention given to

CONSTRUCTION AND REPAIRS OF SIDE WALKS.

Office and Yard,

No. 175 South St. Paul St., - ROCHESTER, N. Y.

PETER PITKIN,

MANUFACTURER OF

Granite Monuments,

VAULTS, TOMBS, SARCOPHAGI,

Bases, Sockets, Cemetery Posts, &c.

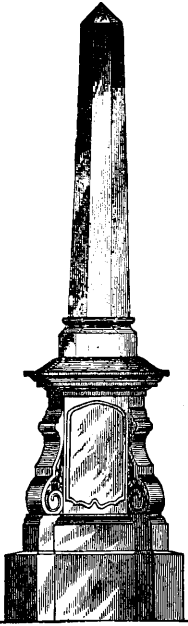

ALSO,

FENCES,

OF

Lockport Lime Stone,

BROWN STONE

OR

GRANITE.

Plans and Designs for Monuments always on hand at the Yard.

ALSO, MANUFACTURER OF

CUT STONE OF ALL KINDS,

Used for Building Purposes,

— INCLUDING —

CAPS, SILLS, CORNICES, CORNERS, &c.

The elegant Stone Work of the **FIRST BAPTIST CHURCH** Fitzhugh Street, now in process of erection, was cut and furnished by Mr. Pitkin.

The very fine fronts of **POWERS' FIRE-PROOF BUILDINGS** and **SMITH & PERKINS'** and **JOHN SCHLEYER'S** new Stores, were cut at this Yard.

ORDERS AND BIDS SOLICITED FROM ABROAD.

Yard, No. 22 West Avenue, - Rochester, N. Y.

WM. G. BUTLER,
COAL AND LIME,

HAS CONSTANTLY ON HAND THE FIRST QUALITY OF

BUILDING STONE.

MANUFACTURER OF THE BEST QUALITY OF

QUICK LIME.

DEALER IN

WATER LIME, PLASTER PARIS

AND

VITRIFIED SEWER PIPE.

Office and Yards:

Olean Street, OPP. FROST & CO.'S
NURSERIES. Rochester, N. Y.

Down-town Office:

Odd Fellows' Temple, - No. 123 West Main Street,

Where all orders may be addressed.

J. C. HEUGHES & CO.,

(Successors to J. LAVERTY & CO., Established 1865.)

Manufacturers of

Boot and Shoe Dies,

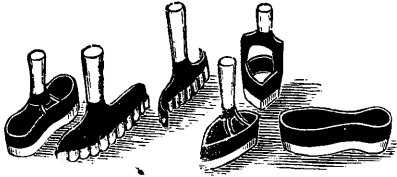

PAPER COLLAR and
CUFF CUTTERS,

Envelope and Box Cutters.

Also, Proprietors of the

ROCHESTER BOLT WORKS,

MANUFACTURERS OF ALL KINDS OF

BOLTS.

Heavy and Light Forging, Grinding and Polishing.

Office and Manufactory: Cor. Mill and Platt Sts., Rochester, N. Y.

THOS. G. PALMER,

ORNAMENTAL

IRON WORKS.

MANUFACTURER OF

Wrought and Cast-Iron

FENCES,

VERANDAS,

BALCONIES,

STAIRS and STAIR RAILINGS, Iron
Doors and Shutters, Grating, Iron
Sash, Show Windows, and

Bridge Irons, Bolts, &c.,

IRON VASES and URNS,

Iron Stable Furniture, &c.

87 Front Street,

ROCHESTER, N. Y.

Rooms for Manufacturing Purposes

TO LET.

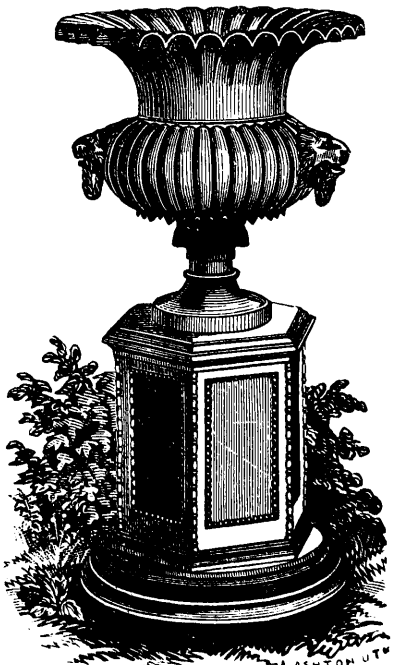

ESTABLISHED 1827.

PANCOST, SAGE & MORSE,

MAUFACTURERS OF

BOOTS AND SHOES,

AND

Agents for Rubber Factories,

No. 92 STATE STREET,

And 53, 55, 57 and 59 MILL STREET,

ROCHESTER, N. Y.

WM. N. SAGE.

EDWIN O. SAGE.

CHAS. C. MORSE.

JOHN L. SAGE,

JOHN DUFNER,

Manufacturer and Wholesale Dealer in



LASTS,

CRIMPS,

BOOT TREES AND CLAMPS,

Office and Factory: Shawmut Mill Building,

Mill Street, near Factory Street.

The special attention of Boot and Shoe Manufacturers throughout the United States solicited. Send for Price List.

Important to Boot and Shoe Manufacturers.

Elliott's Hand-Power BOOT-TREE,

The best, simplest and cheapest Boot-Tree ever manufactured. Great improvements in Boot-Trees for Boot Makers and Manufacturers, PATENTED JULY 1, 1873.

TO THE TRADE.

The undersigned respectfully introduces the newly patented Elliott's Hand-power Boot-tree to his patrons and the trade generally, with the full confidence that this is the best and cheapest Boot-Tree ever manufactured, doing the work easier and fully as good as any other costly and complicated Boot-Tree.

RETAIL PRICE, \$10.

JOHN DUFNER, ROCHESTER, N. Y., Sole Manufacturer for the United States.

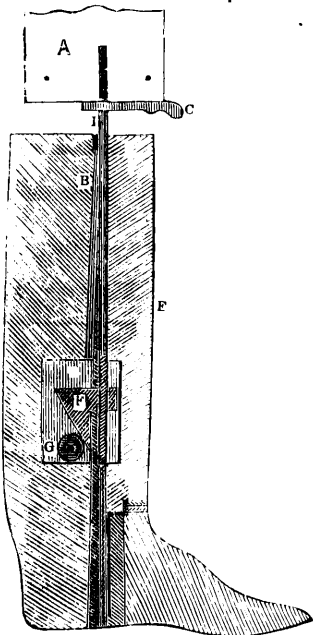

A. J. JOHNSON & CO.,

MANUFACTURERS OF

Ladies' and Misses' Shoes,

ROCHESTER, N. Y.

Manufactory, State corner Allen Street,

OFFICE, No. 4 ALLEN STREET.

A. J. JOHNSON.

JOHNSON I. ROBINS, JR.

PHELAN & BOLTON,

Wholesale Manufacturers of

Ladies', Misses', Youths' and Children's

FINE SEWED SHOES,

Corner N. Water and Andrews Streets,

Office on the River Side.

ROCHESTER, N. Y.

Rochester Boot Manufacturing Co.,

MANUFACTURERS OF

Men's Boys' and Youth's

FINE BOOTS AND SHOES,

Hand Pegged, Hand and Machine Sewed.

81 North Water Street, - ROCHESTER, N. Y.

GOODWIN & BISHOP,

Wholesale Dealers in

Men's, Boys', Women's, Misses' and Children's

BOOTS & SHOES,

AND RUBBER GOODS,

109 State Street,

ROCHESTER, N. Y.

Opposite Mumford Street, First Floor.

FRANK E. GOODWIN.

FRANK B. BISHOP.

ALLING BROTHERS, TANNERS, CURRIERS

And Dealers in all kinds of
SHOE AND HARNESS LEATHER,
UNION, OAK AND HEMLOCK,

HIDES, OIL AND TALLOW.

Cash for Hides, Tallow and Rough Leather.

**Nos. 49 and 51 North Water Street,
ROCHESTER, N. Y.**

S. Y. ALLING.

L. H. ALLING.

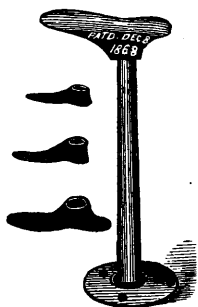

TOWNSEND & WISEMAN,

Successors to G. G. Townsend,
MANUFACTURERS OF

Shoemakers' Tools,

Office and Salesroom,

Stewart's Building, Andrews St. Bridge,

W. TOWNSEND, }
A. WISEMAN. }

ROCHESTER, N. Y.

FRANK FRITZSCHE,

DEALER IN

HIDES AND SKINS,

LEATHER, OILS, &c.,

No. 43 Front Street, - - Rochester, N. Y.

CARING, WEICHER & CO.,

Successors to HENRY LAMPERT & CO., and Wm. CARING & SON,

Tanners and Morocco Manufacturers

Wholesale and Retail Dealers in all kinds of

BOOT AND SHOE LEATHER AND FINDINGS,

No. 87 North Water Street,

(LAMPERT'S BUILDING),

GEORGE CARING, }
JACOB J. WEICHER, }
M. GREENTREE. }

ROCHESTER, N. Y.

DAVIS, MOULTON & CO.,

(Successors of GOODWIN, DAVIS & Co.),

MANUFACTURERS AND WHOLESALE DEALERS IN

BOOTS & SHOES,

36 Exchange Street,

F. W. DAVIS,
D. MOULTON,
J. C. CARR.

ROCHESTER, N. Y.

JAMES J. EVANS,

Wholesale Manufacturer of

Men's, Women's, Misses', Boys' and Youth's

BOOTS & SHOES,

9, 11 and 13 River Street,

ROCHESTER, N. Y.

STEWART RUBBER CO.,

MANUFACTURERS OF

RUBBER GOODS,

—ALSO—

J. T. STEWART & SON,

Manufacturers and Jobbers of

BOOTS AND SHOES,

Andrews corner North Water Street, - - ROCHESTER, N. Y.

Rooms to rent with or without power, in Stewart's new buildings.

REED & WEAVER,

WHOLESALE MANUFACTURERS OF

LADIES', MISSES' AND CHILDREN'S

Fine Shoes,

No. 111 State Street, - ROCHESTER, N. Y.

KALB, HAHN & CO.,

Manufacturers of and Dealers in

LEATHER AND SHOE FINDINGS.

Also, Importers of the

GERMAN CORDOVAN LEATHER,**No. 5 Mumford Street,***ROCHESTER, N. Y.*F. J. KALB,
C. HAHN,
C. W. RAMPE.)

All Orders will be promptly Attended to

Established March, 1867.

ROCHESTER INSOLE M'FG CO.,

MANUFACTURERS OF

Cork Insoles, Shoe Fittings & Over-Gaiters,**75 North Water St., Rochester, N. Y.**

W. WILLIAMS, Gen'l Agent.

GEORGE E. MORSE, Sec'y and Treas.

PRICE LISTS AND SAMPLES FURNISHED ON APPLICATION.

FERDINAND END,

DEALER IN

BOOTS AND SHOES,*7 Andrews Street, corner North Water,*

AND

Manufacturer of **SLIPPERS** at Wholesale.We make the Celebrated **FOXED CLOTH SLIPPER** and the Popular
FELT and WOOL-LINED HOUSE SLIPPERS.*Wholesale or Retail Dealers Supplied in any Quantity.***Branch Store: 32 Herman St., Rochester, N. Y.****HENRY LAMPERT,****TANNER,****81 NORTH WATER STREET, ROCHESTER, N. Y.**

OWNER OF LAMPERT'S MANUFACTURING BLOCK, 73 TO 97 NORTH WATER STREET.

Rooms, with Steam Power, to Let.**TANNERIES—Mansion Street, Rochester, and at Nunda, N. Y.**

*FLOWER CITY CORK MILLS.***TAYLOR & CO.,**

MANUFACTURERS OF

CORKS!*Machine Cut Corks of every Description:*

CORKS SHAVINGS FOR SALE.

CORRESPONDENCE SOLICITED.

Office and Factory, 205 Plymouth Avenue, - Rochester, N. Y.

GATCHELL & CO.

PROPRIETORS OF THE

ROCHESTER GLASS WORKS,

MANUFACTURERS OF

Glass Bottles, Flasks, etc.

178 PLYMOUTH AVENUE, ROCHESTER, N. Y.

Connected for 21 years with the LANCASTER GLASS WORKS.

C. B. WOODWORTH & SON,

Manufacturing Perfumers

ROCHESTER, N. Y.

New York Office, - - 335 Broadway, Room 18.

A. SPIEHLER,**CHEMIST,**

And Manufacturer of

FINE PERFUMERIES,

FLAVORING EXTRACTS, ETC.

No. 24 East Main Street, - - ROCHESTER, N. Y.

TAYLOR BROTHERS,

Manufacturers of

Thermometers,

Barometers,

Hydrometers, &c.

No. 3 HILL ST.

Near the West Main Street
New Swing Bridge,

Rochester, N. Y.

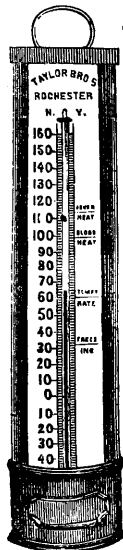

HENRY MILES.

WM. R. WARREN.

HENRY MILES & CO.,

DEALERS IN

PAPER

—AND—

Paper Stock,

COTTON and WOOLEN RAGS,

Tinware, Metals, Iron, &c.

*Highest Cash Price Paid for the
above articles.*

No. 83 South St. Paul Street,

ROCHESTER, N. Y.

WM. COONEY,

MANUFACTURER OF ALL KINDS OF

BRUSHES.

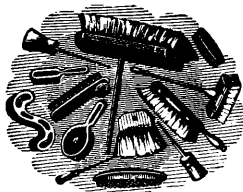

All Orders Promptly Filled.

Foot of Aqueduct Street, - Rochester, N. Y.

STRONG & WOODBURY,

MANUFACTURERS OF

Whips and Lashes,

OF EVERY DESCRIPTION,

Allen Street, cor. North Washington,

HENRY A. STRONG. }
EDMUND F. WOODBURY. }

ROCHESTER, N. Y.

Inventors and Sole Manufacturers of the Celebrated **STITCHED CORD
HANDLE**, Patented December 18, 1866.

SIDNEY CHURCH,
MANUFACTURER OF
ROPE, CORDAGE AND TWINE,
All kinds of COTTON and LINEN TWINE constantly on hand,
Tar, Pitch, Oakum and Tackle Blocks,
Office and Factory, 167 West Avenue,
ROCHESTER, N. Y.

☛ West Avenue Street Cars Pass the Office.

LEVI HEY,
WHOLESALE DEALER IN
SOFT AND HARD WOOLEN AND COTTON
RAGS,
And all Kinds of Paper Stock, Junk, Old Metals, Etc.
Also, RAG AND STRAW WRAPPING PAPER,
215 State Street, - Rochester, N. Y.
Manufacturer of **TIN WARE**, and dealer in **Glass Ware. &c.**
AT WHOLESALE OR RETAIL AT
No. 244 State Street, - - Rochester, N. Y.

JAMES LANEY,
WHOLESALE DEALER IN
Paper and Paper Stock,
COTTON AND WOOLEN RAGS,
Manufacturer of **TIN WARE**. Wholesale Dealer in **CIGARS, Glass, Japaned, Stamped and Wooden Ware, Etc.**
Rags, Feathers, and all kinds of Old Metal bought for Goods or Cash.
144 EAST MAIN STREET, }
WAREHOUSE, 5 LANCASTER STREET, } **ROCHESTER, N. Y.**

ROCHESTER PLATING WORKS.

NICKEL PLATING A SPECIALTY.

—ALSO,—

GOLD AND SILVER PLATING.

HENRY CHURCHILL, Agent,

No. 122 Mill Street,

(Up Stairs.)

ROCHESTER, N. Y.

H. & A. WIDDOWSON,
MACHINISTS,
Manufacturers of
Stave Jointers, Last Lathes,
PROOF STAFFS, &c.

Brown's Race, { *Foot Platt St.,* }
 { *Michel's Building,* } **Rochester, N. Y.**

General Jobbing and Repairing Promptly Done.

SAMUEL PORTER,

(Successor to J. H. WILSON & CO.),

MANUFACTURER OF

BARREL HEADING,

AND DEALER IN

STAVES and HOOPS,

OAK STREET, - ROCHESTER, N. Y.

W. LOVECRAFT,

DEALER IN

HOOPS, STAVES,

HEADING, COOPERAGE STOCK, &c.

92 Allen Street,

West Side of Allen St. Bridge, - ROCHESTER, N. Y.

JOSEPH LOVECRAFT & SON,

BARREL HEAD MANUFACTURERS;

OFFICE AND FACTORY:

No. 92 Allen Street, Rochester, N. Y.

J. S. GRAHAM & CO.,

MANUFACTURERS OF

WOOD WORKING MACHINERY.

Woodworth Planers and Matchers

A SPECIALTY.

Mill Street, near Factory, - Rochester, N. Y.

F. ERDLE,
M A C H I N I S T,

AND MANUFACTURER OF

UPRIGHT AND HORIZONTAL DRILLING MACHINES,

Wood Turning and Pattern Makers' Lathes, Slab Saws, Cut-off Saws, Mully and Circular Saw Mills.

SAW MANDRELS of all descriptions MADE TO ORDER,

Having disposed of my interest in the Mill Machinery business, formerly carried on by ERDLE & OLIVER, I am now prepared to do Job Work in the best possible manner, and at figures that must suit all.

Address,

F. ERDLE, 129 Mill St., Rochester, N. Y.

HENRY WRAY.

ESTABLISHED 1842.

HENRY WRAY, JR.

HENRY WRAY & SON,

BRASS FOUNDERS,

109 Mill Street, Rochester, N. Y.

All kinds of Brass and Composition Castings Done at Short Notice.

BABBIT METAL CONSTANTLY ON HAND.

Agents for Bodine's Jonval Turbine Water Wheel.

PETER KELLY,

BUILDER OF

STEAM BOILERS *and* TANKS,

OF ALL KINDS.

Repairing and Jobbing Done to Order

AT SHORT NOTICE,

Mill Street, near Platt Street, Rochester, N. Y.

C. R. TOMPKINS.

H. F. SMITH.

C. R. TOMPKINS & CO.,
Rochester Wood Tool Manufactory,

Mill Street, corner Factory, Rochester, N. Y.

MANUFACTURERS OF

WOODWORTH PLANING AND MATCHING MACHINES,

Re-Sawing Machines, Sash, Door and Moulding Machinery.

J. FLINT,

MANUFACTURER OF

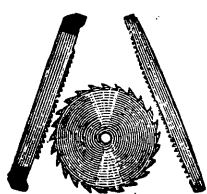

S A S A W S,
SAWS SAWS SAWS

Dietrich's Patent Double Handle Rip Saw,

PLASTERING TROWELS, Etc.,

No. 153 State Street, - Rochester, N. Y.

L. ZIEGLER & CO.,

Manufacturers of

PUMP AUGERS,

And PUMP RIMMERS,

Hub Augers, Hub Rimmers, Millwright and Carpenter's Augers,
 Machine Augers, Bits, &c.

REPAIRING DONE TO ORDER.

HAVE REMOVED TO

Foot of North Water Street, near Genesee Falls, Rochester, N. Y.

BELDING PLOW MANUFACTORY.

H. H. HEWITT,

PLOWS, CULTIVATORS,

AND ALL KINDS OF

CHILL PLOWS.

Agricultural Implements Made and Repaired.

PLATT STREET, COR. STATE, ROCHESTER, N. Y.

MILLINGTON & THOMAS,
 PRACTICAL
COPPERSMITHS,
Tin and Sheet Iron Workers.

All Kinds of Brewery and Distillery Work Attended to with Promptness and Dispatch. Soda Fountains, Stock Pots, Stew Pans, Made and Re-Tinned.

No. 2 Ely Street, - - - - Rochester, N. Y.
 S. A. MILLINGTON. B. F. THOMAS. H. P. MILLINGTON.

HENRY BEISHEIM,
 145 North Water Street, Rochester, N. Y.

PRACTICAL
M A C H I N I S T,

AND MANUFACTURER OF
 Machinists' Tools, Wood Working Machinery, Mason's Patent
 Scroll Saw. Jobbing in Iron and Brass. Particular
 attention paid to

MANUFACTURING AND DEVELOPING NEW PATENTS, MODELS, ETC.

C. MILLER,
MODEL MAKING,
Brass Finishing,

—AND—
MACHINE WORK.

Sewing Machines Repaired.

No. 107 North Water Street, - Rochester, N. Y.

Rochester Steam Fire Engine Works.

EDWIN B. SINTZENICH, Proprietor.



I am prepared to furnish light **PISTON FIRE ENGINES** of simple construction, that can be easily handled, and will throw two powerful streams, suitable for villages, at a low price. Also, large Engines.

Special attention paid to building and repairing Threshing Machines, Engines and Boilers. Also, my Patent Boiler, which will save from ten to fifteen per cent. of fuel. General Jobbing done.

No. 12 South Water Street,
 Boiler Shop, 7 South Water Street, - Rochester, N. Y.

THE HUBBARD

CHANGEABLE SPEED

Reapers & Mowers,

MANUFACTURED BY THE

Rochester Agricultural Works.

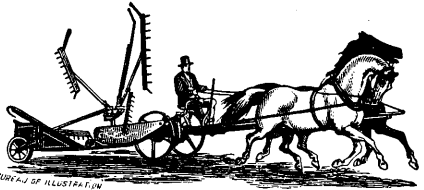

ROCHESTER, N. Y.

THE GLEN & HALL MANUFACTURING CO.,

Factory, East Avenue, near Brighton,

Office, South Water Street, Rochester, N. Y.

MANUFACTURE

Threshing Machines,

HORSE POWERS, &c.

Repairs for all Machines made by Joseph Hall, Glen & Hall, or ourselves, constantly on hand.

LESTER & GILLARD, PATTERN MAKERS.

Patterns for Machinery and Stoves, and Wooden Models,

Made Promptly and at Reasonable Charges.

Mill Street, opp. Factory Street (Shawmut Building),

ROCHESTER, N. Y.

AMOS WALDER, PATTERN AND MODEL MAKER.

Machinery, Architectural, Gear and Stove Patterns

MADE IN THE BEST MANNER.

DRAWINGS FURNISHED WHEN REQUIRED.

Hard and Soft Wood Machine Frames made to Order. Also, Scroll and Circular Sawing.

130 MILL STREET, ROCHESTER, N. Y.



MAHLON GREGG,

MANUFACTURER OF

STAVE MACHINE KNIVES,

Stave Jointer Knives, Wood Plauer Knives,

COOPERS' EDGE TOOLS, ETC.

Foot of Falls Street, - - - Rochester, N. Y.

ESTABLISHED 1832.

INCORPORATED 1875.

D. R. BARTON TOOL CO.,

SOLE MANUFACTURERS OF GENUINE

D. R. BARTON EDGE TOOLS,

Goods Stamped "D. R. Barton & Co." are NOT made by us. For
GENUINE "D. R. Barton" Edge Tools, Planes, Axes, &c.,
be sure to address D. R. BARTON TOOL CO., and
NOT D. R. Barton & Co.

Factory and Office,
Mill Street, corner of Furnace.

D. R. BARTON TOOL CO.,
Rochester, N. Y.

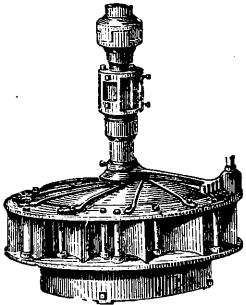

FINZER & ZARGES,

PRACTICAL

MILLWRIGHTS,

AGENTS FOR

James Leffel's Water Wheels,

13 SOUTH WATER STREET,

FILEN FINZER, }
OTTO ZARGES, }

Rochester, N. Y.

JOSEPH COWLES,

Practical Millwright,

AGENT FOR AND PUTS IN OPERATION

TURBINE WHEELS,

Also, gives personal attention to the construction and putting
in of Water Wheels for

Flour and Grist Mills, Paper Mills and Saw Mills,

127 Mill Street, near Platt, Rochester, N. Y.

CENTRAL MACHINE SHOP.

CLAGUE, RANDALL & CO.,

MANUFACTURERS OF

Pamphlet Covering Machines,

Are prepared to do all kinds of

JOBGING and REPAIRING ON SHORT NOTICE.

Work for Printers and Bookbinders a Specialty.

LAWN MOWERS SHARPENED and REPAIRED,

At No. 1 Aqueduct Street, - - Rochester, N. Y.

HENRY KOHLMETZ,

MANUFACTURER OF

Trucks and Baggage Barrows,

ORNAMENTAL IRON FENCES,

Balconies, Railings, Doors, Shutters, Grates, Awning-Irons, Window Sash,
Bridge Bolts, and all kinds of Wrought Iron Work for Buildings.

JOB WORK PROMPTLY ATTENDED TO AND NEATLY EXECUTED.

No. 121 North Water Street, Rochester, N. Y.

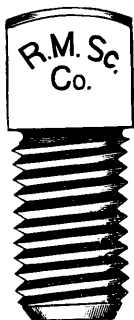

CHAS. P. BOSWELL, Pres't.

GEO. C. CLARK, Sup't.

H. W. SMITH, Sec'y.

ROCHESTER MACHINE SCREW CO.,

Established 1870.

Mill, cor. Furnace Street, Rochester, N. Y.

MANUFACTURE

Milled Machine Screws and Taps.

SEND FOR PRICE LIST.

ADRIANCE, PLATT & CO.,

MANUFACTURERS OF THE

BUCKEYE

MOWER AND REAPER,

No. 165 Greenwich Street, near Cortlandt,

Manufactory, POUGHKEEPSIE, N. Y.

NEW YORK.

H. R. WESTERVELT, Gen'l Agent for Western and Northern N. Y.

Ford Street, cor. Erie Canal, ROCHESTER, N. Y.

FLOUR CITY BAG WAREHOUSE.

J. GEO. CRAMER,

MANUFACTURER OF

PAPER FLOUR SACKS,

DEALER IN

Grocers' Bags, Grain Bags, Feed Bags, Twines, &c.

The First and Only Manufacturer in the City.

25 West Main Street, opp. the Arcade, Rochester, N. Y.

CHAS. M. EVEREST,

WHOLESALE DEALER IN

REFINED PETROLEUM,

Office, 128 Powers' Block,

Warehouse, 1 Glasgow Street, ROCHESTER, N. Y.

PHILIP HODECKER,

MANUFACTURER OF

TIGHT COOPERAGE.

Work Done to Order on Short Notice and on Reasonable Terms.

TANKS, CASKS, BARRELS and KEGS for BREWERS and DISTILLERS, a Specialty. Old Work Repaired.

Manufactory, 5 Thompson Street, ROCHESTER, N. Y.

JOSEPH BROWN.

C. J. ROBINSON.

BROWN & ROBINSON,

Manufacturers of all kinds of

TIGHT COOPERAGE.

Filter Manufacturers and Repairers.

Iron Bound Whisky, Cider and Ale Barrels and Kegs;
Iron Bound Half Barrels; Pork Barrels, for
Family use; Packing Barrels; Pound-
ing Tubs, Churns, &c.

REPAIRING AND ALL KINDS OF CUSTOM WORK.

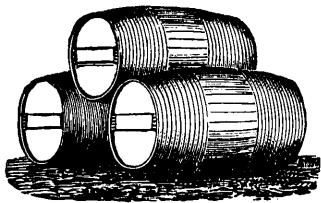

30 CANAL STREET,

ROCHESTER, N. Y.

OFFICE OF
MACNEALE & URBAN'S
CINCINNATI

Safe and Lock Works

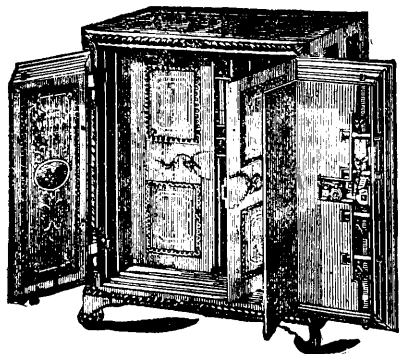

H. N. NICHOLS, } Agents.
C. C. HICKS, }

Room 6,
Corinthian Hall Building,
ROCHESTER, N. Y.

H. N. HEMINGWAY, **FOUNDRY.**

SPECIALTY OF FINE AND SMALL

CASTINGS & BUILDERS' HARDWARE,

Also, stock on hand of

Brackets, Wardrobe Hooks, Drawer Pulls, Foot Scrapers, Barrel Bolts, Bed Oasters,
Bed Locks, School Desk Ends, Church Book Racks,

BARN DOOR HANGERS, RAIL AND STAYS,

Hay Racks, Mangers, Stall Guards, Harness Hooks, Gate Latches, Door Handles, Counter
Legs, Children's Wagon Wheels and Axles, Towel Rack Feet, Clothes Reels,
Table Slides, Bake Pans, Waffle Irons, Masticators, Pump Spouts,
&c., &c.,

No. 150 North Water Street, - Near Railroad,
ROCHESTER, N. Y.

WILLIAMS & BASSETT,

(Successors to WARFIELD & CO.),

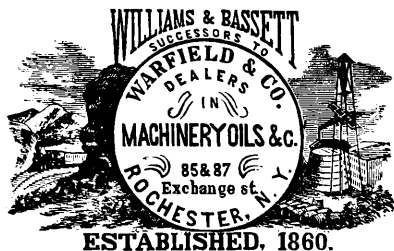

MANUFACTURERS OF

LUBRICATING OILS,

Wholesale and Retail.

GOODS WARRANTED.

Office, 85 and 87 Exchange Street,
Works, Foot of Cliff Street,
ROCHESTER, N. Y.

We received the **FIRST PREMIUM** at the New York State Fair, 1874, for
BEST COLLECTION OF MACHINERY OILS.

G. J. KINGSBURY.

GEO. T. DAVIS.

KINGSBURY & DAVIS,

Successors to J. HOLYLAND, Manufacturers of

CRACKER AND BISCUIT MACHINERY.

Also, VALE'S ROTARY OVEN.

Shawmut Building, - Mill Street,
ROCHESTER, N. Y.

Descriptive Catalogues Furnished on
 Application.

Also, Manufacturers of

HAMILTON'S PATENT

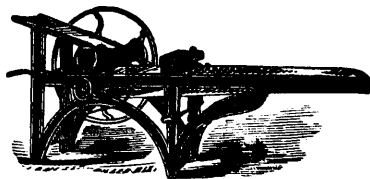

Oscillating and Reciprocating

SAW HANGINGS,

Manufactured at their Works in

Shawmut Building, Mill St., Rochester, N. Y.

VACUUM OIL COMPANY

MANUFACTURERS OF

LUBRICATING OILS.

Also, the Celebrated

Vacuum Oil Blacking,

(FOR HARNESS.)

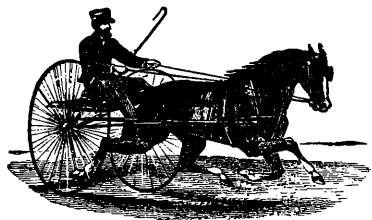

WHOLESALE DEALERS IN

Sperm, Whale, Elephant, Lard and Signal Oils.

MANUFACTORY, Cor. of Mansion and Flint Streets.

OFFICE NO. 128 POWERS' BUILDINGS,

ROCHESTER, N. Y.

N. B.—Office and Works connected by Telegraph.

M. BRIGGS & SON,

188 STATE STREET, - ROCHESTER, N. Y.

Manufacture the

BRIGGS' PATENT

FIRE-PROOF SAFE,

Briggs' Patent Burglar-Proof Safe,

ORNAMENTAL

IRON FENCES,

Balconies, Vases, Settees,

BANK DOORS AND VAULTS, IRON SHUTTERS, &c.

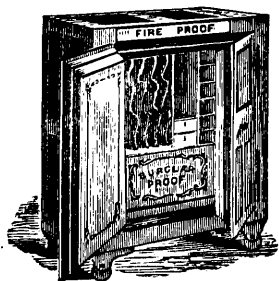



SHORER & TAILLIE, Iron Founders,

AND MANUFACTURERS OF

IRON COLUMNS,

LINTELS, CORNICES, CRESTINGS, &c.,

Also, do a general business of

Machine or Miscellaneous Casting.

PATTERNS MADE TO ORDER.

Office and Foundry,

145 to 151 NORTH WATER STREET,

ROCHESTER, N. Y.

A. SCHIRCK.

G. SCHIRCK.

JOSEPH SMITH.

A. SCHIRCK & CO.,

AXLE MANUFACTURERS,

PATENT EXCELSIOR.

15 Warehouse Street, Rochester, N. Y.

AXLES, BOXES AND NUTS

Made with extreme care and from Iron of the best quality.

Also, Patentees and Manufacturers of a



PATENT OIL GROOVE,

A Continuous Lubricator. Also,

PATENT STEEL COLLAR ON IRON AXLE.

ROCHESTER OCHRE

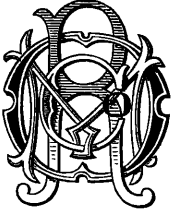
MINING  COMPANY

MANUFACTURERS OF VERY SUPERIOR

IRON EARTH PAINTS,

Warranted to be the best Paint in use of its kind.

Sold in powder, and can be mixed without oil. For Railroads, Barns, Fences, or any class of out-door work, this is the

CHEAPEST AND MOST DURABLE PAINT KNOWN,

And for Iron, Tin, and all kinds of Wood work exposed to heat and fluctuating weather no protection yet given is at all comparable with our paints. The colors are brilliant and clear, not dead and lustreless. In body, spreading and covering power they exceed any other paint in market.

Address all communications with stamp to

J. P. McMANNIS, Sec'y and Treas. Rochester Ochre Mining Co.,

91 North Water Street, or

Box 395, Rochester, N. Y.

EZRA JONES.

J. EMORY JONES.

EZRA JONES & SON,
EAGLE FOUNDRY AND MACHINE SHOP,

BROWN'S RACE, Foot of Furnace Street,

ROCHESTER, N. Y.

CASTINGS OF EVERY DESCRIPTION MADE TO ORDER.
MILL WORK AND GENERAL JOBBING
PROMPTLY ATTENDED TO.

Also Manufacturers of the

CENTENNIAL WATER WHEEL.

Catalogue of Gearing furnished on application.

J. C. SCHAFFER,
MOULD MAKER

— AND —

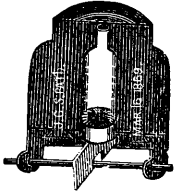

MACHINIST,

Successor to

Badger Machine Works,

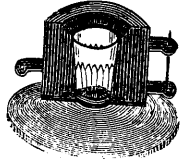

No. 6 Hill Street, Rochester, N. Y.

Every description of Moulds used in the manufacture of

GLASS, BRITANIA, RUBBER, ETC.,

MADE TO ORDER.

Soap Moulds and Dies. Also Presses for Glass Manufacturers.

MR. SCHAFFER has had issued to him Letters Patent for the manner of fastening Greenhouse Moulds, which does away with the old method of fastening with bolts, and therefore avoids expansion and contraction, *i. e.*, the bottoms of his Moulds are fastened with dovetails.

MANUFACTURER OF IMPROVED

Hoisting Machinery, Freight Elevators, Etc.,

For Stores, Warehouses, Factories, &c. Also, Manufacturer of

HYDROSTATIC PRESSES,

of from 100 to 500 tons pressure, designed for all purposes where great pressure is required.

Lawn Mowers of all kinds Repaired.

Extra pieces from the Manufacturers constantly on hand and furnished at the Manufacturers' Prices.

JOB WORK PROMPTLY ATTENDED TO.

F. P. MICHEL,
 MANUFACTURER OF
MACHINISTS' TOOLS, LATHES,
 OF ANY SIZE AND LENGTH,
Planers, Drills, &c.,
SHAFTING, PULLEYS, HANGERS,
Mill Work, Grain Scouring Machines

AND ALL KINDS OF

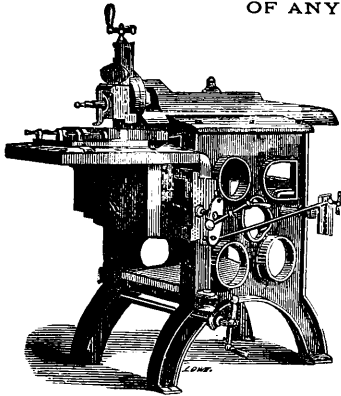

SHAPING PLANER.
 Planes 12 x 18 inches; has quick return motion.

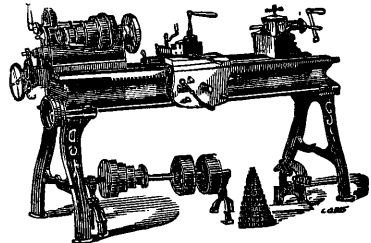

MACHINE WORK.

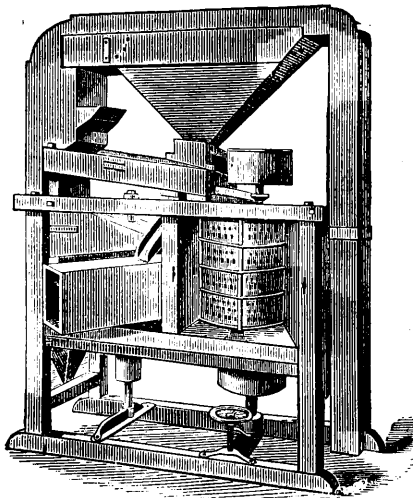

TO MILLERS.—This is the **B. T. TRIMMER,**
 Improved Excelsior Adjustable
Grain Scouring, Rubbing and Separating Machine Combined.

This Machine is without any doubt, the best and most perfect invention of the kind ever introduced for Scouring, Cleaning and separating grain. It will do all it is recommended. It will do better scouring and rubbing, and will put a better polish on the grain than any other machine of the kind. *This we guarantee.* It leaves the berry polished smooth, as it should be to make good flour. *There is no mistake about this.* I challenge the world to produce a machine of the same size and square inches of Scouring Case, that will perform its work equal to this without using part of this invention. It requires but little power to drive, and only runs 350 to 400 revolutions per minute.

This machine is protected by several Patents, and all infringers will be prosecuted. Address,

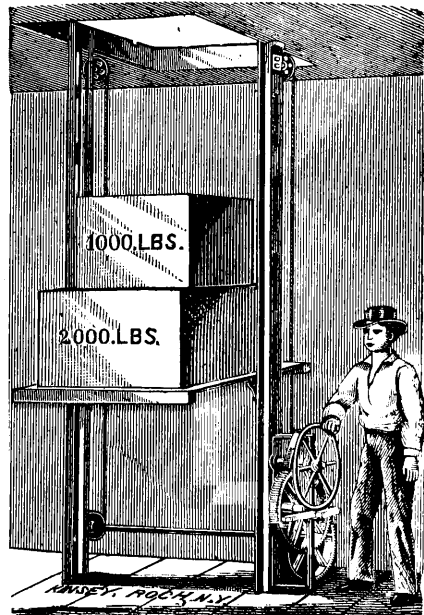

MANUFACTURER OF

Side-Walk Elevators,

Will raise 3,000 lbs. with ease.

Prices and capacity furnished on application.

F. P. MICHEL, Manufacturer, MILL ST., Foot of Platt, Rochester, N. Y.

Kidd Iron Works,

WILLIAM GLEASON, Proprietor,

Brown's Race, - Rochester, N. Y.

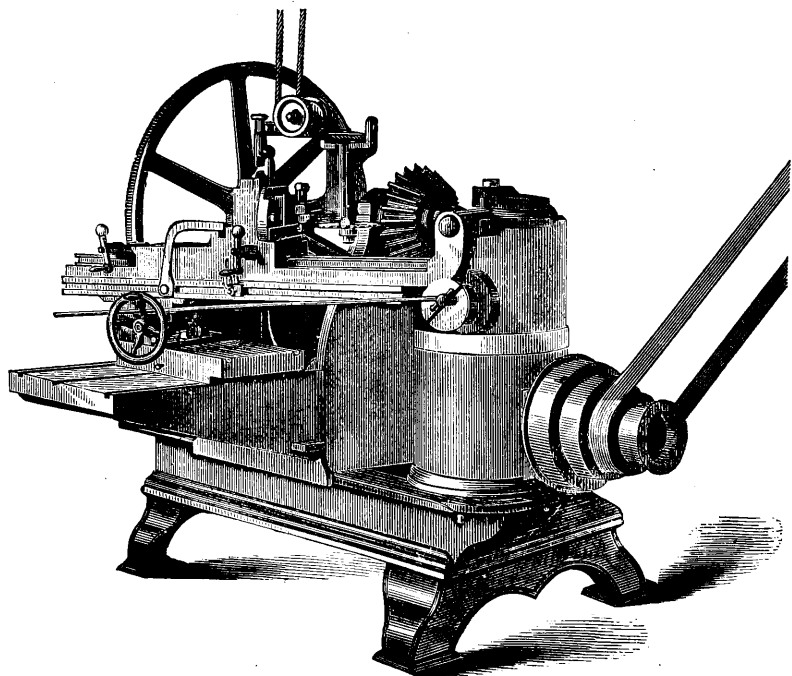

GLEASON'S GEAR DRESSING MACHINE,

Patented, April 11th, 1876.

THE above cut is a representation of a machine for dressing Gear Wheels, Bevel and Spur, Iron and Wood, to any desired shape of cog. It planes the bevel gears on the perfect reducing cut, giving the exact shape to the cog at the small as well as the large end. Gear Patterns can be made on it. Machines warranted.

Special attention given to Dressing all kinds of Gears, and at Reasonable Rates.

IRON GEAR PATTERNS of every description made to order.

LATHES, PLANERS & DRILLING MACHINES,

Of the latest improved patterns, on hand and made to order.

ESTABLISHED IN 1831.

D. A. WOODBURY.

JAMES E. BOOTH.

HENRY H. PRYOR.

WOODBURY, BOOTH & PRYOR,

Manufacturers of Stationary Steam Engines
and Boilers, as a Specialty.

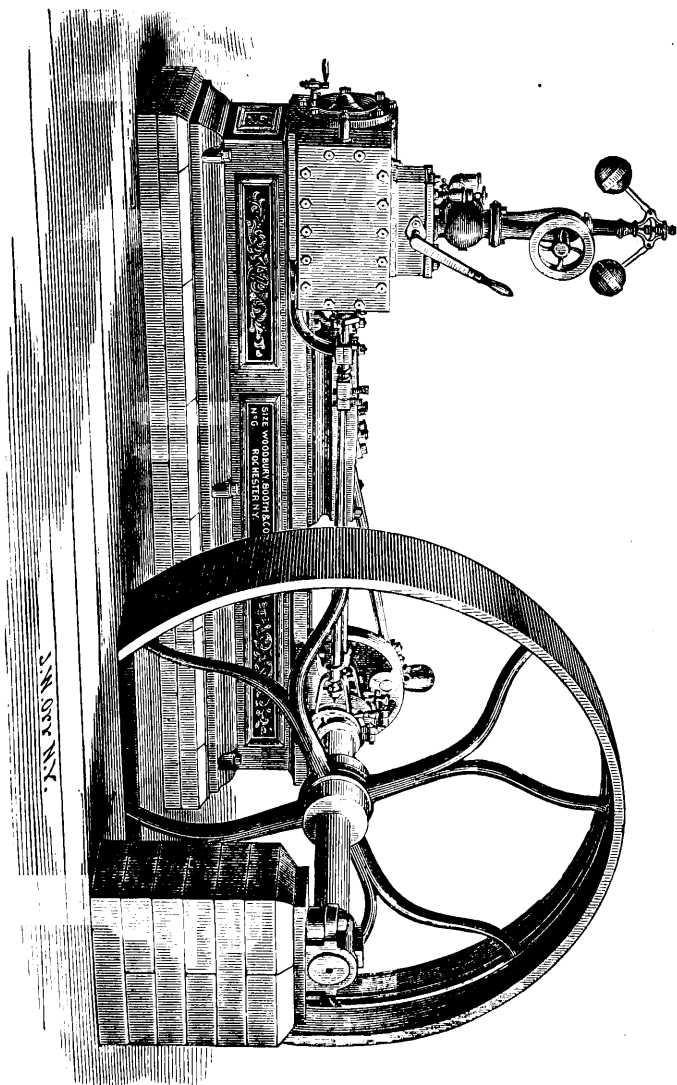

MILL STREET, NEAR PLATT,
ROCHESTER, N. Y.

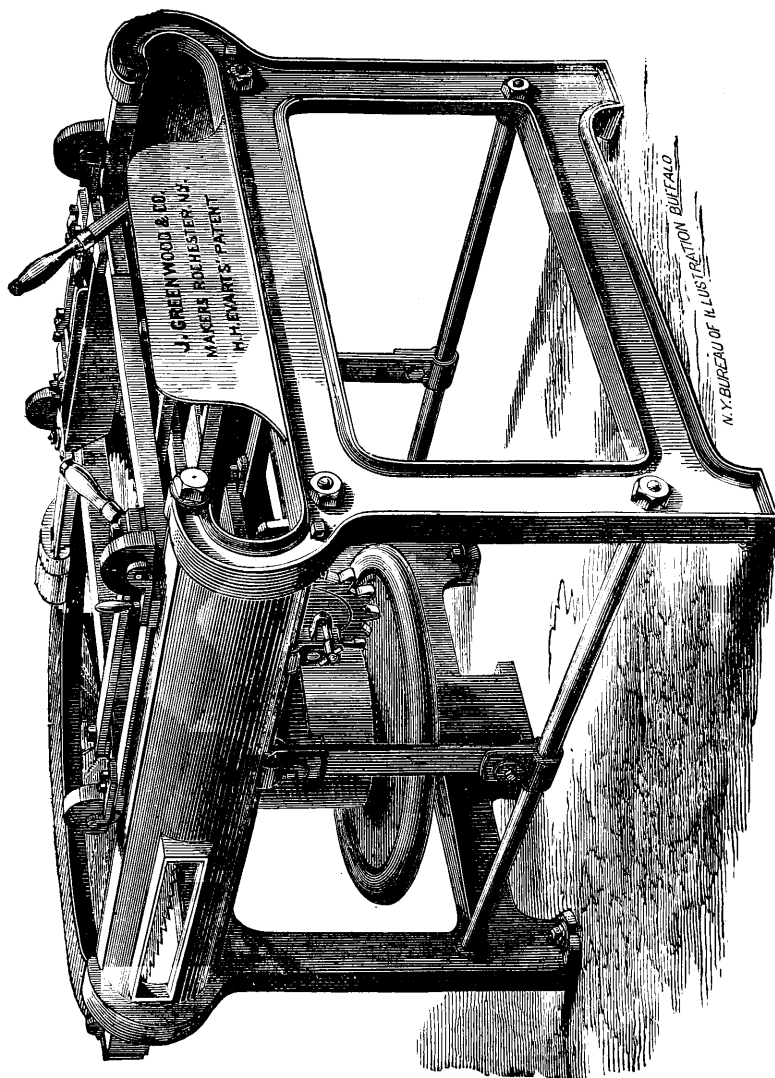

Evart's Patent Heading and Shingle Sawing Machine, with J. Greenwood's Improved Self-Setting Arrangement for Shingles.

J. GREENWOOD.

S. TEAL.

JOHN GREENWOOD & CO.,

MANUFACTURERS OF

Barrel Machinery,

GREENWOOD'S BUILDING,

No. 124 Mill Street, - Rochester, N. Y.

FRANK S. UPTON,
President and Treasurer.

S. B. UNDERHILL,
Vice-President.

J. MILLER KELLY,
Secretary.

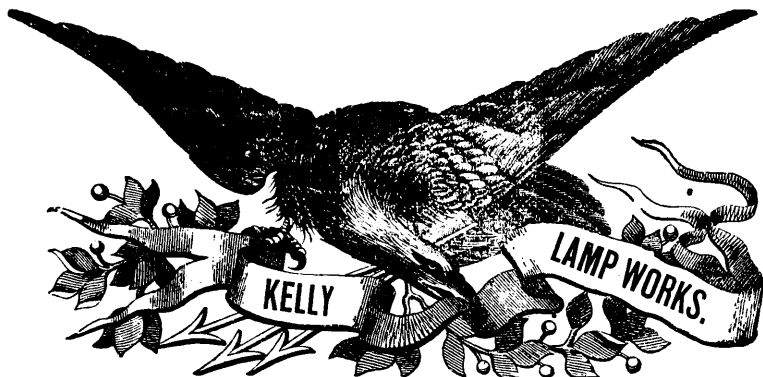

Kelly Lamp Works,

ROCHESTER, N. Y.
AND 192 FULTON STREET, NEW YORK.
Manufacturers of

Locomotive Head Lamps,

NICKEL PLATED, GERMAN SILVER and BRASS
CONDUCTOR LAMPS,
—AND—

LOOSE GLOBE RAILROAD HAND LANTERNS.

**Hand Lamps or
Lanterns for Rail-
road Men, Livery
Men, Hotel Men,
Farmers, Mechan-
ics. In short, Lamps
and Lanterns suit-
able to be used for
any business.**

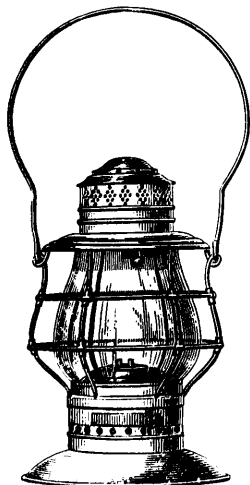

MONITOR No. 2.
(CLOSED.)

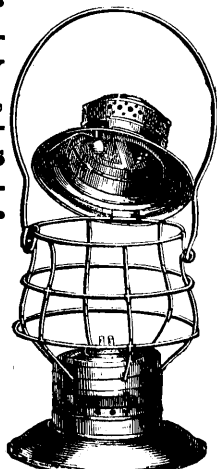
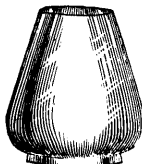

MONITOR No. 2.
(OPEN.)

JAMES H. KELLY, General Agent.

L. S. GRAVES,

Mill Street, cor. Factory St., Rochester, N. Y.,

MANUFACTURER AND DEALER IN ALL KINDS OF

BOOT & SHOE MACHINERY,

Shafting, Pulleys, Hangers, etc.

As an addition to the BOOT AND SHOE MACHINE WORKS, we have lately commenced the manufacture of

Hand & Power Elevators,

For FACTORIES, WAREHOUSE and PASSENGER use. Combining the most approved MECHANICAL PRINCIPLES and DEVICES, for SAFETY, DURABILITY, NOISELESS RUNNING and ECONOMY OF POWER.

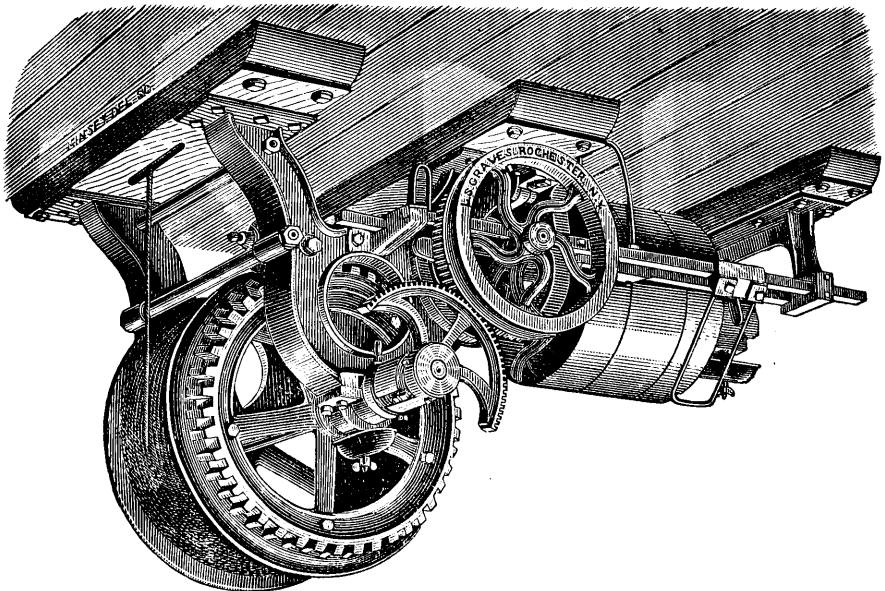

POWER SAFETY HOISTING MACHINE.

With several years' experience in putting up and repairing Elevators, as agent for OTIS BROS. & Co. of New York, and with the best of tools and facilities for manufacturing, I am prepared to build and put up Elevators which I can warrant PERFECTLY SAFE and first-class in every respect, and at reasonably low prices. Parties in want will do well to examine my elevators running before purchasing elsewhere.

**Patronize your Home Institutions before you
Insure with Foreign Companies.**

Rochester German Insurance Co.,

OF ROCHESTER, N. Y.

Chartered, 1872.

Office, Rochester Savings Bank Building.

Assets, January 1, 1876, - - \$344,498.88
Cash Capital, - - - - - 200,000.00

OFFICERS.

PRESIDENT, - - - - -	FRED'K COOK.
VICE PRESIDENT, - - - - -	HON. JOHN LUTES.
SECRETARY, - - - - -	RUDOLPH VAY.

BOARD OF DIRECTORS.

Committee on Finance.

Fred'k Goetzman,
J. J. Bausch,
Henry Brinker,
John Lutes, Ex-mayor.
George C. Maurer.

Committee on Insurance.

John G. Wagner,
Fred'k Miller,
Michael Neuhart,
John Weis,
Christian Yaky.

Committee on Claims and Losses.

Joseph Schutte,
Wm. Graebe,
Matthias Kondolf,
Charles Rau,
Louis Wehn.

Committee on Agencies.

Louis Ernst,
John Dufner,
John Groh,
George C. Maurer,
Caspar Wehle.

Companies Represented.

BUFFALO GERMAN INS. CO., of Buffalo, N. Y.,
Cash Capital, \$200,000.00; Assets, Jan'y 1, 1876, \$6 4,960.33.

HOFFMAN INS. CO., of New York,
Cash Capital, \$200,000.00; Assets, Jan'y 1, 1876, \$414,492.00.

THE MERCANTILE AGENCY,

R. G. DUN & CO.,

15 EXCHANGE ST., ROCHESTER, N. Y.

CHAS. C. OWENS, Manager.

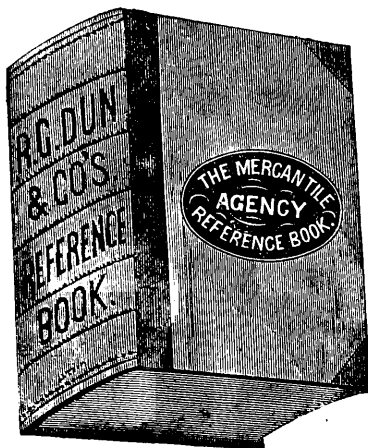

We respectfully announce that
A Revised Edition of our Reference Book.
 Containing the
NAMES, BUSINESS, WORTH AND CREDIT STANDING OF
700,000 TRADERS,
 is issued on the
FIRST DAY OF JANUARY, MARCH, JULY AND SEPTEMBER.

The MERCANTILE AGENCY has been in successful operation for about thirty-five years, and was

The First Organization of the kind established in America for the Promotion and Protection of Trade.

The yearly extension of its operations, the ever-increasing patronage it attracts and retains, are evidences of its efficiency and success. It has stood the test of time and overcome many difficulties and prejudices, and at no period since its origin has it exercised such important functions in commercial affairs as now. There are

SEVENTY-ONE BRANCH OFFICES,

under one general management, and co-operating for a common end. Each has a well-appointed management and a certain district assigned, which is periodically revised by its own travelers. It is in this manner that we are enabled to report thoroughly and exhaustively the ENTIRE UNITED STATES and BRITISH NORTH AMERICA, our Agents accepting only that information which has been endorsed by well-posted authorities, and the points in which referring to REAL ESTATE, MORTGAGES, JUDGMENTS, &c., have been obtained from official sources. We are also promptly informed of all changes by our numerous resident correspondents. The rapid growth of our business and the magnitude of our organization, stamp us as pre-eminently THE AGENCY. It is the only one, which, by its

LEGITIMATE RESOURCES AND HIGH POSITION,

commends itself to the full confidence and patronage of the public. We leave no effort unspent to do justice to the Wholesale Trader, Banker and Manufacturer, who seeks our information, by thorough, efficient and unprejudiced reports of those with whom they transact business.

LIST OF OFFICES:

HEAD OFFICE,

DUN, BARLOW & CO.

BRANCHES:

- | | | | |
|--------------------|---------------------|---------------------|--------------------|
| ALBANY, N. Y. | EVANSVILLE, Ind. | NEW ORLEANS, La. | TROY, N. Y. |
| ATLANTA, Ga. | GALVESTON, Texas. | NORFOLK, Va. | UTICA, N. Y. |
| BALTIMORE, Md. | GLOVERSVILLE, N. Y. | PHILADELPHIA, Pa. | WILLIAMSPORT, Pa. |
| BINGHAMPTON, N. Y. | GRAND RAPIDS, Mich. | PITTSBURGH, Pa. | LONDON, Eng. |
| BUFFALO, N. Y. | HARTFORD, Conn. | PORTLAND, Oregon. | MANCHESTER, Eng. |
| BURLINGTON, Iowa. | HOUSTON, Texas. | PROVIDENCE, R. I. | GLASGOW, Scotland. |
| CHARLESTON, S. C. | INDIANAPOLIS, Ind. | QUINCY, Ill. | PARIS, France. |
| CHICAGO, Ill. | KANSAS CITY, Mo. | RICHMOND, Va. | LEIPZIG, Germany. |
| CINCINNATI, Ohio. | KEOKUK, Iowa. | ROCHESTER, N. Y. | MONTREAL, Ont. |
| CLEVELAND, Ohio. | LACROSSE, Wis. | ST. JOSEPH, Mo. | TORONTO, Ont. |
| COLUMBUS, Ohio. | LEAVENWORTH, Kan. | ST. LOUIS, Mo. | HAMILTON, Ont. |
| DALLAS, Texas. | LOUISVILLE, Ky. | ST. PAUL, Minn. | LONDON, Ont. |
| DAVENPORT, Iowa. | MEMPHIS, Tenn. | SAN FRANCISCO, Cal. | HALIFAX, N. S. |
| DAYTON, Ohio. | MILWAUKEE, Wis. | SAVANNAH, Ga. | ST. JOHN, N. B. |
| DENVER, Col. | MOBILE, Ala. | SCRANTON, Pa. | BOSTON, Mass. |
| DETROIT, Mich. | NASHVILLE, Tenn. | SYRACUSE, N. Y. | PORTLAND, Me. |
| DUBUQUE, Iowa. | NEWARK, N. J. | TOLEDO, Ohio. | WORCESTER, Mass. |
| ERIE, Pa. | NEW HAVEN, Conn. | | |

For the COLLECTION OF DEBTS and the FURNISHING OF RELIABLE INFORMATION, WE POSSESS FACILITIES THAT ARE UNEQUALLED, and which enable us, confidently, to ask the support and patronage of the Mercantile Community. Respectfully,

R. G. DUN & CO.

COURT STREET FOUNDRY.

N. H. GALUSHA,

MANUFACTURER AND DEALER IN

STOVES and RANGES of every description, Hollow Ware, Scotch Bowls, Caldron Kettles, Miscellaneous Castings,

Dealers in SCOTCH and No. 1 AMERICAN PIG IRON.

No Better Working Range Made; of Full Weight, and at a Lower Price than any Range in the Market.

“PERFECT” RANGE.

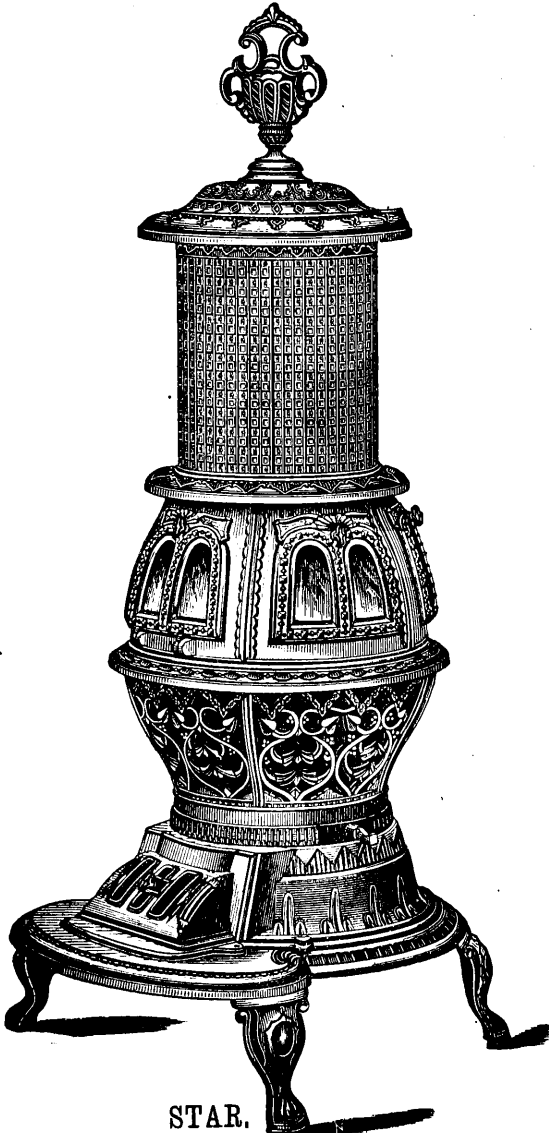

STAR.

“PERFECT,” “STAR,” “CHIEF.”

Three New Ranges,

Dealers will find it advantageous to get prices before purchasing elsewhere. SEND FOR A PRICE LIST.

No. 20 Court, near South St. Paul Street, - Rochester, N. Y.

C. D. PAGE'S Hydraulic Water Wheel,

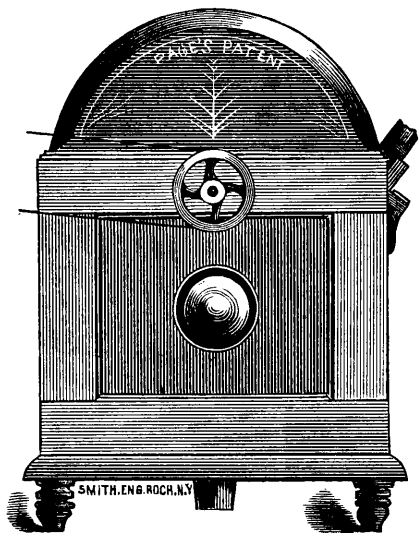

TO BE USED FOR ALL
LIGHT POWER,

IN CONNECTION TO THE
Hemlock and other Water Works

BY SIMPLY

TAPPING MAIN PIPES

—WITH—

SMALL GAS PIPE
To Wheel.

—PRICE:

32 Inch Wheel,	- - -	\$100 00
20 " "	- - -	50 00
11 " "	- - -	20 00

—ALSO,—

Patented Evaporating Parlor Stand,

—FOR—
SUPPLYING MOISTURE
—TO—
Heated Air.

Patented 1874.

This Stand is set directly over the Register of the Furnace. A healthy humidity of the atmosphere in the room is easily maintained.

PRICE—From \$20 to \$35 and \$40.

Send for Pamphlets.

—ALSO,—

PAGE'S
Patented Chemical Water-Flame Draw
LIME KILN.

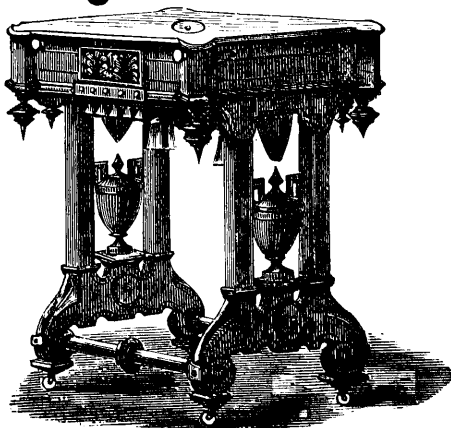

Will burn *No. 1 LIME*, either with Coal or Wood, without any alteration, and with 35 per cent. less fuel than any other Kiln now known.

OFFICE:

No. 17 East Street, - - - Rochester, N. Y.

C. D. PAGE.

THE JOHNSTON HARVESTER COMPANY, OF BROCKPORT, N. Y.

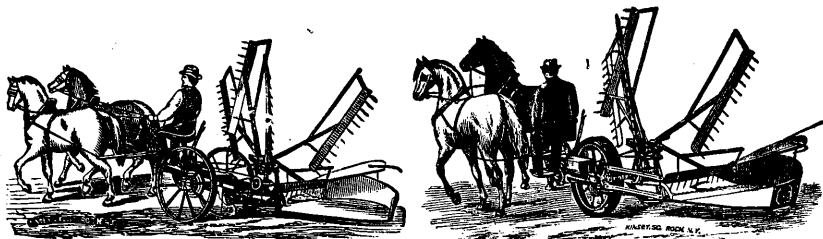

THIS COMPANY have for many years built and put upon the markets of the world their peculiar MACHINES FOR CUTTING GRASS and HARVESTING GRAIN, which have from the beginning taken the FIRST place among all those manufactured for that purpose.

They have been tested by scientific Machinists, by casual observers, and by practical Farmers, and always with one and the same result, namely,

The First Award for Excellence of Workmanship and Quality of Work Done in the Field.

They stand AT THE HEAD of the whole family of Harvesting Machines, and although attempts have been made to copy them by many other manufacturers, still the *Original* stands superior to all, and cannot be displaced.

In 1874, they took **TWENTY GOLD MEDALS**, and nearly as many MEDALS OF HONOR from fields in foreign countries alone, and the FIRST AWARD, being a Gold Medal, at the Cincinnati Exposition.

In 1875, they were equally successful in bringing home Gold Medals, besides the far better encomiums of the ROYAL AGRICULTURAL SOCIETY OF FRANCE, which ordered one of them tested through the *whole season* instead of for a short trial of a few days, and then examined by expert machinists, who pronounced it the BEST MADE, MOST DURABLE and MOST EFFICIENT MACHINE IN THE FIELD.

FARMERS AND DEALERS

who wish to obtain the BEST will certainly examine the Machines of *The Johnston Harvester Company*, before purchasing elsewhere.

Their Machines consist as follows:

The Single Reaper, 6 feet cut, for Reaping only.

The Single Reaper, 5 feet cut, for Reaping only.

The Improved Wrought Iron Harvester, a most excellent machine, for Reaping only.

The No. 1 Combined Machine, a most superb and complete Machine, for either Mowing or Reaping, built in the most substantial manner and having two cutter-bars, one for reaping and one for mowing.

The No. 2 Combined Machine, a smaller Machine, having only one bar, which is used for both reaping and mowing, and is of very light draft.

The Wrought Iron Mower, which is pronounced by those who have used it, the best mower in the market.

Every pains taken to please our customers, and all our machines WARRANTED.

Send for Circulars, and address

THE JOHNSTON HARVESTER CO.,

BROCKPORT, N. Y.

BRANCH OFFICES:

London, Eng.; Hamburg; Paris; Chicago, Ill.; Cleveland, Ohio; Jackson, Mich.

HOWARD IRON WORKS,

BUFFALO, N. Y.,

MANUFACTURERS OF

PATENT SAFETY HOISTING MACHINERY,

Hand and Power Elevators,

— FOR —

MANUFACTORIES, HOTELS, STORES, &C.

SCHLENKER'S BOLT CUTTERS,

Printers' and Bookbinders' Machinery,

HOWARD PARALLEL BENCH VISE,

Bark Mills, and Tannery Fixtures of all kinds, &c.

FOREST HOUSE,

On the way to the Bay, Newport House and the Sea Breeze,

IRONDEQUOIT.

ERNEST FRANKE, Proprietor.

This House has a SPACIOUS HALL for the accommodation of parties wishing to enjoy a Social Dance during the day or evening.

Meals Served and Parties Waited Upon at all Seasonable Hours.

STREET NUMBERS

FOR SALE AT

DIRECTORY OFFICE, - 114 Powers' Buildings.

White Metal Figures,	Height 1½ inches.	Silver Close Plated Figures,	Height 2 inches.
Nickel Plated "	" 2 "	Enameled Tin, Gold "	" 2 "
Electro-Silver Plated Figures,	" 2 "	Prices, 10c. to 50c. Per Figure.	

—ALSO,—

Engraved Silver Door Plates and Numbers,

OF SUPERIOR QUALITY AND WORKMANSHIP.

DREW, ALLIS & CO.

THE LEIGHTON

Bridge & Iron Works,

Works and Office Located at East Rochester, N. Y.

THOMAS LEIGHTON, - Owner and Manager.

Office Hours, from 12 to 1, at City Bank, 34 State St.

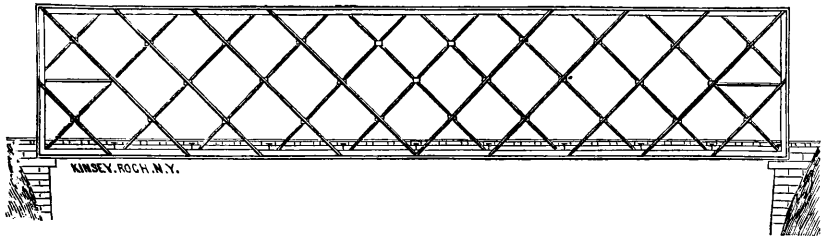

CONTRACTOR FOR

WROUGHT IRON

RAILROAD AND HIGHWAY BRIDGES,

Plate Girders,

WROUGHT IRON WATER PIPE,

And General Wrought Iron Work.

Long Span Bridges a Specialty.

Style of Bridge Manufactured:

“THE AMERICAN RIVETED LATTICE.”

BRANCH OFFICE, - - ALBANY, N. Y.

CHAS. HILTON, C. E., Agent.

Strangers wishing to reach the Office should go directly out East Main Street to the City Limits.

STREET NUMBERS

FOR SALE AT
DIRECTORY OFFICE,

No. 114 Powers' Buildings, - Rochester, N. Y.

White Metal Figures, - - - - -	Height, 1½ inches.
Nickel Plated Figures, - - - - -	“ 2 “
Electro-Silver Plated Figures, - - - - -	“ 2 “
Silver Close Plated Figures, - - - - -	“ 2 “
Enameled Tin, Gold Figures, - - - - -	“ 2 “

Prices. 10c. to 50c. Per Figure.

—ALSO,—

Engraved Silver Door Plates & Numbers,

OF SUPERIOR QUALITY AND WORKMANSHIP.

DREW, ALLIS & CO.

DWIGHT PALMER,

Wholesale and Retail Dealer in

KEG, CAN, COUNT AND

BULK OYSTERS,

ALL KINDS OF

FRESH FISH,

Lobsters, Clams,
SCOLLOPS,
Pickled Pigs' Feet,

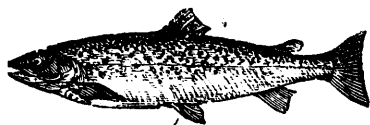

TONGUE and TRIPE,

No. 76 Front Street, - Rochester, N. Y.

PITTSTON SOFT COAL.

C. A. PHILLIPS & CO.,

No. 1 Arcade Hall, opp. Dewey's Bookstore.

A. G. SPRINGER, 177 South St. Paul Street.

JOHN A. VAN INGEN, Buffalo Street Swing Bridge.

J. W. PHILLIPS, Smith Street, next to R. R. Bridge.

SOFT COAL at Wholesale and Retail.

WARRANT & SOUTHWORTH,

ESTABLISHED IN 1841,

26 South St. Paul Street, - Rochester, N. Y.

Have for sale for 1876 the Largest Assortment of new first-class

RANGES

Cooking and Parlor Stoves

That have ever been offered for sale in Rochester.

In our list of the very Latest and the most Celebrated Stoves and Ranges can be found the following :

Cooking Stoves,

CUNARD,
SUPERIOR.

RANGES.

BELMONT,
LION,
PERFECT.

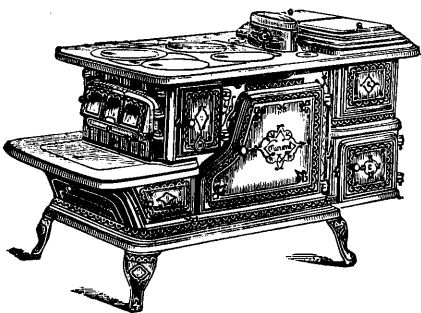

Parlor Stoves,

NEW
SUPERIOR,
NEW
AMERICAN.
ARGAND.

And other New and Approved Cooking and Parlor Stoves too numerous to mention.

☞ Reasonable Satisfaction guaranteed in all cases or the Money Refunded.

A general Assortment of

HOUSE FURNISHING GOODS,

Cutlery, Nails, &c.

COPPER, BRASS, TIN and SHEET-IRON WORK of every description,
made and repaired in the most Workmanlike Manner.

J. W. WARRANT.

J. B. SOUTHWORTH.